

Automation system CPX-AP-A

FESTO

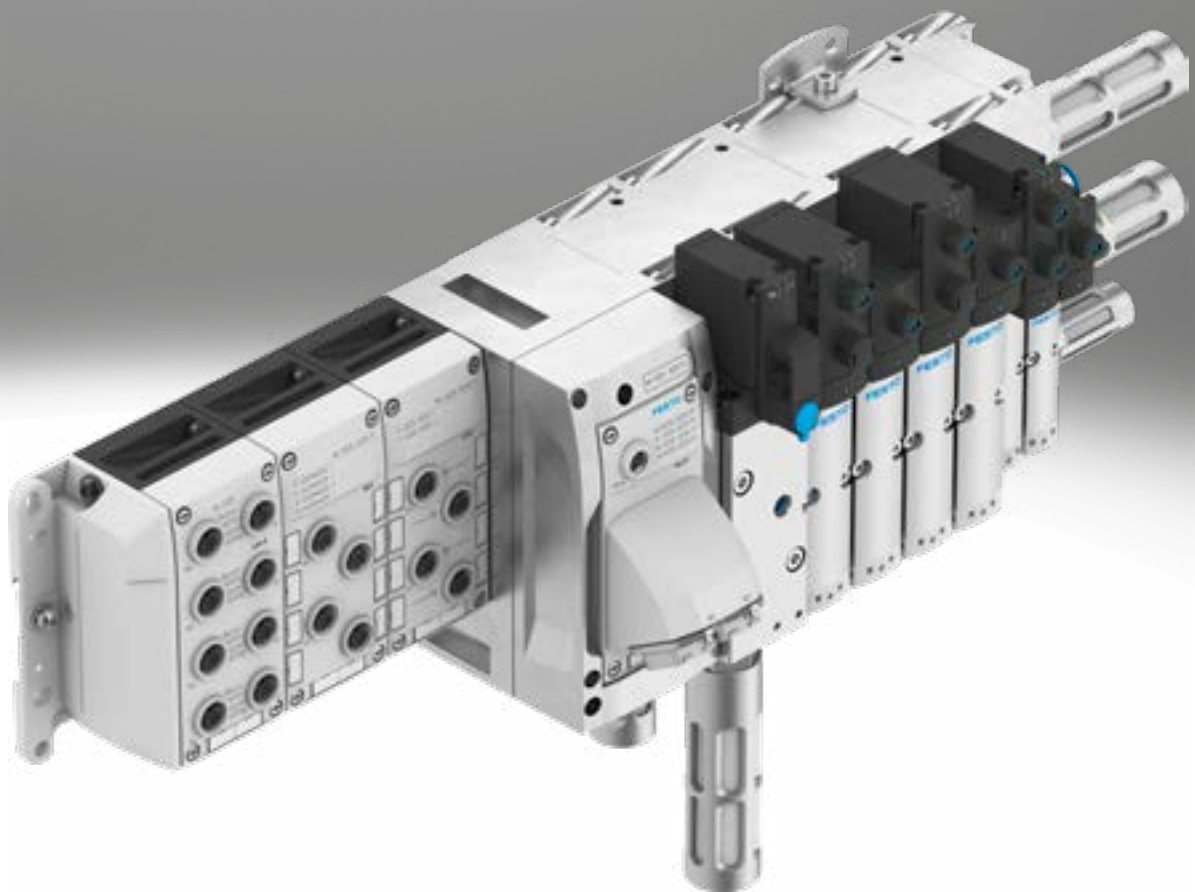

Key features

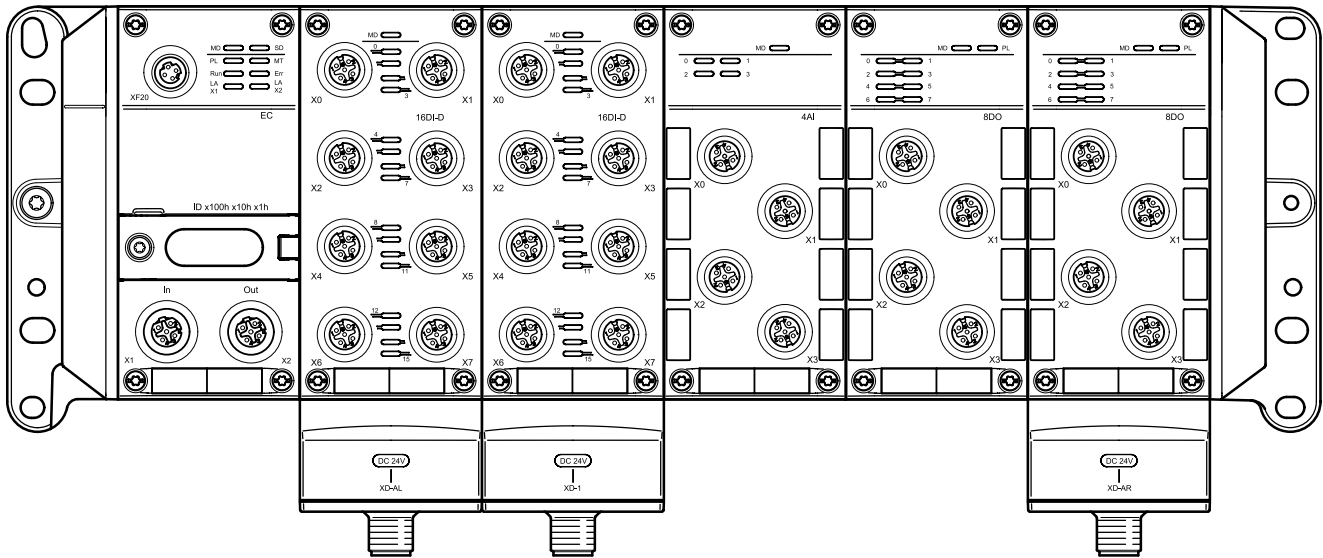

Key features

- Modular and lightweight IO system with IP65/IP67 protection
- Can be adapted to Festo valve terminals
- Highly flexible remote IO system with maximum performance
- Real-time capability, transmission rate of 200 Mbps full duplex
- Parameterisable and scalable
- Up to 15 modules in one automation system CPX-AP-A
- Linkages are connected using angled fitting
- Complete IO-Link master V1.1 with data storage mechanism including device parameterisation tool
- Dedicated data channel for acyclic data (events, diagnostics, parameters) which will be used for big data (status data for connected peripherals) without influencing the deterministic behaviour of the system.
- Transmission of the cyclic process data independently of the non-time-critical data.
- Easily integrated into standard host systems
- Extended diagnostics and predictive maintenance information available, such as valve switching cycle counter and cable quality monitoring
- Presentation of I4.0 features
- Integrated web server
- Festo Automation Suite plug-in for extended engineering and diagnostics
- Easy to mount in any position on any mounting wall using end plates or ITEM profiles and H-rail. Suitable for motion applications with high g-forces (up to 5 g)
- Suitable for robot applications
- Separate power supply and communications cable for establishing voltage zones (additional supply possible for every module)
- Stable data transfer and sturdy thanks to use of standard cables
- 16 A acceptable current load/logic at 24 V DC
- Potential-separated output channels
- Digital electronic rating plate available
- Commissioning using normal tools from the PLC manufacturer or with the Festo Automation Suite
- High level of EMC
- eoeFlame-retardant, halogen-free material (idea for welding applications)

Ordering data – Product options

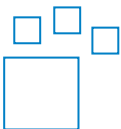

Configurable product

This product and all its product options can be ordered using the configurator.

The configurator can be found at

→ www.festo.com/catalogue/...

Enter the part number or the type.

Part no.	Type
8079933	CPX-AP-A
8000800	VTUX-A-P
8130719	VTSA-F-FB-AP
8130722	VTSA-F-CB-AP
8130716	VTSA-FB-AP
550808	MPA-FB-AP-VI

Key features

Overview

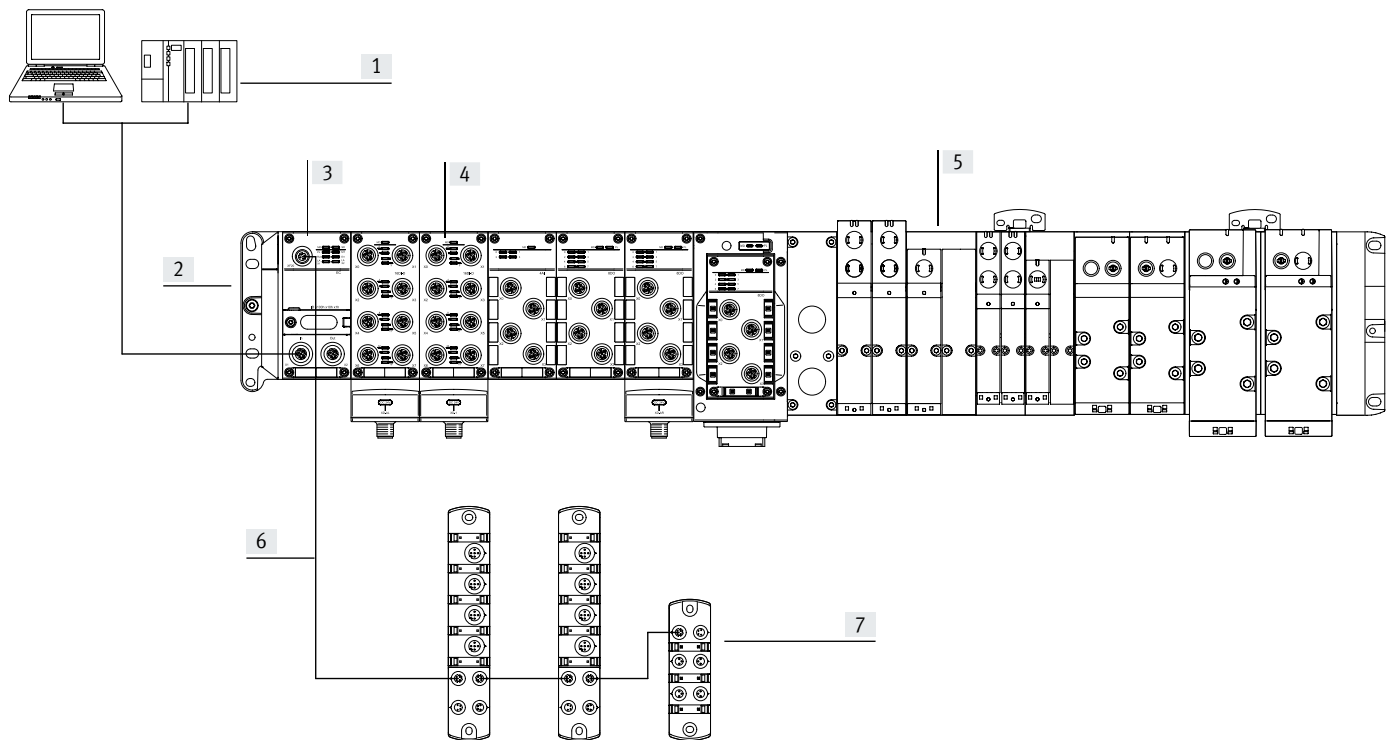



[1] Higher-order controller
 [2] Automation system CPX-AP-A
 [3] Bus interface for connecting the automation system CPX-AP-A to a higher-order controller via a standard bus protocol such as PROFINET

[4] Input module, output module or input/output module; allows sensors and actuators to be connected to the automation system CPX-AP-A. Up to 15 modules per terminal possible.

[5] Valve terminal with pneumatic interface for CPX-AP-A. Behaves like an output module within the automation system CPX-AP-A.

[6] Connecting cable for communication with further components via AP interface
 [7] Further components with AP interface

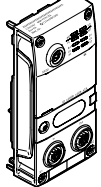
Product range overview

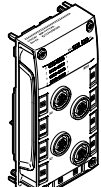
Function	Version	Type	→ Page			
Bus interface		PROFINET CPX-AP-A-PN-M12 CPX-AP-A-PN-CU	<ul style="list-style-type: none"> • Actuation via PROFINET • Two PROFINET connections • One connection for system communication • Connection technology RJ45 or M12x1 D-coded 	15		
		EtherCAT®	CPX-AP-A-EC-M12	<ul style="list-style-type: none"> • Actuation via EtherCAT • Two EtherCAT connections • One connection for system communication • Connection technology M12x1 D-coded 	20	
		EtherNet/IP	CPX-AP-A-EP-M12	<ul style="list-style-type: none"> • Actuation via EtherNet/IP • Two Ethernet connections • One connection for system communication • Connection technology M12x1 D-coded 	24	
IO-Link master		4 IO-Link connections	CPX-AP-A-4IOL-M12	<ul style="list-style-type: none"> • LED indicator • Master V 1.1 	28	
Input module		Digital	8 inputs	CPX-AP-A-8DI-M12-5P	<ul style="list-style-type: none"> • LED indicator • Diagnostics per module • PNP (positive switching) • Characteristic curve of inputs to IEC 61131-2, type 3 • Electrical connection M12x1, 5-pin 	32
			16 inputs	CPX-AP-A-16DI-D-M12-5P	<ul style="list-style-type: none"> • LED indicator • Diagnostics per channel • PNP (positive switching) • Characteristic curve of inputs to IEC 61131-2, type 3 • Electrical connection M12x1, 5-pin 	32
Output module		Digital	8 outputs	CPX-AP-A-8DO-M12-5P	<ul style="list-style-type: none"> • LED indicator • Diagnostics per channel • Diagnostics per module • PNP (positive switching) • Characteristic curve of outputs to IEC 61131-2, type 0.5 • Electrical connection M12x1, 5-pin 	36

Product range overview

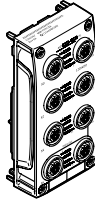
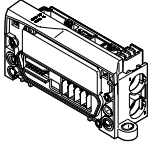
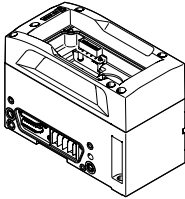
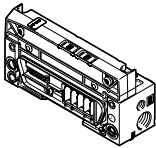
Function	Version	Type	→ Page	
Input/output module	Digital  <ul style="list-style-type: none"> • 12 inputs • 4 outputs 	CPX-AP-A-12DI4DO-M12-5P	<ul style="list-style-type: none"> • LED indicator • Diagnostics per channel (outputs only) • Diagnostics per module (outputs and inputs) • PNP (positive switching) • Characteristic curve of inputs to IEC 61131-2, type 3 • Characteristic curve of outputs to IEC 61131-2, type 0.5 • Electrical connection M12x1, 5-pin 	41
	Pneumatic interface for valve terminal Valve terminals VTUX  <ul style="list-style-type: none"> • Maximum of 32 valve positions • Up to 32 solenoid coils 	VABX-A-P-EL-E12-APA-SHUH	<ul style="list-style-type: none"> • LED indicator • 1 valve size (10 mm) • 2x 3/2-way valves • 5/2-way valves • 5/3-way valve • Flow rates up to 670 l/min 	60
Pneumatic interface for valve terminal	Valve terminals VTSA  <ul style="list-style-type: none"> • 12, 16, 24 or 32 valve positions • Up to 32 solenoid coils • 12, 16, 24 or 32 valve positions • Up to 32 solenoid coils • With integrated power supply and power transmission (optional) 	VABA-S6-1-X5 VABA-S6-1-X5-CB VABA-S6-1-X5-F3-CB VABA-S6-1-X5-F4 VABA-S6-1-X5-F4-CB	<ul style="list-style-type: none"> • LED indicator • 4 valve sizes (18 mm, 26 mm, 42 mm and 52 mm) • 2x 2/2-way valves • 2x 3/2-way valves • 5/2-way valves • 5/3-way valves • Wide range of special functions (switching position sensing, pilot air switching valve, soft-start valve, vacuum applications) • 550 ... 2900 l/min flow rate 	62
	Valve terminals MPA-S 	–	VMPA-AP-EPL-G VMPA-AP-EPL-E	<ul style="list-style-type: none"> • LED indicator • 3 valve sizes (10 mm, 14 mm and 20 mm) • 5/2-way valves • 2x 3/2-way valves • 5/3-way valves • 2x 2/2-way valves • 1x 3/2-way valves with external compressed air supply • Manual pressure regulators • Pilot air switching valve • Proportional pressure regulators • Pressure sensor • 360 ... 850 l/min flow rate

Key features – Mounting

Mounting

Wall mounting

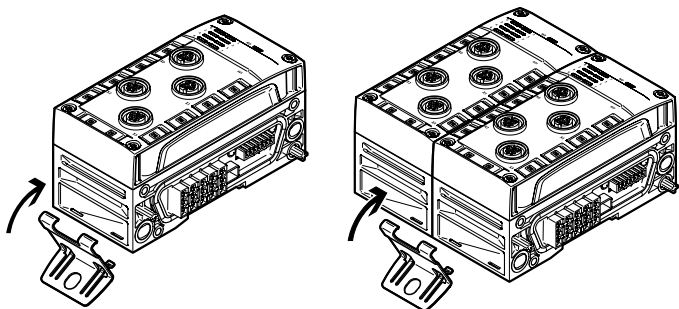

The end plates of the automation system, the valve terminal and the pneumatic interface include mounting holes for wall mounting.

For longer versions, there are additional mounting brackets for the interlinking blocks of the automation system. With more than 7 interlinking blocks, a mounting bracket is required every 15 cm (corresponds to 3 interlinking blocks).

The mounting brackets can be attached to one interlinking block or between two interlinking blocks.

H-rail mounting

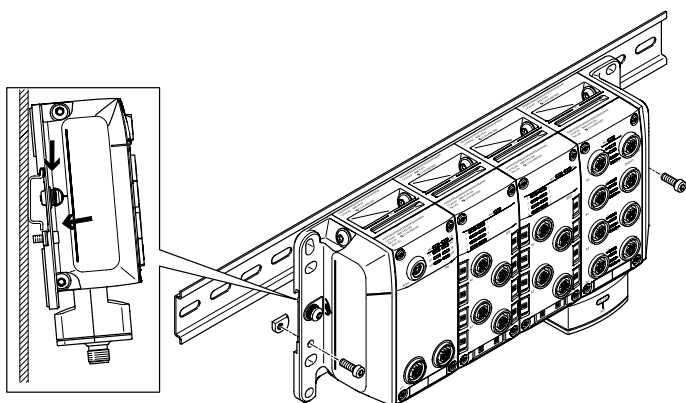

The H-rail mounting is part of the rear profile of the interlinking blocks, the end plates and the pneumatic interface. The automation system can be attached to the H-rail using the H-rail mounting kit.

The automation system is hooked onto the H-rail and

then swivelled onto the H-rail and secured in place with the clamping piece.

Mounting on support system with valve terminal VTSA/VTSA-F/VTSA-F-CB

When mounting on a support system, only the mounting holes in the end plates of the automation system, the valve terminal and in the pneumatic interface are available.

There is no option to use mounting brackets here, and the maximum number of interlinking blocks is limited to 6 (30 cm).

The corresponding mounting kit is required for the left-hand end plate.

Mounting on a support system without valve terminal is not envisaged.

Key features – Mounting

Mounting

Assembly

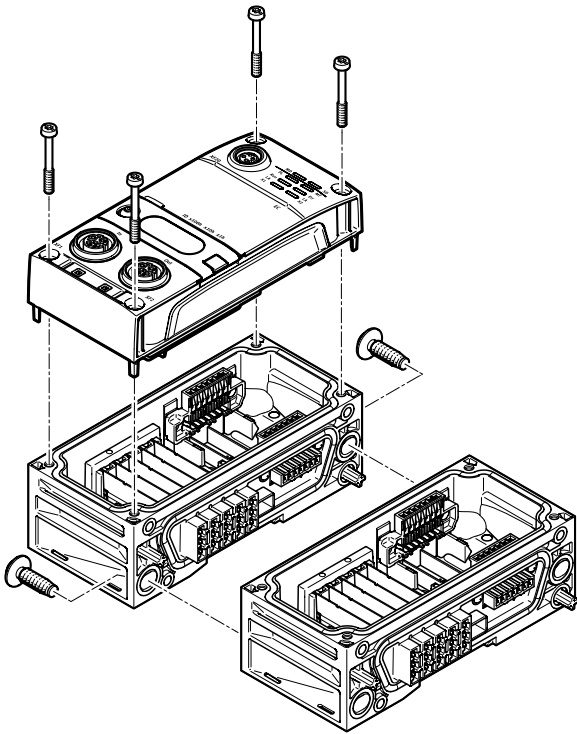

The interlinking blocks are mechanically connected using an angled fitting. The CPX terminal can thus be expanded at any time.

The advantages of polymer (low weight) and metal (sturdy, high EMC compatibility) are perfectly combined by using high-quality polymer materials.

Labelling

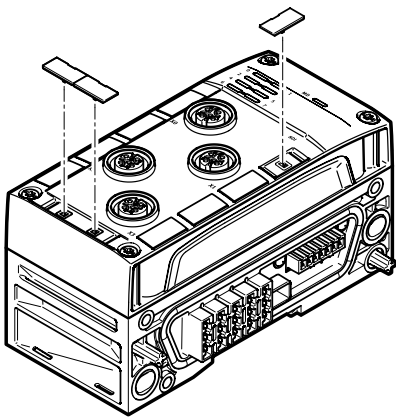

All modules are supplied with the same, clip-on inscription labels. The inscription label is made up of two parts and can be divided into two smaller units if required.

Labelling templates can be downloaded from the Support Portal:
 → Internet: CPX-AP-A
 In the “Software” area.

Key features – Power supply

Power supply concept

In principle, the automation system CPX-AP-A has two separate electrical circuits:

- For the module electronics and the power supply for connected sensors
- For connected outputs and valves

Interlinking blocks represent the backbone of the automation system with all supply cables.

They provide the power supply for the modules used on them as well as their bus connections.

The interlinking blocks enable either an easy-to-install central power supply for the entire automation system or galvanically isolated, all-pin disconnectable potential groups/voltage segments or power transmission.

Selectable connection technology:

- M18
- 7/8"
- M12x1, L-coded
- Push-pull to IEC 61076-3-126

System performance

Diagnostics

Detailed diagnostic functions are needed in order to quickly locate the causes of errors in the electrical installation and therefore reduce downtimes in the production plant.

A basic distinction is made between on-the-spot diagnostics using LEDs and diagnostics using a bus interface.

The automation system CPX-AP-A supports on-the-spot diagnostics using LED indicators on each module. This is separate from the connection area and therefore provides good visual access to status and diagnostic information.

Module and channel-specific diagnostics are supported, for example:

- Undervoltage detection
- Short circuit detection

The diagnostic messages can be read out via the bus interface in the higher-order controller and visualised for the central recording and evaluation of error causes. This is done using the individual bus-specific channels.

Indicator lights

Each module has a row of module-specific LEDs for indicating the operating status of the module and of the connected sensors or actuators.

Parameterisation

Various parameters are available for reading out information about the modules of the automation system CPX-AP-A and adapting the modules to the application situation.

The parameters are typically accessed via the higher-order controller.

Key features – Addressing

Addressing

The various modules of the CPX-AP-A occupy a different number of addresses within the CPX-AP-A system. The maximum address space for the bus interface depends on the performance of the fieldbus systems.

Maximum system configuration:

- 250 modules per AP string
- 1 bus interface
- 14 input and/or input/output modules and/or pneumatic interface per CPX-AP-A terminal

Addresses are allocated automatically. The bus interface is allocated the address "1", all other modules are assigned an address in increasing value from left to right, viewed from the bus interface.



Note

Please refer to the detailed description of the configuration/addressing rules in the technical data for the CPX-AP-A bus interface.

The maximum system configuration can be limited in individual cases by exceeding the address space or limitations of the higher-order controller.

Overview – Address space for CPX-AP-A bus interface

	Protocol	Max. total Inputs	Outputs
CPX-AP-A-PN-M12	PROFINET	1024 bytes	1024 bytes
CPX-AP-A-PN-CU	PROFINET	1024 bytes	1024 bytes
CPX-AP-A-EC-M12	EtherCAT®	1024 bytes	1024 bytes
CPX-AP-A-EP-M12	EtherNet/IP	4096 bytes	4096 bytes



Note

The bandwidth of the bus interface can be restricted by the choice of module and the maximum number of modules.

Overview – Allocated addresses for CPX-AP-A modules

		Inputs [bytes]	Outputs [bytes]
CPX-AP-A-4IOL-M12	IO-Link master	12 ... 132	8 ... 128
CPX-AP-A-8DI-M12-5P	Digital input module, 8 inputs	1	–
CPX-AP-A-16DI-D-M12-5P	Digital input module, 16 inputs	2	–
CPX-AP-A-8DO-M12-5P	Digital output module, 8 outputs	–	1
CPX-AP-A-12DI4DO-M12-5P	Digital input/output module, 12 inputs/4 outputs	2	1
VABX-A-P-EL-E12-APA-SHUH	Pneumatic interface to valve terminal VTUX, maximum 32 solenoid coils	–	4
VABA-S6-1-X5	Pneumatic interface to valve terminal VTSA, VTSA-F, maximum 32 solenoid coils	–	4
VABA-S6-1-X5-F4		–	4
VABA-S6-1-X5-CB		–	4
VABA-S6-1-X5-F3-CB		–	4
VABA-S6-1-X5-F4-CB	Pneumatic interface to valve terminal VTSA-F-CB, maximum 24 solenoid coils	–	4

Example of CPX-AP-A-PN-M12 (PROFINET)

	Inputs [bytes]	Outputs [bytes]	Remarks
8x CPX-AP-A-16DI-D-M12-5P	16	–	<ul style="list-style-type: none"> • The maximum number of modules is 15 CPX-AP-A modules • The available address space (1024 bytes) is not fully used up • Further modules can be configured via AP interface
2x CPX-AP-A-8DO-M12-5P	–	2	
3x CPX-AP-A-4IOL-M12	396	384	
1x VABA-S6-1-X5-F4	–	4	
Assigned address space	412	390	

Datasheet – Automation system



Central automation system for connecting sensors and controlling actuators and valves in an industrial environment.

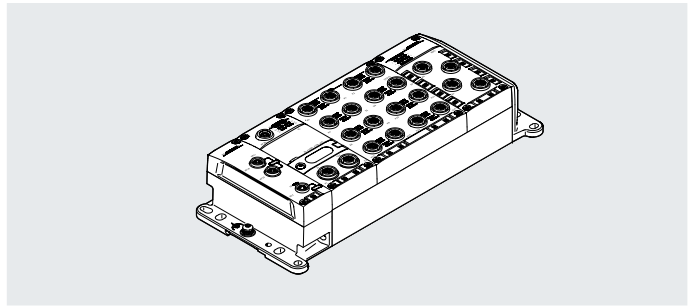

General technical data – Automation system

Protocol	AP
Electrical actuation	Ethernet
Max. number of modules	15
Max. address volume inputs	1024 byte 4096 byte
Note on inputs	EP: 488 bytes Modbus: 4096 bytes
Max. address volume for outputs	1024 byte 4096 byte
Note on outputs	EP: 496 bytes Modbus: 4096 bytes
Configuration support	EDS file ESI file GSDML file IODD file
Module parameters	Configuration of voltage monitoring load supply PL Behaviour after short circuit/overload at the output
Channel parameter	Activation diagnostics for IO-Link device lost Input debounce time Port mode Target deviceID Target vendorID Target cycle time
Internal cycle time	< 1 ms
Reverse polarity protection	Yes
Mounting position	Any, on H-rail: horizontal

Datasheet – Automation system

Diagnostic information – Automation system

Diagnosics via LED	(Outputs) Diagnostics per channel (Outputs) Power supply load (Inputs-Outputs) Diagnostics per module (Inputs-Outputs) Status per channel Diagnostics per channel Diagnostics per module EtherCAT RUN Ethernet/IP communication PROFINET communication Power supply, electronics/sensors Power supply load Status per channel Status per module System diagnostics Maintenance required
Diagnosics via bus	APDD invalid Load switch-off Communication error Electronics/sensors overvoltage Load overvoltage Electronics/sensors undervoltage Load undervoltage
Diagnosics via internal communication	Load switch-off IO-Link event Communication error Short-circuit/overload output signal Short circuit/overload in sensor supply Electronics/sensors overvoltage Load overvoltage Electronics/sensors undervoltage Load undervoltage

Datasheet – Automation system

Technical data – Automation system interfaces

Note on fieldbus interface	All information relevant for CPX-AP can be read out via the Ethernet/fieldbus interfaces and changed depending on the function; Auto MDI, the bus module does a crossover check; Firmware update via Ethernet/fieldbus interface; I&M functionality according to PNO is supported.
Fieldbus interface, protocol	ACD (Address Conflict Detection) DLR (Device Level Ring) EtherCAT® EtherCAT® CoE EtherCAT® Distributed Clocks (DC) EtherCAT® EoE EtherCAT® FoE EtherCAT® Modular Device Profile (MDP) EtherNet/IP EtherNet/IP QoS EtherNet/IP Quickconnect LLDP MRP, MRPD (ring redundancy) Modbus/TCP (Modbus/UDP) PROFINET FSU PROFINET I&MO .. 3 PROFINET IRT PROFINET RT PROFINET shared device S2 system redundancy SNMP
Fieldbus interface, function	Bus connection incoming/outgoing
Fieldbus interface, transmission rate	100 Mbps
Fieldbus interface, type	Ethernet
Fieldbus interface, type of connection	2 x socket
Fieldbus interface, connection technology	M12x1, D-coded to EN 61076-2-101 RJ45 to IEC 61076-3-117 (V14)
Fieldbus interface, number of pins/cores	4; 8
Fieldbus interface, galvanic isolation	Yes
Power supply, function	Incoming electronics/sensors and load and functional earth
Power supply, connection type	Plug
Power supply, connection technology	7/8" to NFPA/T3.5.29 M12x1, L-coded to EN 61076-2-111 M18x1 Push-pull to IEC 61076-3-126
Power supply, number of pins/wires	4; 5

Datasheet – Automation system

Technical data – Electrical, automation system

Nominal operating voltage DC for electronics/sensors	24 V
Nominal operating voltage DC load	24 V
Permissible voltage fluctuations, electronics/sensors	± 25%
Permissible voltage fluctuations, load	± 25%
Note on the operating voltage	SELV/PELV power supply units required; note voltage drop
Note on nominal operating voltage DC	Protected extra-low voltage to IEC 60204-1
Power failure buffering	10 ms
Max. power supply	8 ... 16 A
Typ. intrinsic current consumption at nominal operating voltage for electronic system/sensors	0.040 ... 10.000 A
Typ. intrinsic current consumption at nominal operating voltage, load	0.003 ... 10.000 A
Potential separation between the supply voltages electronics/sensors and load/valves	Yes
Protection class	III
Overvoltage category	II
Protection against direct and indirect contact	SELV/PELV power supply units required
Pollution degree	2

Mechanical technical data – Automation system

Type of mounting	Direct mounting via through-hole On H-rail via accessories On mounting frame Screw-clamped With through-hole for M5 screw with accessories With through-hole for M6 screw with accessories With through-hole for M5 screw With through-hole for M6 screw
Product weight	450 ... 5200 g
Dimensions W x L x H	Depending on the configuration
Grid dimension	50.1 mm

Materials – Automation system

Note on materials	RoHS-compliant; free of halogen; free of phosphoric acid ester
LABS (PWIS) conformity	VDMA24364-B2-L

Datasheet – Automation system

Operating and environmental conditions – Automation system

Ambient temperature	-20 ... 50 °C
Note on ambient temperature	Note ambient temperature derating according to IEC 61131-2:2017
Storage temperature	-20 ... 70 °C
Corrosion resistance class CRC ¹⁾	1 - Low corrosion stress
Relative humidity	5 - 95%, non-condensing
Nominal operating altitude	<= 2000 m ASL (> 79.5 kPa)
Max. setup altitude	3500 m
Note on max. setup altitude	> 2000 m ASL (< 79.5 kPa) Note ambient temperature derating according to IEC 61131-2:2017
Vibration resistance	Transport application test with severity level 2 to FN 942017-4 and EN 60068-2-6
Note on vibration resistance	SG1 on H-rail SG2 on direct mounting Transport application test with severity level 1 to FN 942017-4 and EN 60068-2-6
Shock resistance	Shock test with severity level 2 to FN 942017-5 and EN 60068-2-27
Note on shock resistance	30 g/11 ms to EN 60068-2-27 SG1 on H-rail SG2 on direct mounting Shock test with severity level 1 to FN 942017-5 and EN 60068-2-27
CE marking (see declaration of conformity) ²⁾	To EU EMC Directive, to EU-RoHS Directive
UKCA marking (see declaration of conformity) ³⁾	To UK EMC regulations; to UK RoHS regulations
Certification	RCM; c UL us - Listed (OL)
Certificate-issuing authority	UL E239998
Degree of protection	IP65; IP67
Note on degree of protection	Unused connections sealed

1) More information www.festo.com/x/topic/crc

2) More information www.festo.com/catalogue/... Support/downloads.

3) More information www.festo.com/catalogue/... Support/downloads.

Ordering data

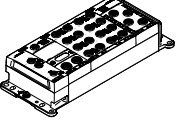
		Part no.	Type
	Automation system	8079933	CPX-AP-A
		Configurable product This product and all its product options can be ordered using the configurator.	

Datasheet – PROFINET interface



Interface for operating the automation system CPX-AP-A on PROFINET. Data is transferred on the basis of the Ethernet standard and TCP/IP technology for communication in an industrial environment.

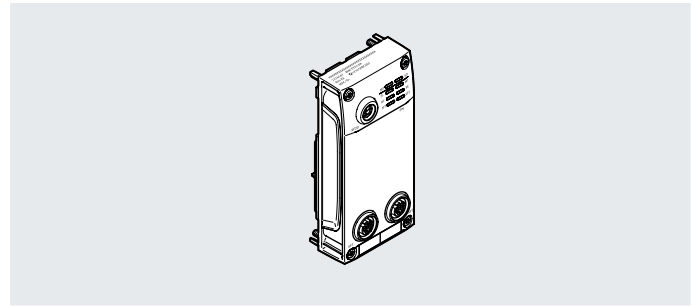

Bus connection

Communication with a higher-order controller takes place via PROFINET with real-time protocol (real time RT or isochronous real time IRT).

The bus connection is provided via two equivalent interfaces which meet Ethernet requirements.

The integrated switch supports star and line topology and enables the network to be divided into segments.

PROFINET implementation

The interface supports the PROFINET protocol on the basis of the Ethernet standard and TCP/IP technology to IEEE802.3.

This guarantees a data exchange with a high data transmission rate, for example I/O data from sensors, actuators or robot controllers, PLCs or process equipment.

In addition, non-real-time critical information such as diagnostic information, configuration information, etc. can be transmitted.

The Ethernet bandwidth is sufficient to transfer both data types (real-time and non-real-time) in parallel.

The interfaces support the PROFenergy profile for energy management. This makes it possible to switch off specific consumers that are not required in order to reduce energy demand.

The crossover detection function (Auto-MDI/MDI-X) is also supported. This means either patch cables or crossover cables can be used.

General technical data – PROFINET interface

Max. number of modules	80
Max. address volume inputs	1024 byte
Max. address volume for outputs	1024 byte
Configuration support	GSDML file
Module parameters	Configuration of voltage monitoring load supply PL
Diagnostics via LED	Diagnostics per module; PROFINET communication; power supply electronics/sensors; power supply load; system diagnostics; maintenance required
Diagnostics via bus	APDD invalid; switch-off load supply; communication error; overvoltage electronics/sensors; overvoltage load; undervoltage electronics/sensors; undervoltage load
Internal cycle time	< 1 ms
Reverse polarity protection	Yes
Max. cable length	100 m PROFINET
Mounting position	Any

Datasheet – PROFINET interface

Technical data – Electrical, PROFINET interface

Nominal operating voltage DC for electronics/sensors	24 V
Nominal operating voltage DC load	24 V
Permissible voltage fluctuations, electronics/sensors	± 25%
Permissible voltage fluctuations, load	± 25%
Note on the operating voltage	SELV/PELV power supply units required; note voltage drop
Note on nominal operating voltage DC	Protected extra-low voltage to IEC 60204-1
Power failure buffering	10 ms
Intrinsic current consumption at nominal operating voltage, electronics/sensors	Typical 80 mA
Intrinsic current consumption at nominal operating voltage, load	Typical 4 mA
Potential separation between the supply voltages electronics/sensors and load/valves	Yes
Protection class	III
Overvoltage category	II
Pollution degree	2

Technical data – Fieldbus interface, PROFINET interface

Fieldbus interface, connection technology	M12x1, D-coded to EN 61076-2-101	RJ45 to IEC 61076-3-117 (V14)
Fieldbus interface, protocol	LLDP; MRP, MRPD (ring redundancy); PROFINET FSU; PROFINET I&MO .. 3; PROFINET IRT; PROFINET RT; PROFINET shared device; S2 system redundancy; SNMP	
Fieldbus interface, function	Bus connection incoming/outgoing	
Fieldbus interface, transmission rate	100 Mbps	
Fieldbus interface, note on transmission rate	100 Mb, switched Fast Ethernet	100 Mb, switched; Fast Ethernet
Fieldbus interface, type	Ethernet	
Fieldbus interface, type of connection	2 x socket	
Fieldbus interface, number of pins/cores	4	8
Fieldbus interface, galvanic isolation	Yes	

Technical data – Communication interface, PROFINET interface

Communication interface, protocol	AP
Communication interface, function	System communication XF20 OUT
Communication interface, connection type	Socket
Communication interface, connection technology	M8x1, D-coded to EN 61076-2-114
Communication interface, number of pins/wires	4
Communication interface, screened	Yes

Technical data – Mechanical, PROFINET interface

Fieldbus interface, connection technology	M12x1, D-coded to EN 61076-2-101	RJ45 to IEC 61076-3-117 (V14)
Type of mounting	Screw-clamped	
Product weight	108 g	167 g
Dimensions W x L x H	(incl. interlinking block); 50.1 mm x 107.3 mm x 57.5 mm	(incl. interlinking block); 50.1 mm x 107.3 mm x 94.2 mm
Grid dimension	50.1 mm	

Datasheet – PROFINET interface

Materials – PROFINET interface

Fieldbus interface, connection technology	M12x1, D-coded to EN 61076-2-101	RJ45 to IEC 61076-3-117 (V14)
Housing material	PC	
O-ring material	FPM	
Sealing material	–	NBR
Flange material	–	Nickel-plated die-cast zinc
Threaded sleeve material	High-alloy stainless steel	
Screw material	Nickel-plated steel	
Note on materials	RoHS-compliant; free of halogen; free of phosphoric acid ester	
LABS (PWIS) conformity	VDMA24364-B2-L	

Operating and environmental conditions – PROFINET interface

Ambient temperature	-20 ... 50 °C	
Note on ambient temperature	Note ambient temperature derating according to IEC 61131-2:2017	
Storage temperature	-20 ... 70 °C	
Corrosion resistance class CRC ¹⁾	1 - Low corrosion stress	
Relative humidity	5 - 95%, non-condensing	
Nominal operating altitude	<= 2000 m ASL (> 79.5 kPa)	
Max. setup altitude	3500 m	
Note on max. setup altitude	> 2000 m ASL (< 79.5 kPa) Note ambient temperature derating according to IEC 61131-2:2017	
Vibration resistance	Transport application test with severity level 2 to FN 942017-4 and EN 60068-2-6	
Note on vibration resistance	SG1 on H-rail SG2 on direct mounting Transport application test with severity level 1 to FN 942017-4 and EN 60068-2-6	
Shock resistance	Shock test with severity level 2 to FN 942017-5 and EN 60068-2-27	
Note on shock resistance	30 g/11 ms to EN 60068-2-27 SG1 on H-rail SG2 on direct mounting Shock test with severity level 1 to FN 942017-5 and EN 60068-2-27	
Material fire test	UL94 V-0 (housing)	

1) More information www.festo.com/x/topic/crc

Datasheet – PROFINET interface

Connection and display components

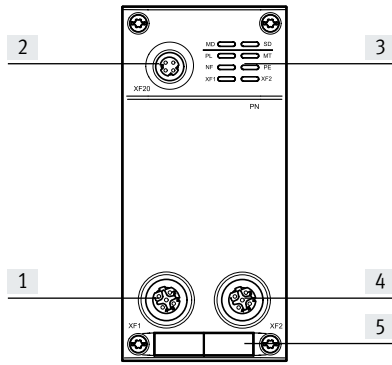

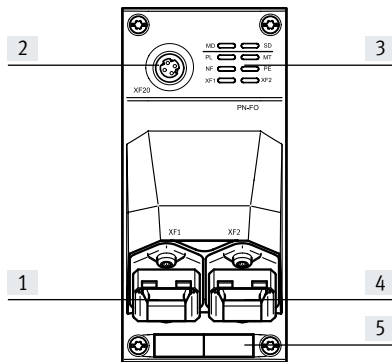

- [1] Network connection 1, PROFINET
- [2] Communication interface
- [3] LED indicators
- [4] Network connection 2, PROFINET
- [5] Space for inscription label



- [1] Network connection 1, PROFINET
- [2] Communication interface
- [3] LED indicators
- [4] Network connection 2, PROFINET
- [5] Space for inscription label

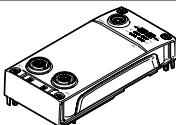

Datasheet – PROFINET interface

Ordering data		Fieldbus interface, connection technology	Part no.	Type
	PROFINET interface	M12x1, D-coded to EN 61076-2-101	8129241	CPX-AP-A-PN-M12
		RJ45 to IEC 61076-3-117 (V14)	8129245	CPX-AP-A-PN-CU

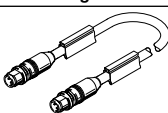
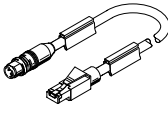
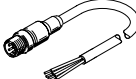
Ordering data – Accessories				
	Description	Pack size	Part no.	Type
Plug connectors for self-assembly				
	For bus connection	Straight plug, M12x1, 4-pin, D-coded	–	543109 NECU-M-S-D12G4-C2-ET
	For bus connection	RJ45 plug, 8-pin, push-pull	–	552000 FBS-RJ45-PP-GS

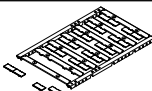
Connecting cables						
	Straight plug, M12x1, 4-pin, D-coded	Straight plug, M12x1, 4-pin, D-coded	0.5 m	–	8040446	NEBC-D12G4-ES-0.5-S-D12G4-ET
			1 m	–	8040447	NEBC-D12G4-ES-1-S-D12G4-ET
			3 m	–	8040448	NEBC-D12G4-ES-3-S-D12G4-ET
			5 m	–	8040449	NEBC-D12G4-ES-5-S-D12G4-ET
			10 m	–	8040450	NEBC-D12G4-ES-10-S-D12G4-ET
	Straight plug, M12x1, 4-pin, D-coded	Straight plug, RJ45, 8-pin	1 m	–	8040451	NEBC-D12G4-ES-1-S-R3G4-ET
			3 m	–	8040452	NEBC-D12G4-ES-3-S-R3G4-ET
			5 m	–	8040453	NEBC-D12G4-ES-5-S-R3G4-ET
			10 m	–	8040454	NEBC-D12G4-ES-10-S-R3G4-ET
	Straight plug, M12x1, 4-pin, D-coded	Open end, 4-wire	5 m	–	8040456	NEBC-LE4-ES-5-D12G4-ET

Inscription labels					
	For modules CPX-AP-A	Size 6 x 12.5 mm, 10 frames with 24 pieces each	240	8087174	ASLR-L-X4-612-P240

Cover cap					
	For sealing unused connections	For connection M8x1	10	177672	ISK-M8
		For connection M12x1	10	165592	ISK-M12
	For sealing unused connections	For RJ45 connection	–	548753	CPX-M-AK-C

Datasheet – EtherCAT interface



Interface for operating the automation system CPX-AP-A on EtherCAT. Data is transferred on the basis of the Ethernet standard for communication in an industrial environment.

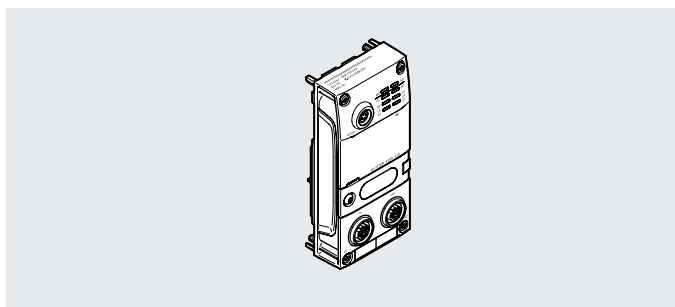

EtherCAT implementation

The interface supports the EtherCAT protocol based on the Ethernet standard and TCP/IP technology to IEEE802.3.

This guarantees a data exchange with a high data transmission rate, for example I/O data from sensors or actuators.

The integrated web server provides read and write access to the key parameters and diagnostic functions of the automation system CPX-AP.

The supported "Distributed Clocks" function, for precise synchronisation of stations in an EtherCAT network, enables applications that require simultaneously coordinated actions.

The crossover detection function (Auto-MDI/MDI-X) is also supported. This means either patch cables or crossover cables can be used.

General technical data – EtherCAT interface

Max. number of modules	80
Max. address volume inputs	1024 byte
Max. address volume for outputs	1024 byte
Configuration support	ESI file
Module parameters	Configuration of voltage monitoring load supply PL
Diagnostics via LED	Diagnostics per module; EtherCAT RUN; power supply electronics/sensors; power supply load; system diagnostics; maintenance required
Diagnostics via bus	APDD invalid; switch-off load supply; communication error; overvoltage electronics/sensors; overvoltage load; undervoltage electronics/sensors; undervoltage load
Internal cycle time	< 1 ms
Reverse polarity protection	Yes
Max. cable length	100 m EtherCAT
Mounting position	Any

Technical data – Electrical, EtherCAT interface

Nominal operating voltage DC for electronics/sensors	24 V
Nominal operating voltage DC load	24 V
Permissible voltage fluctuations, electronics/sensors	± 25%
Permissible voltage fluctuations, load	± 25%
Note on the operating voltage	SELV/PELV power supply units required; note voltage drop
Note on nominal operating voltage DC	Protected extra-low voltage to IEC 60204-1
Power failure buffering	10 ms
Intrinsic current consumption at nominal operating voltage, electronics/sensors	Typical 95 mA
Intrinsic current consumption at nominal operating voltage, load	Typical 3 mA
Potential separation between the supply voltages electronics/sensors and load/valves	Yes
Protection class	III
Overvoltage category	II
Pollution degree	2

Datasheet – EtherCAT interface

Technical data – Fieldbus interface, EtherCAT interface

Fieldbus interface, protocol	EtherCAT; EtherCAT CoE; EtherCAT Distributed Clocks (DC); EtherCAT EoE; EtherCAT FoE; EtherCAT Modular Device Profile (MDP)
Fieldbus interface, function	Bus connection incoming/outgoing
Fieldbus interface, transmission rate	100 Mbps
Fieldbus interface, note on transmission rate	100 Mb, switched Fast Ethernet
Fieldbus interface, type	Ethernet
Fieldbus interface, type of connection	2 x socket
Fieldbus interface, connection technology	M12x1, D-coded to EN 61076-2-101
Fieldbus interface, number of pins/cores	4
Fieldbus interface, galvanic isolation	Yes

Technical data – Communication interface, EtherCAT interface

Communication interface, protocol	AP
Communication interface, function	System communication XF20 OUT
Communication interface, connection type	Socket
Communication interface, connection technology	M8x1, D-coded to EN 61076-2-114
Communication interface, number of pins/wires	4
Communication interface, screened	Yes

Technical data – Mechanical, EtherCAT interface

Type of mounting	Screw-clamped
Product weight	113 g
Dimensions W x L x H	(incl. interlinking block); 50.1 mm × 107.3 mm × 57.5 mm
Grid dimension	50.1 mm

Materials – EtherCAT Interface

Housing material	PC
Cover material	Reinforced PBT
Inspection window material	PC
O-ring material	FPM
Threaded sleeve material	High-alloy stainless steel
Screw material	Nickel-plated steel
Note on materials	RoHS-compliant; free of halogen; free of phosphoric acid ester
LABS (PWIS) conformity	VDMA24364-B2-L

Datasheet – EtherCAT interface

Operating and environmental conditions – EtherCAT interface

Ambient temperature	-20 ... 50 °C
Note on ambient temperature	Note ambient temperature derating according to IEC 61131-2:2017
Storage temperature	-20 ... 70 °C
Corrosion resistance class CRC ¹⁾	1 - Low corrosion stress
Relative humidity	5 - 95%, non-condensing
Nominal operating altitude	<= 2000 m ASL (> 79.5 kPa)
Max. setup altitude	3500 m
Note on max. setup altitude	> 2000 m ASL (< 79.5 kPa) Note ambient temperature derating according to IEC 61131-2:2017
Vibration resistance	Transport application test with severity level 2 to FN 942017-4 and EN 60068-2-6
Note on vibration resistance	SG1 on H-rail SG2 on direct mounting Transport application test with severity level 1 to FN 942017-4 and EN 60068-2-6
Shock resistance	Shock test with severity level 2 to FN 942017-5 and EN 60068-2-27
Note on shock resistance	30 g/11 ms to EN 60068-2-27 SG1 on H-rail SG2 on direct mounting Shock test with severity level 1 to FN 942017-5 and EN 60068-2-27
Material fire test	UL94 V-0 (housing)



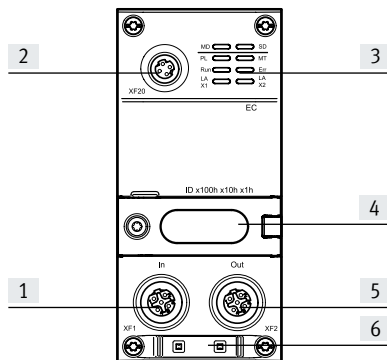

1) More information www.festo.com/x/topic/crc

Connection and display components

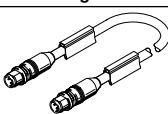
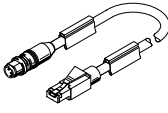
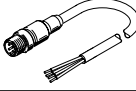
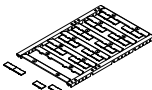

- [1] Network connection 1, EtherCAT
- [2] Communication interface
- [3] LED indicators
- [4] Rotary switch cover
- [5] Network connection 2, EtherCAT
- [6] Space for inscription label

Datasheet – EtherCAT interface

Ordering data		Part no.	Type			
	EtherCAT interface	8129243	CPX-AP-A-EC-M12			
Ordering data – Accessories						
Description		Pack size	Part no.	Type		
Plug connectors for self-assembly						
	For bus connection	Straight plug, M12x1, 4-pin, D-coded	–	543109	NECU-M-S-D12G4-C2-ET	
Connecting cables						
	Straight plug, M12x1, 4-pin, D-coded	Straight plug, M12x1, 4-pin, D-coded	0.5 m	–	8040446	NEBC-D12G4-ES-0.5-S-D12G4-ET
			1 m	–	8040447	NEBC-D12G4-ES-1-S-D12G4-ET
			3 m	–	8040448	NEBC-D12G4-ES-3-S-D12G4-ET
			5 m	–	8040449	NEBC-D12G4-ES-5-S-D12G4-ET
			10 m	–	8040450	NEBC-D12G4-ES-10-S-D12G4-ET
	Straight plug, M12x1, 4-pin, D-coded	Straight plug, RJ45, 8-pin	1 m	–	8040451	NEBC-D12G4-ES-1-S-R3G4-ET
			3 m	–	8040452	NEBC-D12G4-ES-3-S-R3G4-ET
			5 m	–	8040453	NEBC-D12G4-ES-5-S-R3G4-ET
			10 m	–	8040454	NEBC-D12G4-ES-10-S-R3G4-ET
	Straight plug, M12x1, 4-pin, D-coded	Open end, 4-wire	5 m	–	8040456	NEBC-LE4-ES-5-D12G4-ET
Inscription labels						
	For modules CPX-AP-A	Size 6x 12.5 mm, 10 frames with 24 pieces each	240	8087174	ASLR-LX4-612-P240	
Cover cap						
	For sealing unused connections	For connection M8x1	10	177672	ISK-M8	
		For connection M12x1	10	165592	ISK-M12	

Datasheet – EtherNet/IP interface

EtherNet/IP™

Interface for operating the automation system CPX-AP-A in an Ethernet network using the protocols EtherNet/IP or Modbus/TCP. Data is transmitted on the basis of Industrial Ethernet.

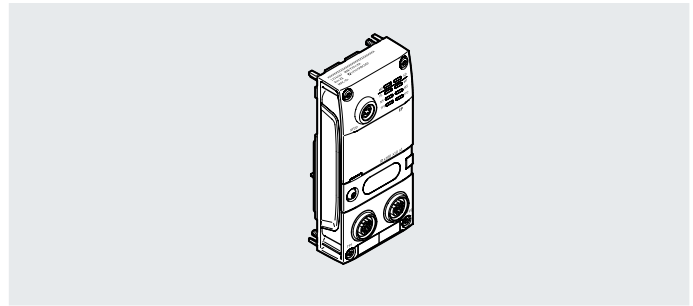

Implementation

EtherNet/IP and Modbus/TCP use the Ethernet standard and TCP/IP technology to IEEE802.3.

This guarantees a data exchange with a high data transmission rate, for example data from sensors, actuators or robot controllers, PLCs or process equipment.

In addition, non-real-time critical information such as diagnostic information, configuration information, etc. can be transmitted.

The Ethernet bandwidth is sufficient to transfer both data types (real-time and non-real-time) in parallel.

General technical data – EtherNet/IP interface

Max. number of modules	80
Max. address volume inputs	4096 byte
Note on inputs	EP: 488 bytes; Modbus: 4096 bytes
Max. address volume for outputs	4096 byte
Note on outputs	EP: 496 bytes; Modbus: 4096 bytes
Configuration support	EDS file
Module parameters	Configuration of voltage monitoring load supply PL
Diagnostics via LED	Diagnostics per module; Ethernet/IP communication; power supply electronics/sensors; power supply load; system diagnostics; maintenance required
Diagnostics via bus	APDD invalid; switch-off load supply; communication error; overvoltage electronics/sensors; overvoltage load; undervoltage electronics/sensors; undervoltage load
Internal cycle time	< 1 ms
Reverse polarity protection	Yes
Max. cable length	100 m Ethernet/IP
Mounting position	Any

Technical data – Electrical, EtherNet/IP interface

Nominal operating voltage DC for electronics/sensors	24 V
Nominal operating voltage DC load	24 V
Permissible voltage fluctuations, electronics/sensors	± 25%
Permissible voltage fluctuations, load	± 25%
Note on the operating voltage	SELV/PELV power supply units required; note voltage drop
Note on nominal operating voltage DC	Protected extra-low voltage to IEC 60204-1
Power failure buffering	10 ms
Intrinsic current consumption at nominal operating voltage, electronics/sensors	Typical 95 mA
Intrinsic current consumption at nominal operating voltage, load	Typical 3 mA
Potential separation between the supply voltages electronics/sensors and load/valves	Yes
Protection class	III
Overvoltage category	II
Pollution degree	2

Datasheet – EtherNet/IP interface

Technical data – Fieldbus interface, EtherNet/IP interface

Fieldbus interface, protocol	ACD (Address Conflict Detection); DLR (Device Level Ring); EtherNet/IP; EtherNet/IP QoS; EtherNet/IP Quickconnect; Modbus/TCP (Modbus/UDP); SNMP
Fieldbus interface, function	Bus connection incoming/outgoing
Fieldbus interface, transmission rate	100 Mbps
Fieldbus interface, note on transmission rate	100 Mb, switched; Fast Ethernet
Fieldbus interface, type	Ethernet
Fieldbus interface, type of connection	2 x socket
Fieldbus interface, connection technology	M12x1, D-coded to EN 61076-2-101
Fieldbus interface, number of pins/cores	4
Fieldbus interface, galvanic isolation	Yes

Technical data – Communication interface, EtherNet/IP interface

Communication interface, protocol	AP
Communication interface, function	System communication XF20 OUT
Communication interface, connection type	Socket
Communication interface, connection technology	M8x1, D-coded to EN 61076-2-114
Communication interface, number of pins/wires	4
Communication interface, screened	Yes

Technical data – Mechanical, EtherNet/IP interface

Type of mounting	Screw-clamped
Product weight	113 g
Dimensions W x L x H	(incl. interlinking block); 50.1 mm x 107.3 mm x 57.5 mm
Grid dimension	50.1 mm

Materials – EtherNet/IP interface

Housing material	PC
Cover material	Reinforced PBT
Inspection window material	PC
O-ring material	FPM
Threaded sleeve material	High-alloy stainless steel
Screw material	Nickel-plated steel
Note on materials	RoHS-compliant; free of halogen; free of phosphoric acid ester
LABS (PWIS) conformity	VDMA24364-B2-L

Datasheet – EtherNet/IP interface

Operating and environmental conditions – EtherNet/IP interface

Ambient temperature	-20 ... 50 °C
Note on ambient temperature	Note ambient temperature derating according to IEC 61131-2:2017
Storage temperature	-20 ... 70 °C
Corrosion resistance class CRC ¹⁾	1 - Low corrosion stress
Relative humidity	5 - 95%, non-condensing
Nominal operating altitude	<= 2000 m ASL (> 79.5 kPa)
Max. setup altitude	3500 m
Note on max. setup altitude	> 2000 m ASL (< 79.5 kPa) Note ambient temperature derating according to IEC 61131-2:2017
Vibration resistance	Transport application test with severity level 2 to FN 942017-4 and EN 60068-2-6
Note on vibration resistance	SG1 on H-rail SG2 on direct mounting Transport application test with severity level 1 to FN 942017-4 and EN 60068-2-6
Shock resistance	Shock test with severity level 2 to FN 942017-5 and EN 60068-2-27
Note on shock resistance	30 g/11 ms to EN 60068-2-27 SG1 on H-rail SG2 on direct mounting Shock test with severity level 1 to FN 942017-5 and EN 60068-2-27
Material fire test	UL94 V-0 (housing)



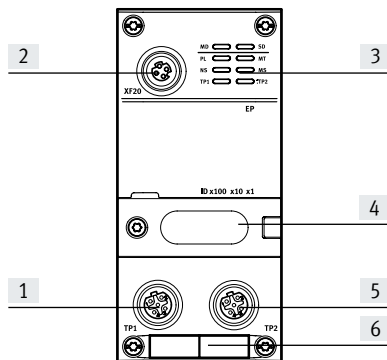

1) More information www.festo.com/x/topic/crc

Connection and display components

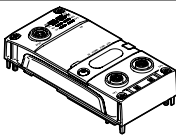

- [1] Network connection 1, EtherNet/IP
- [2] Communication interface
- [3] LED indicators
- [4] Rotary switch cover
- [5] Network connection 2, EtherNet/IP
- [6] Space for inscription label

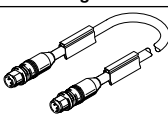
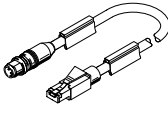
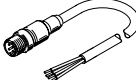
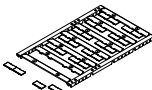
Datasheet – EtherNet/IP interface

Ordering data		Part no.	Type			
	EtherNet/IP interface	8129244	CPX-AP-A-EP-M12			
Ordering data – Accessories						
Description		Pack size	Part no.	Type		
Plug connectors for self-assembly						
	For bus connection	Straight plug, M12x1, 4-pin, D-coded	–	543109	NECU-M-S-D12G4-C2-ET	
Connecting cables						
	Straight plug, M12x1, 4-pin, D-coded	Straight plug, M12x1, 4-pin, D-coded	0.5 m	–	8040446	NEBC-D12G4-ES-0.5-S-D12G4-ET
			1 m	–	8040447	NEBC-D12G4-ES-1-S-D12G4-ET
			3 m	–	8040448	NEBC-D12G4-ES-3-S-D12G4-ET
			5 m	–	8040449	NEBC-D12G4-ES-5-S-D12G4-ET
			10 m	–	8040450	NEBC-D12G4-ES-10-S-D12G4-ET
	Straight plug, M12x1, 4-pin, D-coded	Straight plug, RJ45, 8-pin	1 m	–	8040451	NEBC-D12G4-ES-1-S-R3G4-ET
			3 m	–	8040452	NEBC-D12G4-ES-3-S-R3G4-ET
			5 m	–	8040453	NEBC-D12G4-ES-5-S-R3G4-ET
			10 m	–	8040454	NEBC-D12G4-ES-10-S-R3G4-ET
	Straight plug, M12x1, 4-pin, D-coded	Open end, 4-wire	5 m	–	8040456	NEBC-LE4-ES-5-D12G4-ET
Inscription labels						
	For modules CPX-AP-A	Size 6x 12.5 mm, 10 frames with 24 pieces each	240	8087174	ASLR-LX4-612-P240	
Cover cap						
	For sealing unused connections	For connection M8x1	10	177672	ISK-M8	
		For connection M12x1	10	165592	ISK-M12	

Datasheet – IO-Link master

Function

The IO-Link master has 4 IO-Link connections Class B (type B), which enable any IO-Link components to be linked up to the automation system CPX-AP-A.

- IO-Link master
- Connection M12x1, 5-pin
- Status and error indication via LED

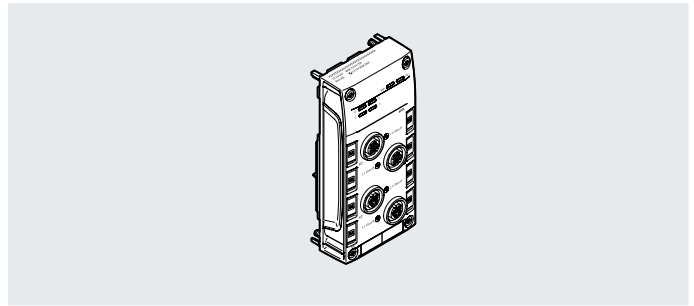

Description

The IO-Link communication system is used to exchange serial data from decentralised function modules (devices) at the field level.

The IO-Link master provides four external IO-Link interfaces, at each of which a device can be connected.

The connection type corresponds to a star topology, which means that only one device can be connected to each port.

The address space, master port and the connected devices can be parameterised with the help of the IO-Link device tool.

The address space, master port and connected devices can be parameterised with the aid of the Festo Automation Suite.

The Festo Automation Suite can be downloaded from the Festo website.

General technical data – IO-Link master

Protocol	IO-Link
Communication interface, protocol	AP
Max. address volume inputs	33 byte
Max. address volume for outputs	33 byte
Configuration support	IODD file
Module parameters	Configuration of voltage monitoring load supply PL
Channel parameter	Activation diagnostics for IO-Link device lost; port mode; target deviceID; target vendorID; target cycle time
Diagnostics via LED	Diagnostics per channel; diagnostics per module; power supply load; status per channel; status per module
Diagnostics via internal communication	IO-Link event; sensor supply shortcut/overload; overvoltage electronics/sensors; overvoltage load; undervoltage electronics/sensors; undervoltage load
Internal cycle time	< 1 ms
Reverse polarity protection	Yes
Max. cable length	20 m with IO-Link operation
Mounting position	Any

Technical data – IO-Link interface, IO-Link master

IO-Link, protocol version	Master V 1.1
IO-Link, communication mode	Configurable via software; SIO, COM1 (4.8 kBaud), COM2 (38.4 kBaud), COM3 (230.4 kBaud)
IO-Link, SIO mode support	Yes
IO-Link, port class	B
IO-Link, number of ports	4
IO-Link, process data width OUT	Can be parameterised 8 - 128 bytes
IO-Link, process data width IN	Can be parameterised 12 - 132 bytes
IO-Link, communication	C/Q LED green
IO-Link, minimum cycle time	Depending on minimally supported cycle time of connected IO-Link device
Electrical connection for IO-Link, connection type	4 x socket
Electrical connection for IO-Link, connection technology	M12x1, A-coded to EN 61076-2-101
Electrical connection for IO-Link, number of pins/wires	5

Datasheet – IO-Link master

Technical data – Electrical, IO-Link master

Nominal operating voltage DC for electronics/sensors	24 V
Nominal operating voltage DC load	24 V
Permissible voltage fluctuations, electronics/sensors	± 25%
Permissible voltage fluctuations, load	± 25%
Note on the operating voltage	SELV/PELV power supply units required; note voltage drop
Note on nominal operating voltage DC	Protected extra-low voltage to IEC 60204-1
Power failure buffering	10 ms
Intrinsic current consumption at nominal operating voltage, electronics/sensors	Typical 40 mA
Intrinsic current consumption at nominal operating voltage, load	Typical 4 mA
Max. power supply per channel	2.1 A (50 W lamp load), per channel pair
Max. total current of inputs per module	2
Max. residual current outputs per module	4
Potential separation between the supply voltages electronics/sensors and load/valves	Yes
Electrical isolation of outputs between channel - internal communication	Yes
Fuse protection inputs (short circuit)	Internal electronic fuse per module
Protection class	III
Overvoltage category	II
Pollution degree	2

Technical data – Mechanical, IO-Link master

Type of mounting	Screw-clamped
Product weight	90 g
Dimensions W x L x H	(incl. interlinking block); 50.1 mm × 107.3 mm × 57.5 mm
Grid dimension	50.1 mm

Materials – IO-Link master

Housing material	PC
Cover material	Reinforced PBT
O-ring material	FPM
Screw material	Nickel-plated steel
Note on materials	RoHS-compliant; free of halogen; free of phosphoric acid ester
LABS (PWIS) conformity	VDMA24364-B2-L

Datasheet – IO-Link master

Operating and environmental conditions – IO-Link master

Ambient temperature	-20 ... 50 °C
Note on ambient temperature	Note ambient temperature derating according to IEC 61131-2:2017
Storage temperature	-20 ... 70 °C
Corrosion resistance class CRC ¹⁾	1 - Low corrosion stress
Relative humidity	5 - 95%, non-condensing
Nominal operating altitude	<= 2000 m ASL (> 79.5 kPa)
Max. setup altitude	3500 m
Note on max. setup altitude	> 2000 m ASL (< 79.5 kPa) Note ambient temperature derating according to IEC 61131-2:2017
Vibration resistance	Transport application test with severity level 2 to FN 942017-4 and EN 60068-2-6
Note on vibration resistance	SG1 on H-rail SG2 on direct mounting Transport application test with severity level 1 to FN 942017-4 and EN 60068-2-6
Shock resistance	Shock test with severity level 2 to FN 942017-5 and EN 60068-2-27
Note on shock resistance	30 g/11 ms to EN 60068-2-27 SG1 on H-rail SG2 on direct mounting Shock test with severity level 1 to FN 942017-5 and EN 60068-2-27
Material fire test	UL94 V-0 (housing)

1) More information www.festo.com/x/topic/crc

Connection and display components

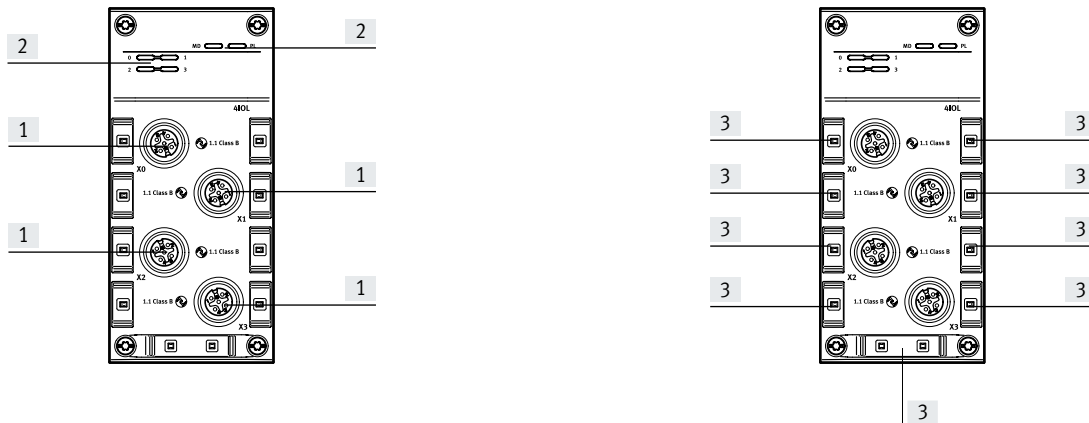





[1] IO-Link connection

[2] LED indicators

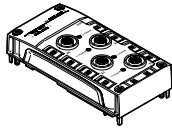
[3] Space for inscription label

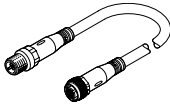
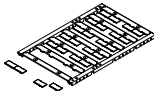
Datasheet – IO-Link master

Ordering data						
	Protocol	IO-Link, number of ports	Part no.	Type		
	IO-Link	4	8129114	CPX-AP-A-4IOL-M12		
Ordering data – Accessories						
	Description		Pack size	Part no.	Type	
Plug connectors for self-assembly						
	For IO-Link	Straight plug, M12x1, 3-pin, A-coded	Insulation displacement connector	–	562027	NECU-S-M12G3-HX
		Straight plug, M12x1, 4-pin, A-coded	Insulation displacement connector	–	562028	NECU-S-M12G4-HX
		Straight plug, M12x1, 5-pin, A-coded	Screw terminal	–	175487	SEA-M12-5GS-PG7
Connecting cables						
	Plug, 5-pin, M12	Socket, 5-pin, M12	0.5 m	–	8000208	NEBU-M12G5-K-0.5-M12G4
			1 m	–	574321	NEBU-M12G5-E-5-Q8N-M12G5
			7.5 m	–	574322	NEBU-M12G5-E-7.5-Q8N-M12G5
	Modular system for a choice of connecting cables			–	–	NEBU-... → Internet: nebu
Inscription labels						
	For modules CPX-AP-A	Size 6x 12.5 mm, 10 frames with 24 pieces each	240	8087174	ASLR-L-X4-612-P240	
Cover cap						
	For sealing unused connections	For connection M12x1	10	165592	ISK-M12	

Datasheet – Digital input modules

Function

Digital input modules facilitate the connection of electric sensors to IEC 61131-2 type 3 (inductive, capacitive) with an operating voltage of 24 V DC.

- Input modules for 24 V DC operating voltage
- Connection M12x1, 5-pin
- Status and error indication via LED
- Electronic fuse per channel

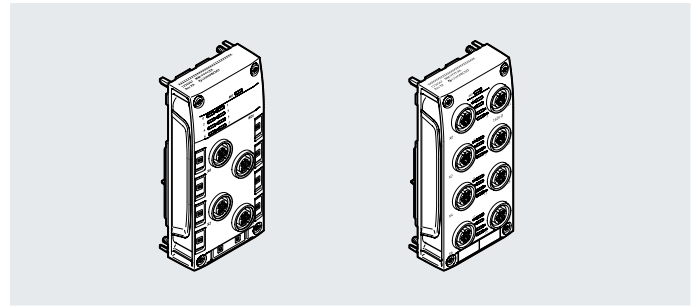

General technical data – Input modules

Electrical connection, input, connection type	4 x socket	8 x socket
Communication interface, protocol	AP	
Number of inputs	8	16
Max. address volume inputs	1 byte	2 byte
Channel parameter	Input debounce time	
Diagnostics via LED	Diagnostics per module; status per channel	Diagnostics per channel; status per channel
Diagnostics via internal communication	Communication errors; sensor supply shortcut/overload; overvoltage electronics/sensors; overvoltage load; undervoltage electronics/sensors	
Reverse polarity protection	Yes	
Max. cable length	30 m inputs	
Mounting position	Any	

Technical data – Interfaces, input modules

Electrical connection, input, connection type	4 x socket	8 x socket
Electrical connection, input, function	Digital input	
Electrical connection, input, connection technology	M12x1, A-coded to EN 61076-2-101	
Electrical connection, input, number of pins/wires	5	
Switching logic at inputs	PNP (positive switching) 2-wire sensors to IEC 61131-2 3-wire sensors to IEC 61131-2	
Input characteristics	To IEC 61131-2, type 3	
Switching level	Signal 0: ≤ 5 V Signal 1: ≥ 11 V	
Fuse protection inputs (short circuit)	Internal electronic fuse per module	Internal electronic fuse per socket
Input debounce time	0.1 ms; 3 ms (standard); 10 ms; 20 ms	

Datasheet – Digital input modules

Technical data – Electrical, input modules

Electrical connection, input, connection type	4 x socket	8 x socket
Nominal operating voltage DC for electronics/sensors	24 V	
Permissible voltage fluctuations, electronics/sensors	± 25%	
Note on the operating voltage	SELV/PELV power supply units required; note voltage drop	
Note on nominal operating voltage DC	Protected extra-low voltage to IEC 60204-1	
Power failure buffering	10 ms	
Intrinsic current consumption at nominal operating voltage, electronics/sensors	Typical 40 mA	
Max. total current of inputs per module	1.8 A	4 A
Electrical isolation of inputs between channels	No	
Electrical isolation of inputs between channel - internal communication	Yes	
Protection class	III	
Overvoltage category	II	
Pollution degree	2	

Technical data – Mechanical, input modules

Electrical connection, input, connection type	4 x socket	8 x socket
Type of mounting	Screw-clamped	
Product weight	87 g	96 g
Dimensions W x L x H	(incl. interlinking block); 50.1 mm × 107.3 mm × 57.5 mm	
Grid dimension	50.1 mm	

Materials – Input modules

Housing material	PC	
Cover material	Reinforced PBT	
O-ring material	FPM	
Screw material	Nickel-plated steel	
Note on materials	RoHS-compliant; free of halogen; free of phosphoric acid ester	
LABS (PWIS) conformity	VDMA24364-B2-L	

Operating and environmental conditions – Input modules

Ambient temperature	-20 ... 50 °C	
Note on ambient temperature	Note ambient temperature derating according to IEC 61131-2:2017	
Storage temperature	-20 ... 70 °C	
Corrosion resistance class CRC ¹⁾	1 - Low corrosion stress	
Relative humidity	5 - 95%, non-condensing	
Nominal operating altitude	≤ 2000 m ASL (> 79.5 kPa)	
Max. setup altitude	3500 m	
Note on max. setup altitude	> 2000 m ASL (< 79.5 kPa) Note ambient temperature derating according to IEC 61131-2:2017	
Vibration resistance	Transport application test with severity level 2 to FN 942017-4 and EN 60068-2-6	
Note on vibration resistance	SG1 on H-rail SG2 on direct mounting Transport application test with severity level 1 to FN 942017-4 and EN 60068-2-6	
Shock resistance	Shock test with severity level 2 to FN 942017-5 and EN 60068-2-27	
Note on shock resistance	30 g/11 ms to EN 60068-2-27 SG1 on H-rail SG2 on direct mounting Shock test with severity level 1 to FN 942017-5 and EN 60068-2-27	
Material fire test	UL94 V-0 (housing)	

1) More information www.festo.com/x/topic/crc

Datasheet – Digital input modules

Connection and display components – Module with 8 inputs

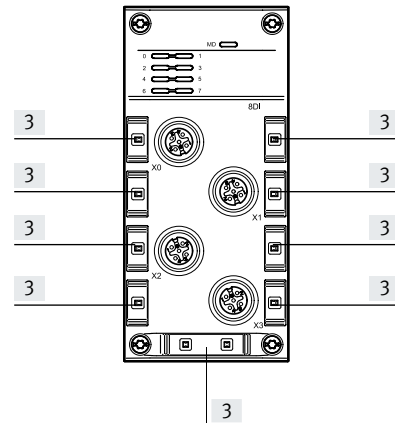
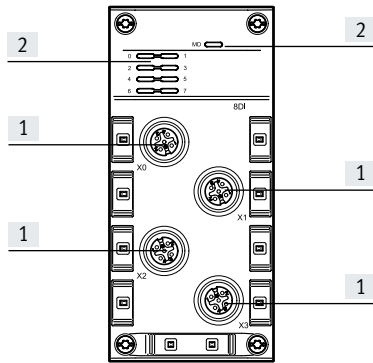

[1] Electrical connection, inputs

[2] LED indicators

[3] Space for inscription label

Connection and display components – Module with 16 inputs

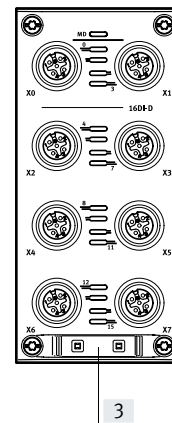
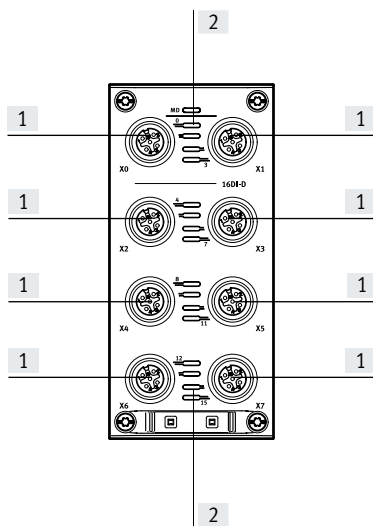

[1] Electrical connection, inputs

[2] LED indicators





[3] Space for inscription label

Pin allocation for sensor connections

Terminal allocation	Pin	Allocation	Description
	1	24 V	Operating voltage 24 V
	2	Ix+1*	Input signal
	3	0 V	Operating voltage 0 V
	4	Ix*	Input signal
	5	FE	Functional earth

* Ix = Input x

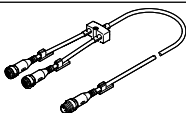
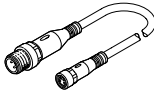
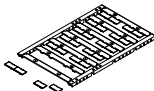
Datasheet – Digital input modules

Ordering data		Number of inputs	Part no.	Type		
	Digital input module	8	8129109	CPX-AP-A-8DI-M12-5P		
		16	8129112	CPX-AP-A-16DI-D-M12-5P		
Ordering data – Accessories						
Description		Pack size	Part no.	Type		
Plug connectors for self-assembly						
	Screw terminal	Straight plug, M12x1, 5-pin, A-coded	Cable fitting Pg7	–	175487	SEA-M12-5GS-PG7
			Cable fitting Pg11	–	192010	SEA-5GS-11-DUO
	Insulation displacement connector	Straight plug, M12x1, 4-pin, A-coded	–	–	562028	NECU-S-M12G4-HX
Distributor						
	Straight plug, M12x1, 4-pin, A-coded	2x socket, M8 A-coded, 3-pin	–	–	8005311	NEDY-L2R1-V1-M8G3-N-M12G4
		2x socket, M12 A-coded, 5-pin	–	–	8005310	NEDY-L2R1-V1-M12G5-N-M12G4
	Straight plug, M12x1, 4-pin, A-coded	2x socket, M8 A-coded, 3-pin	2.5 m	–	8005301	NEDY-L2R1-V1-M8G3-U-M12G4-2.5R
			5 m	–	8005302	NEDY-L2R1-V1-M8G3-U-M12G4-5R
			0.3 m + 2.5 m	–	8032309	NEDY-L2R1-V1-M8G3-U-0.3L-M12G4-2.5R
		2x socket, M12 A-coded, 5-pin	0.3 m + 5 m	–	8035484	NEDY-L2R1-V1-M8G3-U-0.3L-M12G4-5R
			2.5 m	–	8005305	NEDY-L2R1-V1-M12G5-U-M12G4-2.5R
			5 m	–	8005306	NEDY-L2R1-V1-M12G5-U-M12G4-5R
		0.3 m + 2.5 m	–	8035775	NEDY-L2R1-V1-M12G5-U-0.3L-M12G4-2.5R	
		0.3 m + 5 m	–	8035776	NEDY-L2R1-V1-M12G5-U-0.3L-M12G4-5R	
	Modular system for all types of sensor/actuator distributor		–	–	–	NEDY-... → Internet: nedy
Connecting cables						
	Plug, 4-pin, M12	Socket, 5-pin, M12	0.5 m	–	8000208	NEBU-M12G5-K-0.5-M12G4
		Socket, 4-pin, M8	1 m	–	8091513	NEBU-M8G4-K-1-N-M12G4
	Modular system for a choice of connecting cables		–	–	–	NEBU-... → Internet: nebu
Inscription labels						
	For modules CPX-AP-A	Size 6x 12.5 mm, 10 frames with 24 pieces each	240		8087174	ASLR-L-X4-612-P240
Cover cap						
	For sealing unused connections	For connection M12x1	10		165592	ISK-M12

Datasheet – Digital output modules

Function

Digital output modules make it possible to connect electrical consumers in accordance with IEC 61131-2 type 0.5 (valves, contactors or display components) with an operating voltage of 24 V DC.

- Output modules for 24 V DC operating voltage
- Connection M12x1, 5-pin
- Status and error indication via LED
- Electronic fuse protection against short circuit or overload with automatic resetting
- Slow response; possible short-term increase in current requirement

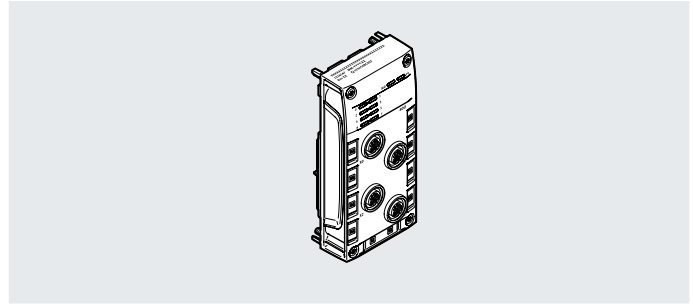

General technical data – Output modules

Communication interface, protocol	AP
Number of outputs	8
Max. address volume for outputs	1 byte
Module parameters	Configuration of voltage monitoring of load supply PL; behaviour after short circuit/overload at output
Diagnostics via LED	Diagnostics per channel; diagnostics per module; power supply load; status per channel
Diagnostics via internal communication	Switch-off load supply; communication error; short circuit/overload output signal; overvoltage electronics/sensors; overvoltage load; undervoltage electronics/sensors; undervoltage load
Reverse polarity protection	Yes
Max. cable length	30 m outputs
Mounting position	Any

Technical data – Interfaces, output modules

Electrical connection, output, function	Digital output
Electrical connection, output, connection type	4 x socket
Electrical connection, output, connection technology	M12x1, A-coded to EN 61076-2-101
Electrical connection, output, number of pins/wires	5
Switching logic at outputs	PNP (positive switching)
Characteristic curve of outputs	To IEC 61131-2, type 0.5
Output delay with resistive load	Signal change 0->1: < 200 µs Signal change 1->0: < 200 µs

Datasheet – Digital output modules

Technical data – Electrical, output modules

Nominal operating voltage DC for electronics/sensors	24 V
Permissible voltage fluctuations, electronics/sensors	± 25%
Note on the operating voltage	SELV/PELV power supply units required; note voltage drop
Note on nominal operating voltage DC	Protected extra-low voltage to IEC 60204-1
Power failure buffering	10 ms
Intrinsic current consumption at nominal operating voltage, electronics/sensors	Typical 40 mA
Intrinsic current consumption at nominal operating voltage, load	Typical 5 mA
Max. power supply per channel	0.5 A
Max. residual current outputs per module	4 A
Potential separation between the supply voltages electronics/sensors and load/valves	Yes
Electrical isolation of outputs between channels	No
Electrical isolation of outputs between channel - internal communication	Yes
Fuse protection for outputs	–
Protection class	III
Overvoltage category	II
Pollution degree	2

Technical data – Mechanical, output modules

Type of mounting	Screw-clamped
Product weight	91 g
Dimensions W x L x H	(incl. interlinking block); 50.1 mm × 107.3 mm × 57.5 mm
Grid dimension	50.1 mm

Materials – Output modules

Housing material	PC
Cover material	Reinforced PBT
O-ring material	FPM
Screw material	Nickel-plated steel
Note on materials	RoHS-compliant; free of halogen; free of phosphoric acid ester
LABS (PWIS) conformity	VDMA24364-B2-L

Datasheet – Digital output modules

Operating and environmental conditions – Output modules

Ambient temperature	-20 ... 50 °C
Note on ambient temperature	Note ambient temperature derating according to IEC 61131-2:2017
Storage temperature	-20 ... 70 °C
Corrosion resistance class CRC ¹⁾	1 - Low corrosion stress
Relative humidity	5 - 95%, non-condensing
Nominal operating altitude	<= 2000 m ASL (> 79.5 kPa)
Max. setup altitude	3500 m
Note on max. setup altitude	> 2000 m ASL (< 79.5 kPa) Note ambient temperature derating according to IEC 61131-2:2017
Vibration resistance	Transport application test with severity level 2 to FN 942017-4 and EN 60068-2-6
Note on vibration resistance	SG1 on H-rail SG2 on direct mounting Transport application test with severity level 1 to FN 942017-4 and EN 60068-2-6
Shock resistance	Shock test with severity level 2 to FN 942017-5 and EN 60068-2-27
Note on shock resistance	30 g/11 ms to EN 60068-2-27 SG1 on H-rail SG2 on direct mounting Shock test with severity level 1 to FN 942017-5 and EN 60068-2-27
Material fire test	UL94 V-0 (housing)

1) More information www.festo.com/x/topic/crc

Connection and display components

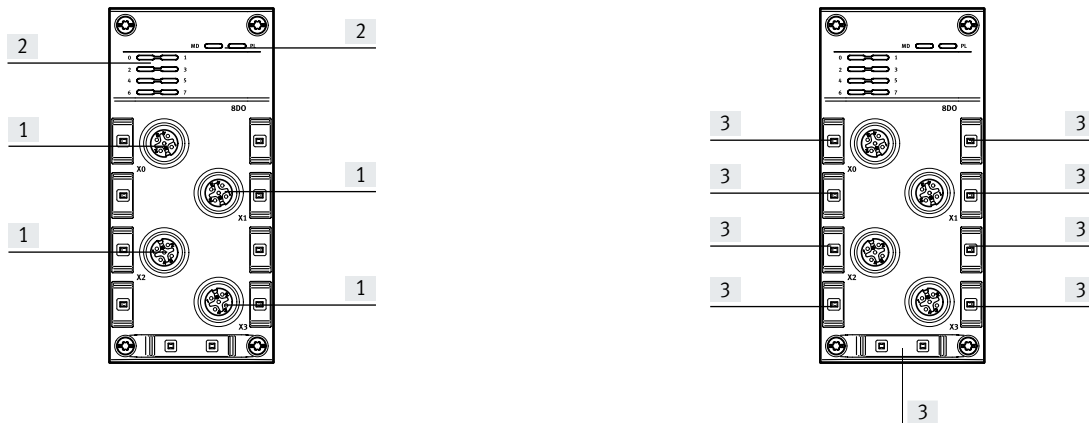

[1] Electrical connection, outputs

[2] LED indicators

[3] Space for inscription label



Pin allocation for outputs

Terminal allocation	Pin	Allocation	Description
	1	n.c.	Not connected
	2	Ox+1*	Output signal
	3	0 V	Operating voltage 0 V
	4	Ox*	Output signal
	5	FE	Functional earth



* Ox = Output x

Datasheet – Digital output modules

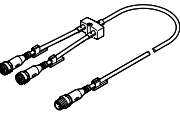
Ordering data		Number of outputs	Part no.	Type
	Digital output module	8	8129110	CPX-AP-A-8DO-M12-5P

Ordering data – Accessories						
Description		Pack size	Part no.	Type		
Plug connectors for self-assembly						
	Screw terminal	Straight plug, M12x1, 5-pin, A-coded	Cable fitting Pg7	–	175487	SEA-M12-5GS-PG7
			Cable fitting Pg11	–	192010	SEA-5GS-11-DUO
	Insulation displacement connector	Straight plug, M12x1, 4-pin, A-coded	–	–	562028	NECU-S-M12G4-HX
Distributor						
	Straight plug, M12x1, 4-pin, A-coded	2x socket, M8 A-coded, 3-pin	–	–	8005311	NEDY-L2R1-V1-M8G3-N-M12G4
		2x socket, M12 A-coded, 5-pin	–	–	8005310	NEDY-L2R1-V1-M12G5-N-M12G4
	Straight plug, M12x1, 4-pin, A-coded	2x socket, M8 A-coded, 3-pin	2.5 m	–	8005301	NEDY-L2R1-V1-M8G3-U-M12G4-2.5R
			5 m	–	8005302	NEDY-L2R1-V1-M8G3-U-M12G4-5R
			0.3 m + 2.5 m	–	8032309	NEDY-L2R1-V1-M8G3-U-0.3L-M12G4-2.5R
			0.3 m + 5 m	–	8035484	NEDY-L2R1-V1-M8G3-U-0.3L-M12G4-5R
		2x socket, M12 A-coded, 5-pin	2.5 m	–	8005305	NEDY-L2R1-V1-M12G5-U-M12G4-2.5R
			5 m	–	8005306	NEDY-L2R1-V1-M12G5-U-M12G4-5R
			0.3 m + 2.5 m	–	8035775	NEDY-L2R1-V1-M12G5-U-0.3L-M12G4-2.5R
			0.3 m + 5 m	–	8035776	NEDY-L2R1-V1-M12G5-U-0.3L-M12G4-5R
		2x socket, plug pattern type A to EN 175301-803	0.3 m + 2.5 m	–	8035791	NEDY-L2R1-V1-A1W4L-U-0.3L-M12G4-2.5R
			0.3 m + 5 m	–	8035792	NEDY-L2R1-V1-A1W4L-U-0.3L-M12G4-5R
		2x socket, plug pattern type B to industry standard, 11 mm	0.3 m + 2.5 m	–	8035779	NEDY-L2R1-V1-B2W3L-U-0.3L-M12G4-2.5R
			0.3 m + 5 m	–	8035780	NEDY-L2R1-V1-B2W3L-U-0.3L-M12G4-5R
		2x socket, plug pattern type C to EN 175301-803	0.3 m + 2.5 m	–	8035783	NEDY-L2R1-V1-C1W4L-U-0.3L-M12G4-2.5R
			0.3 m + 5 m	–	8035784	NEDY-L2R1-V1-C1W4L-U-0.3L-M12G4-5R
2x socket, plug pattern ZC, metric screw	0.3 m + 2.5 m	–	8035787	NEDY-L2R1-V1-Z4W2Z-U-0.3L-M12G4-2.5R		
	0.3 m + 5 m	–	8035788	NEDY-L2R1-V1-Z4W2Z-U-0.3L-M12G4-5R		
Modular system for all types of sensor/actuator distributor		–	–	–	NEDY-...	→ Internet: nedy

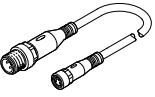
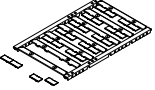
Datasheet – Digital output modules

Ordering data – Accessories						
	Description			Pack size	Part no.	Type
Connecting cables						
	Plug, 4-pin, M12	Socket, 5-pin, M12	0.5 m	–	8000208	NEBU-M12G5-K-0.5-M12G4
		Socket, 4-pin, M8	1 m	–	8091513	NEBU-M8G4-K-1-N-M12G4
	Modular system for a choice of connecting cables			–	–	NEBU-... → Internet: nebu
Inscription labels						
	For modules CPX-AP-A	Size 6x 12.5 mm, 10 frames with 24 pieces each		240	8087174	ASLR-L-X4-612-P240
Cover cap						
	For sealing unused connections		For connection M12x1	10	165592	ISK-M12

Datasheet – Digital input/output modules

Function

Digital input/output modules facilitate the connection of electric sensors to IEC 61131-2 type 3 (inductive, capacitive) and of electrical consumers to IEC 61131-2 type 0.5 with an operating voltage of 24 V DC.

- Input/output modules for 24 V DC operating voltage
- Connection M12x1, 5-pin
- Status and error indication via LED
- Electronic fuse protection against short circuit or overload with automatic resetting
- Slow response; possible short-term increase in current requirement

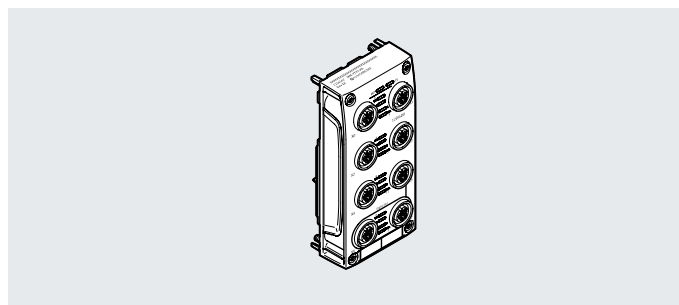

General technical data – Input/output modules

Communication interface, protocol	AP
Number of inputs	12
Number of outputs	4
Max. address volume inputs	2 byte
Max. address volume for outputs	1 byte
Module parameters	Configuration of voltage monitoring of load supply PL; behaviour after short circuit/overload, analogue output
Channel parameter	Input debounce time
Diagnostics via LED	(Outputs) Diagnostics per channel; (outputs) power supply load; (inputs-outputs) diagnostics per module; (inputs-outputs) status per channel
Diagnostics via internal communication	Switch-off load supply; communication error; short circuit/overload output signal; sensor supply, short circuit/overload; overvoltage electronics/sensors; overvoltage load; undervoltage electronics/sensors; undervoltage load
Reverse polarity protection	Yes
Max. cable length	30 m outputs; 30 m inputs
Mounting position	Any

Technical data – Interfaces, input/output modules

Electrical connection, input, function	Digital input
Electrical connection, input, connection type	6 x socket
Electrical connection, input, connection technology	M12x1, A-coded to EN 61076-2-101
Electrical connection, input, number of pins/wires	5
Electrical connection, output, function	Digital output
Electrical connection, output, connection type	2 x socket
Electrical connection, output, connection technology	M12x1, A-coded to EN 61076-2-101
Electrical connection, output, number of pins/wires	5
Switching logic at inputs	PNP (positive switching) 2-wire sensors to IEC 61131-2 3-wire sensors to IEC 61131-2
Switching logic at outputs	PNP (positive switching)
Input characteristics	To IEC 61131-2, type 3
Characteristic curve of outputs	To IEC 61131-2, type 0.5
Switching level	Signal 0: ≤ 5 V Signal 1: ≥ 11 V
Fuse protection inputs (short circuit)	Internal electronic fuse per module
Fuse protection outputs (short circuit)	Internal electronic fuse per channel
Input debounce time	0.1 ms; 3 ms (standard); 10 ms; 20 ms
Output delay with resistive load	Signal change 0->1: < 200 μ s Signal change 1->0: < 200 μ s

Datasheet – Digital input/output modules

Technical data – Electrical, input/output modules

Nominal operating voltage DC for electronics/sensors	24 V
Nominal operating voltage DC load	24 V
Permissible voltage fluctuations, electronics/sensors	± 25%
Permissible voltage fluctuations, load	± 25%
Note on the operating voltage	SELV/PELV power supply units required; note voltage drop
Note on nominal operating voltage DC	Protected extra-low voltage to IEC 60204-1
Power failure buffering	10 ms
Intrinsic current consumption at nominal operating voltage, electronics/sensors	Typical 40 mA
Intrinsic current consumption at nominal operating voltage, load	Typical 5 mA
Max. power supply per channel	0.5 A
Max. total current of inputs per module	1.8 A
Max. residual current outputs per module	2 A
Potential separation between the supply voltages electronics/sensors and load/valves	Yes
Electrical isolation of inputs between channels	No
Electrical isolation of inputs between channel - internal communication	Yes
Electrical isolation of outputs between channels	No
Electrical isolation of outputs between channel - internal communication	Yes
Protection class	III
Overvoltage category	II
Pollution degree	2

Technical data – Mechanical, input/output modules

Type of mounting	Screw-clamped
Product weight	98 g
Dimensions W x L x H	(incl. interlinking block); 50.1 mm × 107.3 mm × 57.5 mm
Grid dimension	50.1 mm

Materials – Input/output modules

Housing material	PC
Cover material	Reinforced PBT
O-ring material	FPM
Screw material	Nickel-plated steel
Note on materials	RoHS-compliant; free of halogen; free of phosphoric acid ester
LABS (PWIS) conformity	VDMA24364-B2-L

Datasheet – Digital input/output modules

Operating and environmental conditions – Input/output modules

Ambient temperature	-20 ... 50 °C
Note on ambient temperature	Note ambient temperature derating according to IEC 61131-2:2017
Storage temperature	-20 ... 70 °C
Corrosion resistance class CRC ¹⁾	1 - Low corrosion stress
Relative humidity	5 - 95%, non-condensing
Nominal operating altitude	<= 2000 m ASL (> 79.5 kPa)
Max. setup altitude	3500 m
Note on max. setup altitude	> 2000 m ASL (< 79.5 kPa) Note ambient temperature derating according to IEC 61131-2:2017
Vibration resistance	Transport application test with severity level 2 to FN 942017-4 and EN 60068-2-6
Note on vibration resistance	SG1 on H-rail SG2 on direct mounting Transport application test with severity level 1 to FN 942017-4 and EN 60068-2-6
Shock resistance	Shock test with severity level 2 to FN 942017-5 and EN 60068-2-27
Note on shock resistance	30 g/11 ms to EN 60068-2-27 SG1 on H-rail SG2 on direct mounting Shock test with severity level 1 to FN 942017-5 and EN 60068-2-27
Material fire test	UL94 V-0 (housing)

1) More information www.festo.com/x/topic/crc

Connection and display components

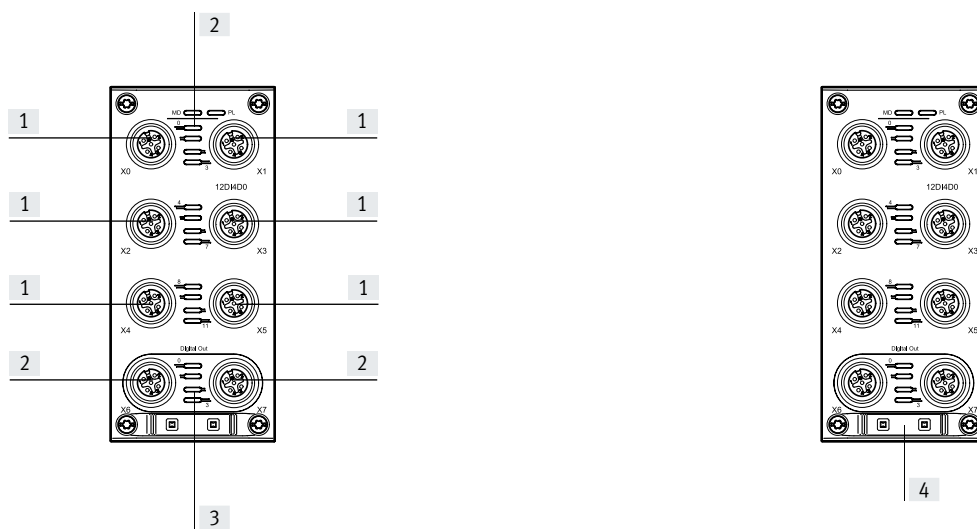

[1] Electrical connection, inputs

[2] Electrical connection, outputs

[4] Space for inscription label

[3] LED indicators

Datasheet – Digital input/output modules

Pin allocation for inputs

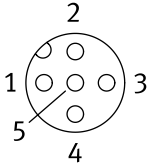
Terminal allocation	Pin	Allocation	Description
	1	24 V	Operating voltage 24 V
	2	Ix+1*	Input signal
	3	0 V	Operating voltage 0 V
	4	Ix*	Input signal
	5	FE	Functional earth



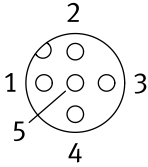

* Ix = Input x

Pin allocation for outputs

Terminal allocation	Pin	Allocation	Description
	1	n.c.	Not connected
	2	Ox+1*	Output signal
	3	0 V	Operating voltage 0 V
	4	Ox*	Output signal
	5	FE	Functional earth

* Ox = Output x

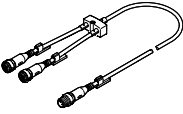
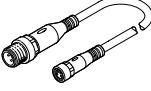
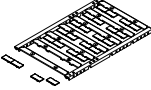
Datasheet – Digital input/output modules

Ordering data						
		Number of outputs	Number of inputs	Part no.	Type	
	Digital input/output module	4	12	8129111	CPX-AP-A-12DI4DO-M12-5P	
Ordering data – Accessories						
	Description		Pack size	Part no.	Type	
Plug connectors for self-assembly						
	Screw terminal	Straight plug, M12x1, 5-pin, A-coded	Cable fitting Pg7	–	175487	SEA-M12-5GS-PG7
			Cable fitting Pg11	–	192010	SEA-5GS-11-DUO
	Insulation displacement connector	Straight plug, M12x1, 4-pin, A-coded	–	–	562028	NECU-S-M12G4-HX
Distributor						
	Straight plug, M12x1, 4-pin, A-coded	2x socket, M8 A-coded, 3-pin	–	–	8005311	NEDY-L2R1-V1-M8G3-N-M12G4
		2x socket, M12 A-coded, 5-pin	–	–	8005310	NEDY-L2R1-V1-M12G5-N-M12G4
	Straight plug, M12x1, 4-pin, A-coded	2x socket, M8 A-coded, 3-pin	2.5 m	–	8005301	NEDY-L2R1-V1-M8G3-U-M12G4-2.5R
			5 m	–	8005302	NEDY-L2R1-V1-M8G3-U-M12G4-5R
			0.3 m + 2.5 m	–	8032309	NEDY-L2R1-V1-M8G3-U-0.3L-M12G4-2.5R
			0.3 m + 5 m	–	8035484	NEDY-L2R1-V1-M8G3-U-0.3L-M12G4-5R
		2x socket, M12 A-coded, 5-pin	2.5 m	–	8005305	NEDY-L2R1-V1-M12G5-U-M12G4-2.5R
			5 m	–	8005306	NEDY-L2R1-V1-M12G5-U-M12G4-5R
			0.3 m + 2.5 m	–	8035775	NEDY-L2R1-V1-M12G5-U-0.3L-M12G4-2.5R
			0.3 m + 5 m	–	8035776	NEDY-L2R1-V1-M12G5-U-0.3L-M12G4-5R
		2x socket, plug pattern type A to EN 175301-803	0.3 m + 2.5 m	–	8035791	NEDY-L2R1-V1-A1W4L-U-0.3L-M12G4-2.5R
			0.3 m + 5 m	–	8035792	NEDY-L2R1-V1-A1W4L-U-0.3L-M12G4-5R
		2x socket, plug pattern type B to industry standard, 11 mm	0.3 m + 2.5 m	–	8035779	NEDY-L2R1-V1-B2W3L-U-0.3L-M12G4-2.5R
			0.3 m + 5 m	–	8035780	NEDY-L2R1-V1-B2W3L-U-0.3L-M12G4-5R
		2x socket, plug pattern type C to EN 175301-803	0.3 m + 2.5 m	–	8035783	NEDY-L2R1-V1-C1W4L-U-0.3L-M12G4-2.5R
			0.3 m + 5 m	–	8035784	NEDY-L2R1-V1-C1W4L-U-0.3L-M12G4-5R
2x socket, plug pattern ZC, metric screw	0.3 m + 2.5 m	–	8035787	NEDY-L2R1-V1-Z4W2Z-U-0.3L-M12G4-2.5R		
	0.3 m + 5 m	–	8035788	NEDY-L2R1-V1-Z4W2Z-U-0.3L-M12G4-5R		
	Modular system for all types of sensor/actuator distributor	–	–	–	NEDY-...	→ Internet: nedy
Connecting cables						
	Plug, 4-pin, M12	Socket, 5-pin, M12	0.5 m	–	8000208	NEBU-M12G5-K-0.5-M12G4
		Socket, 4-pin, M8	1 m	–	8091513	NEBU-M8G4-K-1-N-M12G4
		Modular system for a choice of connecting cables	–	–	–	NEBU-...
Inscription labels						
	For modules CPX-AP-A	Size 6x 12.5 mm, 10 frames with 24 pieces each	240		8087174	ASLR-L-X4-612-P240
Cover cap						
	For sealing unused connections	For connection M12x1	10		165592	ISK-M12

Datasheet – End plates

Function

The end plates form the lateral end of the automation system CPX-AP-A and provide mounting holes for mounting on wall, H-rail or support system.

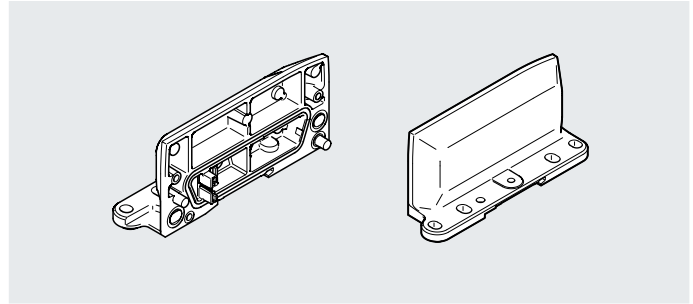

General technical data – End plates

Mounting position	Any, on H-rail: horizontal
-------------------	----------------------------

Technical data – Electrical, end plates

Protection class	III
Overvoltage category	II

Technical data – Mechanical, end plates

	Left-hand end plate	Right-hand end plate
Type of mounting	Direct mounting via through-hole; on H-rail with accessories; on mounting frame; with through-hole for screw M5; with through-hole for screw M6	
Product weight	120 g	116 g
Dimensions W x L x H	(Installation dimensions); 30.4 mm x 117.2 mm x 53.6 mm	
Grid dimension	50.1 mm	

Materials – End plates

	Left-hand end plate	Right-hand end plate
End plate material	Coated die-cast aluminium	Coated die-cast aluminium
Sealing material	–	Polyurethane foam
Screw material	Nickel-plated steel; galvanised steel	Nickel-plated steel
Note on materials	RoHS-compliant; free of halogen; free of phosphoric acid ester	RoHS-compliant; free of halogen; free of phosphoric acid ester
LABS (PWIS) conformity	VDMA24364-B2-L	VDMA24364-B2-L

Operating and environmental conditions – End plates

Ambient temperature	-20 ... 50 °C
Note on ambient temperature	Note ambient temperature derating according to IEC 61131-2:2017
Storage temperature	-20 ... 70 °C
Corrosion resistance class CRC ¹⁾	1 - Low corrosion stress
Relative humidity	5 - 95%, non-condensing
Nominal operating altitude	<= 2000 m ASL (> 79.5 kPa)
Max. setup altitude	3500 m
Note on max. setup altitude	> 2000 m ASL (< 79.5 kPa) Note ambient temperature derating according to IEC 61131-2:2017
Vibration resistance	Transport application test with severity level 2 to FN 942017-4 and EN 60068-2-6
Note on vibration resistance	SG1 on H-rail SG2 on direct mounting Transport application test with severity level 1 to FN 942017-4 and EN 60068-2-6
Shock resistance	Shock test with severity level 2 to FN 942017-5 and EN 60068-2-27
Note on shock resistance	30 g/11 ms to EN 60068-2-27 SG1 on H-rail SG2 on direct mounting Shock test with severity level 1 to FN 942017-5 and EN 60068-2-27

1) More information www.festo.com/x/topic/crc

Datasheet – End plates

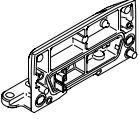
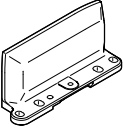
Ordering data		Part no.	Type
	Left-hand end plate	8112476	CPX-AP-A-EPL
	Right-hand end plate	8112477	CPX-AP-A-EPR

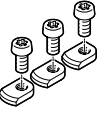
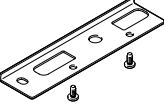
Ordering data – Accessories				
	Description	Pack size	Part no.	Type
Mounting				
	For H-rail mounting	–	8159824	CAFM-X5-H
	For mounting on support system with valve terminal VTSA/VTSA-F/VTSA-F-CB	–	8130845	CAFM-X5-K

Datasheet – Interlinking block with system supply

Function

Interlinking blocks ensure the electrical supply of all other CPX-AP-A modules. They have contact rails, from which the other CPX components on the interlinking modules are supplied with power.

The internal division of the power supply makes it possible to switch off specific areas of the sensors and actuators individually.

Area of application

- 24 V DC supply voltage for the electronics of the automation system CPX-AP-A
- 24 V DC supply voltage for inputs
- 24 V DC supply voltage for valves
- 24 V DC supply voltage for outputs

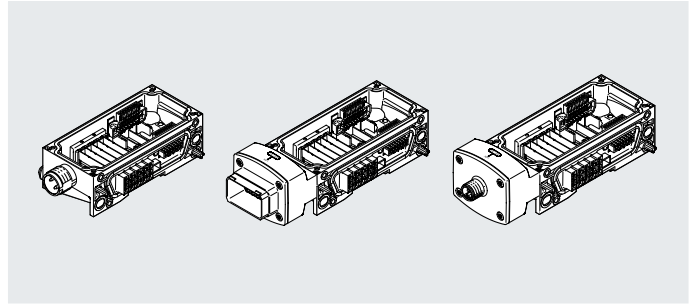

General technical data – System supply for interlinking blocks

Mounting position	Any, on H-rail: horizontal
-------------------	----------------------------

Technical data – Interfaces, system supply for interlinking blocks

Power supply, connection technology	7/8" to NFPA/T3.5.29	M12x1, L-coded to EN 61076-2-111	M18x1	Push-pull to IEC 61076-3-126
Power supply, function	Incoming electronics/sensors and load and functional earth			
Power supply, connection type	Plug			
Power supply, number of pins/wires	5		4	5
Power supply, conductor cross section	1.5 mm ²	2.5 mm ²		
Power transmission, function	–	Incoming electronics/sensors and load and functional earth	–	
Power transmission, connection type	–	Socket	–	
Power transmission, number of pins/wires	–	5	–	

General technical data – Electrical, system supply for interlinking blocks

Power supply, connection technology	7/8" to NFPA/T3.5.29	M12x1, L-coded to EN 61076-2-111	M18x1	Push-pull to IEC 61076-3-126
Nominal operating voltage DC for electronics/sensors	24 V			
Nominal operating voltage DC load	24 V			
Note on the operating voltage	SELV/PELV power supply units required; note voltage drop			
Note on nominal operating voltage DC	2x24 V [XD1,PS,PL], protected extra-low voltage to IEC 60204-1			
Nominal current	8 A	10 A, 16 A	8 A	10 A
Max. power supply	2 x 8 A (external fuse required)	2 x 10 A (external fuse required), 2 x 16 A (external fuse required)	2 x 8 A (external fuse required)	2 x 10 A (external fuse required)
Potential separation between the supply voltages electronics/sensors and load/valves	Yes		No	Yes
Protection class	III			
Overvoltage category	II			

Datasheet – Interlinking block with system supply

General technical data – Mechanical, system supply for interlinking blocks

Power supply, connection technology	7/8" to NFPA/T3.5.29	M12x1, L-coded to EN 61076-2-111	M18x1	Push-pull to IEC 61076-3-126
Type of mounting	On H-rail with accessories; with through-hole for M5 screw with accessories; with through-hole for screw M6 with accessories			
Product weight	113 g	178 ... 183 g	111 g	182 g
Dimensions W x L x H	(Installation dimensions); 50.1 mm x 122 mm x 35 mm	(Installation dimensions); 50.1 mm x 150 mm x 45.6 mm	(Installation dimensions); 50.1 mm x 124 mm x 35 mm	(Installation dimensions); 50.1 mm x 153 mm x 45.6 mm
Grid dimension	50.1 mm			

Materials – Interlinking blocks with system supply

Power supply, connection technology	7/8" to NFPA/T3.5.29	M12x1, L-coded to EN 61076-2-111	M18x1	Push-pull to IEC 61076-3-126
Housing material	Reinforced PA			
O-ring material	–	FPM	–	
Sealing material	Polyurethane foam			
Threaded seal material	TPE-U(PU)	–		
Flange material	–	Nickel-plated die-cast zinc	–	Nickel-plated die-cast zinc
Screw material	Nickel-plated steel			
Note on materials	RoHS-compliant; free of halogen; free of phosphoric acid ester			
LABS (PWIS) conformity	VDMA24364-B2-L			

Operating and environmental conditions – System supply for interlinking blocks

Ambient temperature	-20 ... 50 °C
Note on ambient temperature	Note ambient temperature derating according to IEC 61131-2:2017
Storage temperature	-20 ... 70 °C
Corrosion resistance class CRC ¹⁾	1 - Low corrosion stress
Relative humidity	5 - 95%, non-condensing
Nominal operating altitude	<= 2000 m ASL (> 79.5 kPa)
Max. setup altitude	3500 m
Note on max. setup altitude	> 2000 m ASL (< 79.5 kPa) Note ambient temperature derating according to IEC 61131-2:2017
Vibration resistance	Transport application test with severity level 2 to FN 942017-4 and EN 60068-2-6
Note on vibration resistance	SG1 on H-rail SG2 on direct mounting Transport application test with severity level 1 to FN 942017-4 and EN 60068-2-6
Shock resistance	Shock test with severity level 2 to FN 942017-5 and EN 60068-2-27
Note on shock resistance	30 g/11 ms to EN 60068-2-27 SG1 on H-rail SG2 on direct mounting Shock test with severity level 1 to FN 942017-5 and EN 60068-2-27
Material fire test	UL94 V-0 (housing)

1) More information www.festo.com/x/topic/crc

Datasheet – Interlinking block with system supply

Pin allocation, system supply M18x1, 4-pin

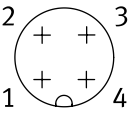
Terminal allocation	Pin	Allocation	Description
	1	24 V	Operating voltage 24 V for electronics and sensors
	2	24 V	Operating voltage 24 V load voltage supply
	3	0 V	Operating voltage 0 V load voltage supply, electronics and sensors
	4	FE	Functional earth

Pin allocation, system supply M12x1, L-coded, 5-pin

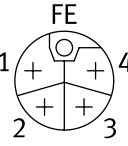
Terminal allocation	Pin	Allocation	Description
	1	24 V	Operating voltage 24 V for electronics and sensors
	2	0 V	Operating voltage 0 V load voltage supply
	3	0 V	Operating voltage 0 V for electronics and sensors
	4	24 V	Operating voltage 24 V load voltage supply
	FE	FE	Functional earth

Pin allocation, system supply 7/8" to NFPA/T3.5.29, 5-pin

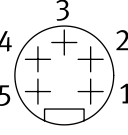
Terminal allocation	Pin	Allocation	Description
	1	0 V	Operating voltage 0 V load voltage supply
	2	0 V	Operating voltage 0 V for electronics and sensors
	3	FE	Functional earth
	4	24 V	Operating voltage 24 V for electronics and sensors
	5	24 V	Operating voltage 24 V load voltage supply

Pin allocation, system supply push-pull to IEC 61076-3-126, 5-pin

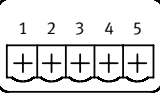



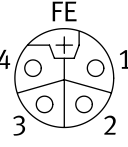

Terminal allocation	Pin	Allocation	Description
	1	24 V	Operating voltage 24 V for electronics and sensors
	2	0 V	Operating voltage 0 V for electronics and sensors
	3	24 V	Operating voltage 24 V load voltage supply
	4	0 V	Operating voltage 0 V load voltage supply
	5	FE	Functional earth

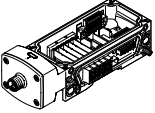
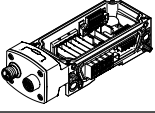
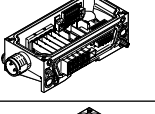
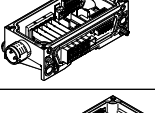
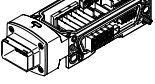
Pin allocation, forwarding supply M12x1, L-coded, 5-pin

Terminal allocation	Pin	Allocation	Description
	1	24 V	Operating voltage 24 V for electronics and sensors
	2	0 V	Operating voltage 0 V load voltage supply
	3	0 V	Operating voltage 0 V for electronics and sensors
	4	24 V	Operating voltage 24 V load voltage supply
	FE	FE	Functional earth

Datasheet – Interlinking block with system supply

Ordering data				
	Power supply, connection technology	Power transmission, function	Part no.	Type
	M12x1, L-coded to EN 61076-2-111	–	8129256	CPX-AP-A-S-1-M12-5P
	M12x1, L-coded to EN 61076-2-111	Incoming electronics/sensors and load and functional earth	8129261	CPX-AP-A-S-2-M12-5P
	M18x1	–	8129254	CPX-AP-A-S-1-M18-4P
	7/8" to NFPA/T3.5.29	–	8129255	CPX-AP-A-S-1-7/8-5P
	Push-pull to IEC 61076-3-126	–	8129253	CPX-AP-A-S-1-PP-5P

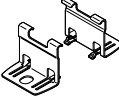
Ordering data – Accessories					
	Description	Cable fitting	Permissible cable diameter	Part no.	Type
Plug connectors for self-assembly					
	Straight socket, M12x1, L-coded to EN 61076-2-111, 5-pin	–	8 - 13 mm for electrical connection 1	8166793	NECL-L12G5-C2-Q10
	Angled socket, M12x1, L-coded to EN 61076-2-111, 5-pin	–	8 - 13 mm for electrical connection 1	8166794	NECL-L12W5-C2-Q10
	Straight plug, M12x1, L-coded to EN 61076-2-111, 5-pin	–	8 - 13 mm for electrical connection 1	8166791	NECL-S-L12G5-C2-Q10
	Angled plug, M12x1, L-coded to EN 61076-2-111, 5-pin	–	8 - 13 mm for electrical connection 1	8166792	NECL-S-L12W5-C2-Q10
	Straight socket, 4-pin	Pg9	6 - 8 mm	18493	NTSD-GD-9
		Pg13	6 - 8 mm	18526	NTSD-GD-13.5
	Angled socket, 4-pin	Pg9	6 - 8 mm	18527	NTSD-WD-9
		Pg11	5 - 11 mm	533119	NTSD-WD-11
	Straight socket, 7/8", 5-pin	–	6 - 12 mm	543107	NECU-G78G5-C2
	Straight socket, plug pattern PP, coding on pin 2 and 5	Pg13.5, hex, AF22	9 - 13 mm	5195383	NECU-M-PPG5PP-C1-PN
Cable seal					
	For push-pull to IEC 61076-3-126	For adapting to cable diameter 6.5 ... 9.5 mm		8079860	NEAU-KD-P4-A1-P5
Mounting					
	For wall mounting			8130844	CAF-M-X5-A

Datasheet – Interlinking block with additional supply

Function

Interlinking blocks ensure the electrical supply of all other CPX-AP-A modules. They have contact rails, from which the other CPX components on the interlinking modules are supplied with power.

The internal division of the power supply makes it possible to switch off specific areas of the sensors and actuators individually.

Area of application

- All voltages are fed through to the next module via the interlinking blocks with additional supply.
- The interlinking blocks with additional supply make all voltages available to an external consumer.
- 24 V DC supply voltage for valves
- 24 V DC supply voltage for outputs

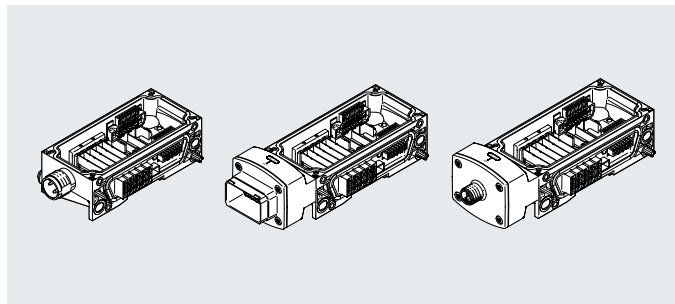

General technical data – Additional supply for interlinking blocks

Mounting position	Any, on H-rail: horizontal
-------------------	----------------------------

General technical data – Interfaces, additional supply for interlinking blocks

Power supply, connection technology	7/8" to NFPA/T3.5.29	M12x1, L-coded to EN 61076-2-111	M18x1	Push-pull to IEC 61076-3-126
Power supply, function	Incoming electronics/sensors and load and functional earth			
Power supply, connection type	Plug			
Power supply, number of pins/wires	5		4	5
Power supply, conductor cross section	1.5 mm ²	2.5 mm ²		

General technical data – Electrical, additional supply for interlinking blocks

Power supply, connection technology	7/8" to NFPA/T3.5.29	M12x1, L-coded to EN 61076-2-111	M18x1	Push-pull to IEC 61076-3-126
Nominal operating voltage DC for electronics/sensors	24 V			
Nominal operating voltage DC load	24 V			
Note on the operating voltage	SELV/PELV power supply units required; note voltage drop			
Note on nominal operating voltage DC	24 V [XD-AR,PL], protected extra-low voltage to IEC 60204-1	24 V [XD-AL,PL], 24 V [XD-AR,PL], protected extra-low voltage to IEC 60204-1	24 V [XD-AR,PL], protected extra-low voltage to IEC 60204-1	24 V [XD-AL,PL], 24 V [XD-AR,PL], protected extra-low voltage to IEC 60204-1
Nominal current	8 A	10 A	8 A	10 A
Max. power supply	2 x 8 A (external fuse required)	2 x 10 A (external fuse required)	2 x 8 A (external fuse required)	2 x 10 A (external fuse required)
Potential separation between the supply voltages electronics/sensors and load/valves	Yes		No	Yes
Protection class	III			
Overvoltage category	II			

Datasheet – Interlinking block with additional supply

General technical data – Mechanical, additional supply for interlinking blocks				
Power supply, connection technology	7/8" to NFPA/T3.5.29	M12x1, L-coded to EN 61076-2-111	M18x1	Push-pull to IEC 61076-3-126
Type of mounting	On H-rail with accessories; with through-hole for M5 screw with accessories; with through-hole for screw M6 with accessories			
Product weight	110 g	174 g	108 g	177 g
Dimensions W x L x H	(Installation dimensions); 50.1 mm x 122 mm x 35 mm	(Installation dimensions); 50.1 mm x 150 mm x 45.6 mm	(Installation dimensions); 50.1 mm x 124 mm x 35 mm	(Installation dimensions); 50.1 mm x 153 mm x 45.6 mm
Grid dimension	50.1 mm			

Materials – Additional supply for interlinking blocks				
Power supply, connection technology	7/8" to NFPA/T3.5.29	M12x1, L-coded to EN 61076-2-111	M18x1	Push-pull to IEC 61076-3-126
Housing material	Reinforced PA			
Sealing material	Polyurethane foam			
Threaded seal material	TPE-U(PU)	–		
Flange material	–	Nickel-plated die-cast zinc	–	Nickel-plated die-cast zinc
Screw material	Nickel-plated steel			
Note on materials	RoHS-compliant; free of halogen; free of phosphoric acid ester			
LABS (PWIS) conformity	VDMA24364-B2-L			

Operating and environmental conditions – Additional supply for interlinking blocks	
Ambient temperature	-20 ... 50 °C
Note on ambient temperature	Note ambient temperature derating according to IEC 61131-2:2017
Storage temperature	-20 ... 70 °C
Corrosion resistance class CRC ¹⁾	1 - Low corrosion stress
Relative humidity	5 - 95%, non-condensing
Nominal operating altitude	<= 2000 m ASL (> 79.5 kPa)
Max. setup altitude	3500 m
Note on max. setup altitude	> 2000 m ASL (< 79.5 kPa) Note ambient temperature derating according to IEC 61131-2:2017
Vibration resistance	Transport application test with severity level 2 to FN 942017-4 and EN 60068-2-6
Note on vibration resistance	SG1 on H-rail SG2 on direct mounting Transport application test with severity level 1 to FN 942017-4 and EN 60068-2-6
Shock resistance	Shock test with severity level 2 to FN 942017-5 and EN 60068-2-27
Note on shock resistance	30 g/11 ms to EN 60068-2-27 SG1 on H-rail SG2 on direct mounting Shock test with severity level 1 to FN 942017-5 and EN 60068-2-27
Material fire test	UL94 V-0 (housing)

1) More information www.festo.com/x/topic/crc

Datasheet – Interlinking block with additional supply

Pin allocation, additional supply M18x1, 4-pin

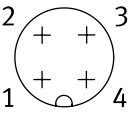
Terminal allocation	Pin	Allocation	Description
	1	n.c.	Not connected
	2	24 V	Operating voltage 24 V load voltage supply
	3	0 V	Operating voltage 0 V load voltage supply
	4	FE	Functional earth

Pin allocation, additional supply M12x1, L-coded, 5-pin

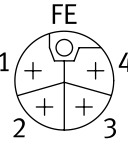
Terminal allocation	Pin	Allocation	Description
	1	n.c.	Not connected
	2	0 V	Operating voltage 0 V load voltage supply
	3	n.c.	Not connected
	4	24 V	Operating voltage 24 V load voltage supply
	FE	FE	Functional earth



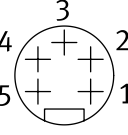

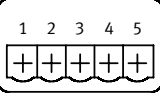

Pin allocation, additional supply 7/8" to NFPA/T3.5.29, 5-pin

Terminal allocation	Pin	Allocation	Description
	1	0 V	Operating voltage 0 V load voltage supply
	2	n.c.	Not connected
	3	FE	Functional earth
	4	n.c.	Not connected
	5	24 V	Operating voltage 24 V load voltage supply

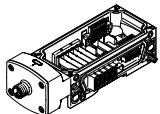
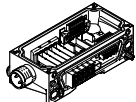
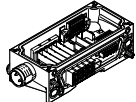
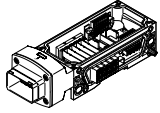
Pin allocation, additional supply push-pull to IEC 61076-3-126, 5-pin

Terminal allocation	Pin	Allocation	Description
	1	n.c.	Not connected
	2	n.c.	Not connected
	3	24 V	Operating voltage 24 V load voltage supply
	4	0 V	Operating voltage 0 V load voltage supply
	5	FE	Functional earth

Datasheet – Interlinking block with additional supply

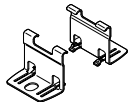
Ordering data					
	Power supply, connection technology	Note on nominal operating voltage DC	Part no.	Type	
	M12x1, L-coded to EN 61076-2-111	24 V [XD-AR,PL]	8129260	CPX-AP-A-AR-1-M12-5P	
		24 V [XD-AL,PL]	8129263	CPX-AP-A-AL-1-M12-5P	
	M18x1	24 V [XD-AR,PL]	8129258	CPX-AP-A-AR-1-M18-4P	
	7/8" to NFPA/T3.5.29	24 V [XD-AR,PL]	8129259	CPX-AP-A-AR-1-7/8-5P	
	Push-pull to IEC 61076-3-126	24 V [XD-AR,PL]	8129257	CPX-AP-A-AR-1-PP-5P	
		24 V [XD-AL,PL]	8129262	CPX-AP-A-AL-1-PP-5P	
Ordering data – Accessories					
	Description	Cable fitting	Permissible cable diameter	Part no.	Type
Plug connectors for self-assembly					
	Straight socket, M12x1, L-coded to EN 61076-2-111, 5-pin	–	8 - 13 mm for electrical connection 1	8166793	NECL-L12G5-C2-Q10
	Angled socket, M12x1, L-coded to EN 61076-2-111, 5-pin	–	8 - 13 mm for electrical connection 1	8166794	NECL-L12W5-C2-Q10
	Straight socket, 4-pin	Pg9	6 - 8 mm	18493	NTSD-GD-9
		Pg13	6 - 8 mm	18526	NTSD-GD-13.5
	Angled socket, 4-pin	Pg9	6 - 8 mm	18527	NTSD-WD-9
		Pg11	5 - 11 mm	533119	NTSD-WD-11
	Straight socket, 7/8", 5-pin	–	6 - 12 mm	543107	NECU-G78G5-C2
	Straight socket, plug pattern PP, coding on pin 2 and 5	Pg13.5, hex, AF22	9 - 13 mm	5195383	NECU-M-PPG5PP-C1-PN
Cable seal					
	For push-pull to IEC 61076-3-126	For adapting to cable diameter 6.5 ... 9.5 mm		8079860	NEAU-KD-P4-A1-P5
Mounting					
	For wall mounting			8130844	CAF-M-X5-A

Datasheet – Interlinking block with forwarding supply

Function

Interlinking blocks ensure the electrical supply of all other CPX-AP-A modules. They have contact rails, from which the other CPX components on the interlinking modules are supplied with power.

The internal division of the power supply makes it possible to switch off specific areas of the sensors and actuators individually.

Area of application

- All voltages are fed through to the next module via the interlinking blocks with forwarding supply.
- The interlinking blocks with forwarding supply make all voltages available to an external consumer.
- 24 V DC supply voltage for valves
- 24 V DC supply voltage for outputs

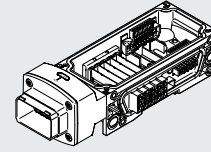

General technical data – Forwarding supply for interlinking blocks

Mounting position	Any, on H-rail: horizontal
-------------------	----------------------------

General technical data – Interfaces, forwarding supply for interlinking blocks

Power transmission, function	Incoming electronics/sensors and load and functional earth
Power transmission, connection type	Plug
Power transmission, number of pins/wires	5

General technical data – Electrical, forwarding supply for interlinking blocks

Nominal operating voltage DC for electronics/sensors	24 V
Nominal operating voltage DC load	24 V
Note on the operating voltage	SELV/PELV power supply units required; note voltage drop
Note on nominal operating voltage DC	2x24 V [XD2,PS,PL], protected extra-low voltage to IEC 60204-1
Nominal current	10 A
Max. power supply	2 x 10 A (external fuse required)
Potential separation between the supply voltages electronics/sensors and load/valves	Yes
Protection class	III
Overvoltage category	II

General technical data – Mechanical, forwarding supply for interlinking blocks

Type of mounting	On H-rail with accessories; with through-hole for M5 screw with accessories; with through-hole for screw M6 with accessories
Product weight	182 g
Dimensions W x L x H	(Installation dimensions); 50.1 mm x 153 mm x 45.6 mm
Grid dimension	50.1 mm

Materials – Forwarding supply for interlinking blocks

Housing material	Reinforced PA
Sealing material	Polyurethane foam
Flange material	Nickel-plated die-cast zinc
Screw material	Nickel-plated steel
Note on materials	RoHS-compliant; free of halogen; free of phosphoric acid ester
LABS (PWIS) conformity	VDMA24364-B2-L

Datasheet – Interlinking block with forwarding supply

Operating and environmental conditions – Forwarding supply for interlinking blocks

Ambient temperature	-20 ... 50 °C
Note on ambient temperature	Note ambient temperature derating according to IEC 61131-2:2017
Storage temperature	-20 ... 70 °C
Corrosion resistance class CRC ¹⁾	1 - Low corrosion stress
Relative humidity	5 - 95%, non-condensing
Nominal operating altitude	<= 2000 m ASL (> 79.5 kPa)
Max. setup altitude	3500 m
Note on max. setup altitude	> 2000 m ASL (< 79.5 kPa) Note ambient temperature derating according to IEC 61131-2:2017
Vibration resistance	Transport application test with severity level 2 to FN 942017-4 and EN 60068-2-6
Note on vibration resistance	SG1 on H-rail SG2 on direct mounting Transport application test with severity level 1 to FN 942017-4 and EN 60068-2-6
Shock resistance	Shock test with severity level 2 to FN 942017-5 and EN 60068-2-27
Note on shock resistance	30 g/11 ms to EN 60068-2-27 SG1 on H-rail SG2 on direct mounting Shock test with severity level 1 to FN 942017-5 and EN 60068-2-27
Material fire test	UL94 V-0 (housing)

1) More information www.festo.com/x/topic/crc

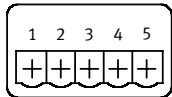

Pin allocation – Forwarding supply

Terminal allocation	Pin	Allocation	Description
	1	24 V	Operating voltage 24 V for electronics and sensors
	2	0 V	Operating voltage 0 V for electronics and sensors
	3	24 V	Operating voltage 24 V load voltage supply
	4	0 V	Operating voltage 0 V load voltage supply
	5	FE	Functional earth

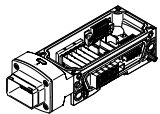
Ordering data

	Power transmission, function	Power transmission, connection type	Part no.	Type
	Incoming electronics/sensors and load and functional earth	Plug	8169617	CPX-AP-A-W-1-PP-5P

Ordering data – Accessories

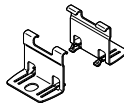
	Description	Cable fitting	Permissible cable diameter	Part no.	Type
Plug connectors for self-assembly					
	Straight socket, plug pattern PP, coding on pin 2 and 5	Pg13.5, hex, AF22	9 - 13 mm	5195383	NECU-M-PPG5PP-C1-PN
Cable seal					
	For push-pull to IEC 61076-3-126	For adapting to cable diameter 6.5 ... 9.5 mm		8079860	NEAU-KD-P4-A1-P5
Mounting					
	For wall mounting			8130844	CAF-M-X5-A

Datasheet – Interlinking module

Function

Interlinking blocks ensure the electrical supply of all other CPX-AP-A modules. They have contact rails, from which the other CPX components on the interlinking modules are supplied with power.

The internal division of the power supply makes it possible to switch off specific areas of the sensors and actuators individually.

Area of application

- All voltages are fed through to the next module by means of the interlinking blocks without supply.
- The connected electronics module for inputs/outputs or bus node taps off the required voltage.

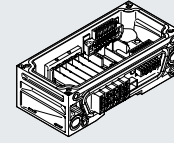

General technical data – Interlinking module for interlinking blocks

Mounting position	Any, on H-rail: horizontal
-------------------	----------------------------

General technical data – Electrical, interlinking module for interlinking blocks

Nominal operating voltage DC for electronics/sensors	24 V
Nominal operating voltage DC load	24 V
Note on nominal operating voltage DC	Protected extra-low voltage to IEC 60204-1
Protection class	III
Overvoltage category	II

General technical data – Mechanical, forwarding supply for interlinking blocks

Type of mounting	On H-rail with accessories; with through-hole for M5 screw with accessories; with through-hole for screw M6 with accessories
Product weight	97 g
Dimensions W x L x H	(Installation dimensions); 50.1 mm x 107.3 mm x 35 mm
Grid dimension	50.1 mm

Materials – Forwarding supply for interlinking blocks

Housing material	Reinforced PA
Sealing material	Polyurethane foam
Screw material	Nickel-plated steel
Note on materials	RoHS-compliant; free of halogen; free of phosphoric acid ester
LABS (PWIS) conformity	VDMA24364-B2-L

Datasheet – Interlinking module

Operating and environmental conditions – Interlinking module for interlinking blocks	
Ambient temperature	-20 ... 50 °C
Note on ambient temperature	Note ambient temperature derating according to IEC 61131-2:2017
Storage temperature	-20 ... 70 °C
Corrosion resistance class CRC ¹⁾	1 - Low corrosion stress
Relative humidity	5 - 95%, non-condensing
Nominal operating altitude	<= 2000 m ASL (> 79.5 kPa)
Max. setup altitude	3500 m
Note on max. setup altitude	> 2000 m ASL (< 79.5 kPa) Note ambient temperature derating according to IEC 61131-2:2017
Vibration resistance	Transport application test with severity level 2 to FN 942017-4 and EN 60068-2-6
Note on vibration resistance	SG1 on H-rail SG2 on direct mounting Transport application test with severity level 1 to FN 942017-4 and EN 60068-2-6
Shock resistance	Shock test with severity level 2 to FN 942017-5 and EN 60068-2-27
Note on shock resistance	30 g/11 ms to EN 60068-2-27 SG1 on H-rail SG2 on direct mounting Shock test with severity level 1 to FN 942017-5 and EN 60068-2-27
Material fire test	UL94 V-0 (housing)

1) More information www.festo.com/x/topic/crc

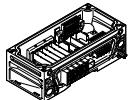
Ordering data			
	Description	Part no.	Type
	Interlinking module	8129251	CPX-AP-A-SB

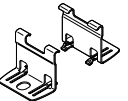
Ordering data – Accessories			
	Description	Part no.	Type
	For wall mounting	8130844	CAF-M-X5-A

Datasheet – Manifold sub-base for valve terminals VTUX

Function

The manifold sub-base for VTUX facilitates a valve terminal VTUX to be operated as a component of the automation system CPX-AP-A.

- Display of power supply and module diagnostics via LED indicators
- Up to 32 valve positions with up to 32 solenoid coils
- Short-circuit shutdown, short-circuit diagnostics and switching cycle counter

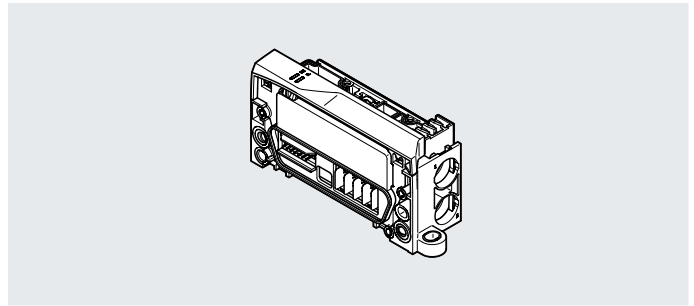

General technical data – Manifold sub-base for VTUX

Valve terminal design	Valve sizes can be mixed
Max. address volume for outputs	4 bytes
Max. no. of valve positions	32
Max. no. of solenoid coils	32
Module parameters	Configuration of voltage monitoring load supply PL; behaviour in error state
Diagnostics via LED	Diagnostics per module; power supply load
Communication Diagnostics via internal communication	Switch-off load supply; overvoltage electronics/sensors; undervoltage electronics/sensors
Undervoltage load/valves (diagnostic message)	21.1
Reverse polarity protection	Yes

Technical data – Electrics; manifold sub-base for VTUX

Nominal operating voltage DC for electronics/sensors	24 V
Nominal operating voltage DC load	24 V
Permissible voltage fluctuations, electronics/sensors	± 25%
Permissible voltage fluctuations, load	± 10%
Note on the operating voltage	SELV/PELV power supply units required; note voltage drop
Power failure buffering	10 ms
Intrinsic current consumption at nominal operating voltage, electronics/sensors	Typical 27 mA
Intrinsic current consumption at nominal operating voltage, load	typ. 13 mA
Power consumption at 24 VDC	650 mW
Power supply, function	Incoming electronics/sensors and load
Power transmission, function	Outgoing electronics/sensors and load
Electrical isolation of outputs between channel - internal communication	Yes
Fuse protection (short circuit)	Internal electronic fuse per channel
Inductive protective circuit	Integrated
Overvoltage category	II
Protection against direct and indirect contact	PELV, SELV
Pollution degree	2

Datasheet – Manifold sub-base for valve terminals VTUX

Technical data – Mechanical system; manifold sub-base for VTUX

Type of mounting	Tie rods
Type of mounting sub-base	Via through-hole
Product weight	126.7 g
Dimensions W x L x H	35.2 mm x 104.3 mm x 55.8 mm
Max. tightening torque for wall mounting	6 Nm
Connection position	On the side
Pneumatic connection 1	For 15 mm cartridge
Pneumatic connection 5	For 15 mm cartridge

Materials – Manifold sub-base for VTUX

Sub-base material	Reinforced PA
Cover material	Reinforced PA
Sealing material	NBR
Clamp material	High-alloy stainless steel
Sleeve material	High-alloy stainless steel
Nut material	High-alloy stainless steel
Note on materials	RoHS-compliant
LABS (PWIS) conformity	VDMA24364-B1/B2-L

Operating and environmental conditions – Manifold sub-base for VTUX

Ambient temperature	-5 ... 50°C
Storage temperature	-20 ... 70°C
Corrosion resistance class CRC ¹⁾	2 - Moderate corrosion stress
Relative humidity	5 - 95%
Nominal operating altitude	< 3000 m above sea level
Vibration resistant	Transport application test with severity level 2 to FN 942017-4 and EN 60068-2-6
Shock resistance	Shock test with severity level 2 to FN 942017-5 and EN 60068-2-27
CE marking (see declaration of conformity) ²⁾	To EU EMC Directive To EU RoHS Directive
UKCA marking (see declaration of conformity)	To UK EMC regulations To UK RoHS regulations
KC marking	KC EMC
Certification	RCM
Degree of protection	IP65

1) More information www.festo.com/x/topic/crc

2) More information www.festo.com/catalogue/.../Support/downloads.

Ordering data

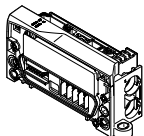
		Part no.	Type
	Manifold sub-base for valve terminals VTUX	8189594	VABX-A-P-EL-E12-APA-SHUH

Ordering data – Accessories

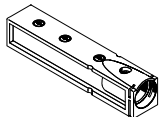
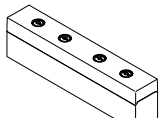
		Description	Part no.	Type
Plate				
	Position function 1-64: UD	Plate for ducted exhaust air, without cartridge, for mounting on manifold sub-base for valve terminals VTUX	8191794	VABF-XA-12-M2-QX
	Position function 1-64: US	Exhaust plate for mounting on manifold sub-base for valve terminals VTUX	8191741	VABF-XA-12-M1-C

Datasheet – Pneumatic interface for valve terminals VTSA

Function

The pneumatic interface facilitates a valve terminal VTSA to be operated as a component of the automation system CPX-AP-A.

- Indication of status and error messages via LED indicators
- Up to 32 valve positions with up to 32 solenoid coils
- Voltage supply and forwarding possible
- Short circuit shutdown, short circuit diagnostics and switching cycle counter

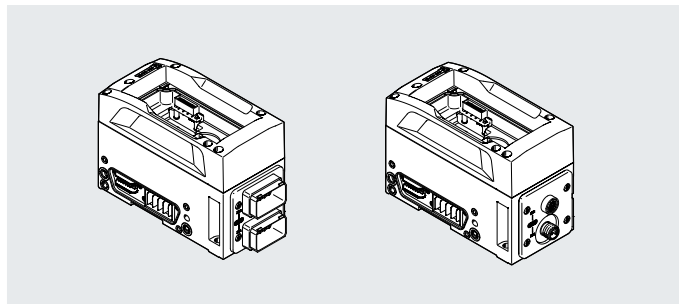

Implementation

Pneumatic interface for valve terminals VSTA, like an interlinking module, have a module slot for a CPX-AP-A module.

All CPX-AP-A modules can be mounted in this slot, e.g. bus interface and input/output modules.

The pneumatic interface includes mounting options for mounting on wall, H-rail or support system.

General technical data – Pneumatic interface VTSA

Module code (hex/dec)	0x3040/12352d	0x3041/12353d	0x3042/12354d	0x3044/12356d	0x3045/12357d
Electrical actuation	Fieldbus				
Communication interface, protocol	AP				
Valve terminal interface	Type 46, VTSA-F-CB			Type 44, VTSA, type 45, VTSA-F	
Max. no. of valve positions	12 with double solenoid valves; 24 with single solenoid valves			16 with double solenoid valves; 32 with single solenoid valves	
Max. no. of solenoid coils	24			32	
Module parameters	Diagnostics activated via overload/short circuit; condition counter limit value/actual value; configuration of voltage monitoring of load supply PL; behaviour in error state				
Diagnostics via LED	Diagnostics per module; power supply load				
Diagnostics via internal communication	Switch-off load supply; communication error; short circuit/overload output signal; overvoltage electronics/sensors; overvoltage load; undervoltage electronics/sensors; undervoltage load				
Undervoltage load/valves (diagnostic message)	≤ 21.6 V				
Internal cycle time	< 1 ms				
Reverse polarity protection	Yes				

Technical data – Power supply interface, pneumatic interface VTA

Module code (hex/dec)	0x3040/12352d	0x3041/12353d	0x3042/12354d	0x3044/12356d	0x3045/12357d
Power supply, function	–	Incoming electronics/sensors and load and functional earth	–	–	Incoming electronics/sensors and load and functional earth
Power supply, connection type	–	Plug	–	–	Plug
Power supply, connection technology	–	M12x1, L-coded to EN 61076-2-111	Push-pull to IEC 61076-3-126	–	Push-pull to IEC 61076-3-126
Power supply, number of pins/wires	–	5	–	–	5
Power transmission, function	–	Outgoing electronics/sensors and load and functional earth	–	–	Outgoing electronics/sensors and load and functional earth
Power transmission, connection type	–	Socket	–	–	Socket
Power transmission, connection technology	–	M12x1, L-coded to EN 61076-2-111	Push-pull to IEC 61076-3-126	–	Push-pull to IEC 61076-3-126
Power transmission, number of pins/wires	–	5	–	–	5
Nominal current	–	16 A	–	–	16 A

Datasheet – Pneumatic interface for valve terminals VTSA

Technical data – Electrical, pneumatic interface VTSA					
Module code (hex/dec)	0x3040/12352d	0x3041/12353d	0x3042/12354d	0x3044/12356d	0x3045/12357d
Nominal operating voltage DC for electronics/sensors	24 V				
Nominal operating voltage DC load	24 V				
Permissible voltage fluctuations, electronics/sensors	± 25%				
Permissible voltage fluctuations, load	± 10%				
Note on the operating voltage	SELV/PELV power supply units required; note voltage drop				
Power failure buffering	10 ms				
Max. power supply	–	2 x 16 A (external fuse required)		–	2 x 16 A (external fuse required)
Intrinsic current consumption at nominal operating voltage, electronics/sensors	Typical 42 mA			Typical 27 mA	
Intrinsic current consumption at nominal operating voltage, load	Typical 15 mA			Typical 17 mA	
Potential separation between the supply voltages electronics/sensors and load/valves	Yes				
Fuse protection (short circuit)	Internal electronic fuse protection per valve output				
Protection class	III				
Overvoltage category	II				
Pollution degree	2				

Technical data – Mechanical, pneumatic interface VTSA					
Module code (hex/dec)	0x3040/12352d	0x3041/12353d	0x3042/12354d	0x3044/12356d	0x3045/12357d
Type of mounting	With through-hole for M6 screw				
Product weight	1246 g	1306 g	1325 g	1245 g	1328 g
Dimensions W x L x H	70.5 mm x 142 mm x 102.6 mm	70.5 mm x 154.4 mm x 102.6 mm	70.5 mm x 160.65 mm x 102.6 mm	70.5 mm x 142 mm x 102.6 mm	70.5 mm x 160.65 mm x 102.6 mm

Materials – Pneumatic interface VTSA					
Module code (hex/dec)	0x3040/12352d	0x3041/12353d	0x3042/12354d	0x3044/12356d	0x3045/12357d
Housing material	Aluminium				
Cover material	Powder-coated die-cast zinc				
O-ring material	–	FPM	–	–	–
Sealing material	NBR, PUR				
Flange material	–	Nickel-plated die-cast zinc		–	Nickel-plated die-cast zinc
Screw material	Nickel-plated steel				
Note on materials	RoHS-compliant				
LABS (PWIS) conformity	VDMA24364-B2-L				

Datasheet – Pneumatic interface for valve terminals VTSA

Operating and environmental conditions – Pneumatic interface VTSA

Ambient temperature	-20 ... 50 °C
Note on ambient temperature	Note ambient temperature derating according to IEC 61131-2:2017
Storage temperature	-20 ... 70 °C
Corrosion resistance class CRC ¹⁾	0 - no corrosion stress
Relative humidity	5 - 95%, non-condensing
Nominal operating altitude	<= 2000 m ASL (> 79.5 kPa)
Max. setup altitude	3500 m
Note on max. setup altitude	> 2000 m ASL (< 79.5 kPa) Note ambient temperature derating according to IEC 61131-2:2017
Vibration resistance	Transport application test with severity level 2 to FN 942017-4 and EN 60068-2-6
Note on vibration resistance	SG2 on wall mounting
Shock resistance	Shock test with severity level 2 to FN 942017-5 and EN 60068-2-27
Note on shock resistance	SG2 on wall mounting

1) More information www.festo.com/x/topic/crc

Pin allocation, system supply plug M12x1, L-coded, 5-pin

Terminal allocation	Pin	Allocation	Description
	1	24 V	Operating voltage 24 V for electronics and sensors
	2	0 V	Operating voltage 0 V load voltage supply
	3	0 V	Operating voltage 0 V for electronics and sensors
	4	24 V	Operating voltage 24 V load voltage supply
	FE	FE	Functional earth

Pin allocation, forwarding supply socket M12x1, L-coded, 5-pin

Terminal allocation	Pin	Allocation	Description
	1	24 V	Operating voltage 24 V for electronics and sensors
	2	0 V	Operating voltage 0 V load voltage supply
	3	0 V	Operating voltage 0 V for electronics and sensors
	4	24 V	Operating voltage 24 V load voltage supply
	FE	FE	Functional earth

Pin allocation, system supply push-pull to IEC 61076-3-126, 5-pin





Terminal allocation	Pin	Allocation	Description
	1	24 V	Operating voltage 24 V for electronics and sensors
	2	0 V	Operating voltage 0 V for electronics and sensors
	3	24 V	Operating voltage 24 V load voltage supply
	4	0 V	Operating voltage 0 V load voltage supply
	5	FE	Functional earth

Pin allocation – Forwarding supply

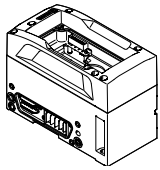
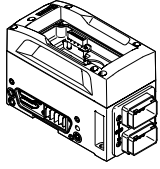
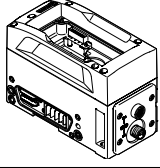
Terminal allocation	Pin	Allocation	Description
	1	24 V	Operating voltage 24 V for electronics and sensors
	2	0 V	Operating voltage 0 V for electronics and sensors
	3	24 V	Operating voltage 24 V load voltage supply
	4	0 V	Operating voltage 0 V load voltage supply
	5	FE	Functional earth

Datasheet – Pneumatic interface for valve terminals VTSA

Ordering data						
	Power supply, function	Power supply, connection technology	Valve terminal interface	Module code (hex/dec)	Part no.	Type
	–	–	Type 44, VTSA, type 45, VTSA-F	0x3044/12356d	8154036	VABA-S6-1-X5
			Type 46, VTSA-F-CB	0x3040/12352d	8154037	VABA-S6-1-X5-CB
	Incoming electronics/sensors and load and functional earth	Push-pull to IEC 61076-3-126	Type 44, VTSA, type 45, VTSA-F	0x3045/12357d	8154039	VABA-S6-1-X5-F4
			Type 46, VTSA-F-CB	0x3042/12354d	8154040	VABA-S6-1-X5-F4-CB
		M12x1, L-coded to EN 61076-2-111	Type 46, VTSA-F-CB	0x3041/12353d	8154038	VABA-S6-1-X5-F3-CB

Ordering data – Accessories						
	Description	Cable fitting	Permissible cable diameter	Part no.	Type	
Plug connectors for self-assembly						
	Straight socket, M12x1, L-coded to EN 61076-2-111, 5-pin	–	8 - 13 mm for electrical connection 1	8166793	NECL-L12G5-C2-Q10	
	Angled socket, M12x1, L-coded to EN 61076-2-111, 5-pin	–	8 - 13 mm for electrical connection 1	8166794	NECL-L12W5-C2-Q10	
	Straight plug, M12x1, L-coded to EN 61076-2-111, 5-pin	–	8 - 13 mm for electrical connection 1	8166791	NECL-S-L12G5-C2-Q10	
	Angled plug, M12x1, L-coded to EN 61076-2-111, 5-pin	–	8 - 13 mm for electrical connection 1	8166792	NECL-S-L12W5-C2-Q10	
	Straight socket, plug pattern PP, coding on pin 2 and 5	Pg13.5, hex, AF22	9 - 13 mm	5195383	NECU-M-PPG5PP-C1-PN	
Cable seal						
	For push-pull to IEC 61076-3-126	For adapting to cable diameter 6.5 ... 9.5 mm		8079860	NEAU-KD-P4-A1-P5	

Datasheet – Pneumatic interface for valve terminals MPA-S

Function

The pneumatic interface for MPA-S facilitates a valve terminal MPA-S to be operated as a component of the automation system CPX-AP-A.

- Display of power supply and module diagnostics via LED indicators

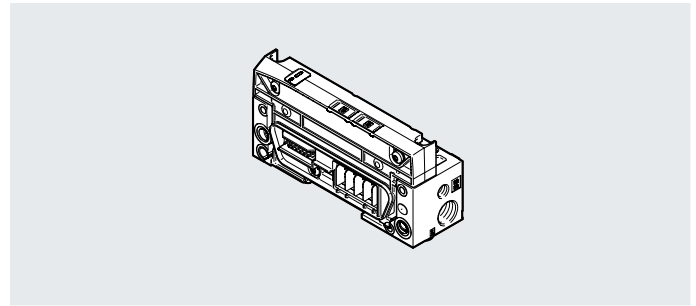
**General technical data – Pneumatic interface MPA-S**

Module code (hex/dec)	0x3052/12370d, 0x3053/12371d
Electrical actuation	AP interface
Communication interface, protocol	AP
Diagnostics via LED	Diagnostics per module
Communication Diagnostics via internal communication	Communication errors; overvoltage electronics/sensors; undervoltage electronics/sensors
Internal cycle time	1 ms
Reverse polarity protection	Yes
Note on reverse polarity protection	Self-protection
Mounting position	Any, on H-rail: horizontal

Technical data – Electrical, pneumatic interface MPA-S

Valve terminal interface	Type 32, MPA-FB-AP-VI
Nominal operating voltage DC for electronics/sensors	24 V
Nominal operating voltage DC load	24 V
Permissible voltage fluctuations, electronics/sensors	± 25%
Permissible voltage fluctuations, load	± 25%
Note on the operating voltage	SELV/PELV power supply units required; note voltage drop
Power failure buffering	10 ms
Intrinsic current consumption at nominal operating voltage, electronics/sensors	Typical 35 mA
Potential separation between the supply voltages electronics/sensors and load/valves	Yes
Fuse protection (short circuit)	Additional fuse
Protection class	III
Overvoltage category	II
Pollution degree	2

Technical data – Mechanical, pneumatic interface MPA-S

Module code (hex/dec)	0x3052/12370d	0x3053/12371d
Type of mounting	With through-hole for M4 screw	
Product weight	207 g	
Dimensions W x L x H	34.1 mm x 107.3 mm x 55.1 mm	
Width	34.1 mm	
Length	107.3 mm	
Pneumatic connection 1	G1/4	
Pilot air port 12/14	M7	
Integrated function	Flat plate silencer, ducted exhaust air	
Pilot air supply	Internal	External

Datasheet – Pneumatic interface for valve terminals MPA-S

Materials – Pneumatic interface MPA-S

Housing material	Die-cast aluminium
Cover material	Reinforced PBT
Sealing material	Polyurethane foam
Screw material	Galvanised steel
Note on materials	RoHS-compliant
LABS (PWIS) conformity	VDMA24364-B2-L

Operating and environmental conditions – Pneumatic interface MPA-S

Ambient temperature	-20 ... 50°C
Note on ambient temperature	Note ambient temperature derating according to IEC 61131-2:2017
Storage temperature	-20 ... 70°C
Corrosion resistance class CRC ¹⁾	1 - Low corrosion stress
Relative humidity	5 - 95%, non-condensing
Nominal operating altitude	<= 2000 m ASL (> 79.5 kPa)
Max. setup altitude	3,500 m
Note on max. setup altitude	> 2000 m ASL (< 79.5 kPa) Note ambient temperature derating according to IEC 61131-2:2017
Vibration resistant	Transport application test with severity level 2 to FN 942017-4 and EN 60068-2-6
Note on vibration resistance	SG2 on wall mounting
Shock resistance	Shock test with severity level 2 to FN 942017-5 and EN 60068-2-27
Note on shock resistance	SG2 on wall mounting
Degree of protection	IP65; IP67
Note on degree of protection	In mounted state

1) More information www.festo.com/x/topic/crc

Ordering data

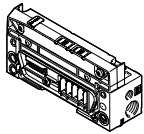
		Part no.	Type
	Pneumatic interface for valve terminals MPA-S	Internal pilot air supply	8137156 VMPA-AP-EPL-G
		External pilot air supply	8137154 VMPA-AP-EPL-E

Datasheet

Dimensions

Download CAD data → www.festo.com

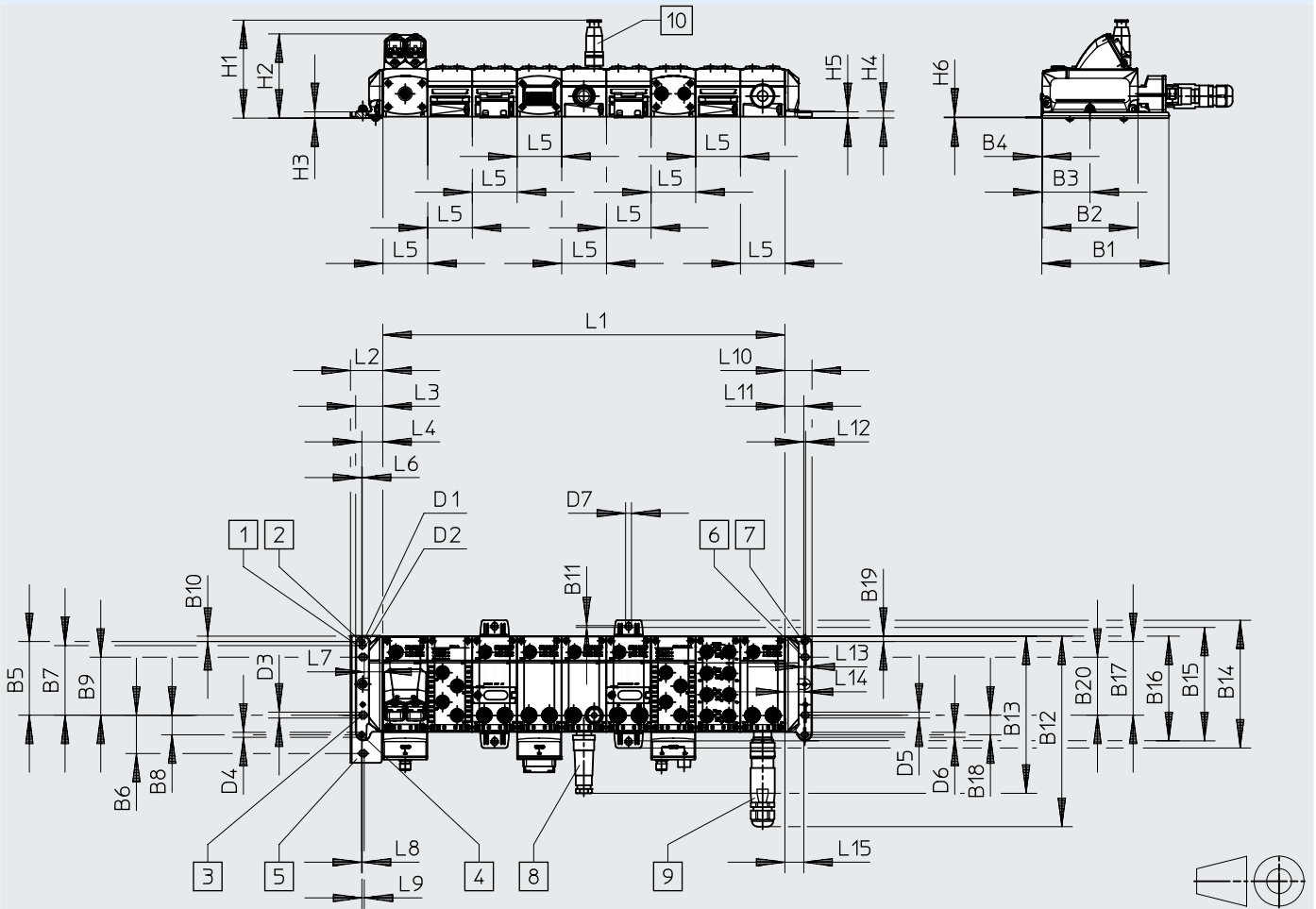

- [1] Mounting hole for M5 screws
- [2] Mounting hole for M6 screws
- [3] Mounting hole for M6 screw
- [4] Mounting hole for M5 screw
- [5] Mounting bracket for system assembly
- [6] Mounting hole for M6 screw
- [7] Mounting hole for M5 screw
- [8] M18 plug
- [9] 7/8" plug
- [10] Plug M12x1

	B1	B2	B3	B4	B5	B6	B7	B8	B9	B10	B11	B12	B13	B14	B15	B16	B17	B18	B19	B20
CPX-AP-A	142.5	107.3	53.7	0.5	82.5	43.1	78	22.1	65	6	2	197.5	176.1	143.3	127.3	117.2	82.5	22.1	6	65

	D1	D2	D3	D4	D5	D6	D7	H1	H2	H3	H4	H5	H6
CPX-AP-A	5.7	6.7	6.7	5.7	6.7	5.7	6.6	109.6	94.2	7	7.6	6.8	0.8

	L1 ¹⁾	L2	L3	L4	L5	L6	L7	L8	L9	L10	L11	L12	L13	L14	L15
CPX-AP-A	nx 50.1	36.4	30.4	23.4	50.1	0.5	20.9	0.8	2.5	30.4	21.2	2	2	21.6	21.2

1) n = Number of interlinking blocks