

One-way flow control valve VFOE

FESTO

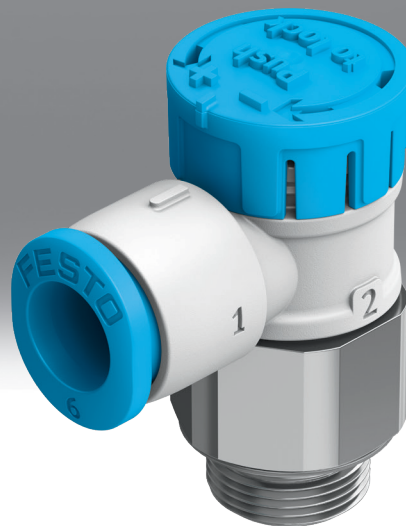

Characteristics

At a glance

[Further information → online](#)

One-way flow control valve for direct mounting on the drive

- Low-cost solution for standard applications
- Simple and reliable adjustment of the speed of a pneumatic cylinder
- Extremely easy assembly
- Fast commissioning
- Compact dimensions
- Suitable for use in accordance with ATEX declaration from Festo for zones 1, 2 and 21, 22

Product segmentation



Festo Core Range

Solves the majority of your automation tasks

With the Festo Core Range, we have selected the most important products and functions from our broad product catalogue, and added the quickest delivery. The Core Range offers you the best value with the expected high Festo quality.

- Quickest delivery, worldwide – wherever, whenever
- Expected high Festo quality
- Easy and fast to select

Diagrams

[Further information → online](#)



The diagrams shown in this document are also available online. These can be used to display precise values.

Function

One-way flow control valves regulate the piston speed of pneumatic drives as they advance and retract. This is achieved through the appropriate control of the flow rate of compressed air in the exhaust air or supply air direction.

[E] One-way flow control valve for exhaust air

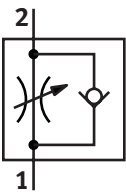

The throttle function only works in the exhaust air direction, the non-return function works in the opposite direction.

Exhaust air version recognisable by the blue rotary knob.

[S] One-way flow control valve for supply air

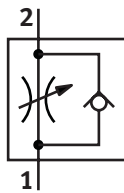

The throttle function only works in the supply air direction, the non-return function works in the opposite direction.

Supply air version recognisable by the light blue rotary knob.

Special material properties

[F1A] Recommended for production plants for manufacturing lithium-ion batteries, F1A

Metals with copper, zinc or nickel as the main component are excluded from use. Exceptions are nickel in steels, chemically nickel-plated surfaces, circuit boards, cables, electrical plug connectors and coils

Application note: Foreign particles can adhere to the product or form during installation. Depending on the application, it may be necessary to purge the product with clean compressed air, to clean it after installation and to operate it with ducted exhaust air.

Characteristics

Package unit

Packaging quantity in pieces (standard: 1)

Type code

001		Series
VFOE	One-way flow control valve	
002		Design
L	L-shape	
003		Function
E	One-way flow control valve for exhaust air	
S	One-way flow control valve for supply air	
004		Adjusting component
T	Rotary knob with detent	
005		Pneumatic connection 2
G12	G1/2	
G14	G1/4	
G18	G1/8	
G38	G3/8	
M5	M5	
M7	M7	
R12	R1/2	
R14	R1/4	
R18	R1/8	
R38	R3/8	

006		Pneumatic connection 1
Q4	Push-in connector 4 mm	
Q6	Push-in connector 6 mm	
Q8	Push-in connector 8 mm	
Q10	Push-in connector 10 mm	
Q12	Push-in connector 12 mm	
007		Special material properties
	None	
F1A	Recommended for production plants for manufacturing lithium-ion batteries, F1A	
008		Package unit
	Standard	
P20	20	
P50	50	

Datasheet

General technical data – VFOE-LE

Pneumatic connection, port 2	M5	G1/8	G1/4	G3/8	G1/2	R1/8	R1/4	R3/8	R1/2
Pneumatic connection, port 1	QS-4	QS-4	QS-6	QS-8	QS-12	QS-4	QS-6	QS-8	QS-12
	QS-6	QS-6	QS-8	QS-10		QS-6	QS-8	QS-10	
Valve function	Exhaust air one-way flow control function								
Type of actuation	Manual								
Mounting position	optional								
Adjustment component	Rotary knob with detent								
Type of mounting	Screw-in								
Rotatability	360°/no continuous swivelling permissible								
Nominal torque	2 Nm	5 Nm	10 Nm	13 Nm	15 Nm	–			
Tolerance for nominal tightening torque	± 20%					–			
Max. tightening torque	2.4 Nm	6 Nm	12 Nm	15.6 Nm	18 Nm	–			
Product weight	3.3 g	9.5 g	16 g	29.5 g	49.5 g	9.5 g	16 g	29.5 g	49.5 g

General technical data – VFOE-LS

Pneumatic connection, port 2	M5	M7	G1/8	R1/8
Pneumatic connection, port 1	QS-4		QS-4	
	QS-6		QS-6	
Valve function	Supply air one-way flow control function			
Type of actuation	Manual			
Mounting position	optional			
Adjustment component	Rotary knob with detent			
Type of mounting	Screw-in			
Rotatability	360°/no continuous swivelling permissible			
Nominal torque	2 Nm	3 Nm	5 Nm	–
Tolerance for nominal tightening torque	± 20%			–
Max. tightening torque	2.4 Nm	3.6 Nm	6 Nm	–
Product weight	3.3 g	4 g	9.5 g	

Operating and environmental conditions – Special material properties: none

Operating pressure complete temperature range	0.02 ... 1 MPa
Operating pressure complete temperature range	0.2 ... 10 bar
Operating pressure complete temperature range	2.9 ... 145 psi
Operating medium	Compressed air to ISO 8573-1:2010 [7:4:4]
Note on operating and pilot medium	Lubricated operation possible (in which case lubricated operation will always be required)
Ambient temperature	-10 ... 60°C
Media temperature	-10 ... 60°C
Corrosion resistance class CRC ¹⁾	1 - Low corrosion stress

1) More information www.festo.com/x/topic/kbk

Datasheet

Operating and environmental conditions – Special material properties: F1A

Operating pressure complete temperature range	0.02 ... 1 MPa
Operating pressure complete temperature range	0.2 ... 10 bar
Operating pressure complete temperature range	2.9 ... 145 psi
Operating medium	Compressed air to ISO 8573-1:2010 [7:4:4]
Note on operating and pilot medium	Lubricated operation possible (in which case lubricated operation will always be required)
Ambient temperature	-10 ... 60°C
Media temperature	-10 ... 60°C
Corrosion resistance class CRC ¹⁾	0 - No corrosion stress

1) More information www.festo.com/x/topic/kbk

Materials – Special material properties: none

Material housing	PBT
Material cover	PBT
Material release ring	PBT
Material threaded bolt	Galvanised steel
Material static seals	NBR
Material dynamic seals	HNBR
Note on materials	RoHS-compliant
LABS (PWIS) conformity	VDMA24364 zone III
Cleanroom class	Class 4 according to ISO 14644-1
ATEX declaration	For zone 1, 2, 21, 22, The information in the certificate must be observed!

Materials – special material properties: F1A

Material threaded bolt	Steel, chemically nickel-plated
Suitability for the production of Li-ion batteries	Metals with more than 1% by mass of copper, zinc or nickel by mass are excluded from use. Exceptions are nickel in steel, chemically nickel-plated surfaces, printed circuit boards, cables, electrical plug connectors and coils

Standard nominal flow rate q_{nN} at 0.6 → 0.5 MPa as a function of spindle revolutions n for threaded connection M5 (exhaust air)

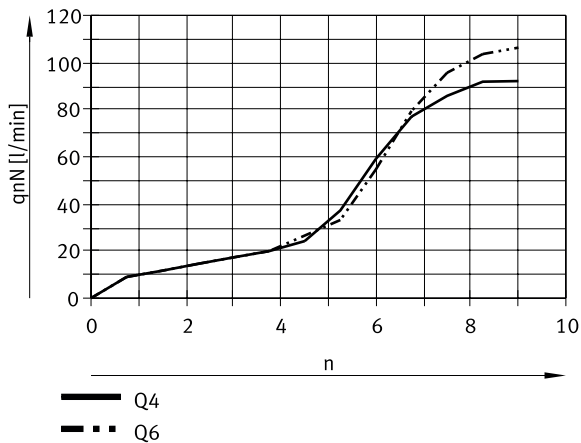

Datasheet

Standard flow q_n at 0.6 → 0 MPa as a function of spindle revolutions n for threaded connection M5 (exhaust air)

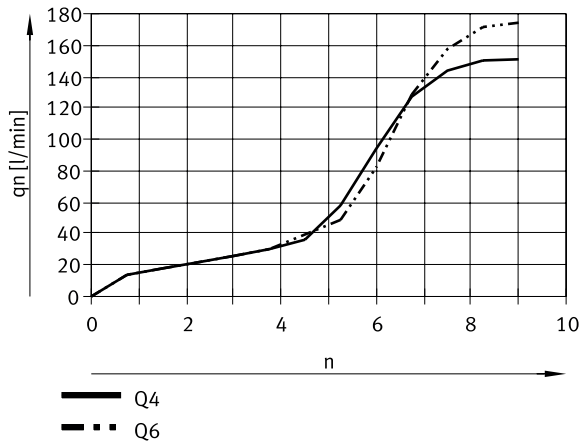

Standard nominal flow rate q_{nN} at 0.6 → 0.5 MPa as a function of spindle revolutions n for threaded connection G1/8, R1/8 (exhaust air)

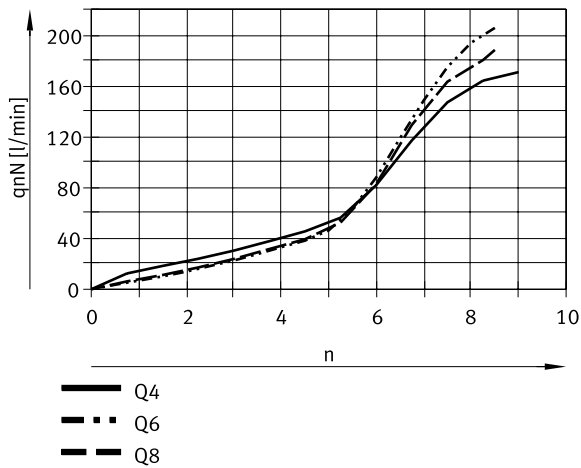

Standard flow q_n at 0.6 → 0 MPa as a function of spindle revolutions n for threaded connection G1/8, R1/8 (exhaust air)

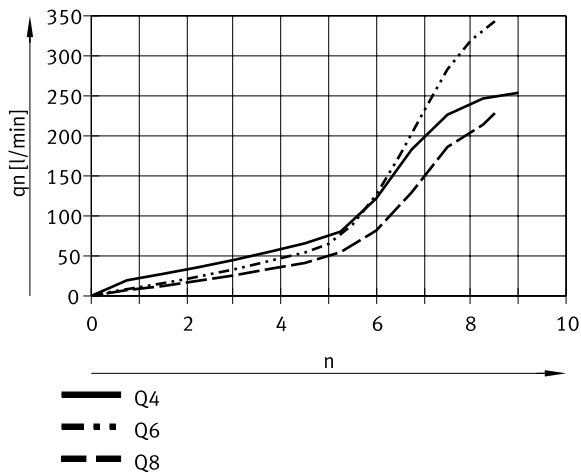

Datasheet

Standard nominal flow rate q_{nN} at 0.6 → 0.5 MPa as a function of spindle revolutions n for threaded connection G1/4, R1/4 (exhaust air)

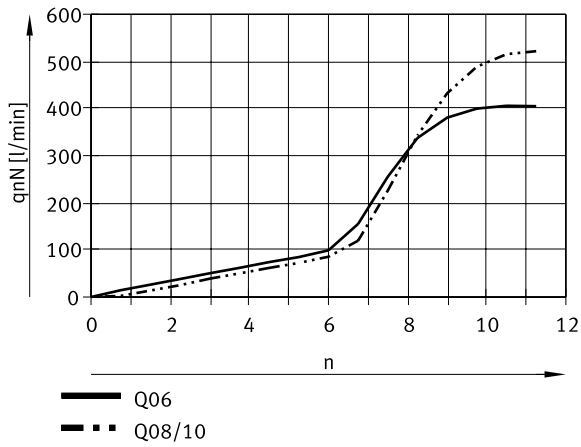

Standard flow q_n at 0.6 → 0 MPa as a function of spindle revolutions n for threaded connection G1/4, R1/4 (exhaust air)

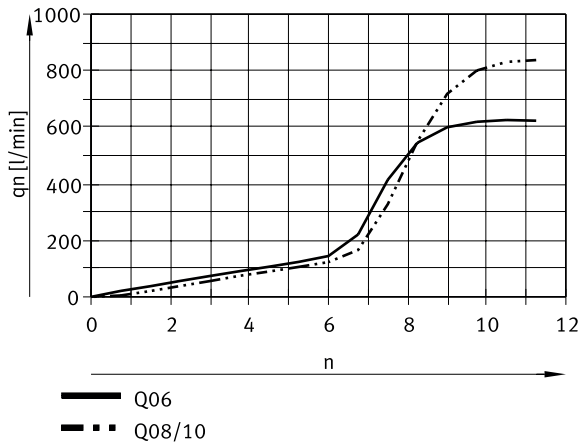

Standard nominal flow rate q_{nN} at 0.6 → 0.5 MPa as a function of spindle revolutions n for threaded connection G3/8, R3/8 (exhaust air)

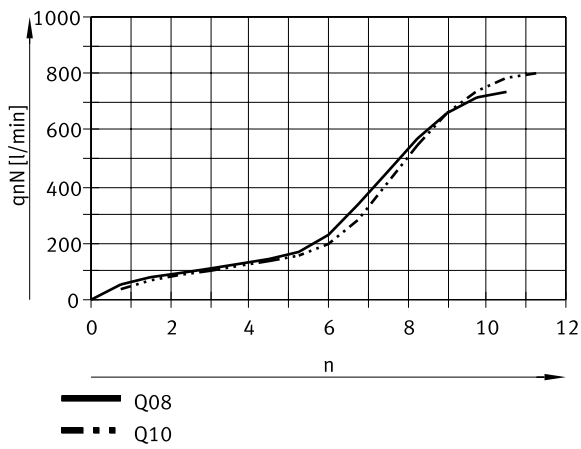

Datasheet

Standard flow q_n at 0.6 → 0 MPa as a function of spindle revolutions n for threaded connection G3/8, R3/8 (exhaust air)

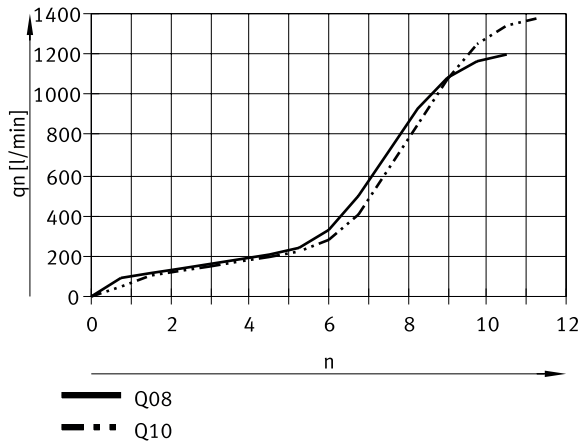

Standard nominal flow rate q_{nN} at 0.6 → 0.5 MPa as a function of spindle revolutions n for threaded connection G1/2, R1/2 (exhaust air)

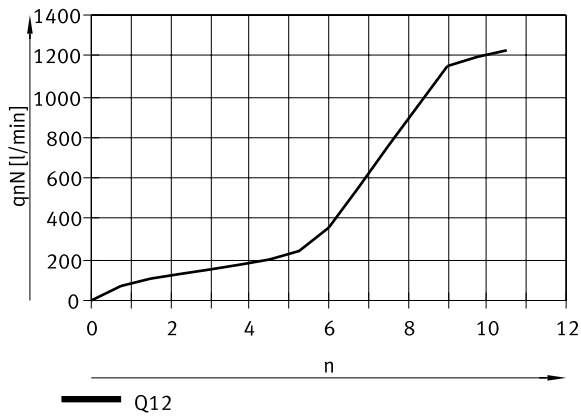

Standard flow q_n at 0.6 → 0 MPa as a function of spindle revolutions n for threaded connection G1/2, R1/2 (exhaust air)

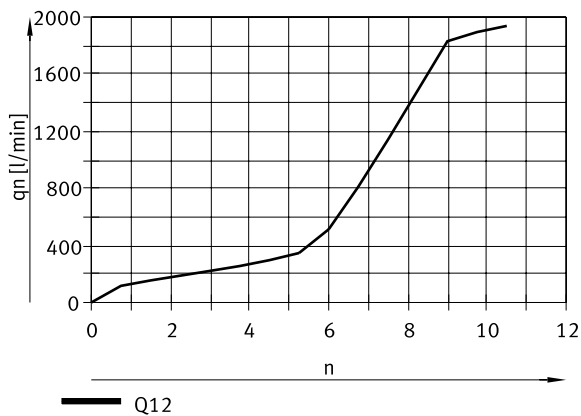

Datasheet

Standard nominal flow rate q_{nN} at 0.6 → 0.5 MPa as a function of spindle revolutions n for threaded connection M5, M7 (supply air)

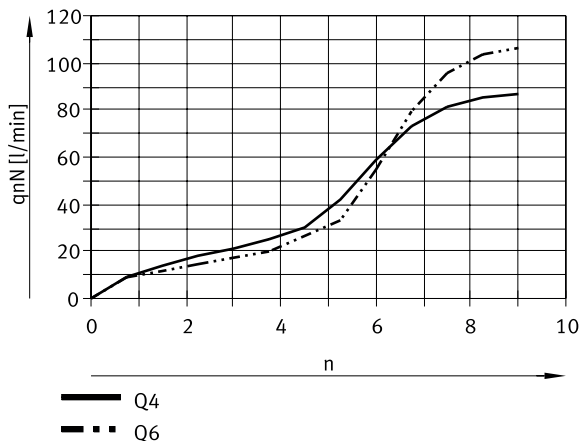

Standard flow q_n at 0.6 → 0 MPa as a function of spindle revolutions n for threaded connection M5, M7 (supply air)

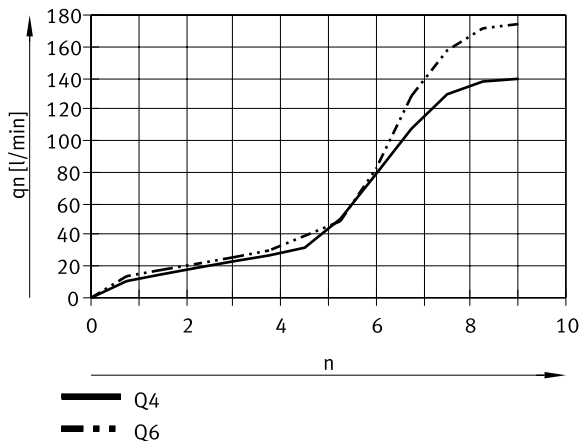

Standard nominal flow rate q_{nN} at 0.6 → 0.5 MPa as a function of spindle revolutions n for threaded connection G1/8, R1/8 (supply air)

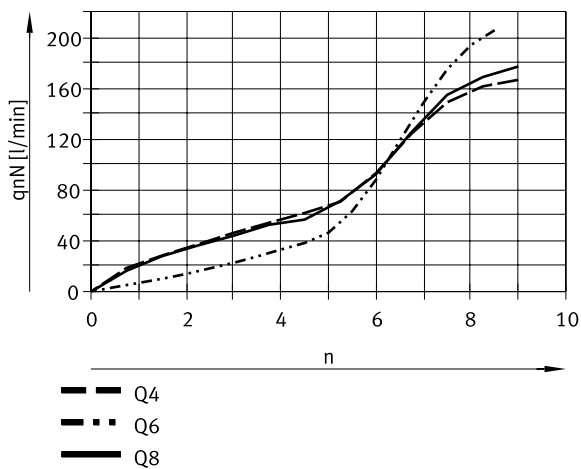

Datasheet

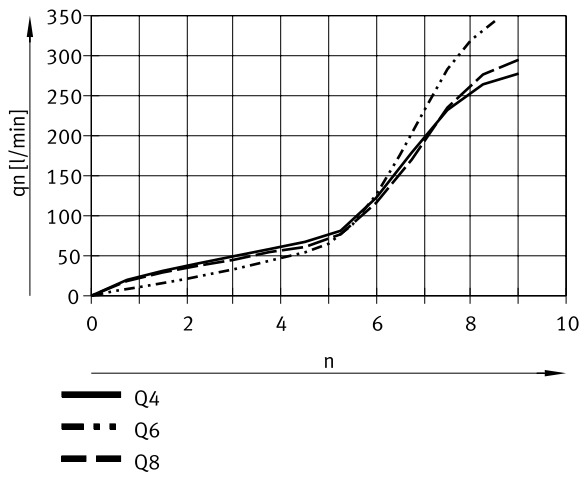
Standard flow q_n at 0.6 → 0 MPa as a function of spindle revolutions n for threaded connection G1/8, R1/8 (supply air)

Dimensions

Dimensions – VFOE-...-M.../G..

Download CAD data → www.festo.com

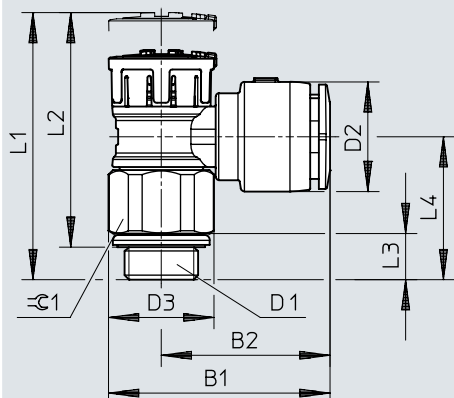

VFOE-...-M.../G..	B1	B2	D1	D2 ø	D3 ø	L1		L2		L3	L4	≅ 1
						1)	2)	1) (max.)	2)			
VFOE-...-M5-Q4	19,6	14,6	M5	9	10	27,6	26,6	25	24	4,1	13,9	9
VFOE-...-M5-Q6	22,6	17,6	M5	11	10	27,6	26,6	25	24	4,1	13,9	9
VFOE-...-M7-Q4	19,6	14,6	M7	9	10	29,5	28,5	25	24	6	15,8	9
VFOE-...-M7-Q6	22,6	17,6	M7	11	10	29,5	28,5	25	24	6	15,8	9
VFOE-...-G18-Q4	23,3	16,3	G1/8	9	14	31,7	30,3	27,4	26	6,1	18,9	13
VFOE-...-G18-Q6	24,4	17,4	G1/8	11	14	31,7	30,3	27,4	26	6,1	18,9	13
VFOE-...-G18-Q8	29,3	22,3	G1/8	14,5	14	31,7	30,3	27,4	26	6,1	18,9	13
VFOE-...-G14-Q6	28,3	19,3	G1/4	11	17,9	38,6	36,7	33,9	32	7	22	16
VFOE-...-G14-Q8	30	21	G1/4	14,5	17,9	38,6	36,7	33,9	32	7	22	16
VFOE-...-G14-Q10	35,1	26,2	G1/4	16,5	17,9	38,6	36,7	33,9	32	7	22	16
VFOE-...-G38-Q8	34,5	23,3	G3/8	14,5	22,4	44,1	41,9	38,2	36	8,5	26,2	21
VFOE-...-G38-Q10	39,6	28,4	G3/8	17,5	22,4	44,1	41,9	38,2	36	8,5	26,2	21
VFOE-...-G12-Q12	46,8	33,3	G1/2	20,8	27	53,7	50,8	46,8	43,9	9,5	31	24

1) Unlocked

2) Locked

Dimensions

Dimensions – VFOE-...-R..

Download CAD data → www.festo.com

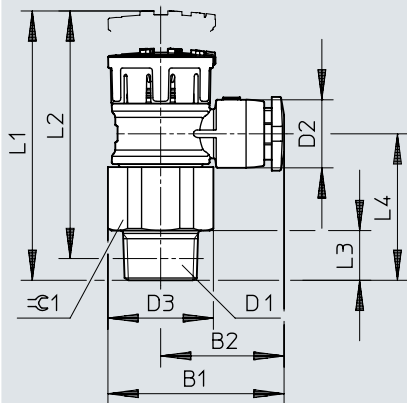



VFOE-...-R..	B1	B2	D1	D2 ø	D3 ø	L1		L2		L3	L4	≈ 1
						1)	2)	1) (max.)	2)			
VFOE-...-R18-Q4	23,3	16,3	R1/8	9	14	32,2	30,8	29,2	27,8	6,6	19,4	13
VFOE-...-R18-Q6	24,4	17,4	R1/8	11	14	32,2	30,8	29,2	27,8	6,6	19,4	13
VFOE-...-R18-Q8	29,3	22,3	R1/8	14,5	14	32,2	30,8	29,2	27,8	6,6	19,4	13
VFOE-...-R14-Q6	28,3	19,3	R1/4	11	17,9	41,2	39,3	36,7	34,8	10,1	25,1	16
VFOE-...-R14-Q8	30	21	R1/4	14,5	17,9	41,2	39,3	36,7	34,8	10,1	25,1	16
VFOE-...-R14-Q10	35,1	26,2	R1/4	17,5	17,9	41,2	39,3	36,7	34,8	10,1	25,1	16
VFOE-...-R38-Q8	34,5	23,3	R3/8	14,5	22,4	45,2	43	40,7	38,5	10,1	27,8	21
VFOE-...-R38-Q10	39,6	28,4	R3/8	17,5	22,4	45,2	43	40,7	38,8	10,1	27,8	21
VFOE-...-R12-Q12	46,8	33,3	R1/2	20,8	27	55,8	52,9	50,8	47,9	12,1	33,6	24

- 1) Unlocked
- 2) Locked

Ordering data

Ordering data – Exhaust air one-way flow control function						
	Pneumatic connection, port 2	Pneumatic connection, port 1	Standard nominal flow rate in flow control direction	Standard nominal flow rate in blocked direction	Part no.	Type
	M5	QS-4	90 l/min	50 ... 90 l/min	8095432	VFOE-LE-T-M5-Q4-P50
					★ 8068723	VFOE-LE-T-M5-Q4
	G1/8	QS-6	105 l/min	60 ... 105 l/min	★ 8068724	VFOE-LE-T-M5-Q6
		QS-4	150 l/min	90 ... 150 l/min	★ 8068725	VFOE-LE-T-G18-Q4
		QS-6	165 l/min	110 ... 200 l/min	8095433	VFOE-LE-T-G18-Q6-P50
	G1/4				★ 8068726	VFOE-LE-T-G18-Q6
		QS-8	170 l/min	130 ... 200 l/min	★ 8068727	VFOE-LE-T-G18-Q8
		QS-6	400 l/min	350 ... 450 l/min	★ 8068728	VFOE-LE-T-G14-Q6
		QS-8	500 l/min	370 ... 500 l/min	★ 8068729	VFOE-LE-T-G14-Q8
	G3/8				8095434	VFOE-LE-T-G14-Q8-P50
		QS-10			★ 8068730	VFOE-LE-T-G14-Q10
		QS-8	720 l/min	600 ... 900 l/min	★ 8068731	VFOE-LE-T-G38-Q8
	G1/2	QS-10	750 l/min	700 ... 1000 l/min	8095435	VFOE-LE-T-G38-Q10-P20
					★ 8068732	VFOE-LE-T-G38-Q10
	R1/8	QS-12	1,200 l/min	600 ... 1200 l/min	8095436	VFOE-LE-T-G12-Q12-P20
					★ 8068733	VFOE-LE-T-G12-Q12
	R1/4	QS-4	150 l/min	90 ... 150 l/min	★ 8068734	VFOE-LE-T-R18-Q4
		QS-6	165 l/min	110 ... 200 l/min	★ 8068735	VFOE-LE-T-R18-Q6
		QS-8	170 l/min	130 ... 200 l/min	★ 8068736	VFOE-LE-T-R18-Q8
	R3/8	QS-6	400 l/min	350 ... 450 l/min	★ 8068737	VFOE-LE-T-R14-Q6
QS-8		500 l/min	370 ... 500 l/min	★ 8068738	VFOE-LE-T-R14-Q8	
QS-10				★ 8068739	VFOE-LE-T-R14-Q10	
R1/2	QS-8	720 l/min	600 ... 900 l/min	★ 8068740	VFOE-LE-T-R38-Q8	
	QS-10	750 l/min	700 ... 1000 l/min	★ 8068741	VFOE-LE-T-R38-Q10	
	QS-12	1,200 l/min	600 ... 1200 l/min	★ 8068742	VFOE-LE-T-R12-Q12	

Ordering data – Supply air one-way flow control function						
	Pneumatic connection, port 2	Pneumatic connection, port 1	Standard nominal flow rate in flow control direction	Standard nominal flow rate in blocked direction	Part no.	Type
	M5	QS-4	85 l/min	50 ... 90 l/min	★ 8068743	VFOE-LS-T-M5-Q4
		QS-6	100 l/min	60 ... 100 l/min	★ 8068744	VFOE-LS-T-M5-Q6
	M7	QS-4	85 l/min	50 ... 90 l/min	★ 8068745	VFOE-LS-T-M7-Q4
		QS-6	100 l/min	60 ... 100 l/min	★ 8068746	VFOE-LS-T-M7-Q6
	G1/8	QS-4	165 l/min	90 ... 165 l/min	★ 8068747	VFOE-LS-T-G18-Q4
		QS-6	170 l/min	110 ... 200 l/min	★ 8068748	VFOE-LS-T-G18-Q6
		QS-8		130 ... 200 l/min	★ 8068749	VFOE-LS-T-G18-Q8
	R1/8	QS-4	165 l/min	90 ... 165 l/min	★ 8068750	VFOE-LS-T-R18-Q4
		QS-6	170 l/min	110 ... 200 l/min	★ 8068751	VFOE-LS-T-R18-Q6
		QS-8		130 ... 200 l/min	★ 8068752	VFOE-LS-T-R18-Q8

Ordering data Products for battery production – exhaust air one-way flow control function						
	Pneumatic connection, port 2	Pneumatic connection, port 1	Standard nominal flow rate in flow control direction	Standard nominal flow rate in blocked direction	Part no.	Type
	M5	QS-4	90 l/min	50 ... 90 l/min	8157642	VFOE-LE-T-M5-Q4-F1A

Ordering data

Ordering data Products for battery production – exhaust air one-way flow control function						
	Pneumatic connection, port 2	Pneumatic connection, port 1	Standard nominal flow rate in flow control direction	Standard nominal flow rate in blocked direction	Part no.	Type
	M5	QS-6	105 l/min	60 ... 105 l/min	8157641	VFOE-LE-T-M5-Q6-F1A
	R1/8	QS-4	150 l/min	90 ... 150 l/min	8157640	VFOE-LE-T-R18-Q4-F1A
		QS-6	165 l/min	110 ... 200 l/min	8157639	VFOE-LE-T-R18-Q6-F1A
		QS-8	170 l/min	130 ... 200 l/min	8157638	VFOE-LE-T-R18-Q8-F1A
	R1/4	QS-6	400 l/min	350 ... 450 l/min	8157637	VFOE-LE-T-R14-Q6-F1A
		QS-8	500 l/min	370 ... 500 l/min	8157636	VFOE-LE-T-R14-Q8-F1A
		QS-10			8157635	VFOE-LE-T-R14-Q10-F1A
	R3/8	QS-8	720 l/min	600 ... 900 l/min	8157634	VFOE-LE-T-R38-Q8-F1A
		QS-10	750 l/min	700 ... 1000 l/min	8157633	VFOE-LE-T-R38-Q10-F1A
	R1/2	QS-12	1,200 l/min	600 ... 1200 l/min	8157631	VFOE-LE-T-R12-Q12-F1A

Ordering data Products for battery production – Supply air one-way flow control function						
	Pneumatic connection, port 2	Pneumatic connection, port 1	Standard nominal flow rate in flow control direction	Standard nominal flow rate in blocked direction	Part no.	Type
	M5	QS-4	85 l/min	50 ... 90 l/min	8157630	VFOE-LS-T-M5-Q4-F1A
		QS-6	100 l/min	60 ... 100 l/min	8157629	VFOE-LS-T-M5-Q6-F1A
	R1/8	QS-4	165 l/min	90 ... 165 l/min	8157628	VFOE-LS-T-R18-Q4-F1A
		QS-6	170 l/min	110 ... 200 l/min	8157627	VFOE-LS-T-R18-Q6-F1A
		QS-8		130 ... 200 l/min	8157626	VFOE-LS-T-R18-Q8-F1A