

## Data sheet

## Cable socket ASI-SD-PG-M12

- Flat cable socket for connecting AS-Interface stations to the AS-Interface bus system
- M12 connection
- Reverse polarity protected
- Detachable connection



## General technical data

Mounting position	Any
Type of mounting	With union nut
Electrical connection	Straight socket
	4-pin
	Screw terminal
Connection cross section [mm <sup>2</sup> ]	0.75
Cable connector	Pg9
Operating voltage range [V AC]	0 ... 125
Current rating [A]	3
Degree of protection	IP65/IP67 (assembled)
Product weight [g]	27.6

## Materials

Housing	PA
Pin contacts	Bronze
Union nut	Nickel-plated
Housing colour	Black
Note on materials	RoHS-compliant

## Operating and environmental conditions

Ambient temperature [°C]	-40 ... +85
--------------------------	-------------

## Dimensions

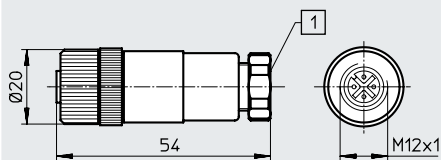
Download CAD data → [www.festo.com](http://www.festo.com)

[1] Seal for AS-Interface cable

## Ordering data

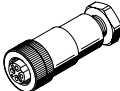
	Electrical connection	Part no.	Type
	Straight socket, 4-pin, screw terminal	<b>18789</b>	<b>ASI-SD-PG-M12</b>

## Data sheet

### Cable socket ASI-SD-FK

### Blanking plug ASI-SD-FK-BL

- Flat cable socket for connecting AS-Interface stations to the AS-Interface bus system
- 0° and 180° version
- Reverse polarity protected
- Detachable connection
- 2-pin
- Blanking plug for sealing unused connections

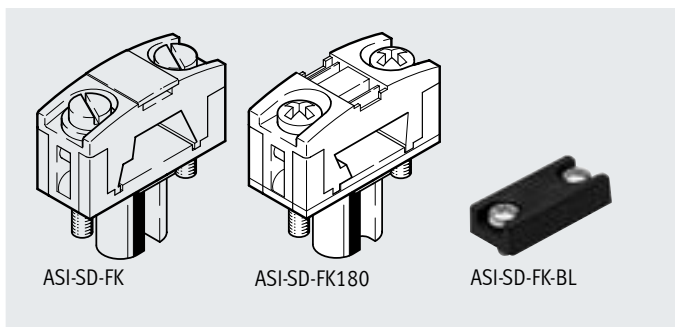

General technical data		ASI-SD-FK	ASI-SD-FK180	ASI-SD-FK-BL
Type		ASI-SD-FK	ASI-SD-FK180	ASI-SD-FK-BL
Mounting position		Any		
Type of mounting		Via through-hole		
Electrical connection		Straight socket, 2-pin	Straight socket, 2-pin	–
Operating voltage range	[V AC]	0 ... 60	0 ... 60	–
	[V DC]	0 ... 75	0 ... 75	–
Current rating	[A]	3	3	–
Connection type		Insulation displacement technology	Insulation displacement technology	–
Connection cross section	[mm <sup>2</sup> ]	1.5	1.5	–
Degree of protection		IP65 (in assembled state)		
Product weight	[g]	6.8	6.2	3

Materials		ASI-SD-FK	ASI-SD-FK180	ASI-SD-FK-BL
Type		ASI-SD-FK	ASI-SD-FK180	ASI-SD-FK-BL
Housing		PA	PA	–
Pin contacts		Bronze	Bronze	–
Note on materials		RoHS-compliant	RoHS-compliant	RoHS-compliant

Operating and environmental conditions		ASI-SD-FK	ASI-SD-FK180	ASI-SD-FK-BL
Type		ASI-SD-FK	ASI-SD-FK180	ASI-SD-FK-BL
Ambient temperature	[°C]	–5 ... +50	–5 ... +50	–20 ... +70
Storage temperature	[°C]	–30 ... +85	–30 ... +85	–20 ... +70

Data sheet

Dimensions

ASI-SD-FK

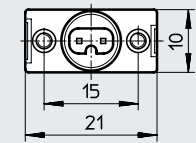

- [1] Contact pins for flat cable contacting
- [2] Mounting option for inscription labels IBS-6x10

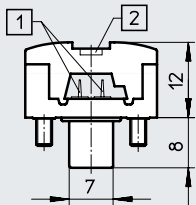

ASI-SD-FK180

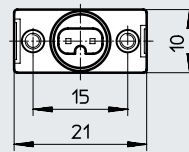

- [1] Contact pins for flat cable contacting
- [2] Mounting option for inscription labels IBS-6x10

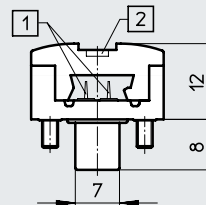

ASI-SD-FK-BL

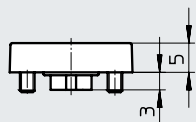

- [1] Retaining screws M2.5x6

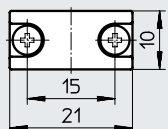

Ordering data

	Part no.	Type
Flat cable socket for connecting AS-Interface stations	18785	ASI-SD-FK
Flat cable socket for connecting AS-Interface stations, flat cable turned by 180°	196089	ASI-SD-FK180
Cover plate for sealing unused AS-Interface flat cable connections	196090	ASI-SD-FK-BL