

Stopper cylinder STAF

FESTO



Key features

At a glance

- Single-acting or double-acting
- Fast and simple set-up of conveyor lines
- Workpiece carriers, pallets and packages weighing up to 150 kg can be safely stopped
- Simple actuation via valve terminal (e.g. together with other cylinders in one installation site)
- Space-saving sensing via integrated proximity switches
- Flange-mounted solenoid valve permits fast actuation even at great distances and with individual stopper cylinders

Roller version



Mounting options

Flange mounting

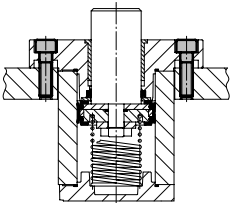

Applications

For heavy loads

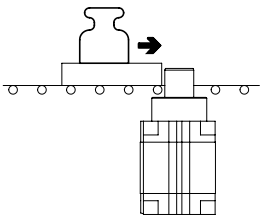

Safety

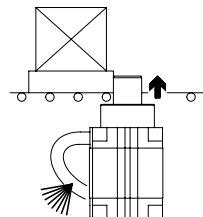

Thanks to the spring return of the piston rod in case of pressure failure

Product range overview

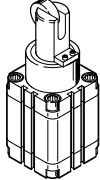
Function	Design	Type	Piston \varnothing [mm]	Stroke [mm]	Type of mounting Via flange	Cushioning	Position sensing	→ Page/Internet
						P	A	
Single- or double-acting	Roller version							
		STAF....P-A-R	80	30, 40	■	■	■	4

Functional sequence and type codes

Functional sequence

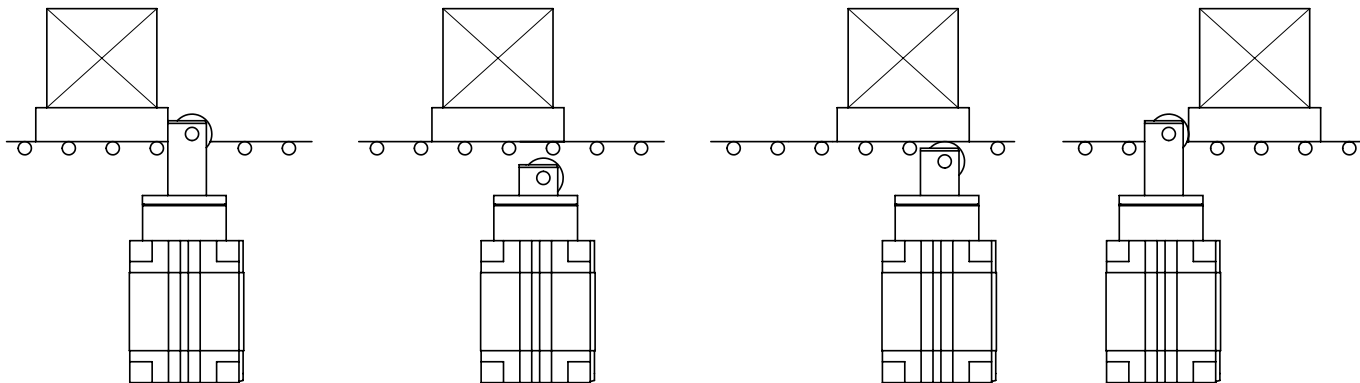

1. Sudden braking of the workpiece carrier via the piston rod.
2. The workpiece carrier is released by actuating the cylinder.
3. The cylinder then advances by means of spring force or compressed air until the roller makes contact with the workpiece carrier. The workpiece carrier continues to move forward.
4. After the workpiece carrier has passed, the cylinder advances to its end position. The next workpiece carrier can then be stopped.

Type codes

001	Series	004	Cushioning
STAF	Stopper cylinder with flange mounting, single-or double-acting	P	Elastic cushioning rings/plates on both sides
002	Piston diameter	005	Position sensing
80	80	A	For proximity sensor
003	Stroke	006	Version
...	30 ... 40	R	Roller version

Peripherals overview

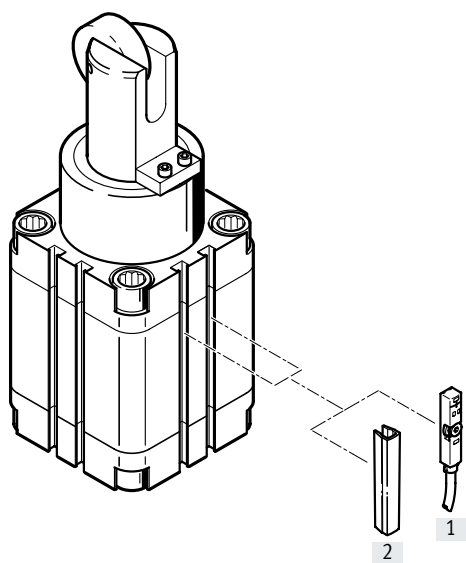



Accessories		Description	→ Page/Internet
[1]	Proximity switch SME/SMT-8	Can be integrated in the cylinder profile barrel	13
[2]	Slot cover ABP	For protection against contamination	13

Data sheet

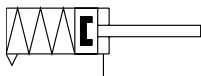
Function



-  - Diameter
80 mm

-  - Stroke length
30, 40 mm

 www.festo.com

-  - **Note**

Contact with liquids should be avoided during use.



General technical data		
Pneumatic connection		G1/8
Stroke	[mm]	30, 40
Piston rod diameter	[mm]	50
Operating pressure	[bar]	1 ... 10
Operating medium		Compressed air to ISO 8573-1:2010 [7:-:-]
Design		Piston cylinder with spring return
Cushioning		Elastic cushioning rings/pads at both ends
Position sensing		Via proximity switch
Type of mounting		Via through-hole With female thread
Mounting position		Any
Mode of operation		Single- or double-acting
Protection against rotation		Flat-sided piston rod
Ambient temperature ¹⁾	[°C]	0 ... +60
Product weight	[g]	4630, 4850

1) Note operating range of proximity switches

-  - **Note**

This product conforms to ISO 1179-1 and ISO 228-1.

Forces [N]		
Piston ø	80	
Stroke	30	40
Permissible impact force on the advanced piston rod	14600	13300
Spring torque	79 ... 115	101 ... 170

The impact force refers here to the maximum of a force-time curve with unknown details during impact/braking of the moving mass. It acts perpendicular to the direction of motion of the piston rod. Treating the elastic components as linear springs, it is possible to use the permissible impact force to calculate a permissible impact energy for use in selecting the right stopper.

The stopper must not be switched below this force. Depending on the type of load to be stopped, it is a good idea to provide an elastic buffer to cushion the impact, reduce the noise and optimise the impact energy.

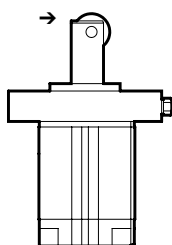

→ = Direction of impact force

Data sheet

Permissible load m as a function of conveyor speed v

The values in the graph opposite are based on the assumption that the workpiece carrier is fitted with a flexible buffer with a deformation path of 1 mm.

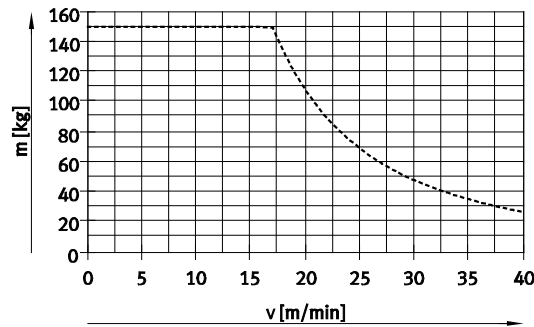

..... STAF-80-...-P-A-R

Permissible lateral force F_Q during the switching operation as a function of the pressure p

The "permissible lateral force during switching operation" refers here to the force which is still applied perpendicularly to the direction of movement of the piston rod even after the end of the impact or braking process, e.g. as a result of belts that are still running or the downhill force of a steep raceway. The force acts statically. The stopper can be switched below this force. A certain minimum pressure must be applied in order to guarantee the cylinder function.

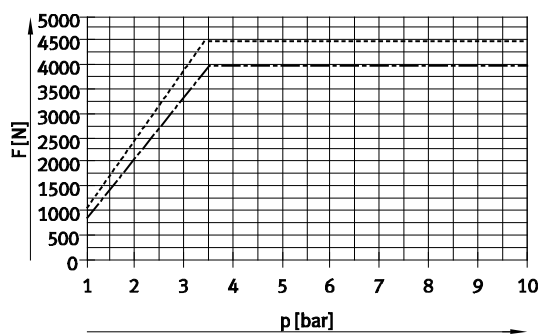

..... STAF-80-30-P-A-R
 - - - - - STAF-80-40-P-A-R

Note
 Selection aid → page 9

Materials

Sectional view

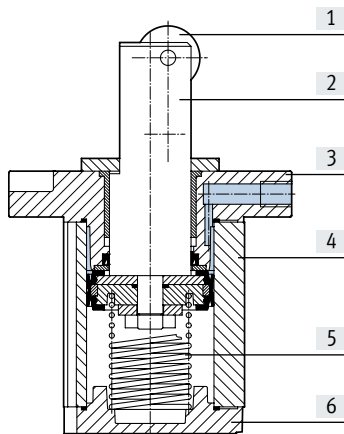

Stopper cylinders	
[1] Role	Steel
[2] Piston rod	Stainless steel
[3] Flange	Die-cast aluminium
[4] Cylinder barrel	Anodised aluminium
[5] Springs	Spring steel
[6] Cover	Anodised aluminium
- Seals	NBR
- Note on materials	Free of copper and PTFE

Data sheet

Dimensions

Download CAD data → www.festo.com

Flange mounting

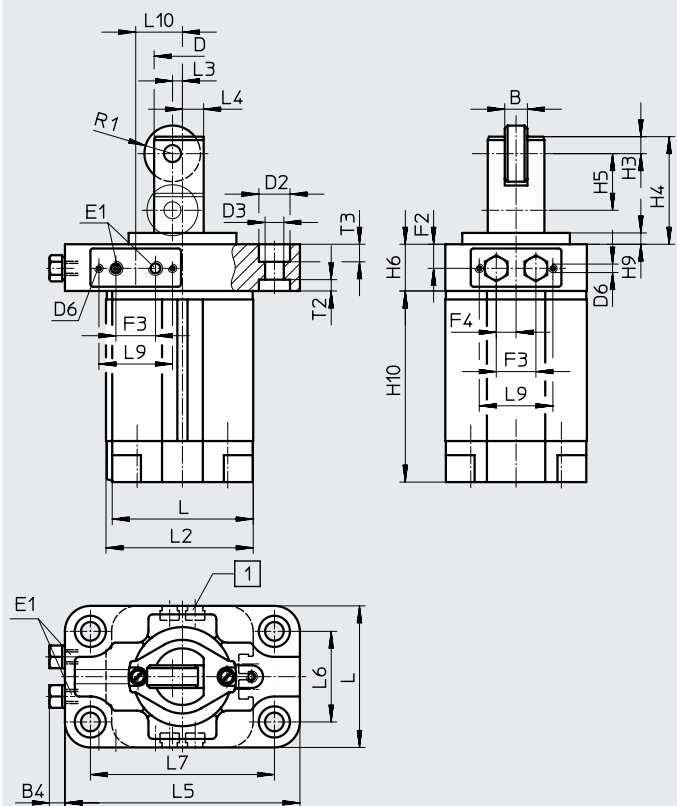

[1] Sensor slot for proximity switch SME/SMT-8

∅	Stroke	B	B4	D	D2	D3	D6	E1	F2	F3	F4	H3	H4	H5	H6
[mm]	[mm]			∅	∅	∅									
80	30	18	4.5	50	18	11	M4	G1/8	11	17	4.5	10	63	30	22
	40												73	40	

∅	Stroke	H9	H10	L	L2	L3	L4	L5	L6	L7	L9	L10	R1	T2	T3
[mm]	[mm]														
80	30	8	119	107	111	11	18	160	63	135	36	18.5	18	6	6
	40		129												

Note
 This product conforms to ISO 1179-1 and ISO 228-1.

Ordering data			
Piston ∅	Stroke	Part no.	Type
[mm]	[mm]		
80	30	164886	STAF-80-30-P-A-R
	40	164894	STAF-80-40-P-A-R

Data sheet

Selection aid

Stopping a pallet

The stopper cylinder is used to brake an individual pallet.

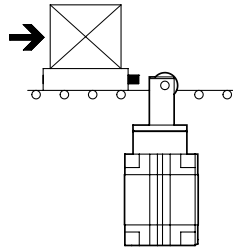

Example

Assuming:

Friction factor $\mu = 0.1$

Conveyor speed $v = 10 \text{ m/min}$

Pallet with workpiece $m = 40 \text{ kg}$

Operating pressure $p = 6 \text{ bar}$

Selection: stopper cylinder STAF-80-30-P-A-R

1. Checking the permissible load

The maximum permissible load at a conveyor speed of 10 m/min is 150 kg. This means that a total load of 40 kg for the pallet and the workpiece is permissible.

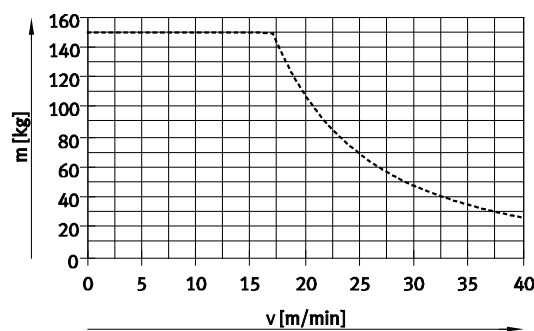

..... STAF-80-...-P-A-R

2. Checking the permissible lateral force during the switching operation

Lateral force $F_Q =$ frictional force F_{friction}

$$F_{\text{friction}} = \mu \times m \times g$$

$$= 0.1 \times 40 \text{ kg} \times 9.81 \text{ m/s}^2$$

$$= \text{approx. } 40 \text{ N}$$

The maximum permissible lateral force at an operating pressure of 6 bar is 4500 N.

This means that a lateral force of 40 N is permissible.

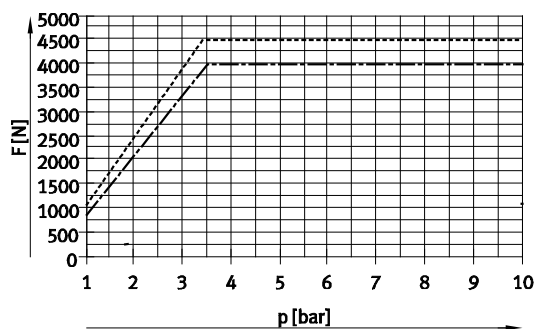

..... STAF-80-30-P-A-R
 - - - - - STAF-80-40-P-A-R

Data sheet

Selection aid

Stopping or separating several pallets

The stopper cylinder is used to separate pallets. Further pallets accumulate behind the pallets already resting against the stopper cylinder. It is therefore vital that a buffer is mounted between the pallets (e.g. elastomer components).

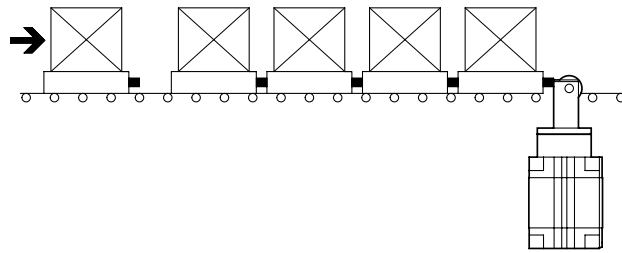

Example

Assuming:

Friction factor $\mu = 0.1$

Conveyor speed $v = 10 \text{ m/min}$

Pallet with workpiece $m = 40 \text{ kg}$

Operating pressure $p = 6 \text{ bar}$

Maximum number of pallets accumulating simultaneously $n_{\text{group}} = 1$

Maximum number of all queued pallets $n_{\text{queue}} = 5$

Maximum number of all advancing pallets $n_{\text{queue-1}} = 4$

Spring travel of the pallet buffer $s_F = 1 \text{ mm}$

Selection: stopper cylinder STAF-80-30-P-A-R

1. Checking the permissible load of the first pallet

The maximum permissible load at a conveyor speed of 10 m/min is 150 kg. This means that a total load of 40 kg for the pallet and the workpiece is permissible.

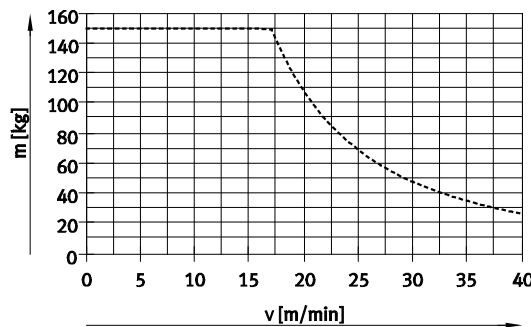

..... STAF-80-...-P-A-R

2a. Calculation of the maximum permissible impact force when pallets collide with a pallet resting against the stopper cylinder

For STAF-80, the maximum permissible impact force is 14,600 N.

This means that with a total force of 1300 N, the number of pallets is permissible.

Impact force calculation:

$$F_{\text{Stoß}} = \frac{(n_{\text{Gruppe}} \cdot m) \cdot v^2}{s_F} = \frac{(1 \cdot 40 \text{ kg}) \cdot (10 \frac{\text{m}}{60 \text{ s}})^2}{0,001 \text{ m}} = \text{ca. } 1100 \text{ N}$$

Frictional force:

$$F_{\text{Reib}} = \mu \cdot (n_{\text{Ansteh}} \cdot m) \cdot g = 0,1 \cdot (5 \cdot 40 \text{ kg}) \cdot 9,81 \frac{\text{m}}{\text{s}^2} = \text{ca. } 200 \text{ N}$$

Max. total force:

$$F_{\text{ges}} = F_{\text{Stoß}} + F_{\text{Reib}} = 1100 \text{ N} + 200 \text{ N} = 1300 \text{ N}$$

Data sheet

Selection aid

2b. Checking the permissible lateral force during the switching operation

Lateral force $F_Q =$ frictional force F_{friction}
 $F_{\text{friction}} = 200 \text{ N}$

The maximum permissible lateral force at an operating pressure of 6 bar is 4500 N.
 This means that a lateral force of 200 N is permissible.

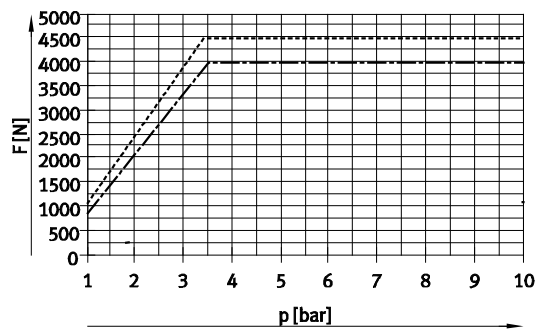

..... STAF-80-30-P-A-R
 - . - . - STAF-80-40-P-A-R

3. Separating and advancing the pallets

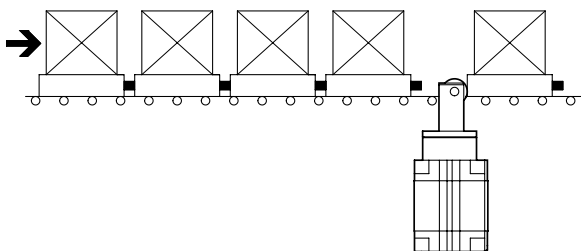

For the STAF-80-30-P-A-R, the maximum permissible load at a conveyor speed of 10 m/min is 150 kg.
 The total mass of the 4 pallets advancing on the stopper cylinder is 160 kg.

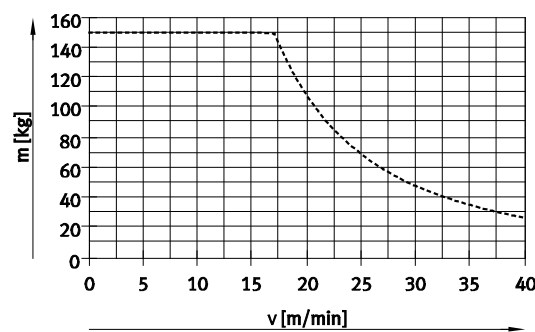

..... STAF-80-...-P-A-R

Max. total mass:

$$m_{\text{Ges}} = n_{\text{Ansteh-1}} \cdot m = 4 \cdot 40 \text{ kg} = 160 \text{ kg}$$

Result

When using the stopper cylinder STAF-80-30-P-A-R, max. 2 advancing pallets may accumulate simultaneously.

Max. total mass:









$$m_{\text{Ges}} = n_{\text{Ansteh-1}} \cdot m = 2 \cdot 40 \text{ kg} = 80 \text{ kg}$$

Data sheet

Application example



Accessories

Ordering data – Proximity switch for T-slot, magneto-resistive						Data sheets → Internet: smt
	Type of mounting	Switching output	Electrical connection	Cable length [m]	Part no.	Type
N/O						
	Inserted in the slot from above, flush with the cylinder profile, short design	PNP	Cable, 3-wire	2.5	574335	SMT-8M-A-PS-24V-E-2.5-OE
			Plug M8x1, 3-pin	0.3	574334	SMT-8M-A-PS-24V-E-0.3-M8D
			Plug M12x1, 3-pin	0.3	574337	SMT-8M-A-PS-24V-E-0.3-M12
		NPN	Cable, 3-wire	2.5	574338	SMT-8M-A-NS-24V-E-2.5-OE
			Plug M8x1, 3-pin	0.3	574339	SMT-8M-A-NS-24V-E-0.3-M8D
N/C						
	Inserted in the slot from above, flush with the cylinder profile, short design	PNP	Cable, 3-wire	7.5	574340	SMT-8M-A-PO-24V-E-7.5-OE
Ordering data – Proximity switches for T-slot, magnetic reed						Data sheets → Internet: sme
	Type of mounting	Switching output	Electrical connection	Cable length [m]	Part no.	Type
N/O						
	Inserted in the slot from above, flush with the cylinder profile	Contacting	Cable, 3-wire	2.5	543862	SME-8M-DS-24V-K-2.5-OE
				5.0	543863	SME-8M-DS-24V-K-5.0-OE
			Cable, 2-wire	2.5	543872	SME-8M-ZS-24V-K-2.5-OE
			Plug M8x1, 3-pin	0.3	543861	SME-8M-DS-24V-K-0.3-M8D
	Inserted in the slot lengthwise, flush with the cylinder profile	Contacting	Cable, 3-wire	2.5	150855	SME-8-K-LED-24
			Plug M8x1, 3-pin	0.3	150857	SME-8-S-LED-24
N/C						
	Inserted in the slot lengthwise, flush with the cylinder profile	Contacting	Cable, 3-wire	7.5	160251	SME-8-O-K-LED-24
Ordering data – Connecting cables						Data sheets → Internet: nebu
	Electrical connection, left	Electrical connection, right	Cable length [m]	Part no.	Type	
	Straight socket, M8x1, 3-pin	Cable, open end, 3-wire	2.5	541333	NEBU-M8G3-K-2.5-LE3	
			5	541334	NEBU-M8G3-K-5-LE3	
	Angled socket, M8x1, 3-pin	Cable, open end, 3-wire	2.5	541338	NEBU-M8W3-K-2.5-LE3	
			5	541341	NEBU-M8W3-K-5-LE3	
Ordering data – Slot cover for T-slot						
	Mounting	Length [m]	Part no.	Type		
	Insertable	2x 0.5	151680	ABP-5-S		