

Connecting cables NEBS, for sensors

FESTO



Product range overview

Function	Design	Type	Connection technology (Electrical connection 2)	Cable characteristic	Length	→ Page/ Internet
Connecting cable	Electrical connection 1: socket, rectangular design L1 (circuit board connector)					
	4-pin	NEBS-L1G4	Plug M12, 4-pin Open cable end	Standard	1 m 2.5 m 5 m	4
	Electrical connection 1: socket M12					
	5-pin	NEBS-M12G5	Open cable end	Suitable for energy chains	5 m 10 m 15 m	8
	12-pin	NEBS-M12G12	Socket M12, 12-pin Open cable end	Basic	0.5 m 2 m 5 m 10 m	10
	Electrical connection 1: plug M12					
	12-pin	NEBS-SM12G12	Plug M12, 12-pin Open cable end	Suitable for energy chains	0.3 m 0.5 m 5 m	13

Type codes

001	Series	
NEBS	Connecting cable for sensors	
002	Connection technology left, field device side	
M12	Socket M12x1 A-coded, EN 61076-2-101	
SM12	Plug M12x1 A-coded	
SM16	Plug M16	
L1	PCB plug connector	
003	Cable outlet left	
G	Straight	
004	Number of pins/wires on the left	
4	4	
5	5	
12	12	
24	24	
005	Cable characteristic	
K	Standard	
E	Suitable for energy chains	
006	Cable design	
	Standard	
S	With shielding	

007	Cable length [m]	
0.3	0.3	
0.5	0.5	
1	1	
2	2	
2.5	2.5	
5	5	
10	10	
15	15	
008	Cable identification	
	With label holder	
N	Without label holder	
009	Connection technology right, controller side	
M12	Plug M12x1 A-coded, EN 61076-2-101	
SM12	Socket, M12, A-coded	
LE	Open end	
010	Plug/socket	
	None	
G	Straight	
011	Number of pins/wires on the right	
4	4	
5	5	
12	12	
24	24	

Data sheet

Connecting cable NEBS-L1G4

- Pre-assembled at one or both ends
- Cable lengths 1 m, 2.5 m and 5 m
- 4 wires
- Socket, rectangular design L1

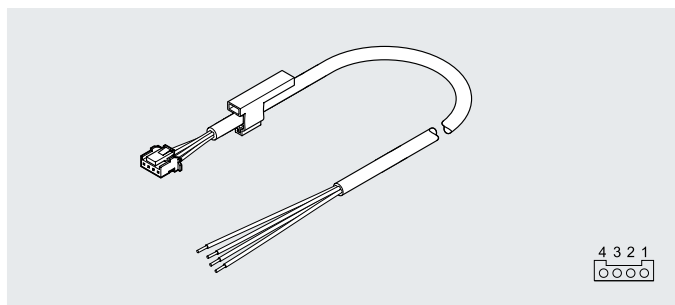

General technical data		
Type	NEBS-...-M12G4	NEBS-...-LE4
Cable designation	Without inscription label holder	With inscription label holder
Contact durability	100	100

Technical data – Electrical connection 1		
Type	NEBS-...-M12G4	NEBS-...-LE4
Function	Field device side	Field device side
Connection type	Socket	Socket
Cable outlet	Straight	Straight
Design	Angular	Angular
Connection technology	Plug pattern L1J	Plug pattern L1J
Number of pins/wires	4	4
Assigned pins/wires	4	4
Type of mounting	Snap-locking	Snap-locking

Technical data – Electrical connection 2		
Type	NEBS-...-M12G4	NEBS-...-LE4
Function	Controller side	Controller side
Connection type	Plug	Cable
Cable outlet	Straight	–
Design	Round	–
Connection technology	M12x1, A-coded to EN 61076-2-101	Open end
Wire ends	–	Cut off bluntly
Number of pins/wires	4	4
Assigned pins/wires	4	4
Type of mounting	Screw-type lock with hex A/F 13 mm and longitudinal knurl	–

Technical data – Electrical properties		
Operating voltage range	[V DC]	0 ... 30
Surge resistance	[kV]	0.8
Current rating at 40°C	[A]	1
Pollution degree		2

Data sheet

Technical data – Cable			
Type		NEBS-...-M12G4	NEBS-...-LE4
Cable diameter	[mm]	4.5	4.1
Cable diameter tolerance	[mm]	±0.1	±0.2
Cable characteristic		Standard	Standard
Cable test conditions		Test conditions on request	Test conditions on request
Bending radius, fixed cable installation	[mm]	≥14	≥13
Bending radius, flexible cable installation	[mm]	≥46	≥42
Cable composition	[mm ²]	4x0.25	4x0.17
Conductor nominal cross section	[mm ²]	0.25	0.17

Materials			
Type		NEBS-...-M12G4	NEBS-...-LE4
Housing		PA	PA
		TPE-U(PUR)	
Housing colour		Black	White
		White	
Screw-type lock		Nickel-plated brass	–
Pin contacts		Tin-plated bronze	Tin-plated bronze
		Gold-plated brass	–
Cable sheath		TPE-U(PUR)	PVC
Cable sheath colour		Grey	Grey
Insulating sheath		PP	PVC
Note on materials		RoHS-compliant	RoHS-compliant
		Halogen-free	–
PWIS conformity		VDMA24364-B2-L	–

Operating and environmental conditions			
Type		NEBS-...-M12G4	NEBS-...-LE4
Ambient temperature	[°C]	–20 ... +60	–20 ... +60
Ambient temperature with flexible cable installation	[°C]	–5 ... +60	–5 ... +60
Storage temperature	[°C]	–20 ... +60	–20 ... +60
Corrosion resistance class CRC ¹⁾		2	4
CE marking (see declaration of conformity) ²⁾		To EU RoHS Directive	To EU RoHS Directive
UKCA marking (see declaration of conformity) ²⁾		To UK RoHS instructions	To UK RoHS instructions
Degree of protection		IP65	IP40
		IP67	
		IP69K	
Note on degree of protection		When mounted	When mounted
		IP40 for plug pattern L1]	

1) Additional information: www.festo.com/x/topic/kbk2) Additional information: www.festo.com/catalogue/... → Support/Downloads.

Connecting cables, socket, rectangular design L1, 4-pin

Data sheet

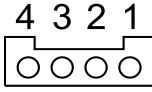
Circuitry (socket view)		Pin	Wire colour ¹⁾	Pin	Electrical connection 2
Electrical connection 1					
Electrical connection, socket, rectangular design L1 – open cable end					
	1		BN	-	-
	2		BK	-	-
	3		WH	-	-
	4		BU	-	-

1) To IEC 757

Dimensions Download CAD data → www.festo.com

Electrical connection, socket, rectangular design L1 – plug M12x1, A-coded

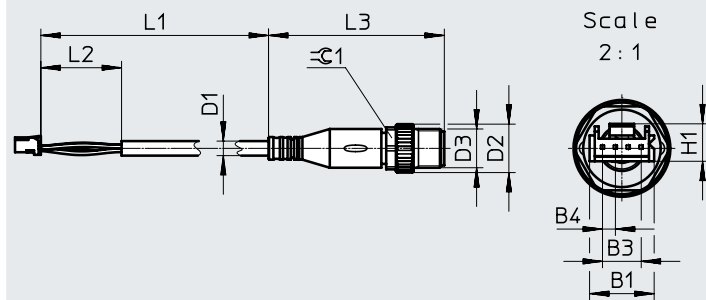

Type	B1	B3	B4	D1 ∅	D2 ∅	D3	H1	L1	L2	L3	⊕
NEBS-L1G4-K-1-N-M12G4	10	6	2	4.5	15	M12x1	5.8	1000	25	54.5	13

Electrical connection, socket, rectangular design L1 – open cable end

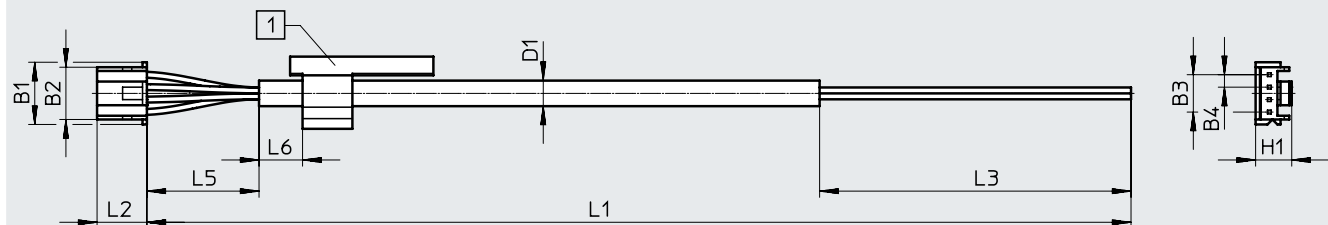

[1] Inscription label holder

Type	B1	B2	B3	B4	D1 ∅	H1	L1	L2	L3	L5	L6
NEBS-L1G4-K-2.5-LE4	10	8.4	6	2	4.1	5.8	2500	8	50	35	≥ 5
NEBS-L1G4-K-5-LE4							5000				

Data sheet

Ordering data				Cable length [m]	Weight [g]	Part no.	Type
Electrical connection		Connection 2					
Connection 1		Connection 2					
Socket, rectangular design L1	4-pin	Plug M12x1, A-coded	4-pin	1	40	8091514	NEBS-L1G4-K-1-N-M12G4
		Open end	4-wire	2.5	53	572576	NEBS-L1G4-K-2.5-LE4
				5	106	572577	NEBS-L1G4-K-5-LE4

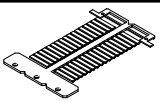
Ordering data – Accessories					
	Use	Size	Part no.	Type	pU ¹⁾
	Inscription label for insertion in label holder	23x4 mm	541598	ASLR-L-423	30

1) Packaging unit

Data sheet

Connecting cable NEBS-M12G5

- Pre-assembled at one end
- Cable lengths 5 m, 10 m and 15 m
- 5 wires
- Socket M12x1

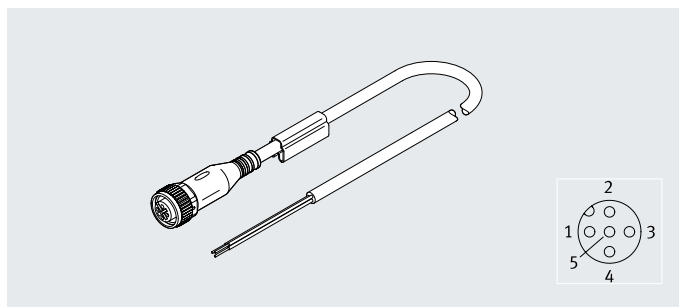

General technical data

Cable designation	With 2x inscription label holders
-------------------	-----------------------------------

Technical data – Electrical connection 1

Function	Field device side
Design	Round
Connection type	Socket
Cable outlet	Straight
Connection technology	M12x1, A-coded to EN 61076-2-101
Number of pins/wires	5
Assigned pins/wires	5
Type of mounting	Screw-type lock

Technical data – Electrical connection 2

Function	Controller side
Connection type	Cable
Connection technology	Open end
Wire ends	Cut off bluntly
Number of pins/wires	5
Assigned pins/wires	5

Technical data – Electrical properties

Operating voltage range	[V DC]	0 ... 60
	[V AC]	0 ... 48
Surge resistance	[kV]	1.5
Current rating at 40°C	[A]	4
Screening		Yes
Pollution degree		3

Technical data – Cable

Cable diameter	[mm]	5.25
Cable diameter tolerance	[mm]	±0.2
Cable composition	[mm ²]	5x0.34
		Shielded
Conductor nominal cross section	[mm ²]	0.34
Cable characteristic		Suitable for energy chains
Cable test conditions		Test conditions on request
Bending radius, fixed cable installation	[mm]	≥26
Bending radius, flexible cable installation	[mm]	≥52

Data sheet

Materials	
Seals	NBR
Pin contacts	Nickel-plated and gold-plated bronze
Cable sheath	TPE-U(PUR)
Cable sheath colour	Black
Insulating sheath	PP
Note on materials	RoHS-compliant
PWIS conformity	VDMA24364-B2-L

Operating and environmental conditions	
Ambient temperature [°C]	-40 ... +80
Ambient temperature with flexible cable installation [°C]	-25 ... +60
CE marking (see declaration of conformity) ¹⁾	To EU RoHS Directive
UKCA marking (see declaration of conformity) ¹⁾	To UK RoHS instructions
Degree of protection	IP65
	IP67
Note on degree of protection	When mounted

1) Additional information: www.festo.com/catalogue/... → Support/Downloads.

Circuitry (socket view)			
Electrical connection 1	Pin	Wire colour ¹⁾	Electrical connection 2
	1	BN	-
	2	WH	-
	3	BU	-
	4	BK	-
	5	GY	-

1) To IEC 757

Dimensions Download CAD data → www.festo.com

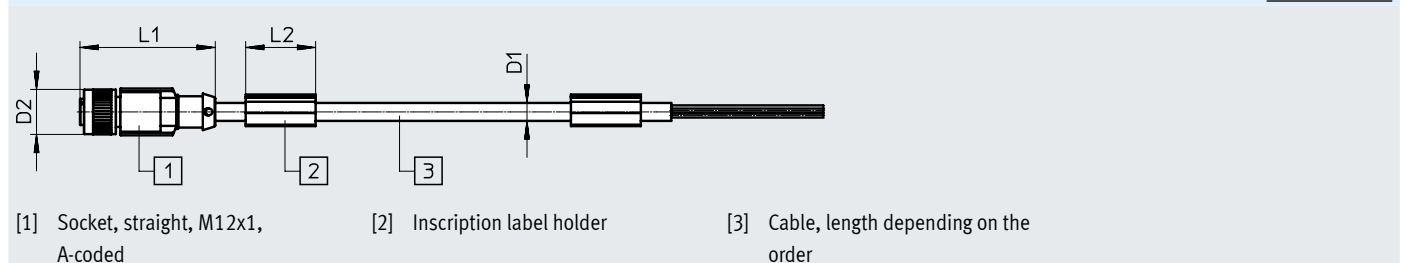

Type	D1 ∅	D2 ∅	L1	L2
NEBS-M12G5-ES-5-LE5	5.25	14.8	44.5	22
NEBS-M12G5-ES-10-LE5				
NEBS-M12G5-ES-15-LE5				

Ordering data				Cable length [m]	Weight [g]	Part no.	Type
Electrical connection		Connection 2					
Connection 1		Connection 2					
Socket, straight design	5-pin	Open end	5-wire	5	276	8030962	NEBS-M12G5-ES-5-LE5
				10	528	8030963	NEBS-M12G5-ES-10-LE5
				15	828	8097576	NEBS-M12G5-ES-15-LE5

Data sheet

Connecting cable NEBS-M12G12

- Pre-assembled at one or both ends
- Cable lengths 0.5 m, 2 m, 5 m and 10 m
- 12 wires
- Socket M12x1

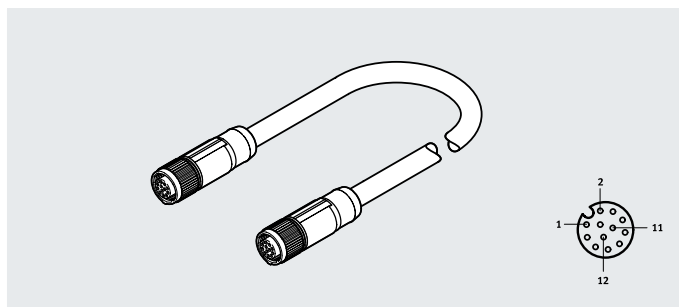

General technical data

Cable designation	With inscription label holder
-------------------	-------------------------------

Technical data – Electrical connection 1

Connection type	Socket
Cable outlet	Straight
Connection technology	M12x1, A-coded
Number of pins/wires	12

Technical data – Electrical connection 2

Connection type	Socket	Cable
Cable outlet	Straight	–
Connection technology	M12x1, A-coded	Open end
Number of pins/wires	12	12

Technical data – Electrical properties

Electrical connection 2	Socket, M12x1, A-coded	Cable, open end
Nominal operating voltage [V DC]	30	30
Operating voltage range [V DC]	0 ... 30	0 ... 30
Surge resistance [kV]	0.8	0.8
Current rating at 40°C [A]	1.5	1.5
Pollution degree	3	3

Technical data – Cable

Cable diameter [mm]	8.5
Cable diameter tolerance [mm]	±0.2
Cable composition [mm ²]	12x0.14
	Shielded
Conductor nominal cross section [mm ²]	0.14
Cable characteristic	Basic
Minimum cable bending radius [mm]	85
Bending radius, fixed cable installation [mm]	42.5
Cable test conditions	Bending strength: to Festo standard

Materials

Screw-type lock	Die-cast zinc
Seals	NBR
Pin contacts	Nickel-plated and gold-plated brass
Cable sheath	TPE-U(PUR)
Cable sheath colour	Black
Note on materials	RoHS-compliant
PWIS conformity	VDMA24364-B2-L

Data sheet

Operating and environmental conditions		
Ambient temperature	[°C]	-30 ... +80
Ambient temperature with flexible cable installation	[°C]	-25 ... +80
CE marking (see declaration of conformity) ²⁾		To EU RoHS Directive
UKCA marking (see declaration of conformity) ²⁾		To UK RoHS instructions
Degree of protection		IP67
Corrosion resistance class CRC ¹⁾		0

- 1) Additional information: www.festo.com/x/topic/kbk
 2) Additional information: www.festo.com/catalogue/... → Support/Downloads.

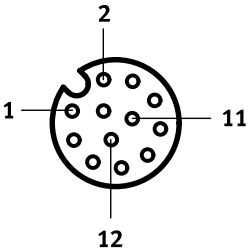
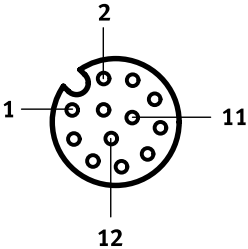
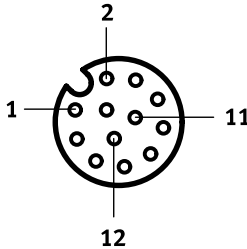
Circuitry (socket view)				
Electrical connection 1	Pin	Wire colour ¹⁾	Pin	Electrical connection 2
Electrical connection, socket M12x1, 12-pin – open cable end				
	1	BN	-	-
	2	BU	-	-
	3	WH	-	-
	4	GN	-	-
	5	PK	-	-
	6	YE	-	-
	7	BK	-	-
	8	GY	-	-
	9	RD	-	-
	10	VT	-	-
	11	GY PK	-	-
	12	RD BU	-	-
Electrical connection, socket M12x1, 12-pin – socket M12x1, 12-pin				
	1	BN	1	
	2	BU	2	
	3	WH	3	
	4	GN	4	
	5	PK	5	
	6	YE	6	
	7	BK	7	
	8	GY	8	
	9	RD	9	
	10	VT	10	
	11	GY PK	11	
	12	RD BU	12	

1) To IEC 757

Data sheet

Dimensions

Download CAD data → www.festo.com

Electrical connection, socket M12x1, 12-pin – socket M12x1, 12-pin

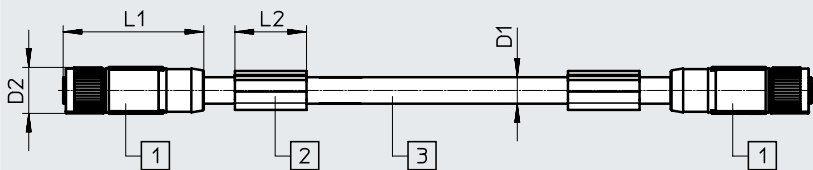

- [1] Socket, straight, M12x1, A-coded
- [2] Inscription label holder
- [3] Cable, length depending on the order

Type	D1 ∅	D2 ∅	L1	L2
NEBS-M12G12-KS-0.5-SM12G12	8.5	14.8	45.2	22
NEBS-M12G12-KS-2-SM12G12				

Electrical connection, socket M12x1, 12-pin – open cable end

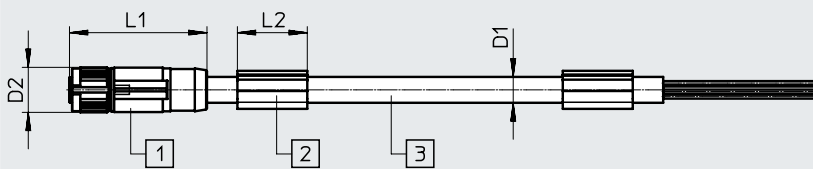

- [1] Socket, straight, M12x1, A-coded
- [2] Inscription label holder
- [3] Cable, length depending on the order

Type	D1 ∅	D2 ∅	L1	L2
NEBS-M12G12-KS-5-LE12	8.5	14.8	45.2	22
NEBS-M12G12-KS-10-LE12				

Ordering data

Electrical connection				Cable length [m]	Weight [g]	Part no.	Type
Connection 1		Connection 2					
Socket, straight design	12-pin	Socket, straight design	12-pin	0.5	87	3056124	NEBS-M12G12-KS-0.5-SM12G12
			12-pin	2	223	3058527	NEBS-M12G12-KS-2-SM12G12
	Open end	12-wire	5	492	3058614	NEBS-M12G12-KS-5-LE12	
			10	945	2912452	NEBS-M12G12-KS-10-LE12	

Data sheet

Connecting cable
NEBS-SM12G12

- Pre-assembled at one or both ends
- Cable lengths 0.3 m, 0.5 m and 5 m
- 12 wires
- Plug M12x1

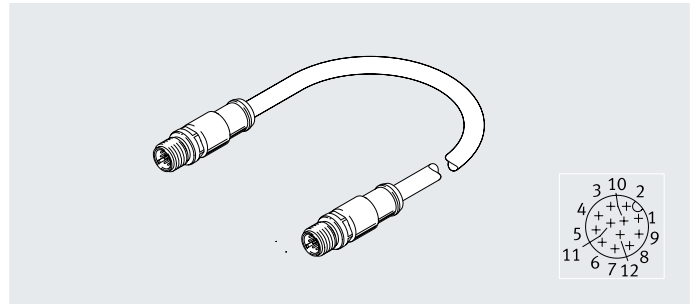

General technical data

Conforms to standard	EN 61076-2-101
Cable designation	With accessories

Technical data – Electrical connection 1

Function	Field device side
Connection type	Plug
Cable outlet	Straight
Design	Round
Connection technology	M12x1, A-coded to EN 61076-2-101
Number of pins/wires	12
Assigned pins/wires	12
Type of mounting	Screw-type lock with hexagon A/F 13 mm

Technical data – Electrical connection 2

Function	Controller side	Controller side
Connection type	Plug	Cable
Cable outlet	Straight	–
Design	Round	–
Connection technology	M12x1, A-coded to EN 61076-2-101	Open end
Wire ends	–	Cut off bluntly
Number of pins/wires	12	12
Assigned pins/wires	12	12
Type of mounting	Screw-type lock with hexagon A/F 13 mm	–

Technical data – Electrical properties

Operating voltage range	[V DC]	0 ... 30
	[V AC]	0 ... 30
Surge resistance	[kV]	0.5
Current rating at 40°C	[A]	1.5
Pollution degree		3
Contact durability		100

Data sheet

Technical data – Cable		
Cable diameter	[mm]	6.5
Cable composition	[mm ²]	12x0.25
Conductor nominal cross section	[mm ²]	0.25
Cable characteristic		Suitable for energy chains
Bending radius, fixed cable installation	[mm]	≥32
Bending radius, flexible cable installation	[mm]	≥65
Cable test conditions		Test conditions on request

Materials	
Housing	TPE-U(PUR)
Housing colour	Black
Screw-type lock	Nickel-plated, die-cast zinc
Pin contacts	Gold-plated brass
Cable sheath	TPE-U(PUR)
Cable sheath colour	Black
Note on materials	RoHS-compliant

Operating and environmental conditions		
Ambient temperature	[°C]	-5 ... +70
Ambient temperature with flexible cable installation	[°C]	-5 ... +70
Degree of protection		IP67
Note on degree of protection		When mounted
Corrosion resistance class CRC ¹⁾		1
CE marking (see declaration of conformity) ²⁾		To EU RoHS Directive
UKCA marking (see declaration of conformity) ²⁾		To UK RoHS instructions
PWIS conformity		VDMA24364-B2-L

1) Additional information: www.festo.com/x/topic/kbk

2) Additional information: www.festo.com/catalogue/... → Support/Downloads.

Data sheet

Circuitry (plug view)		Electrical connection 1		Pin	Wire colour ¹⁾	Pin	Electrical connection 2
Electrical connection, plug M12x1, 12-pin – open cable end							
	1		BN	-	-		
	2		BU	-			
	3		WH	-			
	4		GN	-			
	5		PK	-			
	6		YE	-			
	7		BK	-			
	8		GY	-			
	9		RD	-			
	10		VT	-			
	11		GY PK	-			
	12		RD BU	-			
Electrical connection, plug M12x1, 12-pin – plug M12x1, 12-pin							
	1		BN	1			
	2		BU	2			
	3		WH	3			
	4		GN	4			
	5		PK	5			
	6		YE	6			
	7		BK	7			
	8		GY	8			
	9		RD	9			
	10		VT	10			
	11		GY PK	11			
	12		RD BU	12			

1) To IEC 757

Data sheet

Dimensions

Download CAD data → www.festo.com

Electrical connection, plug M12x1, 12-pin – socket M12x1, 12-pin

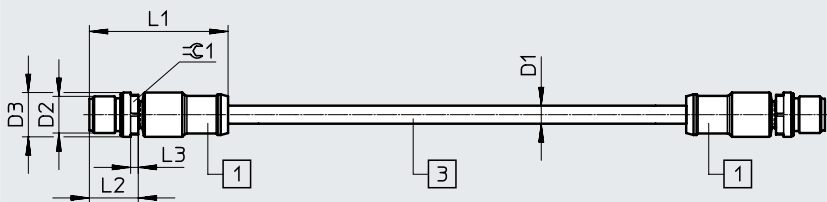

- [1] Plug, straight, 12-pin, M12x1, A-coded
- [3] Cable, length depending on the order

Type	D1 ∅	D2	D3 ∅	L1	L2	L3	∅ 1
NEBS-SM12G12-E-0.3-N-M12G12	6.5	M12x1	14.5	45.4	16	2.5	13

Electrical connection, plug M12x1, 12-pin – open cable end

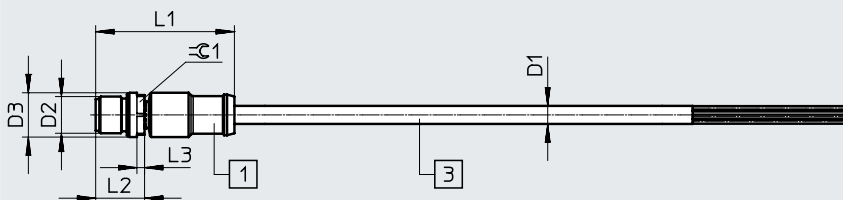

- [1] Plug, straight, 12-pin, M12x1, A-coded
- [3] Cable, length depending on the order

Type	D1 ∅	D2	D3 ∅	L1	L2	L3	∅ 1
NEBS-SM12G12-E-0.5-N-LE12	6.5	M12x1	14.5	45.4	16	2.5	13
NEBS-SM12G12-E-5-N-LE12							

Ordering data

Electrical connection		Cable length [m]	Part no.	Type		
Connection 1	Connection 2					
Plug, straight design	12-pin	Plug, straight design	12-pin	0.3	3947404	NEBS-SM12G12-E-0.3-N-M12G12
		Open end	12-wire	0.5	3947401	NEBS-SM12G12-E-0.5-N-LE12
	5			3947395	NEBS-SM12G12-E-5-N-LE12	

Ordering data – Accessories

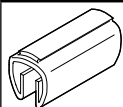
			Part no.	Type
	Inscription labels for attachment to a cable with diameter 5 ... 8 mm	11x20 mm	33361	KM-BZ