

## Solenoid valves, to NAMUR

**FESTO**

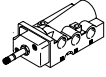

Product range overview

Function	Design	Type	Nominal width [mm]	Standard nominal flow rate [l/min]	Pneumatic connection	Operating pressure [bar]	Ambient temperature [°C]
5/2-way valves <sup>1)</sup>		NVF3-...-EX	7	900	G 1/4	2 ... 10	-5 ... +40
							ATEX: -5°C . = Ta . = +40°C
							ATEX: -5°C . = Ta . = +40°C

1) Can be converted to 3/2-way function by turning the sealing plate

## Product range overview

Type	Solenoid coil	Operating voltage range		Type of ignition protection			→ Page
		[V DC]	[V AC]	nA = Non-sparking	m = Encapsulation	ia = Intrinsically safe	
NVF3-...-EX	MSFG-...-OD <sup>1)</sup> MSFW-...-OD <sup>1)</sup>	12, 24, 42, 48	24, 42, 48, 110, 230, 240	–	–	–	6
	MSFG-...-EX <sup>1)</sup> MSFW-...-EX <sup>1)</sup>	24	24, 110, 230	■	–	–	
	MSFG-...-M-EX <sup>1)</sup> MSFW-...-M-EX <sup>1)</sup>	24	24, 110, 230	–	■	–	

1) Solenoid coil must be ordered separately

Peripherals overview

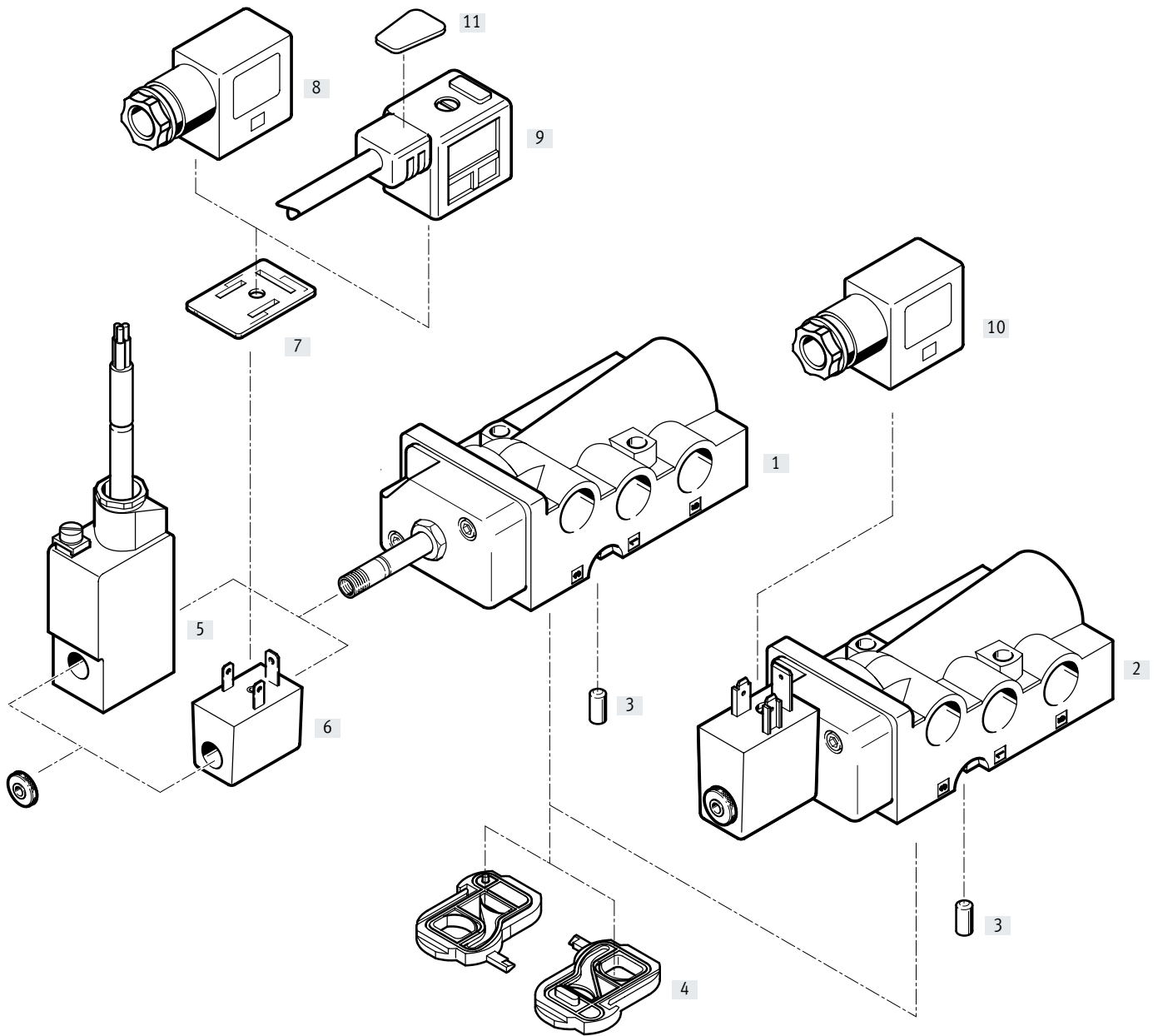

## Peripherals overview

Solenoid valves and accessories		Brief description	→ Page
<b>Solenoid valves</b>			
[1]	NVF3-MOH-5/2K-1/4-EX	Solenoid valve for F solenoid coil	6
[2]	NVF3-MOH-5/2K-1/4-IA-EX	Solenoid valve mounted with intrinsically safe solenoid coil, ignition protection type ia = intrinsically safe	
<b>Accessories</b>			
[3]	Coding pin	Included in the scope of delivery	–
[4]	Sealing plate	For changing the valve function, included in the scope of delivery	–
[5]	Solenoid coil MSFG-...-M-EX and MSFW-...-M-EX	Ignition protection type m = encapsulation	10
[6]	Solenoid coil MSFG-...-EX and MSFW-...-EX	Ignition protection type nA = non-sparking	
[7]	Illuminating seal MF-LD	For indicating the switching status	
[8]	Plug socket MSSD-F-M16	Insert can be repositioned by 180°. Ignition protection type nA = non-sparking for solenoid coils in position [6]	
[9]	Plug socket with cable KMF	Insert can be repositioned by 180°	
[10]	Plug socket MSSD-V-M16	Insert can be repositioned by 180°. Ignition protection type ia = intrinsically safe for solenoid coil in position [2]	
[11]	Inscription labels KMC/F/V-BZ	For identifying the plug sockets	

## Data sheet

Function<sup>1)</sup>

5/2-way valve

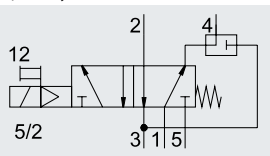

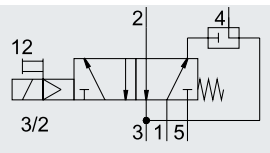

3/2-way valve

with exhaust return



-  - Voltage  
12, 24, 42, 48 V DC  
24, 42, 48, 110, 230,  
240 V AC

-  - Pressure  
2 ... 10 bar

-  - Temperature range  
-5 ... +40°C  
ATEX  
-5°C . = Ta . = +40°C

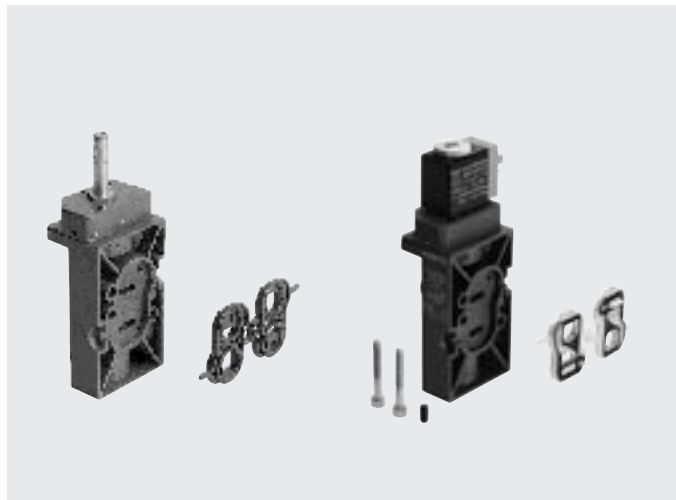

<sup>1)</sup> Can be changed by turning the sealing plate

General technical data		Solenoid valve with F coil of choice
Valve function		5/2-way or 3/2-way, single solenoid
Conforms to standard		VDI/VDE 3845 (NAMUR)
Width	[mm]	53
Design		Poppet seat
Sealing principle		Soft
Actuation type		Electrical
Reset method		Mechanical spring
Type of control		Piloted
Flow direction		Not reversible
Exhaust function		Can be throttled
Manual override		Detenting, non-detenting
Type of mounting		On manifold rail
Mounting position		Any
Non-overlapping		No
Port for venting hole		Internal
Nominal width	[mm]	7
Overlap		Negative overlap
Standard nominal flow rate	1 → 2, 2 → 3 [l/min]	900
	Exhaust return 2 → 4 [l/min]	150
b value		0.33
C value	[l/sbar]	4.2
Pneumatic connection	1, 3, 5	G 1/4
	2, 4	Plug pattern as per NAMUR
	Pilot exhaust port 84	M5
Product weight	[g]	280

## Data sheet

Operating and environmental conditions		Solenoid valve with F coil of choice
Operating medium		Compressed air to ISO 8573-1:2010 [7:4:4]
Note on the operating/pilot medium		Lubricated operation possible (in which case lubricated operation will always be required)
Operating pressure	[bar]	2 ... 10
	[MPa]	0.2 ... 1
Ambient temperature	[°C]	-5 ... +40
Temperature of medium	[°C]	-5 ... +40
ATEX category for gas		II 2G
Type of ignition protection for gas		Ex h IIC T6 Gb
ATEX category for dust		II 2D
Type of ignition protection for dust	[°C]	Ex h IIIC T70° C Db
Explosion-proof ambient temperature		-5°C ≤ Ta ≤ +40°C
Explosion protection certification outside the EU		EPL Db (GB)
		EPL Gb (GB)
CE marking		To EU Explosion Protection Directive (ATEX)
UKCA marking (see declaration of conformity)		To UK EX instructions
Corrosion resistance class CRC <sup>1)</sup>		1

1) Corrosion resistance class CRC 1 to Festo standard FN 940070

Low corrosion stress. Dry indoor application or transport and storage protection. Also applies to parts behind coverings, in the non-visible interior area, and parts which are covered in the application (e.g. drive trunnions).

Electrical data		Solenoid valve with F coil of choice
Electrical connection		Plug, 3-pin or cable, 3-wire
Operating voltage range	[V DC]	12, 24, 42, 48
	[V AC]	24, 42, 48, 110, 230, 240 at 50 ... 60 Hz
Coil characteristics, 24 V DC	[W]	-
Max. input power	[W]	-
Max. input voltage	[V]	-
Max. input current	[A]	-
Effective inductance		-
Effective capacitance		-
Degree of protection to EN 60529		IP65 with plug socket
Switching time on	[ms]	50
Switching time off	[ms]	100

Data sheet

Materials

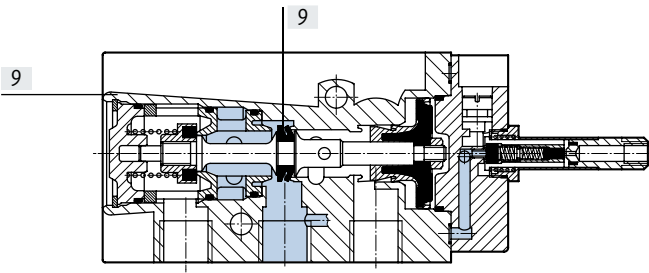

[1]	Housing	Die-cast aluminium
[2]	Seals	NBR

Sample circuit

5/2-way valve

3/2-way valve with the option of exhaust return

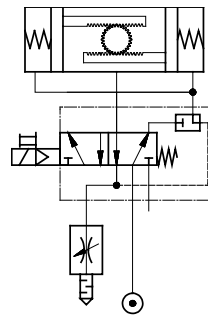
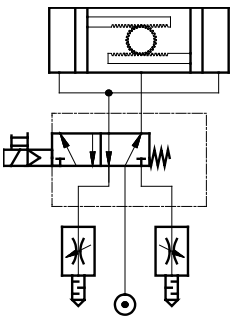



Data sheet

Dimensions

Download CAD data → [www.festo.com](http://www.festo.com)

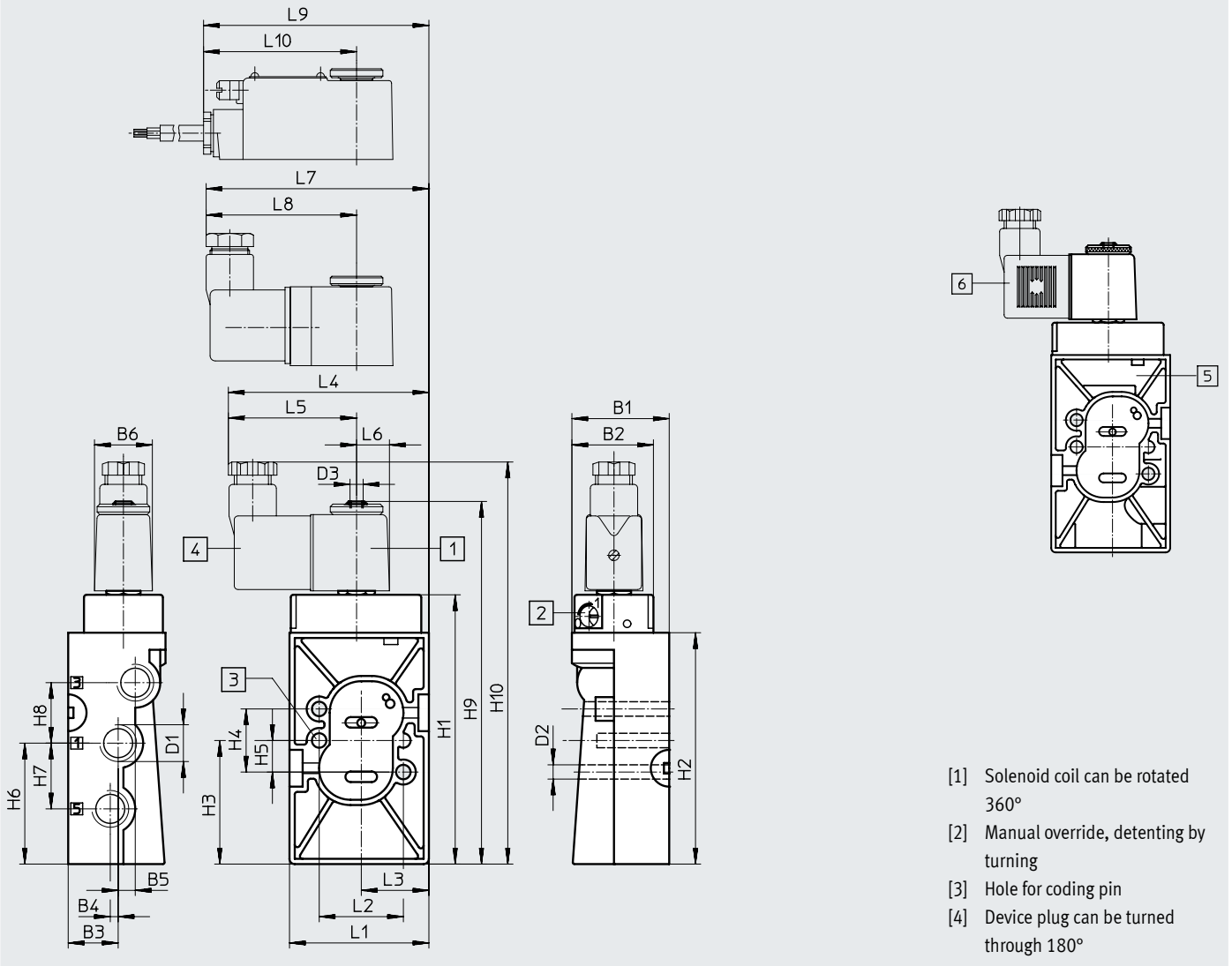

Type	B1	B2	B3 ±0.1	B4 ±0.1	B5 ±0.1	B6	D1	D2 ∅	D3	H1	H2	H3 ±0.15	H4 ±0.15	H5 ±0.1	H6 ±0.1
NVF3-...	37	31	19	3	6.5	22	G 1/4	5.5	M5	102.4	88	47	24	12	46





Type	H7 ±0.15	H8 ±0.15	H9	H10	L1 ±0.2	L2 ±0.15	L3 ±0.1	L4	L5	L6	L7	L8	L9	L10
NVF3-...	25	23	136.4	153	53	32	27.7	76.5	49	12.5	84.7	57.2	85.3	57.8

Ordering data – Valves

		Part no.	Type
	Solenoid valve without solenoid coil <sup>1)</sup>	535987	NVF3-MOH-5/2-K-1/4-Ex

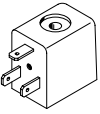
<sup>1)</sup> Solenoid coil must be ordered separately → 10  
 Explosion-proof solenoid coil → 11

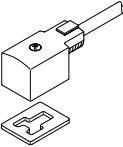
## Accessories

Ordering data		Operating voltage	Cable length	Part no.	Type
<b>Solenoid coil F without plug socket</b>					Data sheets → Internet: msfg, msfw
	12 V DC	–		34410	MSFG-12-OD
	24 V DC	–		34411	MSFG-24/42-50/60-OD
	42 V DC	–		34413	MSFG-42-OD
	24 V AC/50 ... 60 Hz	–		34415	MSFW-24-50/60-OD
	42 V AC/50 ... 60 Hz	–		34411	MSFG-24/42-50/60-OD
	48 V AC/50 ... 60 Hz	–		34418	MSFW-48-50/60-OD
	110 V AC/50 ... 60 Hz	–		34420	MSFW-110-50/60-OD
	230 V AC/50 ... 60 Hz	–		34422	MSFW-230-50/60-OD
240 V AC/50 ... 60 Hz	–		34424	MSFW-240-50/60-OD	
<b>Plug socket with screw terminal technology</b>					Data sheets → Internet: mssd
	–	–		34431	MSSD-F
	–	–		539710	MSSD-F-M16
<b>Plug socket with insulation displacement connection</b>					Data sheets → Internet: mssd
	–	–		192746	MSSD-F-S-M16
<b>Plug socket with cable</b>					Data sheets → Internet: kmf-1
	24 V DC	2.5 m		30935	KMF-1-24DC-2.5-LED
	0 ... 240 V DC/AC			30936	KMF-1-230AC-2.5
	24 V DC	5 m		30937	KMF-1-24DC-5-LED
	0 ... 240 V DC/AC			30938	KMF-1-230AC-5
<b>Illuminating seal</b>					Data sheets → Internet: mf-ld
	12 ... 24 V DC/AC	–		19143	MF-LD-12-24DC
	230 V DC/AC	–		19144	MF-LD-230AC
<b>Inscription label</b>					Data sheets → Internet: kmc/f/v
	–	–		33362	KMC/F/V-BZ-35X <sup>1)</sup>





1) Pack of 35

 **Note**

Valve/solenoid coil combinations made up of basic valve NVF3-MOH-5/2-K-1/4-EX and solenoid coils MSF...-OD must not be used in potentially explosive areas. Only combinations with the approved solenoid coils MSF...-EX may be used here.

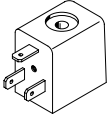
→ 11

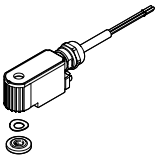
## Accessories for ATEX environment

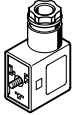
Ordering data		Operating voltage	Cable length	Part no.	Type
<b>Solenoid coil F for ignition protection type nA = non-sparking</b>					Data sheets → Internet: msfw, msfg
 	24 V DC	–	536931	MSFG-24-EX	
	24 V AC/50 ... 60 Hz	–	536932	MSFW-24-50/60-EX	
	110 V AC/50 ... 60 Hz	–	536933	MSFW-110-50/60-EX	
	230 V AC/50 ... 60 Hz	–	536934	MSFW-230-50/60-EX	
<b>Solenoid coil F for ignition protection type mb</b>					Data sheets → Internet: vacf
 	24 V DC	1 m	8059804	VACF-B-K1-1-1-EX4-M	
	24 V DC	5 m	8059805	VACF-B-K1-1-5-EX4-M	
	24 V AC/50 ... 60 Hz	1 m	8059808	VACF-B-K1-1A-1-EX4-M	
	110 V AC/50 ... 60 Hz	1 m	8059811	VACF-B-K1-16B-1-EX4-M	
	110 V AC/50 ... 60 Hz	5 m	8059812	VACF-B-K1-16B-5-EX4-M	
	230 V AC/50 ... 60 Hz	1 m	8059809	VACF-B-K1-3A-1-EX4-M	
	230 V AC/50 ... 60 Hz	5 m	8059810	VACF-B-K1-3A-5-EX4-M	
	24 V DC	x m	8059807	VACF-B-K1-1-20-EX4-M	
<b>Plug socket with screw terminal connection for solenoid valve NVF3-MOH-5/2-K-1/4-IA-EX, ignition protection type ia = intrinsically safe</b>					Data sheets → Internet: mssd
	–	–	539713	MSSD-V-M16	