

## Branching module MS6-FRM

**FESTO**



## Characteristics

### At a glance

- Grid dimension: 62 mm
- Outlet at top and bottom
- Support for additional modules
- Optionally with integrated non-return function and pressure switch
- Can be used as an intermediate distributor for varying air qualities
- Optional pressure sensor

### Product segmentation



#### Festo Core Range

Solves the majority of your automation tasks

With the Festo Core Range, we have selected the most important products and functions from our broad product catalogue, and added the quickest delivery. The Core Range offers you the best value with the expected high Festo quality.

- Quickest delivery, worldwide – wherever, whenever
- Expected high Festo quality
- Easy and fast to select

### Ordering data - modular system

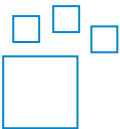

Configurable product

This product and all its product options can be ordered online via the configurator.

### Function

Air distributor with 4 connections

### Pneumatic connection

Depending on the size, different connection types can be selected:

- Individual fittings that are fastened via a female thread
- Connecting plates with female thread

### Additional function

None

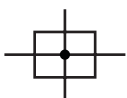

With integrated non-return function

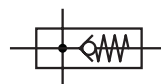

prevents backflow, e.g. of lubricated compressed air

### Pressure gauge alternatives

Two pressure gauge connections for variable installation

### Alternative pressure gauge scale

The scaling of the built-in pressure gauge can be selected. The unit options available are [MPa], [bar] / [psi].

### Pressure switch

Optionally available with different pressure switches.

## Characteristics

### EU certification

Optional device variant EX4 for use in potentially explosive areas of zones 1, 2, 21 and 22

### UL certification

Optional device variant UL1, which meets the safety requirements for the Canadian and US markets.

### Flow direction

Available with flow in the opposite direction.

## Type code

001		Series
MS6		MS-series, size 6
002		Size
6		Grid dimension 62 mm
003		Function
FRM		Branching module
004		Pneumatic connection
1/4		Female thread G1/4
3/8		Female thread G3/8
1/2		Female thread G1/2
AGB		Sub-base G1/4
AGC		Sub-base G3/8
AGD		Sub-base G1/2
AGE		Sub-base G3/4
005		Additional function
		None
I		With integrated non-return function
006		Pressure gauge alternatives
		None
A4		Adapter for EN pressure gauge 1/4, without pressure gauge
A8		Adapter for EN pressure gauge 1/8, without pressure gauge
AD7		Pressure sensor with switching display, M8 plug, threshold value comparator, PNP, N/O
AD8		Pressure sensor with switching display, M8 plug, threshold value comparator, PNP, N/C
AD9		Pressure sensor with switching display, M8 plug, window comparator, PNP, N/O
AD10		Pressure sensor with operational status indicator, M8 plug, window comparator, PNP, N/C
AD11		Pressure sensor with LCD display, M12 plug, 4-pin, IO-Link®, PNP, NPN, 0...10 V, 1...5 V, 4...20 mA
AD12		Pressure sensor with LCD display, M8 plug, 4-pin, IO-Link®, PNP, NPN, 0...10 V, 1...5 V, 4...20 mA
AG		MS pressure gauge
RG		Integrated pressure gauge, red/green scale

007		Alternative pressure gauge scale
		MS pressure gauge
PSI		psi
MPA		MPa
008		Pressure switch
		None
X		Pressure switch PEV with display, plug socket, EN 175301, type A, cube
Y		Pressure switch PEV without display, plug socket, EN 175301, type A, cube
M12		Pressure switch PEV without display, plug socket, round, M12, 4-pin
009		Type of mounting
		Without mounting bracket
WP		Mounting bracket basic design
WPM		Mounting bracket for hooking in service unit components
WB		Mounting centrally at rear (wall mounting top and bottom), connecting plates not required
010		EU certification
		None
EX4		II 2GD
011		UL certification
		None
UL1		cULus ordinary location for Canada and USA
012		Flow direction
		Flow direction from left to right
Z		Flow direction from right to left
013		Special material properties
		None
F1A		Recommended for production plants for manufacturing lithium-ion batteries, F1A

# Datasheet

## General technical data

Pneumatic connection, port 1	G1/4, G3/8, G1/2
Pneumatic connection, port 2	G1/4, G3/8, G1/2
Pneumatic connection, port 3	G1/2
Pneumatic connection, port 4	G1/2
Design	Branching module, With non-return function
Mounting position	optional

## Standard nominal flow rate

Pneumatic connection, port 1	G1/4, G3/8, G1/2
Standard nominal flow rate in main flow direction 1->2	3,200 ... 14,700 l/min
Standard nominal flow rate, outlet upwards	2,700 ... 6,000 l/min
Standard nominal flow rate, outlet downwards	2,800 ... 6,400 l/min

## Electrical data

Operational voltage range AC <sup>1)</sup>	0 ... 250 V
Operational voltage range DC <sup>2)</sup>	0 ... 125 V

1) Only in combination with pressure switch

2) Only in combination with pressure switch

## Operating and environmental conditions

Operating pressure	0 ... 20 bar
Operating medium	Compressed air to ISO 8573-1:2010 [7:4:4], Inert gases
Note on operating and pilot medium	Lubricated operation possible (in which case lubricated operation will always be required)
Ambient temperature	-10 ... 60°C
Media temperature	-10 ... 60°C
Storage temperature	-10 ... 60°C
Corrosion resistance class CRC <sup>1)</sup>	2 - Moderate corrosion stress
Suitable for use with food <sup>2)</sup>	See supplementary material information
Approval <sup>3)</sup>	c UL us - Recognized (OL)
Instructions on use	Foreign particles can adhere to the product or form during installation. Depending on the application, it may be necessary to purge the product with clean compressed air, to clean it after installation and operate it with ducted exhaust air.

1) Corrosion resistance class CRC 2 to Festo standard FN 940070.

Moderate corrosion stress. Indoor applications in which condensation can occur. External visible parts with primarily decorative surface requirements that are in direct contact with a normal industrial environment.

2) More information [www.festo.com/catalogue/ms-fm](http://www.festo.com/catalogue/ms-fm) → Support/Downloads.

3) More information [www.festo.com/catalogue/ms-fm](http://www.festo.com/catalogue/ms-fm) → Support/Downloads.

## ATEX

ATEX category gas	II 2G
Explosion ignition protection type for gas	Ex h IIC T6 Gb X
ATEX category dust	II 2D
Explosion ignition protection type for dust	Ex h IIIC T60°C Db X
Explosion ambient temperature	-10°C ≤ Ta ≤ +60°C
CE mark (see declaration of conformity) <sup>1)</sup>	To EU Explosion Protection Directive (ATEX)

1) More information [www.festo.com/sp/Certificates](http://www.festo.com/sp/Certificates).

## Materials

Material housing	Die-cast aluminium
Note on materials	RoHS-compliant
LABS (PWIS) conformity	VDMA24364-B1/B2-L

## Datasheet

### Additional material properties – products for battery production (F1A)

Suitability for the production of Li-ion batteries	Metals with more than 1% by mass of copper, zinc or nickel by mass are excluded from use. Exceptions are nickel in steel, chemically nickel-plated surfaces, printed circuit boards, cables, electrical plug connectors and coils, Metals with more than 1% by mass of copper, zinc or nickel are excluded from use. Exceptions are nickel in steel, chemically nickel-plated surfaces, printed circuit boards, cables, electrical plug connectors and coils
--	--

## Dimensions

Dimensions – Basic type with female thread, with cover plate

Download CAD data → [www.festo.com](http://www.festo.com)

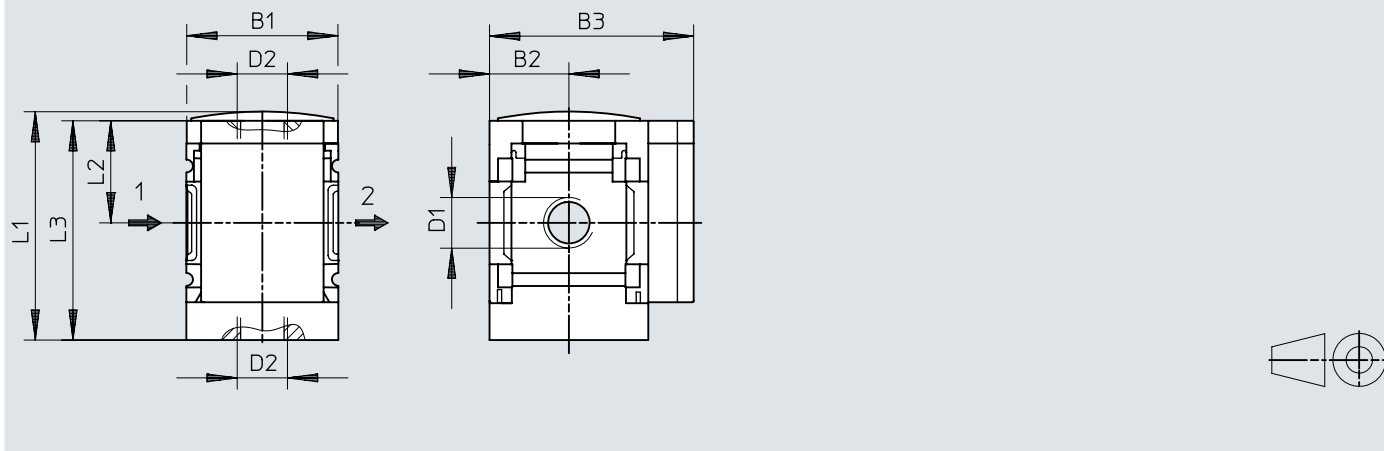

	B1	B2	B3	D1	D2	L1	L2	L3
MS6-FRM-1/4	62	31	76	G1/4	G1/2	87,2	39	84,5
MS6-FRM-3/8				G3/8				
MS6-FRM-1/2				G1/2				

## Dimensions

Dimensions – AG Integrated MS pressure gauge with standard scale, RG integrated MS pressure gauge with red/green scale

Download CAD data → [www.festo.com](http://www.festo.com)

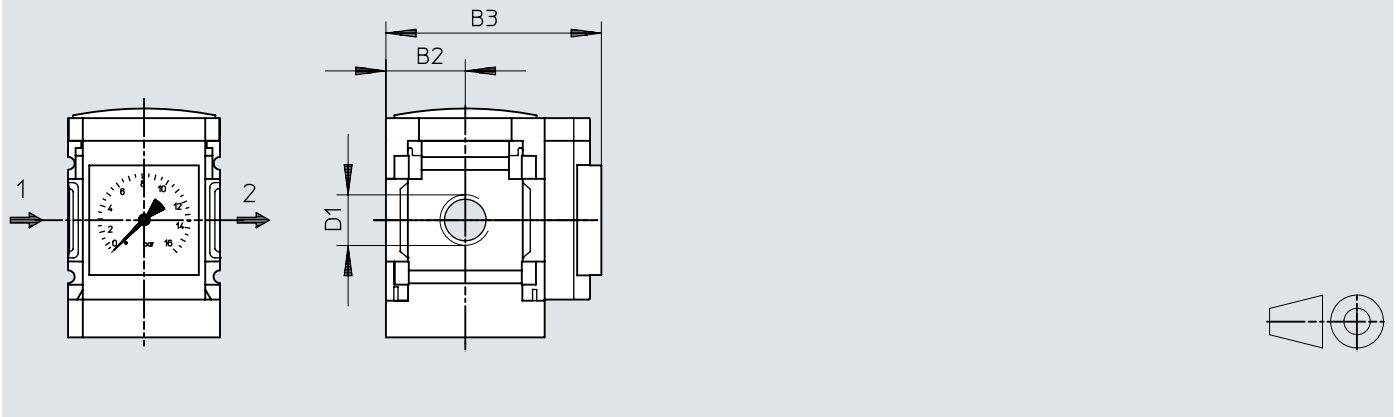

	B2	B3		D1
		1)	l	
MS6-FRM-1/4-...-AG	31	77	85	G1/4
MS6-FRM-3/8-...-AG				G3/8
MS6-FRM-1/2-...-AG				G1/2
MS6-FRM-1/4-...-RG	31	78,5	86,5	G1/4
MS6-FRM-3/8-...-RG				G3/8
MS6-FRM-1/2-...-RG				G1/2

1) Standard



## Dimensions

Dimensions – A8 adapter for EN pressure gauge 1/8, without pressure gauge,  
 A4 adapter for EN pressure gauge 1/4, without pressure gauge

Download CAD data → [www.festo.com](http://www.festo.com)

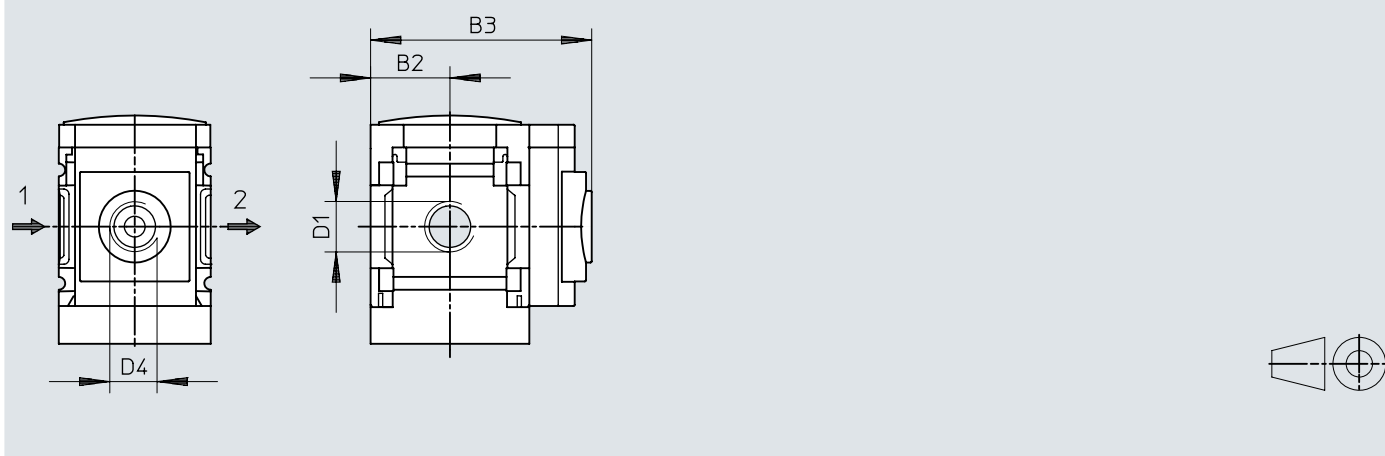

	B2	B3		D1	D4
		1)	l		
MS6-FRM-1/4-...-A8	31	78,5		G1/4	G1/8
MS6-FRM-3/8-...-A8				G3/8	
MS6-FRM-1/2-...-A8				G1/2	
MS6-FRM-1/4-...-A4	31	78,5		G1/4	G1/4
MS6-FRM-3/8-...-A4				G3/8	
MS6-FRM-1/2-...-A4				G1/2	

1) Standard

## Dimensions

Dimensions – AD7/AD8/AD9/AD10 Pressure sensor with status indicator

Download CAD data → [www.festo.com](http://www.festo.com)

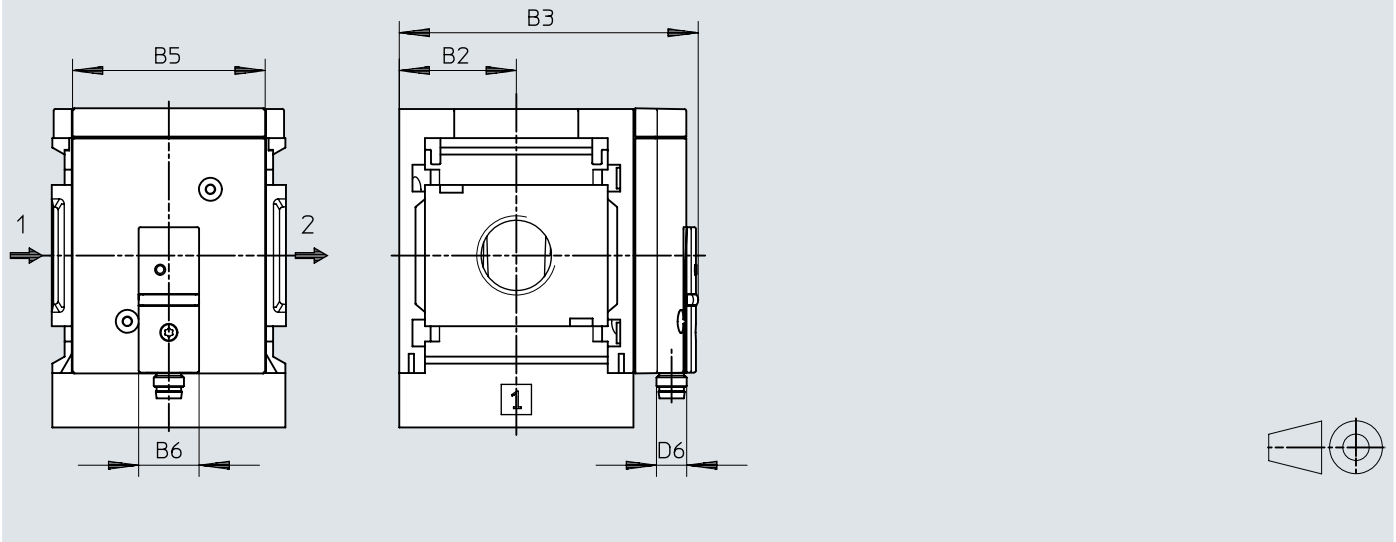

	B2	B3	B5	B6	D6
MS6-...-AD7, AD8, AD9, AD10	31	79,1	~51	16	M8x1

Dimensions

Dimensions – AD11, AD12 pressure sensor with LCD display

Download CAD data → [www.festo.com](http://www.festo.com)

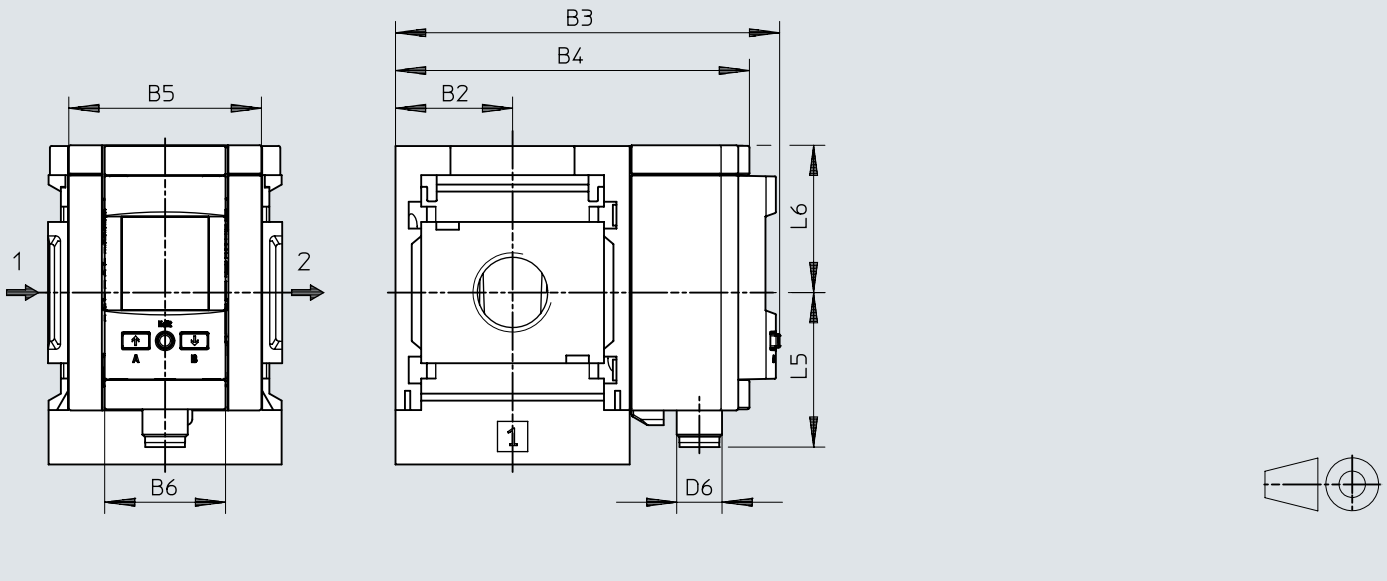

	B2	B3	B4	B5	B6	D6	L5	L6
MS6-...-AD11	31	101,8	93,7	51	32	M12x1	41,2	39
MS6-...-AD12						M8x1	37,9	

## Dimensions

Dimensions – X/Y pressure switch with adjustable pressure switching point

Download CAD data → [www.festo.com](http://www.festo.com)

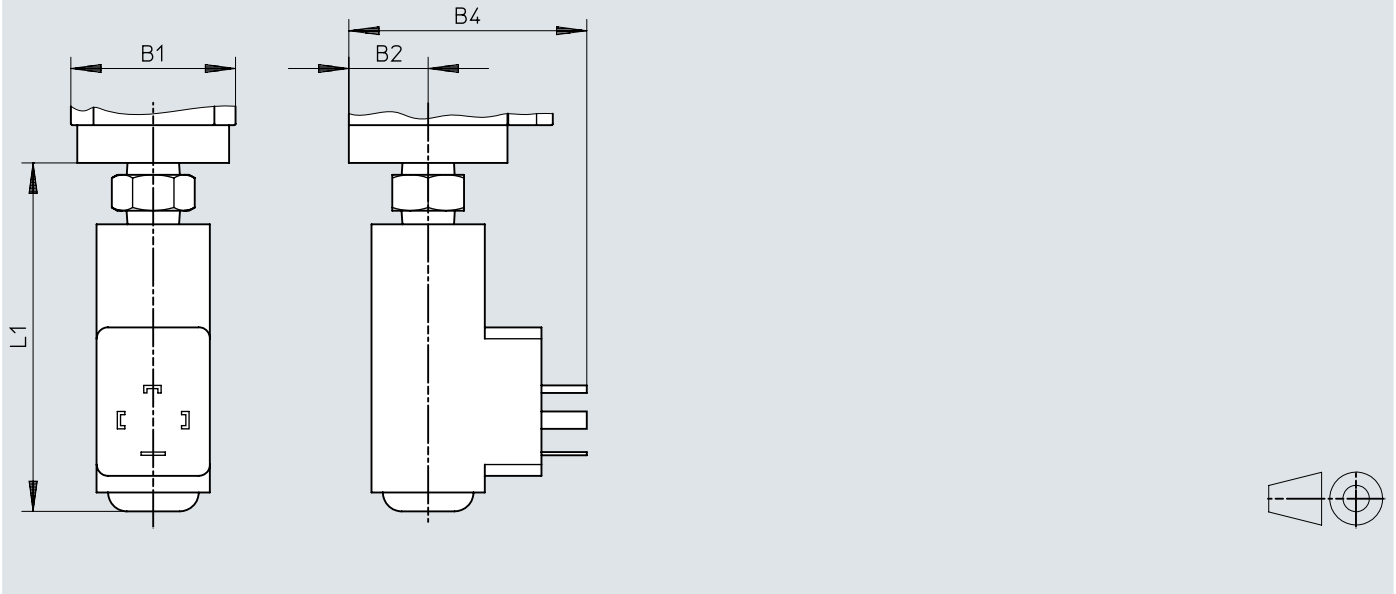

	B1	B2	B4	L1
MS6-FRM-...-X/Y	62	31	73	99

### Dimensions

Dimensions – M12 pressure switch with adjustable pressure switching point

Download CAD data → [www.festo.com](http://www.festo.com)

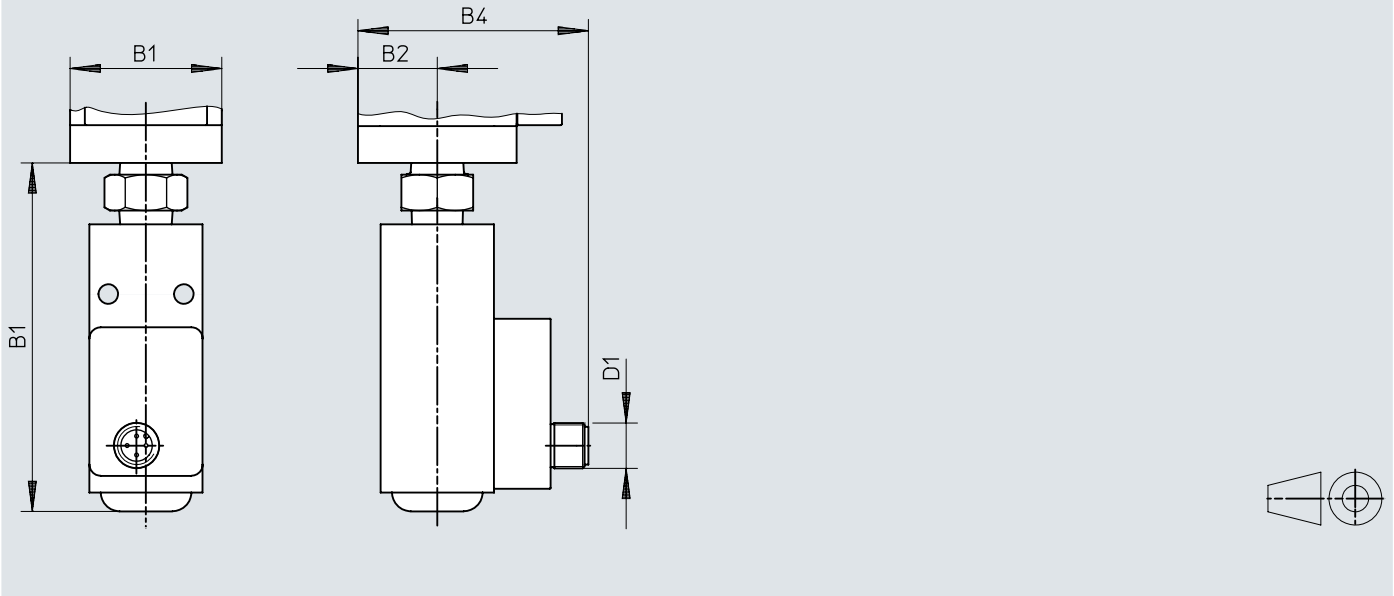

	B1	B2	B4	D1	L1
MS6-FRM-...-M12	62	31	71	M12x1	99

## Ordering data

Ordering data						
	Pneumatic connection, port 1	Flow direction	Design	Product weight	Part no.	Type
	G1/4	From left to right	Branching module, With non-return function	400 g	536967	MS6-FRM-1/4-I
			Branching module	458 g	529857	MS6-FRM-1/4
	736 g			529858	MS6-FRM-1/4-Y	
	458 g			529861	MS6-FRM-3/8	
	736 g			529862	MS6-FRM-3/8-Y	
	G3/8		Branching module, With non-return function	400 g	536969	MS6-FRM-1/2-I
	G1/2	From right to left		458 g	529856	MS6-FRM-1/2-Z
			From left to right	736 g	★ 529853	MS6-FRM-1/2
		From right to left		736 g	529854	MS6-FRM-1/2-Y
			736 g	529855	MS6-FRM-1/2-Y-Z	

### Ordering information – Products for battery production

	Pneumatic connection, port 1	Pressure gauge alternatives	Product weight	Part no.	Type
	G1/2	Adapter for EN pressure gauge 1/4, without pressure gauge	458 g	8183566	MS6-FRM-1/2-A4-F1A
		Adapter for EN pressure gauge 1/8, without pressure gauge		8183567	MS6-FRM-1/2-A8-F1A

### Ordering data – Modular product system

	Design	Part no.	Type
	Branching module	527676	MS6-FRM

## Peripherals

## Peripherals overview

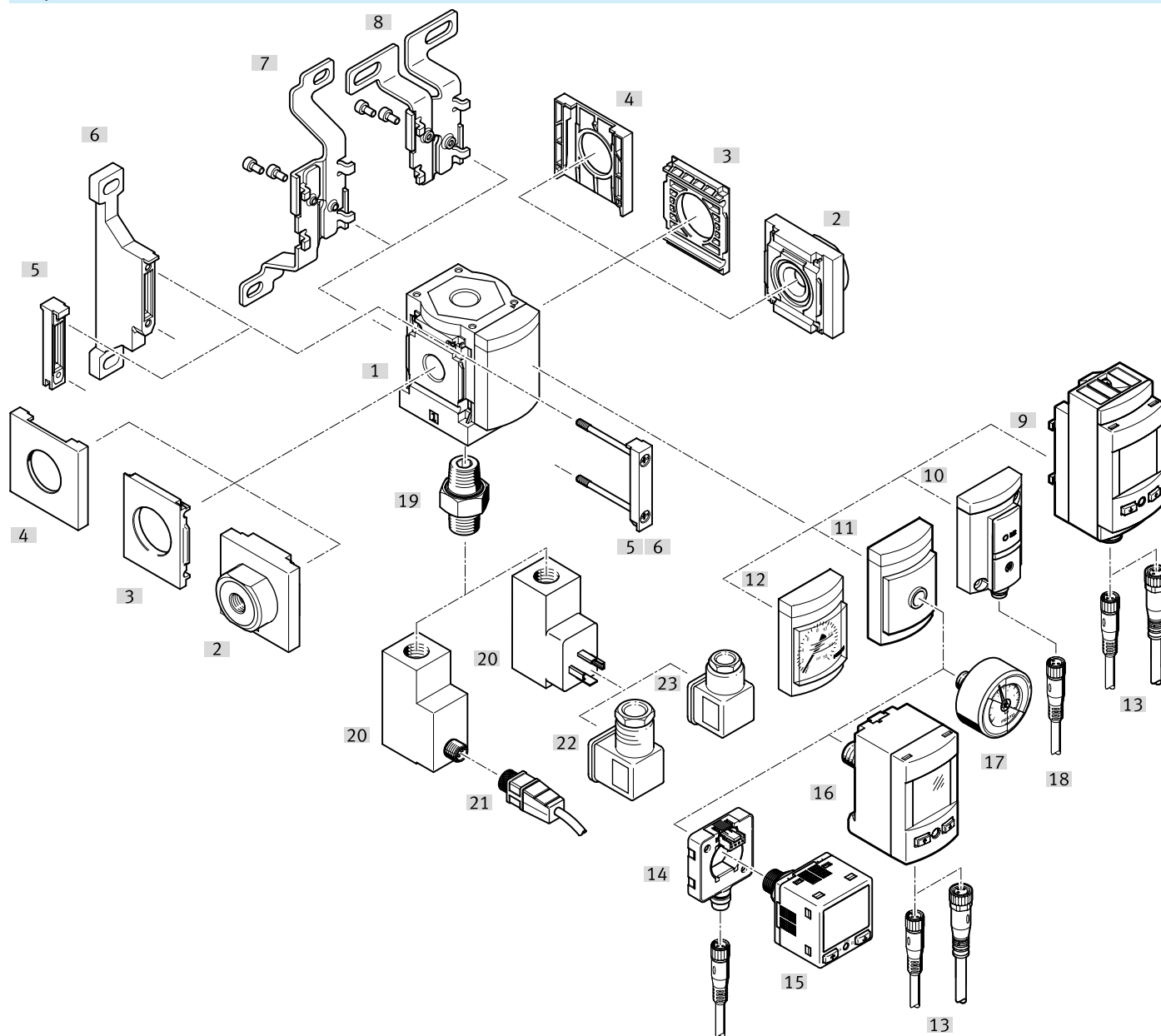

Accessories		→ Page/Internet
Type/order code	Description	
[1]	Branching module MS6-FRM	ms6-frm
[2]	Connecting plate-SET MS6-AG...	Module connector MS4/6-MV [5] or mounting bracket MS4-WP, WPB, WPE, WPM [6] is required for mounting.
[3]	Mounting plate MS6-AEND	Module connector MS4/6-MV [5] or mounting bracket MS4-WP, WPB, WPE, WPM [6] is required for mounting.
[4]	Cover cap MS6-END	18
[5]	Module connector MS6-MV	17
[6]	Mounting bracket MS6-WP	17
[6]	Mounting bracket MS6-WPB	Without illustration
[6]	Mounting bracket MS6-WPE	Without illustration
[6]	Mounting bracket MS6-WPM	Without illustration
[7]	Mounting bracket MS6-WB	17
[8]		-
[10]	Pressure sensor with LCD display SPAU	Order code [AD11], [AD12]
[11]	Pressure sensor with status indicator SDE5	Order code [AD7], [AD8], [AD9], [AD10]
[12]	Adapter for EN pressure gauge 1/8, 1/4	Order code [A8], [A4]

## Peripherals

Accessories		→ Page/Internet
Type/order code	Description	
[13]	Pressure gauge MS	Order code [AG], [RG] ms6-frm
[14]	Connecting cable NEBU-M8...-LE3, NEBU-M12...-LE4	18
[15]	Connecting cable NEBU-M8...-LE4, NEBU-M12...-LE4	18
[16]	Electrical adapter SASC	17
[17]	Pressure sensor SPAN	17
[18]	Pressure sensor SPAU-...-T	18
[19]	Pressure gauge MA	18
[20]	Connecting cable NEBU-M8...-LE3	18
[21]	Double nipple ESK	19
[22]	Pressure switch PEV	Order code: [X]/[Y]/[M12] Double nipple [21] is included in the scope of delivery. pev
[23]	Connecting cable NEBU-M12...-LE4	18
[24]	Angled plug socket PEV-1/4-WD-LED-...	19
[25]	Plug socket MSSD-C-4P	mssd

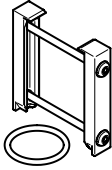
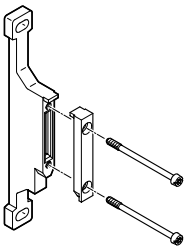
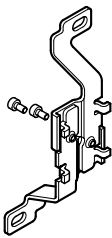
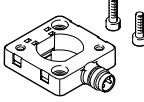
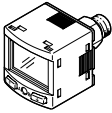

## Accessories

Module connector MS6-MV1				
	Size	Part no.	Type	
	6	★ 8119204	MS6-MV1	
		8176697	MS6-MV1-F1A	
Mounting bracket MS6-WP...				
	Size	Part no.	Type	
	6	★ 532195	MS6-WP	
		532186	MS6-WPM-2D	
		526073	MS6-WPM-D	
		★ 526074	MS6-WPB	
		541542	MS6-WPB-EX	
		8176698	MS6-WP-F1A	
		541544	MS6-WP-EX	
Mounting bracket MS6-WB				
	Size	Part no.	Type	
	6	★ 532196	MS6-WB	
Electrical adapter SASC				
	Short type code	Part no.	Type	
	SASC	★ 8000326	SASC-P4-A-M8-A	
Pressure sensor SPAN				
	Pneumatic connection	Analogue output	Part no.	Type
	Male thread G1/8, Female thread M5	0 - 10 V, 4 - 20 mA, 1 - 5 V	★ 8035544	SPAN-P10R-G18M-PN-PN-L1
			★ 8035533	SPAN-P10R-G18M-PNLK-PNVBA-L1
	Male thread R1/8, Female thread M5	0 - 10 V, 4 - 20 mA, 1 - 5 V	★ 8035547	SPAN-P10R-R18M-PN-PN-L1
			★ 8035536	SPAN-P10R-R18M-PNLK-PNVBA-L1

## Accessories

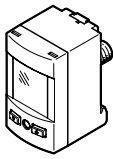
Pressure sensor SPAU-...-T						
	Pneumatic connection	Electrical connection 1, connector system	Part no.	Type		
	R1/8	M12x1, A-coded to EN 61076-2-101	8001206	SPAU-P10R-T-R18M-L-PNLK-PNVBA-M12D		
		M8x1, A-coded, to EN 61076-2-104	8001203	SPAU-P10R-T-R18M-L-PNLK-PNVBA-M8D		
	R1/4	M12x1, A-coded to EN 61076-2-101	8001208	SPAU-P10R-T-R14M-L-PNLK-PNVBA-M12D		
		M8x1, A-coded, to EN 61076-2-104	8001209	SPAU-P10R-T-R14M-L-PNLK-PNVBA-M8D		

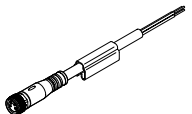
Connecting cable NEBU-M8						
	Electrical connection 1, connector system	Electrical connection 1, number of connections/cores	Electrical connection 1, cable outlet	Cable length	Part no.	Type
	M8x1, A-coded, to EN 61076-2-104	3	Straight	2.5 m	541333	NEBU-M8G3-K-2.5-LE3
				5 m	541334	NEBU-M8G3-K-5-LE3
			Angled	2.5 m	541338	NEBU-M8W3-K-2.5-LE3
				5 m	541341	NEBU-M8W3-K-5-LE3
		4	Straight	2.5 m	541342	NEBU-M8G4-K-2.5-LE4
				5 m	541343	NEBU-M8G4-K-5-LE4
			Angled	2.5 m	541344	NEBU-M8W4-K-2.5-LE4
				5 m	541345	NEBU-M8W4-K-5-LE4

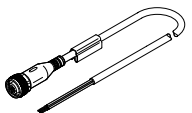
Connecting cable NEBU-M12						
	Electrical connection 1, connector system	Electrical connection 1, number of connections/cores	Electrical connection 1, cable outlet	Cable length	Part no.	Type
	M12x1, A-coded to EN 61076-2-101	5	Straight	2.5 m	541363	NEBU-M12G5-K-2.5-LE3
					550326	NEBU-M12G5-K-2.5-LE4
				5 m	541328	NEBU-M12G5-K-5-LE4
					541364	NEBU-M12G5-K-5-LE3
			Angled	2.5 m	550325	NEBU-M12W5-K-2.5-LE4
					541329	NEBU-M12W5-K-5-LE4

Pressure gauge MA			
	Pneumatic connection	Part no.	Type
	G1/4	183901	MA-40-16-G1/4-EN
	R1/8	525726	MA-40-16-R1/8-E-RG
	R1/4	187080	MA-40-16-R1/4-EN
		525729	MA-50-16-R1/4-E-RG

Cover cap MS6-END			
	Size	Part no.	Type
	6	538780	MS6-END

## Accessories

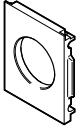
Mounting plate MS6-AEND					
	Size	Pneumatic connection		Part no.	Type
	6			535408	MS6-AEND1

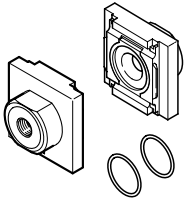

Connecting plate-SET MS6-AG...					
	Size	Pneumatic connection, port 1	Pneumatic connection, port 2	Part no.	Type
	6	G1/4	G1/4	526080	MS6-AGB
				541538	MS6-AGB-EX
		G3/8	G3/8	526081	MS6-AGC
				541539	MS6-AGC-EX
		G1/2	G1/2	★ 526082	MS6-AGD
				541540	MS6-AGD-EX
		G3/4	G3/4	★ 526083	MS6-AGE
				541541	MS6-AGE-EX

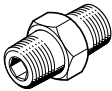

Double nipple ESK				
	Pneumatic connection, port 1	Pneumatic connection, port 2	Part no.	Type
	R1/4	R1/4	151521	ESK-1/4-1/4
		R1/2	534153	ESK-1/4-1/2

Angled plug socket PEV						
	Operational voltage range AC	Operational voltage range DC	Electrical connection	Switching status indication	Part no.	Type
		15 ... 30 V		Yellow LED, Green LED	164274	PEV-1/4-WD-LED-24
	150 ... 230 V	140 ... 180 V			164275	PEV-1/4-WD-LED-230

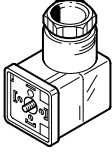
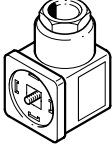
Plug socket MSSD				
	Electrical connection	Type of mounting	Part no.	Type
	3-pin, Angled socket, Type A, To DIN EN 175301-803, Square design MSC, Square design MSN1	On solenoid valve via M3 central screw	171157	MSSD-C-4P