

AND Module Type ZK-2-R-M5

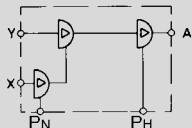

OR Module Type OS-2-R-M5

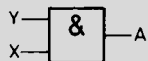
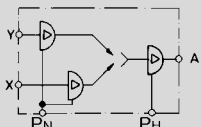
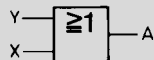

NOT Module Type VLO-R-M5

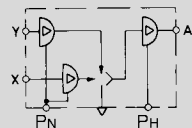
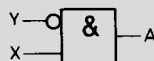

Amplifier Module Type VK-R-M5

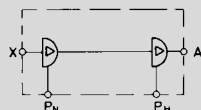

Dimensions, See page 207.

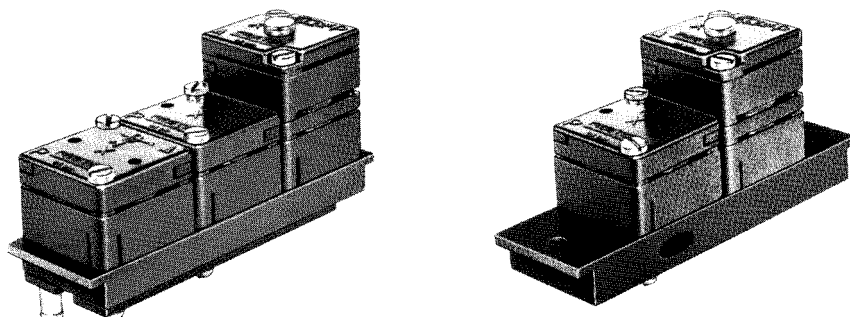

These elements amplify and process output signals from pneumatic sensors with pressures of 0.02 to 3.8 psi / 0.001 to 0.25 bar.

Each element is factory-mounted on a 2n width mounting plate.

Function:

Type ZK-2-R-M5

AND logic amplification element for pneumatic sensors. An output is present at A if both X and Y are present.

Type OS-2-R-M5

OR logic amplification element for pneumatic sensors. An output is present at A if either X or Y is present.

Type VLO-R-M5

Logic amplification element for pneumatic sensors. An output is present at A if X is present and Y is NOT present.

Type VK-R-M5

Amplifier element for pneumatic sensors with two-stage amplification. An output is present at A if X is present.

For the sub-base, internal connections are accomplished by means of integrated air channels.

Signal inputs X and Y of the four elements are supplied with low pressure (sensor output signals). The output at A is a high pressure signal (supplied by PH).

An air pressure supply of 15 to 105 psi / 1 to 7 bar is required at PH. An additional air pressure supply of 1.5 to 3.8 psi / 0.1 to 0.25 bar is required at connection PN.

Order Number	Part No./Type	7421 ZK-2-R-M5	7423 OS-2-R-M5	7422 VLO-R-M5	7425 VK-R-M5
Medium		Compressed air (through 5 micron filter, dried, unlubricated)			
Mounting		On 2n mounting racks			
Connection		PN, X, Y: Barbed fitting for 1/4 in / 4 mm tubing; PH, A: M5			
Orifice Size		Low pressure: 1/4 in / 4 mm. High pressure: 0.098 in / 2.5 mm			
Air Flow (P→A)		2.8 SCFM / 80 l/min			
Supply Pressure Range at PN*		1.5 to 3.8 psi / 0.1 to 0.25 bar			
Signal Pressure Range at PH		15 to 105 psi / 1 to 7 bar			
Control Pressure Range at X, Y		0.015 to 4 psi / 0.001 to 0.25 bar			
Constant Air Consumption, Not Actuated		Low pressure: 0.05 SCFM at 1.5 psi / 1.4 l/min at 0.1 bar. High pressure: 3.15 SCFM at 90 psi / 3.6 l/min at 6 bar.			
Ambient Temperature		14 to 140°F / -10 to +60°C†			
Design		Seat valve, piloted			
Material		Housing: plastic. Seals: Buna N. Mounting plate: Al, plastic			
Weight		0.192 lb / 0.087 kg			0.165 lb / 0.075 kg

* 14 to 140°F / -10 to +60°C temperature range of medium

† Depending on tubing used

Festo - Your Partner in Automation



1 Festo Inc.
5300 Explorer Drive
Mississauga, ON L4W 5G4
Canada

Festo Customer Interaction Center
Tel: 1 877 463 3786
Fax: 1 877 393 3786
Email: customer.service.ca@festo.com



2 Festo Pneumatic
Av. Ceylán 3,
Col. Tequesquináhuac
54020 Tlalnepantla,
Estado de México

Multinational Contact Center
01 800 337 8669
ventas.mexico@festo.com



3 Festo Corporation
1377 Motor Parkway
Suite 310
Islandia, NY 11749

Festo Customer Interaction Center
1 800 993 3786
1 800 963 3786
customer.service.us@festo.com



4 Regional Service Center
7777 Columbia Road
Mason, OH 45040

Connect with us



www.festo.com/socialmedia



www.festo.com

Subject to change