

Piezo valve VEAE

FESTO



Key features

Special characteristics

- Energy consumption < 0.1 W at 5 Hz
- No self-heating
- No operating noise
- Extremely long service life
- For use with compressed air or inert gases, including oxygen
- Small and lightweight

Mode of operation

Description

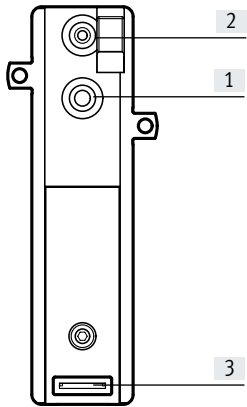

- [1] Port 1, pressure supply port
- [2] Port 2, working port
- [3] Electrical connection

The VEAE is a proportional 2/2-way valve in which a piezo actuator is controlled electrically.

In the normal position, the valve is closed. Pressure supplied at port 1 supports the closing function.

The flow rate can be controlled via a closed-loop control circuit by integrating a flow sensor in the output line.

Control response

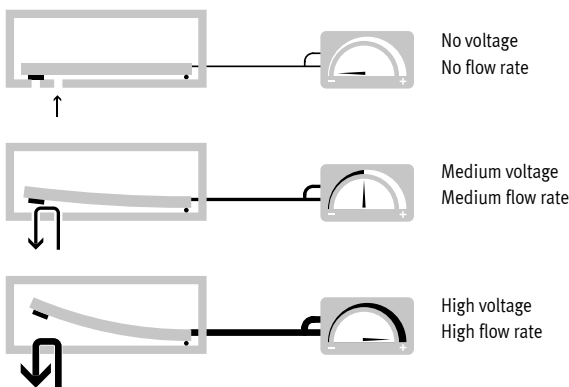

The piezo actuator is controlled using variable voltage to give proportional closed-loop control.

The piezo valve VEAE exhibits the typical hysteresis behaviour of a proportional valve. Linear behaviour can be achieved by combining control electronics with a flow sensor.

This allows either the pressure or flow rate to be controlled, depending on the design.

The pressure or flow behaviour is controlled by integrating a sensor in the output line of the closed-loop control circuit.

Low energy consumption

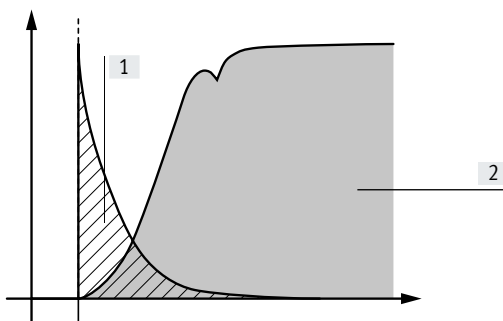

Y-axis: Current I

X-axis: Time t

- [1] Striped area: Piezo valve
- [2] Grey area: Solenoid valve

Compared with solenoid valves, proportional valves with piezo technology require virtually no energy to maintain an active state thanks to their capacitive principle. The piezo valve operates like a capacitor: it needs current only at the start in order to charge the piezoceramics. No further energy is needed to maintain its state. The valves therefore generate no heat.

They consume up to 95% less energy than solenoid valves, which permanently require an electrical current. For an EMERGENCY OFF circuit, in which the valve is meant to close, the piezo valve connection needs to be earthed. In the event of a simple separation of the connection, the piezo actuator remains in its current position for a while due to its capacitive principle.

Peripherals overview

Example of piezo valve VEAE with sub-base

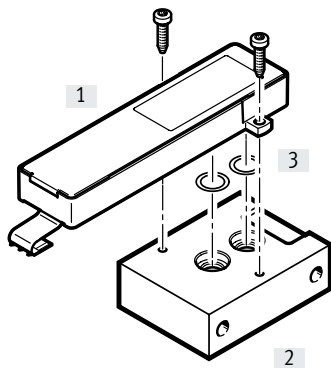

Designation	→ Page/Internet
[1] Piezo valve VEAE	12
[2] Sub-base VABS	12
[3] Seal assortment VABD	12

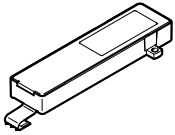

Product range overview

Function	Description	Nominal width	Flow rate	Operating pressure			Operating voltage	
		[mm]	[l/min]	[MPa]	[bar]	[psi]	0 ... 300 V	
Sub-base valve		2/2-way valve, normally closed, monostable						
		Flange	1.2	50 ... 60	0 ... 0.6	0 ... 6	0 ... 87	■
		2/2-way valve, normally closed, monostable						
		Flange	1.5	58 ... 81	0 ... 0.6	0 ... 6	0 ... 87	■
		2/2-way valve, normally closed, monostable						
		Flange	1.7	47 ... 63	0 ... 0.3	0 ... 3	0 ... 43.5	■

Type codes

001	Series	005	Nominal width [mm]
VEAE	Piezo valve	1.2	1.2
		1.5	1.5
		1.7	1.7
002	Directional control valve type	006	Pressure range [bar]
B	Sub-base valve	D22	0 ... 3
		D9	0 ... 6
003	Inflow direction	007	Electrical connection
B	Over seat	X4	ZIF connection/standard flexible conductor
004	Valve function		
6	2/2-way valve, normally closed		

Datasheet

-  Flow rate
47 ... 81 l/min
-  Voltage
300 V
-  Operating pressure
0 ... 0.3 MPa
0 ... 0.6 MPa



General technical data		VEAE-BB-6-12-D9-X4	VEAE-BB-6-15-D9-X4	VEAE-BB-6-17-D22-X4
Valve function		2/2-way valve, monostable		
Normal position		Normally closed		
Reset method		Mechanical spring		
Standard nominal flow rate	[l/min]	50 ... 60	58 ... 81	47 ... 63
Note on standard nominal flow rate		Production-related tolerances		
Total leakage	[l/h]	0.4		
Type of control		Direct		
Sealing principle		Soft		
Dimensions W x L x H	[mm]	64 x 24 x 12		
Nominal width	[mm]	1.2	1.5	1.7
Grid dimension	[mm]	20.5		
Pneumatic connection 1, 2		Flange		
Actuation type		Electrical		
Type of mounting		Via through-hole		
Mounting position		Any		
Direction of flow		Not reversible		
Product weight	[g]	10		
Special characteristics		Oxygen-compatible to DIN EN 1797		

Operating and environmental conditions		VEAE-BB-6-12-D9-X4	VEAE-BB-6-15-D9-X4	VEAE-BB-6-17-D22-X4
Operating pressure	[MPa]	0 ... 0.6	0 ... 0.6	0 ... 0.3
	[bar]	0 ... 6	0 ... 6	0 ... 3
	[psi]	0 ... 87	0 ... 87	0 ... 43.5
Burst pressure	[MPa]	2.5		
	[bar]	25		
	[psi]	362.5		
Nominal operating pressure	[MPa]	0.5	0.5	0.3
	[bar]	5	5	3
	[psi]	72.5	72.5	43.5
Medium		<ul style="list-style-type: none"> • Compressed air to ISO 8573-1:2010 [5:3:1] • Inert gases • Oxygen (oxygen applications to IEC 60601-1 only on request) 		
Oxygen suitability to standard		ASTM G 63		
		ASTM G 93		
		ISO 15001		
Biocompatibility to standard		ISO 18562		
Note on the medium		Lubricated operation not possible		
Ambient temperature	[°C]	-10 ... 60		
Temperature of medium	[°C]	-10 ... 60		
Storage temperature	[°C]	-20 ... 70		
Relative humidity	[%]	0 ... 60		
		Non-condensing		
Pressure dew point	[°C]	≤ -20		
Grade of filtration	[µm]	≤ 5		
Degree of protection		IP40, in assembled state		
Corrosion resistance class CRC ¹⁾		2 - Moderate corrosion stress		

1) More information: www.festo.com/x/topic/kbk

Datasheet

Electrical data		VEAE-BB-6-12-D9-X4	VEAE-BB-6-15-D9-X4	VEAE-BB-6-17-D22-X4
Nominal operating voltage	[V DC]	300		
Operating voltage range	[V DC]	0 ... 300		
Electrical connection		Plug		
		Flexible circuit board connector, pitch 2.5 mm		
		3-pin		
Max. electrical power consumption	[W]	0.1 at 5 Hz		
Max. current consumption	[mA]	11		
Max. switching frequency	[Hz]	12		
Duty cycle	[%]	100		

Safety characteristics	
Shock resistance	Shock test with severity level 2 to FN 942017-5 and EN 60068-2-27
Vibration resistance	Transport application test with severity level 2 to FN 942017-4 and EN 60068-2-6

- 1) For information about the area of use, see the EC declaration of conformity at: www.festo.com/catalogue/... → Support/Downloads.
If the devices are subject to usage restrictions in residential, commercial or light-industrial environments, further measures for the reduction of the emitted interference may be necessary.

Materials	
Seals	EPDM
Housing	Reinforced PA
Note on materials	RoHS-compliant
	Contains paint-wetting impairment substances

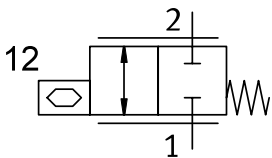
Design	
Circuit symbol	
	<ul style="list-style-type: none"> • 2/2-way valve, normally closed

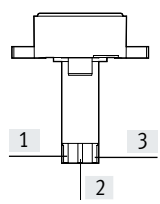
Pin allocation			
	Pin	Allocation	
		Analogue	
	1	Power supply 0 ... 300 V	The charge and discharge current must be limited to 11 mA. If the current is not regulated by the controller, this can be achieved using a 27 kOhm resistor connected in series.
	2	GND	
	3	GND	

Datasheet

VEAE-BB-6-12-D9-X4

Flow rate q_n as a function of voltage at an operating pressure of 0.5 MPa (5 bar)

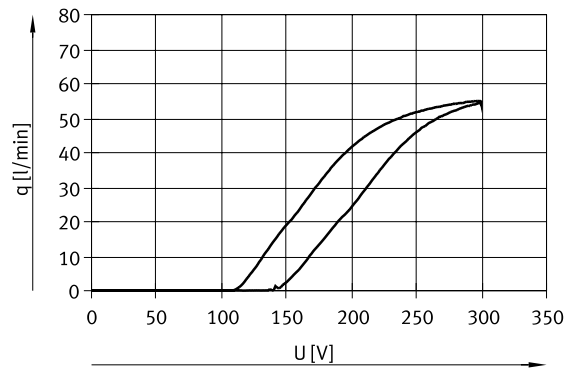

Flow rate q_n as a function of operating pressure at 300 V

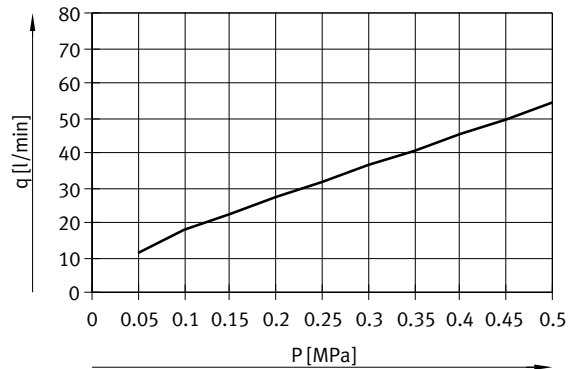

Flow rate q_n as a function of switch-on point at 300 V and an operating pressure of 0.5 MPa (5 bar)

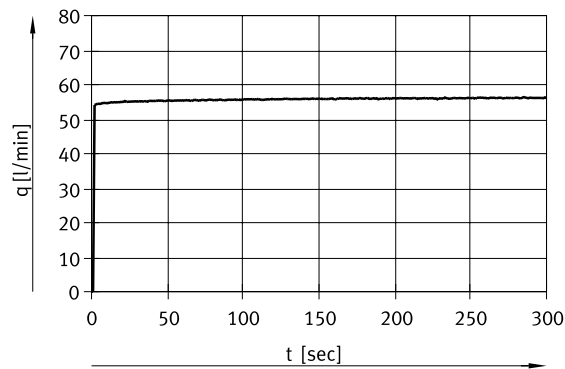

Flow rate q_n as a function of ambient temperature at 300 V

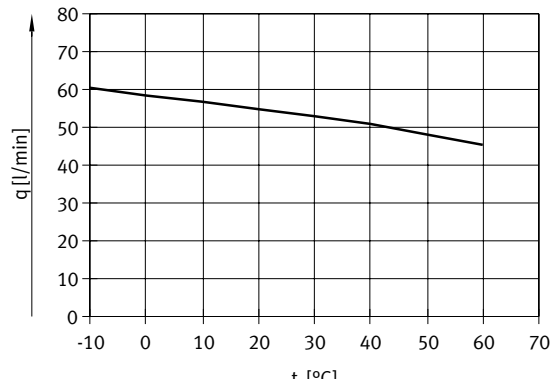

Voltage to open and close the valve as a function of operating pressure at 300 V

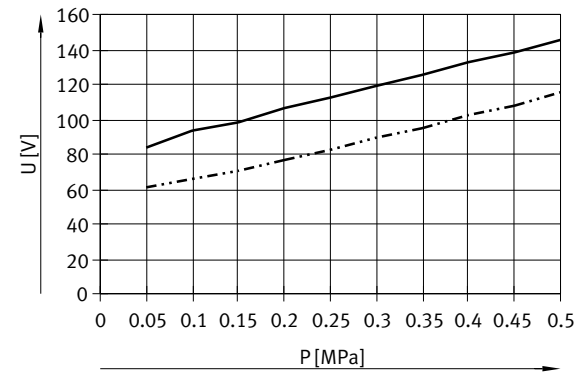

Datasheet

VEAE-BB-6-15-D9-X4

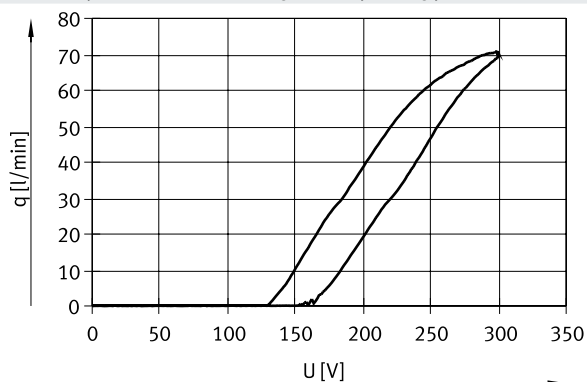
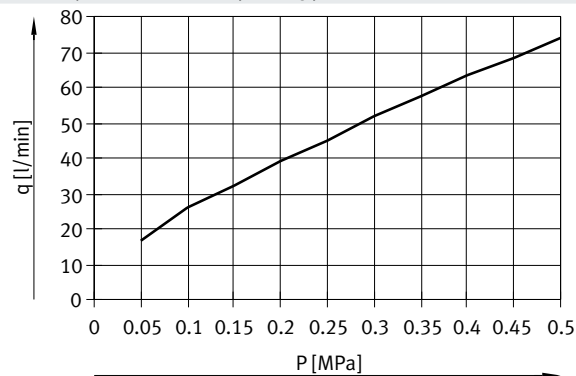
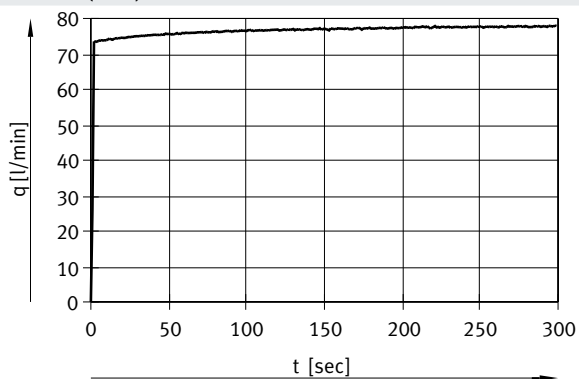
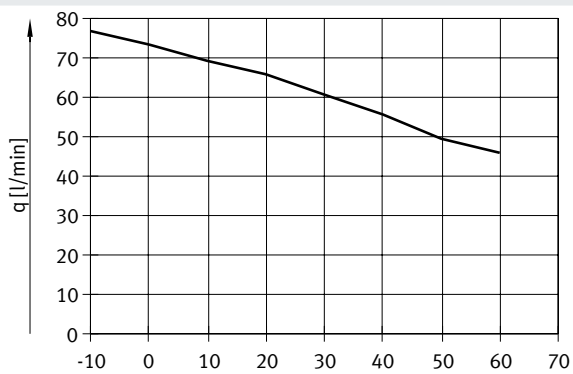
Flow rate q_n as a function of voltage at an operating pressure of 0.5 MPa (5 bar)Flow rate q_n as a function of operating pressure at 300 VFlow rate q_n as a function of switch-on point at 300 V and an operating pressure of 0.5 MPa (5 bar)Flow rate q_n as a function of ambient temperature at 300 V

Voltage to open and close the valve as a function of operating pressure at 300 V

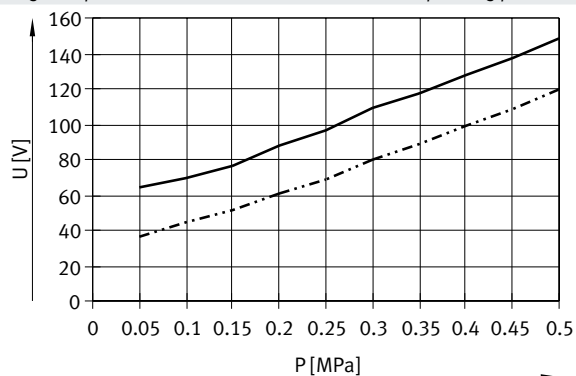

Datasheet

VEAE-BB-6-17-D22-X4

Flow rate q_n as a function of voltage at an operating pressure of 0.3 MPa (3 bar)

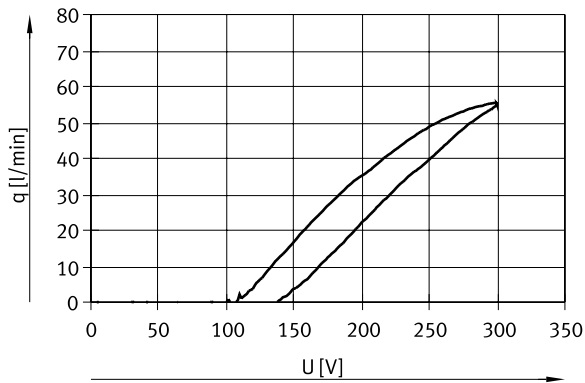

Flow rate q_n as a function of operating pressure at 300 V

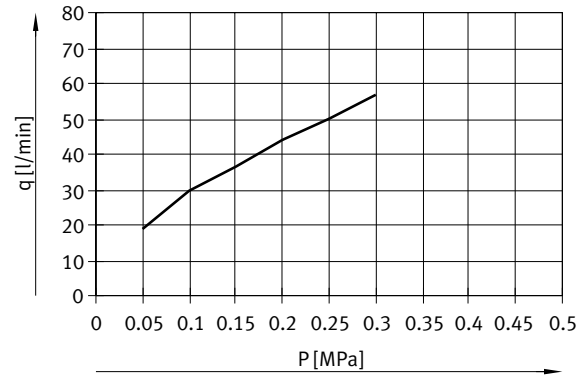

Flow rate q_n as a function of switch-on point at 300 V and an operating pressure of 0.3 MPa (3 bar)

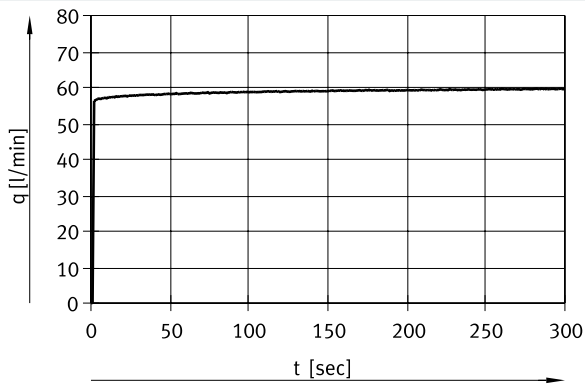

Flow rate q_n as a function of ambient temperature at 300 V

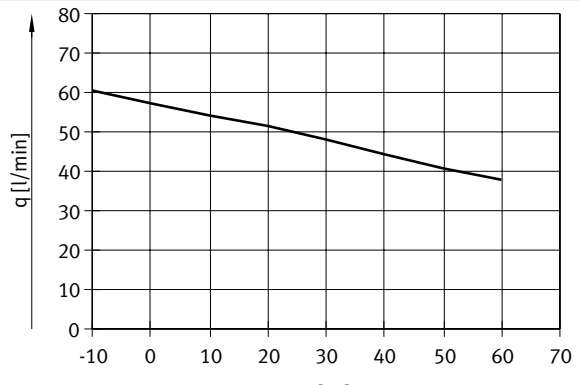

Voltage to open and close the valve as a function of operating pressure at 300 V

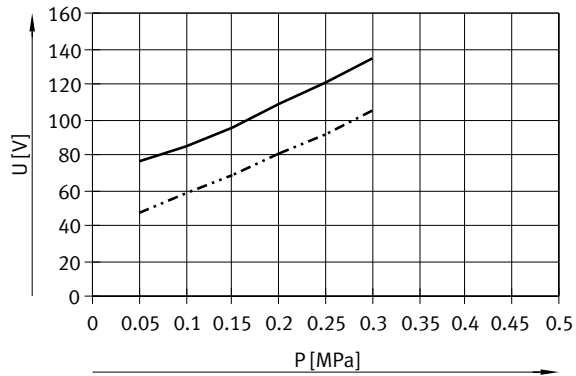

Datasheet

Dimensions

Download CAD data → www.festo.com

Piezo valve VEAE

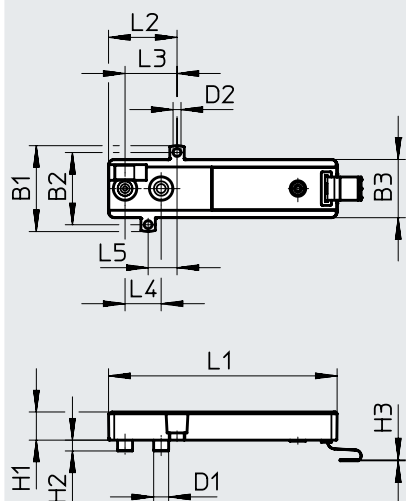

Type	B1	B2	B3	D1 ∅	D2 ∅	H1	H2	H3	L1	L2	L3	L4	L5
VEAE	24	20	16.4	4.2	2.2	7.9	3	0.3	63.3	19	14.4	10	8

Dimensions

Download CAD data → www.festo.com

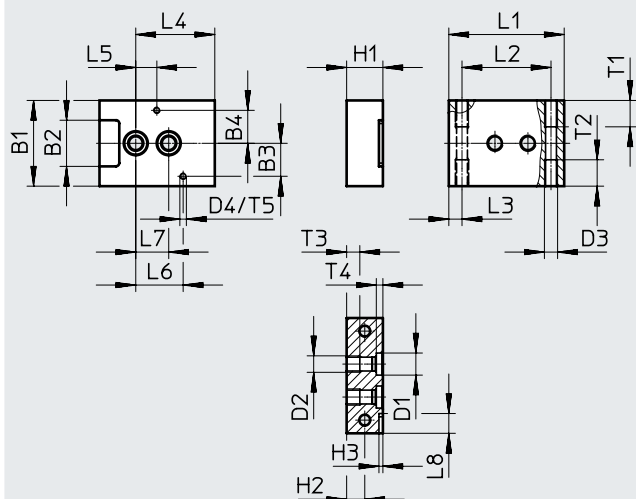

Manifold block VABS



Type	B1	B2	B3	B4	D1 ∅	D2	D3	D4	H1	H2	H3
VABS	26	14	10	10	6.7	M5	M4	M2x7	11	5.5	1.2

Type	L1	L2	L3	L4	L5	L6	L7	L8	T1	T2	T3	T4	T5
VABS	35	27	4	24	6.4	14.4	10	6	8	8	4	2	8

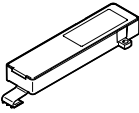
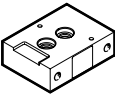
Accessories

Ordering data	Description	Nominal width [mm]	Operating pressure			Part no.	Type
			[MPa]	[bar]	[psi]		
Sub-base valve							
	2/2-way valve, closed, monostable	1.2	0 ... 0.6	0 ... 6	0 ... 87	8078916	VEAE-BB-6-12-D9-X4
		1.5	0 ... 0.6	0 ... 6	0 ... 87	8078914	VEAE-BB-6-15-D9-X4
		1.7	0 ... 0.3	0 ... 3	0 ... 43.5	8078917	VEAE-BB-6-17-D22-X4
Sub-base							
	For 2/2-way valve, with 2 pneumatic connections M5					8097804	VABS-P16-10S-M5
Sealing ring assortment							
	200 pieces (for 100 VEAE valves), oxygen-compatible					8097798	VABD-P16-S