

Valve terminal CPV, Compact Performance

FESTO



Key features



Innovative

- Cubic design for exceptional performance and low weight
- Low installation and bus connection costs
- Decentralised machines and system structures, for example
 - in handling technology
 - in conveyor technology
 - in the packaging industry
 - in sorting systems
 - in upstream machine functions
- Integrated diagnostics, condition monitoring (Fieldbus Direct)
- With Fieldbus Direct, string extension from 8 ... 32 inputs and 8 ... 32 outputs is possible without any problems (depending on version).

Versatile

- Flexible and cost-effective connection of two to eight valve slices
- Highly flexible thanks to:
 - various pneumatic functions (valve variants)
 - different pressure ranges
 - vacuum switch
 - integrated vacuum generation
- Separator plates for creating pressure zones
- Valves with integrated separation of ducts 1 and 11
- Blanking plates for later extensions

Reliable

- LED indicators
- Manual overrides for valves
- Protection class to IP65
- Protection class IP65 also in conjunction with pneumatic multiple connector plate for control cabinet installation
- CE marking
- Certification (see technical data)

Easy to install

- Ready-to-install and tested unit
- Reduced selection, ordering, installation and commissioning costs
- Secure mounting on a wall or H-rail
- Pneumatic multiple connector plate – quick mounting with the tubing in place
- Optimised assembly for control cabinets

Key features

CPV – The benefits at a glance

The valve assembly CPV has a unique design. It allows a flexible mix of pneumatic performance, electrical connection technologies and a variety of installation types. In particular, the pneumatic multiple connector plate enables especially space-saving installation in control cabinets. The valve terminal can often be installed directly in the previously unused wall area of the control cabinet. There is no need to connect up the valves inside the cabinet. All tubes can be connected on the outside. Instead of individual drilled holes, the pneumatic multiple connector plate needs just one rectangular through-hole.

The generously sized flow ducts and powerful flat plate silencers ensure high flow rates. All valves are provided as valve slices. They have a compact and flow-optimised design. With two functions per valve slice (e.g. 2x 3/2-way valves), double the component density can be achieved. This saves space and reduces costs.

The cubic design permits exceptional performance with a comparatively low weight. These advantages become clear when the valve terminal is moved along on a drive. Despite it being compact, it is also very sturdy. The connecting threads and mounting attachments are metal.

The manual override for the valves can be adapted for different operating situations. If, for example, a detenting manual override is required for set-up, this can later be easily changed again so that inadvertent actuation during operation is prevented. The clear, large labelling systems also contribute to safe operation. One particular advantage is the large number of electrical connection technologies. All types of valve control are possible, from individual valve connection to a flexibly expandable bus system. The integration of electric input and output modules permits low-cost solutions in a range of installation concepts.

The design principle

Each side of the cubic design has its own specific function. Thus, for example, the electrical connection is mounted on the top. An optional inscription label holder can be placed on the front of the valve terminal.

The different possible combinations allow the best possible solution for the task in hand.

- Pneumatic supply connections on the left, right or underneath

- Pneumatic working ports and function blocks (vertical stacking) underneath
- Manual operation/identification from the front
- Electrical connection surface on top

- Mounting surface on the back, or at the front via pneumatic multiple connector plate

Main features

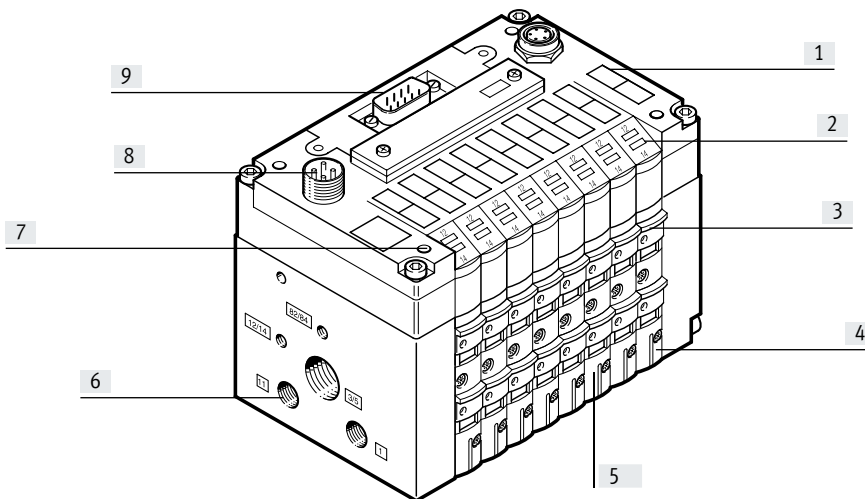

- [1] Inscription labels
- [2] Reduced downtimes: on-site LED diagnostics
- [3] Safe operation: manual override, non-detenting, detenting or blocked
- [4] Comprehensive range of valve functions, pressure zone formation, blanking plates

- [5] Width:
 - 10 mm,
 - 14 mm,
 - 18 mm
- [6] Robust metal thread or pre-assembled QS connectors

- [7] Quick mounting:
 - Directly using screws
 - On an H-rail
 - Via the pneumatic multiple connector plate
- [8] Operating voltage connection

- [9] Simple electrical connections:
 - Individual connection/ET200X/ET200pro
 - Multi-pin plug
 - AS-Interface
 - I-Port interface/IO-Link®
 - Installation system CP/CPI
 - Fieldbus Direct

Key features

Equipment options

Valve functions

- 5/2-way valve, single solenoid
- 5/2-way valve (with duct separation 1, 11), single solenoid
- 5/2-way valve, single solenoid, fast-switching
- 5/2-way valve, double solenoid
- 5/2-way valve (with duct separation 1, 11), double solenoid
- 2x 3/2-way valve, normally closed
- 2x 3/2-way valve (with duct separation 1, 11), normally closed
- 2x 3/2-way valve, normally open
- 2x 3/2-way valve (with duct separation 1, 11), normally open
- 2x 3/2-way valve, 1x normally open, 1x closed
- 2x 3/2-way valve (with duct separation 1, 11), 1x normally open, 1x closed
- 2x 3/2-way valve, normally closed, integrated back pressure protection
- 5/3-way valve, mid-position closed
- 2x 2/2-way valve, normally closed
- 2x 2/2-way valve (with duct separation 1, 11), normally closed
- 2x 2/2-way valve, 1x normally open, 1x closed
- 2x 2/2-way valve (with duct separation 1, 11), 1x normally open, 1x closed
- Vacuum generator
- Vacuum generator and 2/2-way valve with ejector pulse

Special features

Individual connection

- 2 ... 8 valve positions, max. 16 solenoid coils

Multi-pin plug connection

- 4, 6 or 8 valve positions, max. 16 solenoid coils

AS-Interface

- 2, 4 or 8 valve positions, max. 8 solenoid coils
- 4 or 8 inputs for 4 or 8 valve positions

I-Port interface/IO-Link®

- 8 valve positions, max. 16 solenoid coils
- Direct connection to the CTEU/CTEL installation system from Festo (I-Port)
- Connection to an IO-Link® master

Installation system CP/CPI

- 4, 6 or 8 valve positions, max. 16 solenoid coils
- Additional valve terminals and I/O modules having CP/CPI function can be connected via CP/CPI string extension

Fieldbus Direct

- 8 valve positions, max. 16 solenoid coils
- Additional valve terminals and I/O modules having CP/CPI functions can be connected via CP/CPI string extension

Key features

System analysis with explosion protection

Valve terminals CPV

Valve terminals CPV can be used in explosion protection. Please observe permitted versions, accessories as well as the operating conditions. Corresponding information can be found in this document, marked with  or NEC 500.

Additional user documentation with information about function, application, commissioning, operating conditions, maintenance and care can be found on the product pages for the valve terminal under Support/Download.

ATEX II 3G

The correctness of particular features is indicated by the product configuration. If the ATEX feature (code: EX1E) is selected with a valid configuration, valve terminals will have ATEX identification to ATEX II 3G on the end plate. Accessories that have been assessed can be found in the chapter on ATEX accessories.

NEC 500, Class I, Div.2

If a valid configuration is selected, valve terminals with electrical connection (code MP, IC) are identified with "Class I, Division 2, Groups A, B, C and D" on the end plate. Accessories that have been assessed can be found in the chapter NEC 500 accessories.

Tubing connections

Please use push-in fittings with G thread to ensure an electrically conductive connection. Suitable fittings can be found in the chapters on ATEX accessories or NEC 500 accessories.

Mechanical/pneumatic installation

When used in explosion protection areas, valve terminals CPV should be installed in suitable control cabinets or protective housing. Please observe the additional user documentation for potentially explosive operating conditions.

Installing a valve terminal CPV with a pneumatic multiple connector plate



Valve terminals CPV can be installed directly in the housing wall via a suitable opening using a pneumatic multiple connector plate (code GQC, GQD, GQE). This ensures tubing connections are on the outside of the control cabinet.

Wall or H-rail mounting of a valve terminal CPV inside a control cabinet



Valve terminals CPV can be positioned inside the control cabinet using wall or H-rail mounting.

Key features

Electrical connections

Individual connection (valve manifold assembly)

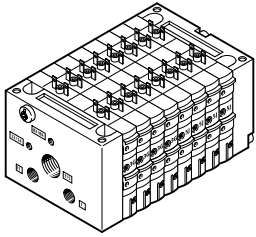

Connection is independent of the control technology and flexible using pre-assembled cables. This ensures that the connection is reverse polarity protected. The connector plug includes an LED for switching status indication and circuitry to protect against over-voltage. It also features a built-in cur-

rent reduction circuit. 2 to 16 solenoid coils (divided between two to eight valve slices, including odd numbers) can be selected with individual connection.

An intrinsically safe version completes the range.
More information

→ Internet: cpv10-ex-vi

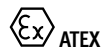

For valve terminals CPV10, CPV14 or CPV18, use the configuration value "EX1E" for the "EU certification" feature and "IC" for the feature "Electrical connection".

NEC 500

For valve terminals CPV10, CPV14 or CPV18, use the configuration value "IC" for the feature "Electrical connection".

Note

For CPV10 or CPV14, use the following connecting cables:

- 8047676
NEBV-Z3WA2L-R-E-2.5-N-LE2-S1
- 8047677
NEBV-Z3WA2L-R-E-5-N-LE2-S1
- 8047675
NEBV-Z3WA2L-R-E-10-N-LE2-S1

For CPV18, use the following connecting cables:

- KMEB-2-24-..

ET200X/ET200pro pneumatic interface for CPV10 and CPV14

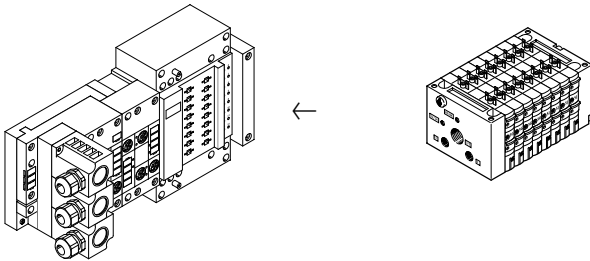

Adaptation of the valve manifold assembly CPV to the input/output module ET200X/ET200pro from Siemens: Combining the function modules of ET200X/ET200pro with the pneumatic functions of the valve manifold assembly CPV creates a highly integrative automation solution for systems for electric and pneumatic drives with:

- 8 valve slices for up to 16 CPV valves
- Faster and more reliable contacting to IP65

- Valve manifold assembly CPV10 and CPV14
- Not permitted for CPV10-EX-VI
- High degree of protection IP65/IP67
- Modular design

Key features

Multi-pin plug connection

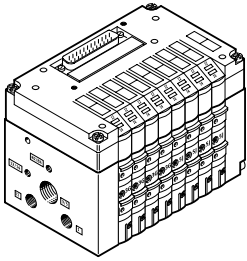

Control signals from the controller to the valve terminal are transmitted via a pre-assembled multi-core cable, which substantially reduces installation time. The current reduction for the valves is also integrated in the multi-pin plug connection.

This valve terminal can be equipped with 4 to 16 solenoid coils (4, 6 or 8 valve slices).

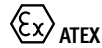

For valve terminals CPV10, CPV14 or CPV18, use the configuration value "EX1E" for the "EU certification" feature and "MP" for the feature "Electrical connection".

NEC 500

For valve terminals CPV10, CPV14 or CPV18, use the configuration value "MP" for the feature "Electrical connection".



Note

Use the following connecting cables

- KMP3-...
- KMP4-...

AS-Interface connection

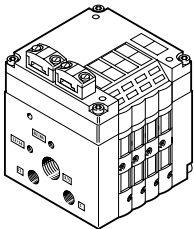

A special feature of the AS-Interface is the simultaneous transmission of data and supply power via a two-core cable. The encoded cable profile prevents connection with reverse polarity. If the valves have to be disconnected from the mains supply in an emergency situation, these can also be supplied via a separate connection. There is a choice of two versions of valve terminals for A/B mode.

The valve terminal with AS-Interface is available in the following versions:

- Without inputs, with two or four valve slices (max. 4 solenoid coils) with additional power supply
- With four inputs and four valve slices (max. 8 solenoid coils)
- With four or eight inputs and four or eight valve slices (max. 8 solenoid coils) and additional power supply

- With four or eight inputs and four or eight valve slices incl. vacant position or vacant positions and additional power supply (max. 6 solenoid coils for A/B mode in accordance with SPEC.2.1, max. 8 solenoid coils for A/B mode in accordance with SPEC. 3.0 with Profile 7.A.7)

More information

→ Internet: [as-interface](#)

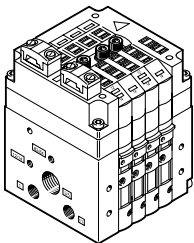

For valve terminals CPV10, CPV14 or CPV18, use the configuration value "EX1E" for the "EU certification" feature and code "AS", "AZ", "AE" or "AO" for the feature "Electrical connection".



Note

Valve terminals to SPEC.2.1 cannot be operated on a master to SPEC.3.0 with profile 7.A.7.

Selection and development

Electrical connections

I-Port interface/IO-Link®, CTEL installation system

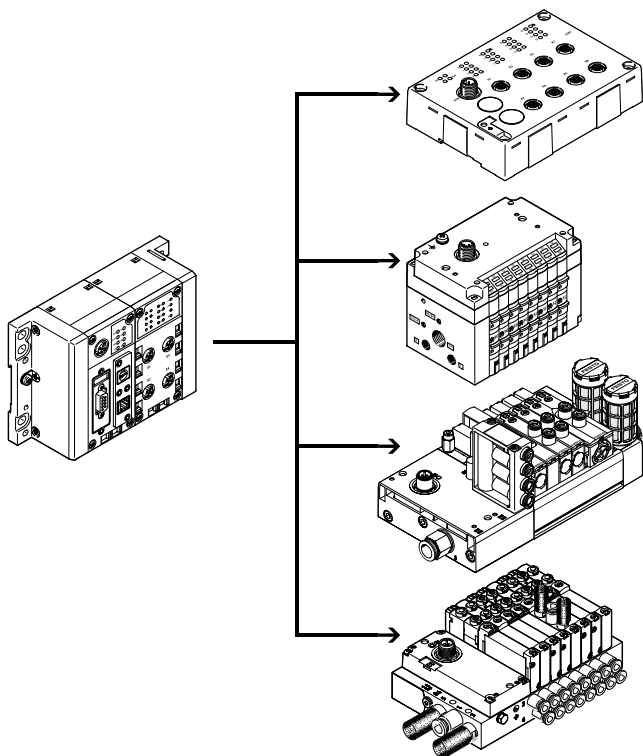

A CTEL system consists of the CTEL master and the devices with I-Port interface, which are connected using special connecting cables. This permits a decentralised layout of the devices. This means that the valve terminals and I/O modules with I-Port interface (devices) can be mounted very close to the cylinders to be controlled. This reduces the length of the air supply lines used, which in turn minimises flow losses as well as pressurisation and exhaust times.

The I-Port interface from Festo is based on IO-Link® and is therefore compatible with IO-Link® in certain areas. The connection type corresponds to a star topology. In other words, only one module or one valve terminal can be connected to each I-Port.

As well as transmitting the communication data, the I-Port interfaces also handle the power supply for the connected devices.

The maximum length of a string is 20 m.

The restrictions compared to IO-Link® include:

- Permanently set baud rate of 230.4 kbps
- SIO mode is not supported
- Max. 32 bytes of input data and 32 bytes of output data
- Only one extract of the master commands is used
- Festo plug & work principle, configuration via IODD is not supported.

More information

→ Internet: cteu

→ Internet: cpx



Connection via the I-Port master module of an electrical terminal CPX.

For valve terminals CPV10 or CPV14, use the configuration value "EX1E" for the "EU certification" feature and "PT" for the feature "Electrical connection".

For the electrical terminal CPX, use the configuration value "EX1E" for the feature "EU certification".

Selection and development

I-Port interface/IO-Link®, CTEU system

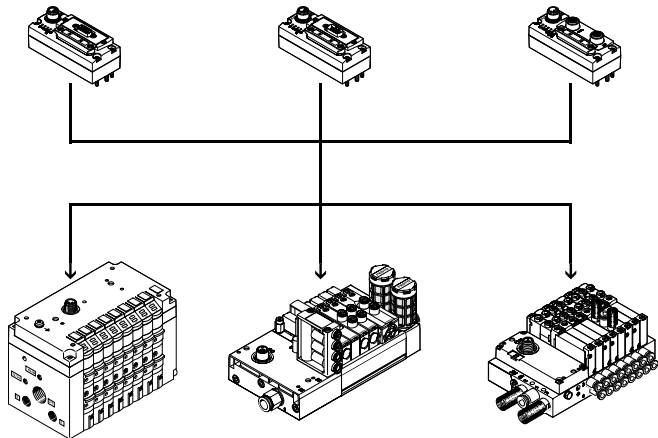

CTEU is a system for the compact connection of a valve terminal to different fieldbus standards such as PROFIBUS and DeviceNet®.

The bus node is mounted directly on the I-Port interface of the valve terminal.

This makes it easier to switch between the fieldbus protocols than with Fieldbus Direct; however, there is no way of connecting I/O modules to the bus node (as with the CPI string extension).

The following fieldbus protocols are supported:

- CANopen
- DeviceNet®
- CC-LINK®
- PROFIBUS
- EtherCAT®
- AS-Interface
- PROFINET
- EtherNet/IP
- VARAN

More information

→ Internet: cteu

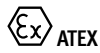

Connection via I-Port (code: PT).

For valve terminals CPV10 or CPV14, use the configuration value "EX1E" for the "EU certification" feature and "PT" for the feature "Electrical connection".

- Note

Please note that the directly mounted bus node CTEU must be ordered separately and only the following versions are permitted:

- 8107588
CTEU-PB-EX1C
- 8107589
CTEU-PN-EX1C
- 8107591
CTEU-EP-EX1C

Key features

Electrical connections

Installation system CP/CPI

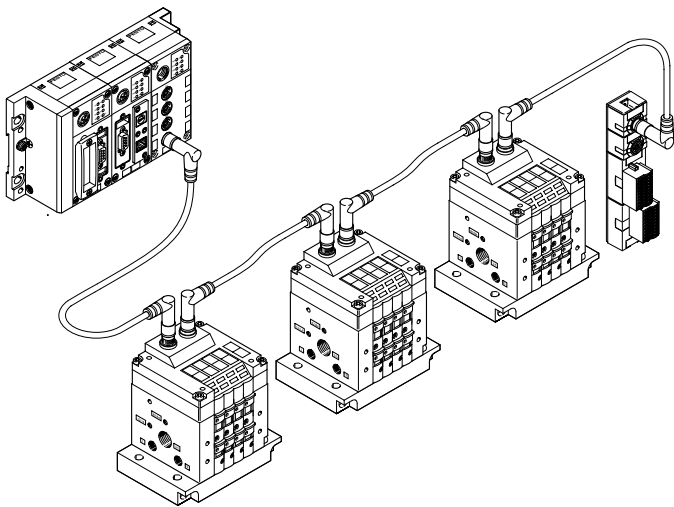

The installation system CP/CPI comprises an interface for connecting valve terminals and I/O modules with CP connection to the modular electrical terminal CPX.

All CP valve terminals and CP modules are connected using a ready-to-install CP cable, and are attached to the CP interface. In each case 4 modules, for example one valve terminal CPV and one to three CP input modules, make up an installation string that ends at the CP interface.

Scope of services:

- Max. 4 installation strings per CP interface
- Max. 10 metre line length per string (radius)
- Max. 4 CP modules per string
- Max. 32 inputs and max. 32 outputs per string

The following bus protocols are supported:

- PROFIBUS DP
- DeviceNet®
- CANopen
- CC-LINK®
- EtherNet/IP
- PROFINET
- POWERLINK
- EtherCAT®
- Sercos III

In the installation system CP/CPI, the valve terminal CPV is treated as an output module having up to 8 outputs (4, 6 or 8 valve slices or 4 to 16 solenoid coils per terminal). The connecting cables transfer all the required electrical signals (control signals, operating voltage for the internal electronics of the modules, load voltage supply for connected valves).

More information

→ Internet: cpi



For valve terminals CPV10 or CPV14, use the configuration value "EX1E" for the "EU certification" feature and "FB" for the feature "Electrical connection".

Fieldbus Direct

Fieldbus Direct is a system for the compact connection of a CPV Profibus DP valve terminal to different fieldbus standards.

The bus node is directly integrated in the electrical control of the valve terminal

and therefore takes up only a minimal amount of space. The CPI string extension option enables the functions and components of the system CPI to be used.

The new high-performance CPI string extension offers up to 4 supplementary CPI modules in a mix with CP- or CPI-compatible valve terminals for extension. It is possible to extend the Fieldbus Direct system from 8 ... 32 in-

puts and 8 ... 32 outputs without any problems.



For valve terminals CPV10 or CPV14, use the configuration value "EX1E" for the "EU certification" feature and "D1" or "D2" for the feature "Electrical connection".

Selection and development

Valve terminal configurator

→ Internet: www.festo.com

General

A valve terminal configurator is available to help you select a suitable valve terminal, making it much easier to order the right product.

The valve terminals are assembled according to your order specification and are individually checked. This reduces assembly and installation time to a minimum.

CPV10-VI

Order a valve terminal CPV10-VI using the order code:

Ordering system CPV10
→ Internet: cpv10

CPV14-VI

Order a valve terminal CPV14-VI using the order code:

Ordering system CPV14
→ Internet: cpv14

CPV18-VI

Order a valve terminal CPV18-VI using the order code:

Ordering system CPV18
→ Internet: cpv18

Ordering data – Product options

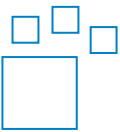

Configurable product

This product and all its product options can be ordered using the configurator.

The configurator can be found at

→ www.festo.com/catalogue/cpv

Enter the part number or the type.

Part no.

18200

18210

18220

Type

CPV10-VI

CPV14-VI

CPV18-VI

Peripherals overview

Overview – CPV valve terminal

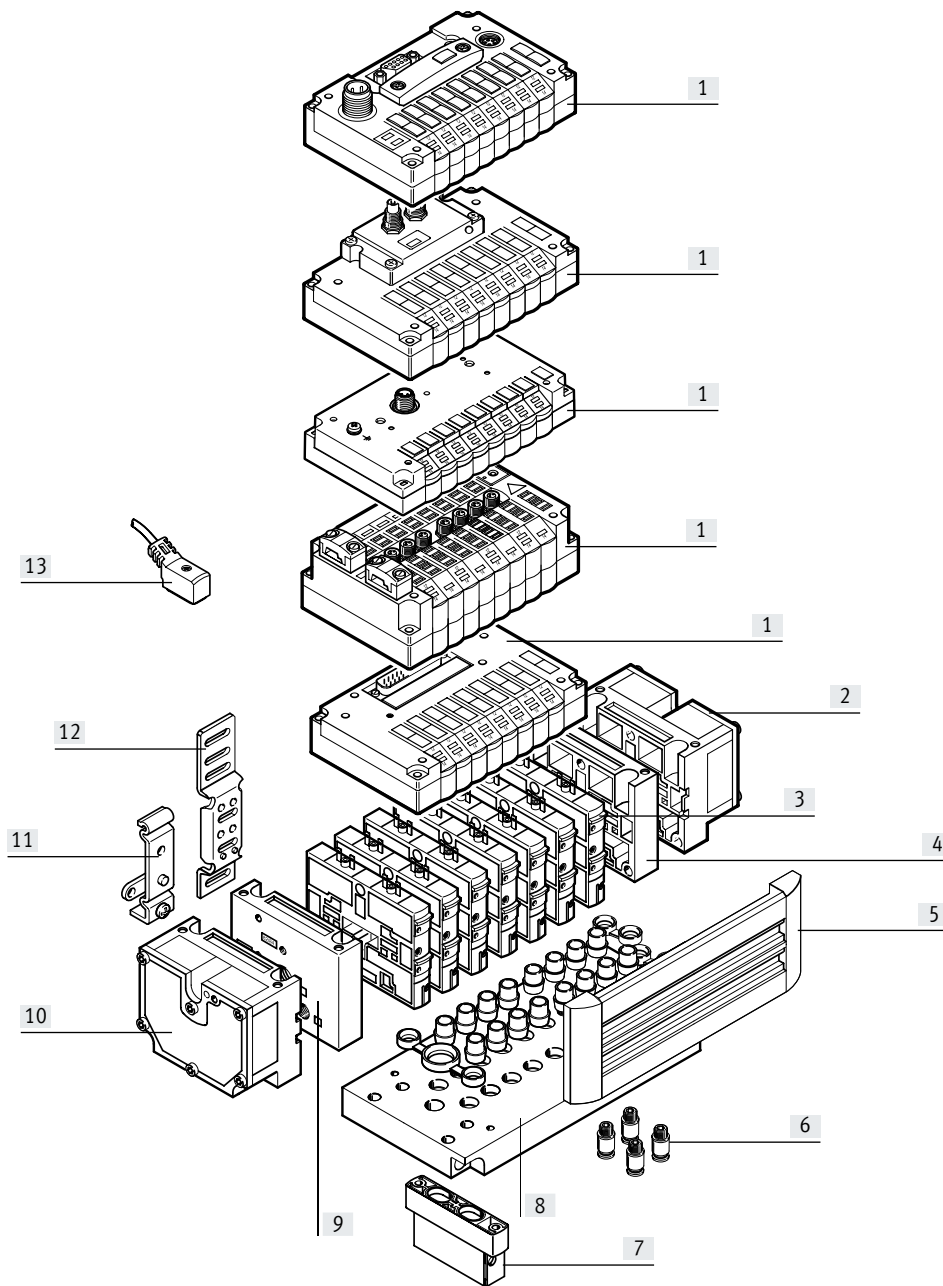

- | | | | |
|--|---|--|---|
| [1] Basic electrical unit (Fieldbus Direct, installation system CP/CPI, I-Port interface/IO-Link®, AS-Interface, multi-pin, individual connection) | [3] Comprehensive range of valve functions | [7] Functional module (vertical stacking) | [10] Left end plate with flat plate silencer |
| [2] Right end plate with flat plate silencer | [4] Right end plate (threaded connections not in combination with pneumatic multiple connector plate) | [8] Pneumatic multiple connector plate | [11] H-rail mounting |
| | [5] Inscription label holder | [9] Left end plate (threaded connections not in combination with pneumatic multiple connector plate) | [12] Wall mounting |
| | [6] QS push-in fittings | | [13] Connecting cable for individual connection |

Key features – Pneumatic components

Valves

Valves CPV are valves with an integrated sub-base, i.e. in addition to the valve function they also include all pneumatic ducts for supply, exhaust and for the working ports. The supply ducts are the central component of the valve slices and enable a direct flow through the valve slices so that maxi-

mum flow rates can be achieved. All valves have a pneumatic pilot control for optimising performance. The valve function is based on a piston spool valve system with patented sealing principle, ensuring a broad range of applications and long service life.

The components for the pneumatics and the pneumatic functions are always the same for all types of control. Most functions are also available in the different valve sizes (grid dimension). Restrictions are pointed out where applicable.

Valve function		Size			Description
Code	Circuit symbol	10	14	18	
M, MK		■	■	■	5/2-way valve, single solenoid <ul style="list-style-type: none"> • Pneumatic spring return • Piston spool valve • With duct separation 1, 11 for valve MK • Size 18 only available for valve M
F		■	-	-	5/2-way valve, single solenoid <ul style="list-style-type: none"> • Pneumatic spring return • Piston spool valve • Fast switching
J, JK		■	■	■	5/2-way valve, double solenoid <ul style="list-style-type: none"> • Piston spool valve • With duct separation 1, 11 for valve JK • Size 18 only available for valve J
C, CK		■	■	■	2x 3/2-way valve, single solenoid <ul style="list-style-type: none"> • Normally closed • Pneumatic spring return • Piston spool valve • With duct separation 1, 11 for valve CK • Size 18 only available for valve C
CY		■	-	-	2x 3/2-way valve, single solenoid <ul style="list-style-type: none"> • Normally closed • Pneumatic spring return • Integrated back pressure protection • Piston spool valve • Not suitable for vacuum <p>Note</p> <p>If it is necessary to ensure that the back pressure flaps are securely closed in the event of a sudden loss or shutdown of the operating pressure, the valve terminal must be operated with external pilot air supply.</p>

Key features – Pneumatic components

Valve function		Size			Description
Code	Circuit symbol	10	14	18	
N, NK		■	■	■	<p>2x 3/2-way valve, single solenoid</p> <ul style="list-style-type: none"> • Normally open • Pneumatic spring return • Piston spool valve • With duct separation 1, 11 for valve NK • Size 18 only available for valve N <p>By using these valves in the open initial position, the function of a 5/3-way valve with mid-position pressurised can be achieved</p>
H, HK		■	■	■	<p>2x 3/2-way valve, single solenoid</p> <ul style="list-style-type: none"> • Normal position <ul style="list-style-type: none"> – 1x open (pilot control 12) – 1x closed (pilot control 14) • Pneumatic spring return • Piston spool valve • With duct separation 1, 11 for valve HK • Size 18 only available for valve H <p>For optimised cylinder movement. With simultaneous actuation of both solenoid coils, corresponds to valve function M (5/2-way, single solenoid). As each side of the piston surface can be pressurised or exhausted independently from each other, the cylinder can execute faster movements.</p>
G		-	-	■	<p>5/3-way valve, mid-position closed</p> <ul style="list-style-type: none"> • Mechanical spring return • Piston spool valve
-	-	■	■	-	<p>5/3G¹⁾ function, mid-position closed for size 10 and 14.</p> <p>The valve function "mid-position closed" is created using a 2x 3/2-way valve, normally closed (code C).</p> <p>The valve kit CPV10-BS-5/3G-M7 or CPV14-BS-5/3G-1/8 (incorporating a double piloted check valve function) is used for this. The valve kit is intended for use with one working pressure for each valve slice, i.e. it must not be used in dual-pressure operation (different pressure at port 1 and 11).</p> <p>If other valve slices are used in dual-pressure operation, a separator plate must be used to separate the valve slice equipped with the 5/3G valve kit from the compressed air duct 1 and 11 (code T).</p> <p>With pneumatic multiple connector plate P and M, not in the first or last valve position. Cannot be used with pneumatic multiple connector plate GQC and GQD.</p> <ul style="list-style-type: none"> • Piston spool valve

1) Cannot be installed in combination with the pneumatic multiple connector plate for control cabinets CPV10-VI-P...-C or CPV10-VI-P...-D

Note

A filter must be installed upstream of valves operated in vacuum mode. This prevents any foreign matter in the intake air getting into the valve (e.g. when operating a suction cup).

Key features – Pneumatic components

Valve function		Size			Description
Code	Circuit symbol	10	14	18	
-		■	■	■	5/3E function, mid-position exhausted The valve function "mid-position exhausted" is created using a 2x 3/2-way valve, normally closed (code C, CK). <ul style="list-style-type: none"> • Pneumatic spring return • Piston spool valve
-		■	■	■	5/3B function, mid-position pressurised The valve function "mid-position pressurised" is created using a 2x 3/2-way valve, normally open (code N, NK). <ul style="list-style-type: none"> • Pneumatic spring return • Piston spool valve
D, DK		■	■	■	2x 2/2-way valve, single solenoid <ul style="list-style-type: none"> • Normally closed • Pneumatic spring return • Piston spool valve • With duct separation 1, 11 for valve DK • Size 18 only available for valve D
I, IK		■	■	■	2x 2/2-way valve, single solenoid <ul style="list-style-type: none"> • Normal position <ul style="list-style-type: none"> - 1x open (control side 12) - 1x closed (control side 14) • Pneumatic spring return • Piston spool valve • With duct separation 1, 11 for valve IK • Size 18 only available for valve I

Key features – Pneumatic components

Additional pneumatic functions		Size			Description
Code	Circuit symbol	10	14	18	
A	<p>Vacuum generator</p>	■	■	■	<p>Vacuum generation according to the ejector principle. Vacuum slices of different widths for different suction capacities. Combinations with a number of vacuum and/or directional control discs are possible on the same valve terminal. The principle consists of an open connection between the exhaust duct 3/5 and the working port 4. If a nozzle is not connected, any back pressure that occurs in the exhaust duct flows back into the working port. If a nozzle is connected, the vacuum can be reduced using the back pressure.</p>
E	<p>Vacuum generator with ejector pulse</p>	■	■	■	<p>This effect is improved by optimising the exhaust. With just one vacuum generator per valve terminal and separation using the separator plate (code S), the effect does not occur. Vacuum generator on pilot side 14 <ul style="list-style-type: none"> Reset via mechanical spring and pneumatic spring Ejector pulse on pilot side 12 (code E) With more than two vacuum generators, pay attention to the air supply and exhaust </p>
P	<p>Input (valve side)</p> <p>Output (cylinder side)</p>	■	■	-	<p>2x one-way flow control valve, supply air flow control Module (attachment) for direct flange connection to the valves CPV. Also suitable for pneumatic multiple connector plate. It is not possible to combine different valve attachments. Not with valve function G <ul style="list-style-type: none"> Not in the first or last valve position with accessories M, P, V (pneumatic multiple connector plate) Cannot be used with accessories GQC or GQD (pneumatic multiple connector plate) </p>
Q	<p>Input (valve side)</p> <p>Output (cylinder side)</p>	■	■	-	<p>2x one-way flow control valve, exhaust air flow control Module (attachment) for direct flange connection to the valves CPV. Also suitable for pneumatic multiple connector plate. It is not possible to combine different valve attachments. <ul style="list-style-type: none"> Not with valve function G Not in the first or last valve position with accessories M, P, V (pneumatic multiple connector plate) Cannot be used with accessories GQC or GQD (pneumatic multiple connector plate) </p>
V	<p>Input (valve side)</p> <p>Output (cylinder side)</p>	■	■	-	<p>One-way flow control valve for vacuum The module CPV-...-BS-GRZ-V-... has a built-in check valve as well as a throttle function for adjusting the ejector pulse. The check valve temporarily maintains the vacuum, even if the vacuum generator is switched off. The module is suitable for vacuum generators (code A, E). <ul style="list-style-type: none"> Not in the first or last valve position with accessories M, P, V (pneumatic multiple connector plate) Cannot be used with accessories GQC or GQD (pneumatic multiple connector plate) </p>

Key features – Pneumatic components

Creating pressure zones



Two pressure levels per valve are created using different pressure at port 1 and 11. Thus, for example, a cylinder drive can be advanced with high pressure and retracted with low pressure to save energy.

The maximum possible number of pressure zones is determined by the combination of the following components:

- Use of a separator plate
- Type of end plate pair

- Valve slice type
 - Number of valve slices
- separator plates or valves with integrated duct separation.

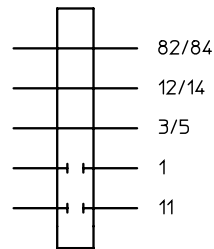
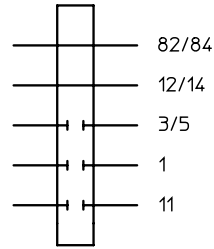
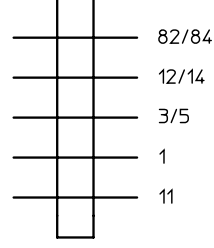
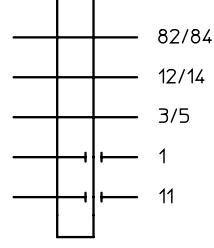
The valve terminal CPV can be divided into 2 to 4 pressure zones using sep-

Separator plates/valves with integrated duct separation					
Code	Illustration	Size			Note
		10	14	18	
T	<p>Separator plate for creating pressure zones, supply duct 1 and 11 are separate</p> 	■	■	■	<p>Using one separator plate (code T), only the air supply duct (port 1 and 11) is interrupted to allow two pressure levels.</p> <ul style="list-style-type: none"> • Not in the first or last valve position • Not with compressed air supply A, B, C, D, U, V, W, X
S	<p>Separator plate for creating pressure zones, supply duct 1, 11 and exhaust 3, 5 are separate</p> 	■	■	■	<p>The separator plate (code S) divides the exhaust duct 3/5 as well as the supply duct 1 and 11. This plate should be used if one of the pressure zones is a vacuum, to prevent any effect on the vacuum or to prevent back pressures on adjacent valve functions.</p> <ul style="list-style-type: none"> • Not in the first or last valve position • Not with compressed air supply A, B, C, D, U, V, W, X • (compressed air supply on one side)
L	<p>Blanking plate (vacant position)</p> 	■	■	■	<p>A blanking plate (code L) is used to provide a vacant position at which a valve can be inserted later.</p>
MK, JK, CK, NK, DK, IK	<p>Valve with integrated separation of ducts 1 and 11</p> 	■	■	-	<p>With these valves, the air supply ducts (port 1 and 11) are sealed by a casting skin to the right of the valve. Compared with using a separator plate, this has the advantage that none of the valve positions is occupied by a separator plate.</p> <p> Note</p> <p>Where internal pilot air via the right end plate is used as the compressed air supply, at least one further valve with the code M, F, J, C, CY, N, H, G, D, I, A or E must be used directly to the right of this valve.</p>

Key features – Pneumatic components

Examples: Pneumatic supply

External pilot air supply, flat plate silencer at both ends

Compressed air supply via pneumatic multiple connector plate:

Code H

The diagram on the right shows an example of the configuration and connection of the compressed air supply with external pilot air supply. Port 12/14 on the pneumatic multiple connector plate is equipped with a fitting for this. Exhaust ports 3/5 and 82/84 are exhausted via the flat plate silencers.

A separating seal each can be optionally used to create pressure zones.

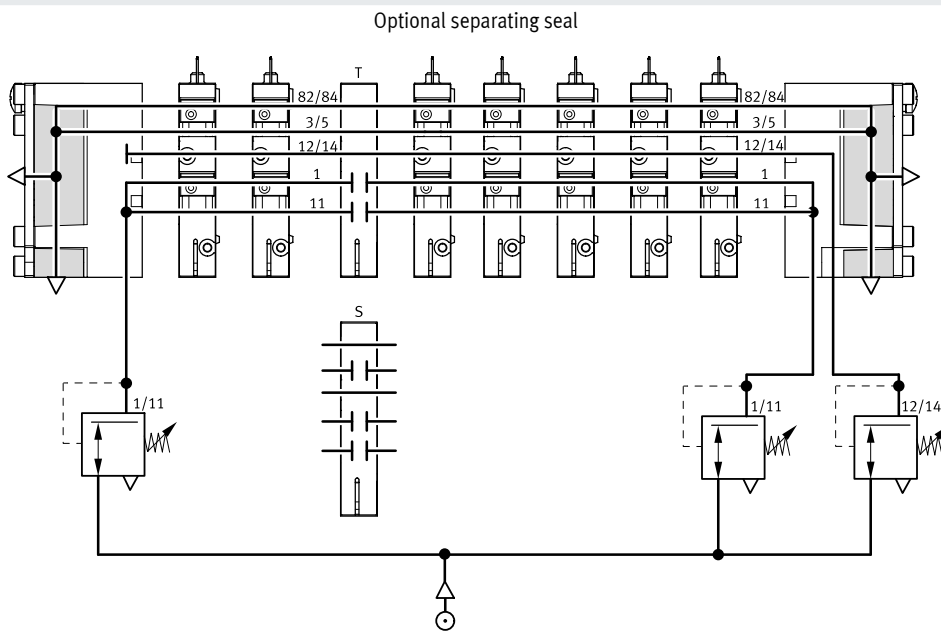

Internal pilot air supply, ducted exhaust air or threaded silencer

Compressed air supply via end plates:

Code Z

The diagram on the right shows an example of the configuration and connection of the compressed air supply with internal pilot air supply.

The pilot air is branched at the right end plate of port 1 or 11. The exhaust 3/5 and 82/84 is expelled via the threaded silencer.

A separating seal each can be optionally used to create pressure zones.

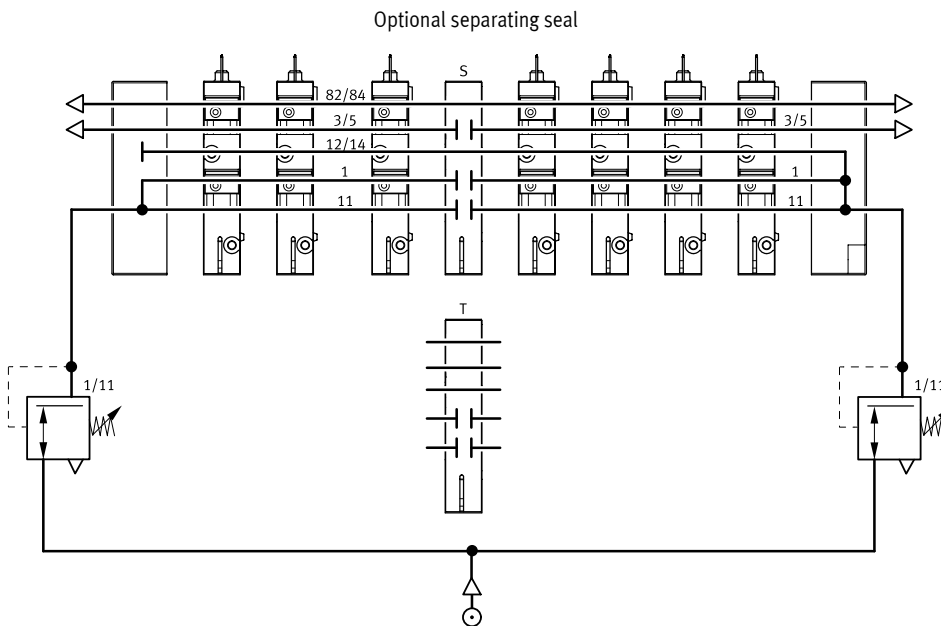

Key features – Pneumatic components

Examples: Creating pressure zones

CPV with separator plate T

Up to 4 pressure zones can be created on the valve terminals CPV. The diagram shows an example of the configuration and connection of four pressure zones using separator plate code T – with external pilot air supply.

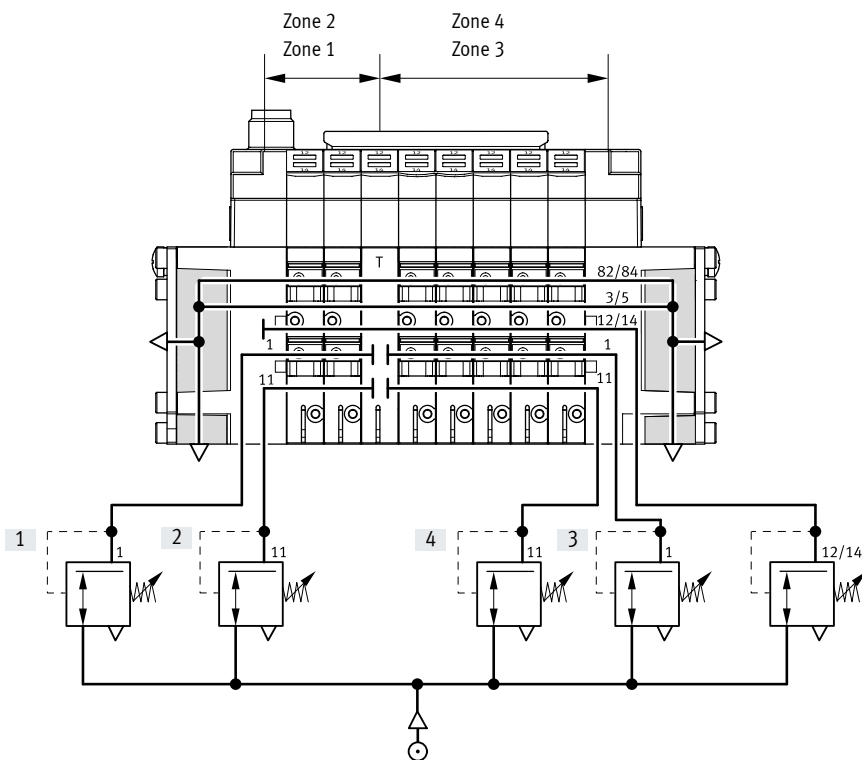

- | | |
|---------------------|--------------------------|
| [1] Vacuum –0.9 bar | [3] Forward stroke 6 bar |
| [2] Air pulse 2 bar | [4] Return stroke 4 bar |

CPV with integrated separation of duct 1 and 11 in valves ...K

Up to 4 pressure zones can be created on the valve terminals CPV. The diagram shows an example of the configuration and connection of four pressure zones with external pilot air supply and the use of a valve ...K with integrated separation of ducts 1 and 11.

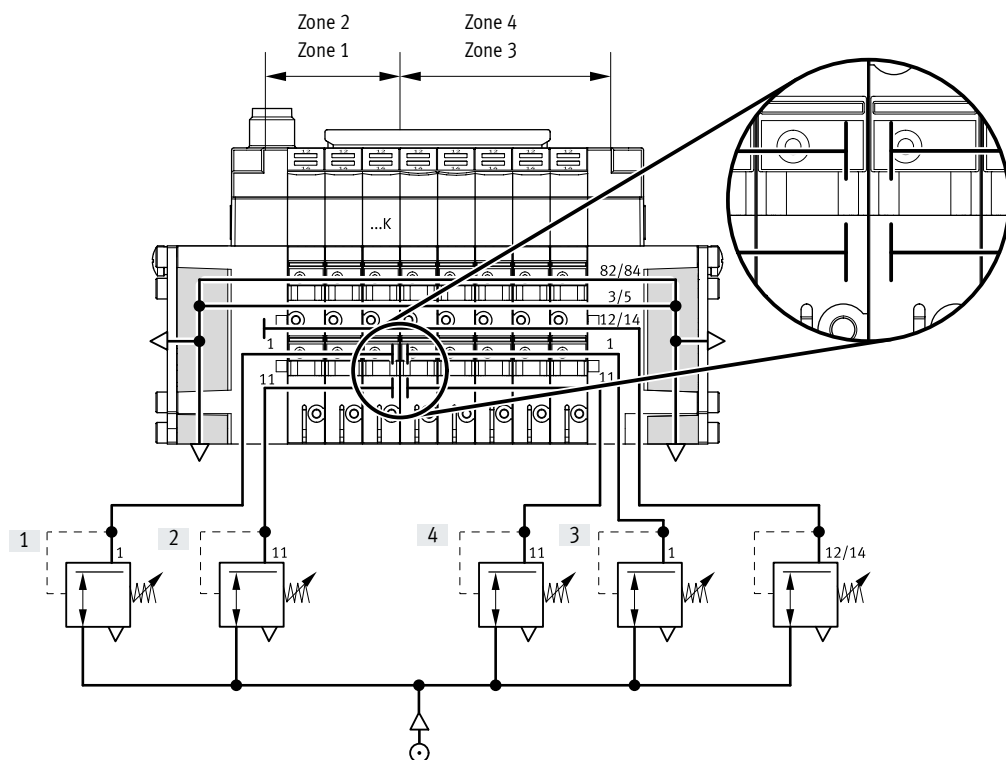

- | | |
|---------------------|--------------------------|
| [1] Vacuum –0.9 bar | [3] Forward stroke 6 bar |
| [2] Air pulse 2 bar | [4] Return stroke 4 bar |

Key features – Pneumatic components

Compressed air supply and exhaust

A characteristic feature of a valve terminal CPV is the two end plates which supply the valve slices with pressure and exhaust them.

- Large duct cross sections enable very high flow rate performance, even with several valves switching simultaneously

- Large flat plate silencers in the end plates
- Internal/external pilot air supply

Each individual valve is supplied with compressed air from two individual ducts (supply ports 1/11) and exhausted via a large integrated exhaust duct (exhaust 3/5). This design allows

unique functionality and flexibility, making it very easy to have multiple pressure zones per terminal or combinations of vacuum applications.

The valve terminal is supplied via end plates, either on the left, on the right or on both sides. End plate combinations other than those listed are possible (on request).

Pilot air supply

Internal pilot air supply

This can be selected if the supply pressure at pneumatic port 1 is 0.3 ... 0.8 MPa. With internal pilot air supply, the branch is located in the left or right end plate. There is no port 12/14.

External pilot air supply

External pilot air supply is required if the supply pressure at pneumatic port 1 is lower than 0.3 MPa or higher than 0.8 MPa. In this case, a pressure of 0.3 ... 0.8 MPa is applied at port 12/14.

If a gradual pressure build-up in the system using a soft-start valve is required, an external pilot air supply

should be selected. In this case, the control pressure applied during switch-on is already very high.

External pilot air supply is also required if it is necessary to ensure that the back pressure valves (valve order code CY) are securely closed in the event of a sudden loss or shutdown of the operating pressure.

End plates

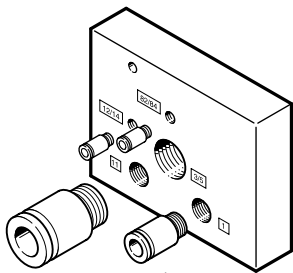

Example of an end plate:

The diagram shows a left end plate with external pilot air supply. The exhaust ports 3/5 and 82/84 can be equipped with fittings or silencers. An end plate for internal pilot air supply does not have ports 12/14 and 11. Port 82/84 is always present and should be fitted with a silencer. With an end plate for internal pilot air supply,

port 12/14 is connected internally to port 1.

Key features – Pneumatic components

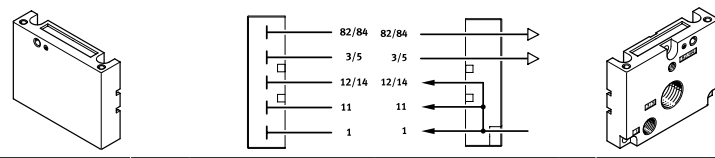
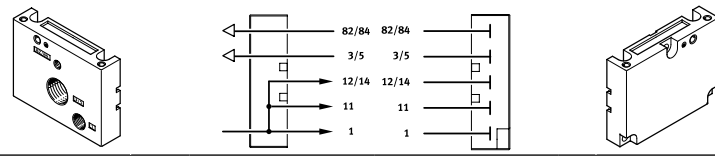
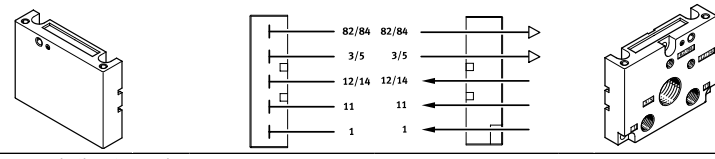
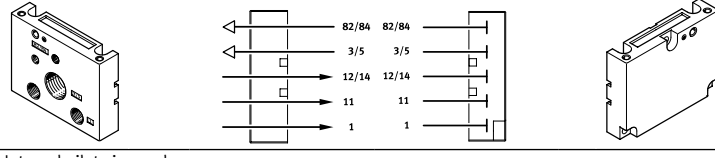
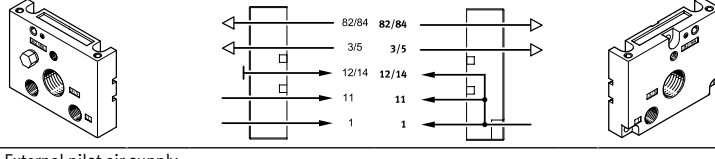
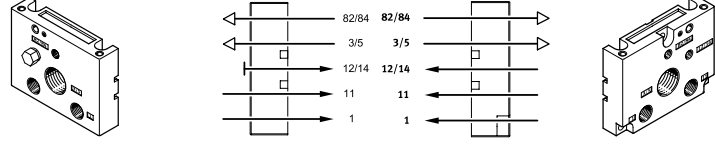
End plate combination for compressed air supply via end plate		Size			Note
Code	Illustration Type of pilot air supply (internal/external)	10	14	18	
U	Internal pilot air supply 	■	■	■	<ul style="list-style-type: none"> Ports in right end plate only No pressure zone separation permissible Not suitable for vacuum
V	Internal pilot air supply 	■	■	■	<ul style="list-style-type: none"> Ports in left end plate only No pressure zone separation permissible Not suitable for vacuum
W	External pilot air supply 	■	■	■	<ul style="list-style-type: none"> Ports in right end plate only No pressure zone separation permissible Suitable for vacuum
X	External pilot air supply 	■	■	■	<ul style="list-style-type: none"> Ports in left end plate only No pressure zone separation permissible Suitable for vacuum
Y	Internal pilot air supply 	■	■	■	<ul style="list-style-type: none"> Ports in left and right end plate Maximum three pressure zones Valves on the left of the separator plate suitable for vacuum
Z	External pilot air supply 	■	■	■	<ul style="list-style-type: none"> Ports in left and right end plate Maximum four pressure zones Suitable for vacuum

Key features – Pneumatic components

End plate combination for compressed air supply via pneumatic multiple connector plate					
Code	Illustration Type of pilot air supply (internal/external)	Size			Note
		10	14	18	
Y	Internal pilot air supply 	■	■	■	<ul style="list-style-type: none"> Ports on pneumatic multiple connector plate Pressure zone separation only permissible with separator plate (code T) Maximum two pressure zones Valves on the left of the separator plate suitable for vacuum Only for accessories M, P, V, GQC, GQE, QGD (pneumatic multiple connector plate)
Z	External pilot air supply 	■	■	■	<ul style="list-style-type: none"> Ports on pneumatic multiple connector plate Pressure zone separation only permissible with separator plate (code T) Maximum three pressure zones Suitable for vacuum Only for accessories M, P, V, GQC, GQE, QGD (pneumatic multiple connector plate)

End plate combination for compressed air supply via end plate with flat plate silencer					
Code	Illustration Type of pilot air supply (internal/external)	Size			Note
		10	14	18	
A	Internal pilot air supply 	■	■	■	<ul style="list-style-type: none"> Ports in right end plate No pressure zone separation permissible Not suitable for vacuum
B	Internal pilot air supply 	■	■	■	<ul style="list-style-type: none"> Ports in left end plate No pressure zone separation permissible Not suitable for vacuum
C	External pilot air supply 	■	■	■	<ul style="list-style-type: none"> Ports in right end plate No pressure zone separation permissible Suitable for vacuum
D	External pilot air supply 	■	■	■	<ul style="list-style-type: none"> Ports in left end plate No pressure zone separation permissible Suitable for vacuum

Key features – Pneumatic components

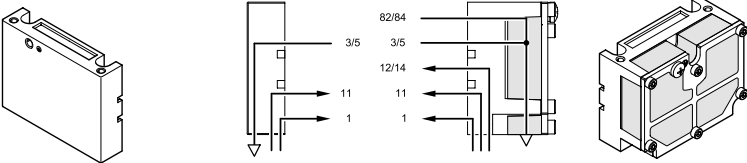
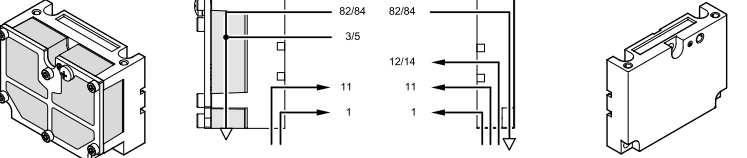
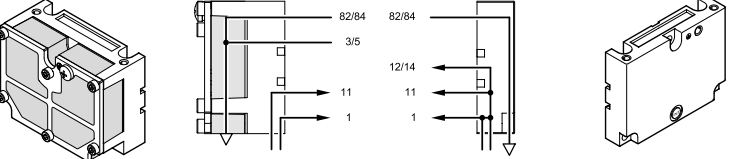
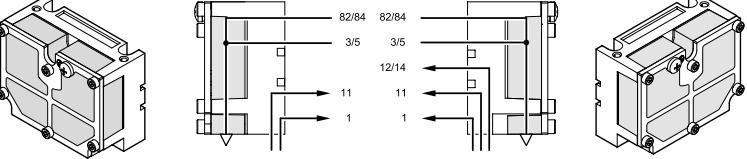
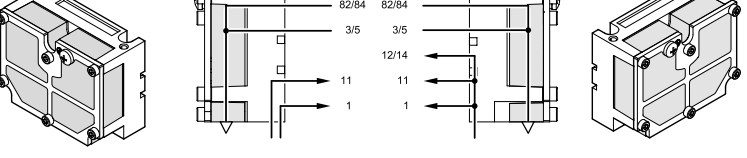
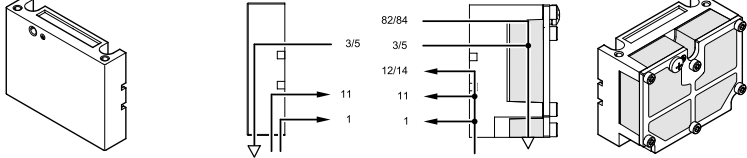
End plate combination for compressed air supply via pneumatic multiple connector plate with flat plate silencer		Size			Note
Code	Illustration Type of pilot air supply (internal/external)	10	14	18	
E	External pilot air supply 	■	■	■	<ul style="list-style-type: none"> Ports on pneumatic multiple connector plate Exhaust air vented via flat plate silencer on the right Pressure zone separation only permissible with separator plate (code T) Maximum four pressure zones Suitable for vacuum Only for accessories M, P, V, GQC, GQE, GQD (pneumatic multiple connector plate)
F	External pilot air supply 	■	■	■	<ul style="list-style-type: none"> Ports on pneumatic multiple connector plate Exhaust air vented via flat plate silencer on the left Pressure zone separation only permissible with separator plate (code T) Maximum four pressure zones Suitable for vacuum Only for accessories M, P, V, GQC, GQE, GQD (pneumatic multiple connector plate)
G	Internal pilot air supply 	■	■	■	<ul style="list-style-type: none"> Ports on pneumatic multiple connector plate Exhaust air vented via flat plate silencer on the left Pressure zone separation only permissible with separator plate (code T) Maximum three pressure zones Not suitable for vacuum Only for accessories M, P, V, GQC, GQE, GQD (pneumatic multiple connector plate)
H	External pilot air supply 	■	■	■	<ul style="list-style-type: none"> Ports on pneumatic multiple connector plate Exhaust air vented via flat plate silencers at both ends Pressure zone separation permissible Suitable for vacuum Only for accessories M, P, V, GQC, GQE, GQD (pneumatic multiple connector plate)
J	Internal pilot air supply 	■	■	■	<ul style="list-style-type: none"> Ports on pneumatic multiple connector plate Exhaust air vented via flat plate silencers at both ends Pressure zone separation permissible Maximum three pressure zones Valves on the left of the separator plate suitable for vacuum Only for accessories M, P, V, GQC, GQE, GQD (pneumatic multiple connector plate)
K	Internal pilot air supply 	■	■	■	<ul style="list-style-type: none"> Ports on pneumatic multiple connector plate Exhaust air vented via flat plate silencer on the right Pressure zone separation permissible Maximum three pressure zones Suitable for vacuum in combination with separator plate Only for accessories M, P, V, GQC, GQE, GQD (pneumatic multiple connector plate)

Key features – Pneumatic components

Pneumatic connection

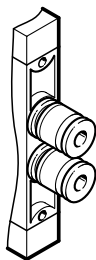

The working lines are located directly in the valve slices.
Threaded connections and Quick Star push-in fittings (QS) are available for different tubing sizes.
The supply ports are located in the end plates or in the pneumatic multiple connector plate.

Push-in fittings are available fully assembled.

The following working lines can be selected:

- Push-in fittings, large: code A
- Push-in fittings, small: code B
- Threaded connections: code C

Connection sizes for threads and QS push-in fittings can be found in the table below.

Pneumatic multiple connector plate

One-piece sub-bases are available for use with a pneumatic multiple connector plate; these contain both the working ports and also the supply ports. This allows the valve terminal as a pneumatic "function" to be separated from the ports.

The pneumatic multiple connector plate enables different types of mounting, from wall mounting to direct attachment through a housing wall.

Easy-to-service and flexible connection technology thanks to:

- Common connection via the pneumatic multiple connector plate with all connections on one side

- For mounting/dismounting, the valve terminal is secured/released using just four screws while the pneumatic tubing remains connected
- Minimal time required for mounting/dismounting
- No faults during recommissioning caused by incorrectly connected tubing

CPV valve terminal

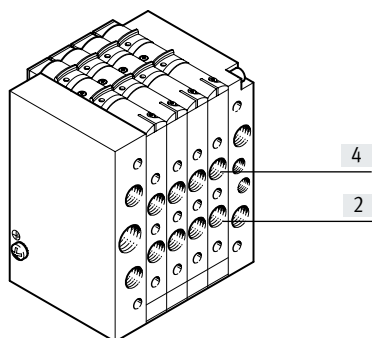

Pneumatic multiple connector plate

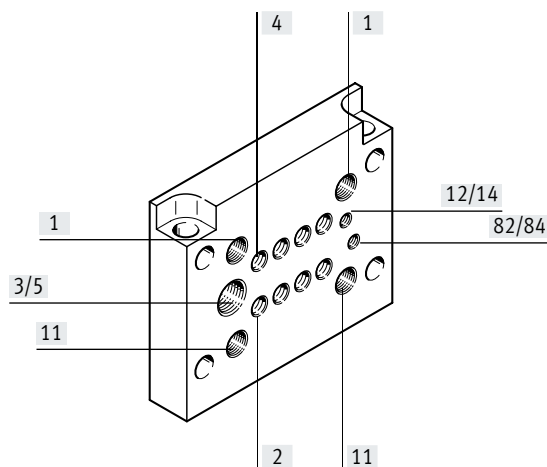



Connection sizes

Connection to ISO 5599	CPV10	CPV14	CPV18	Comment
1/11 Supply air	G1/8	G1/4	G3/8	Fitting in end plate or pneumatic multiple connector plate
2/4 Working port	M7 (QS6/QS4)	G1/8 (QS8/QS6)	G1/4 (QS10/QS8)	Port in valve slice, push-in fitting via clips
3/5 Exhaust air port	G3/8	G1/2	G1/2	Via right/left end plate
	G1/4	G3/8	G1/2	Pneumatic multiple connector plate
12/14 Pilot air supply port	M5	G1/8	G1/4	Fitting in end plate or pneumatic multiple connector plate
82/84 Pilot exhaust air port	M5	G1/8	G1/4	Via right/left end plate
	M7 (M5) ¹⁾	G1/8	G1/4	Pneumatic multiple connector plate

1) With pneumatic multiple connector plate with flange

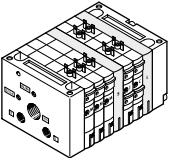
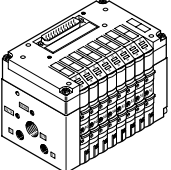
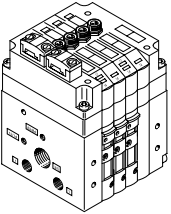
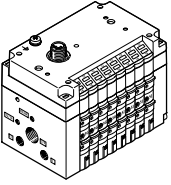
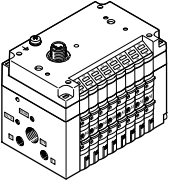
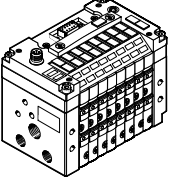
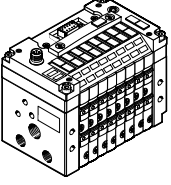
Key features – Pneumatic components

Pneumatic connection: fitting set for compressed air supply						
Code Compressed air supply	Connection	Designation	Size 10	Size 14	Size 18	
			QS6 Type	QS8 Type	QS10 Type	
Without pneumatic multiple connector plate						
	U, V	82/84	Silencer	AMTE-M-LH-M5	AMTE-M-LH-G18	AMTE-M-LH-G14
		3/5	Silencer	AMTE-M-LH-G38	AMTE-M-LH-G12	AMTE-M-LH-G12
		1	Push-in fitting	QS-G1/8-8-I	QS-G1/4-10-I	QS-G3/8-12-I
	W, X	82/84	Silencer	AMTE-M-LH-M5	AMTE-M-LH-G18	AMTE-M-LH-G14
		3/5	Silencer	AMTE-M-LH-G38	AMTE-M-LH-G12	AMTE-M-LH-G12
		1	Push-in fitting	QS-G1/8-8-I	QS-G1/4-10-I	QS-G3/8-12-I
		12/14	Push-in fitting	QSM-M5-6-I	QS-G1/8-8-I	QS-G1/4-10-I
	Y	82/84 on right	Silencer	AMTE-M-LH-M5	AMTE-M-LH-G18	AMTE-M-LH-G12
		82/84 on left	Blanking plug	B-M5	B-1/8	B-1/4
		3/5 on right	Silencer	AMTE-M-LH-G38	AMTE-M-LH-G12	AMTE-M-LH-G12
		3/5 on left	Blanking plug	B-3/8	B-1/2	B-1/2
		1/11 on left	Push-in fitting	QS-G1/8-8-I	QS-G1/4-10-I	QS-G3/8-12-I
	Z	82/84 on right	Silencer	AMTE-M-LH-M5	AMTE-M-LH-G18	AMTE-M-LH-G12
		82/84 on left	Blanking plug	B-M5	B-1/8	B-1/4
		3/5 on right	Silencer	AMTE-M-LH-G38	AMTE-M-LH-G12	AMTE-M-LH-G12
		3/5 on left	Blanking plug	B-3/8	B-1/2	B-1/2
		12/14 on right	Push-in fitting	QSM-M5-6-I	QS-G1/8-8-I	QS-G1/4-10-I
		12/14 on left	Blanking plug	B-M5	B-1/8	B-1/4
		1/11	Push-in fitting	QS-G1/8-8-I	QS-G1/4-10-I	QS-G3/8-12-I
With pneumatic multiple connector plate; code M						
	Y	82/84	Silencer	UC-M7	AMTE-M-LH-G18	AMTE-M-LH-G12
		12/14	Blanking plug	B-M7	B-1/8	B-1/4
		3/5	Silencer	AMTE-M-LH-G12	AMTE-M-LH-G38	AMTE-M-LH-G12
		1/11 on left	Push-in fitting	QS-G1/8-8-I	QS-G1/4-10-I	QS-G3/8-12-I
		11 on right	Blanking plug	B-1/8	B-1/4	B-3/8
	Z	82/84	Silencer	UC-M7	AMTE-M-LH-G18	AMTE-M-LH-G12
		3/5	Silencer	AMTE-M-LH-G12	AMTE-M-LH-G38	AMTE-M-LH-G12
		12/14	Push-in fitting	QSM-M7-6-I	QS-G1/8-8-I	QS-G1/4-10-I
		1/11 on left	Push-in fitting	QS-G1/8-8-I	QS-G1/4-10-I	QS-G3/8-12-I
With pneumatic multiple connector plate; code P, GQC						
	Y	82/84	Silencer	AMTE-M-LH-M5	AMTE-M-LH-G18	AMTE-M-LH-G12
		12/14	Blanking plug	B-M5	B-1/8	B-1/4
		3/5	Silencer	AMTE-M-LH-G12	U-3/8-B	AMTE-M-LH-G12
		1/11 on left	Push-in fitting	QS-G1/8-8-I	QS-G1/4-10-I	QS-G3/8-12-I
		11 on right	Blanking plug	B-1/8	B-1/4	B-3/8
	Z	82/84	Silencer	AMTE-M-LH-M5	AMTE-M-LH-G18	AMTE-M-LH-G12
		3/5	Silencer	AMTE-M-LH-G12	AMTE-M-LH-G38	AMTE-M-LH-G12
		12/14	Push-in fitting	QSM-M5-6-I	QS-G1/8-8-I	QS-G1/4-10-I
		1/11 on left	Push-in fitting	QS-G1/8-8-I	QS-G1/4-10-I	QS-G3/8-12-I

Key features – Pneumatic components

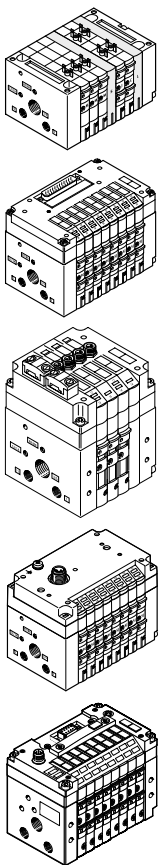
Pneumatic connection: fitting set for compressed air supply						
	Code Compressed air supply	Connection	Designation	Size 10 QS6 Type	Size 14 QS8 Type	Size 18 QS10 Type
	Without pneumatic multiple connector plate					
	A, B	82/84	Blanking plug	B-M5	B-1/8	B-1/4
		3/5	Blanking plug	B-3/8	B-1/2	B-1/2
		1	Push-in fitting	QS-G1/8-8-l	QS-G1/4-10-l	QS-G3/8-12-l
	C, D	82/84	Blanking plug	B-M5	B-1/8	B-1/4
		3/5	Blanking plug	B-3/8	B-1/2	B-1/2
		1	Push-in fitting	QS-G1/8-8-l	QS-G1/4-10-l	QS-G3/8-12-l
		12/14	Push-in fitting	QSM-M5-6-l	QS-G1/8-8-l	QS-G1/4-10-l
	With pneumatic multiple connector plate; code M					
	E, F, H	82/84	Blanking plug	B-M7	B-1/8	B-1/4
		3/5	Blanking plug	B-1/4	B-3/8	B-1/2
		1/11	Push-in fitting	QS-G1/8-8-l	QS-G1/4-10-l	QS-G3/8-12-l
		12/14	Push-in fitting	QSM-M7-6-l	QS-G1/8-8-l	QS-G1/4-10-l
	G, J, K	82/84	Blanking plug	B-M7	B-1/8	B-1/4
		3/5	Blanking plug	B-1/4	B-3/8	B-1/2
		On right in 1, left	Push-in fitting	QS-G1/8-8-l	QS-G1/4-10-l	QS-G3/8-12-l
		On right in 11	Blanking plug	B-1/8	B-1/4	B-3/8
		12/14	Blanking plug	B-M7	B-1/8	B-1/4
	With pneumatic multiple connector plate; code P, GQC					
	E, F, H	82/84	Blanking plug	B-M5	B-1/8	B-1/4
		3/5	Blanking plug	B-1/4	B-3/8	B-1/2
		1/11	Push-in fitting	QS-G1/8-8-l	QS-G1/4-10-l	QS-G3/8-12-l
		12/14	Push-in fitting	QSM-M5-6-l	QS-1/8-8-l	QS-1/4-10-l
	G, J, K	82/84	Blanking plug	B-M5	B-1/8	B-1/4
3/5		Blanking plug	B-1/4	B-3/8	B-1/2	
On right in 1, left		Push-in fitting	QS-G1/8-8-l	QS-G1/4-10-l	QS-G3/8-12-l	
On right in 11		Blanking plug	B-1/8	B-1/4	B-3/8	
12/14		Blanking plug	B-M5	B-1/8	B-1/4	

Key features – Pneumatic components

CPV valve terminal size 10 and 14 with valve extensions

Function blocks

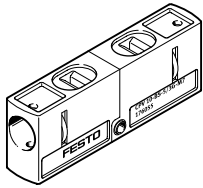

CPV10-BS-5/3G-M7
CPV14-BS-5/3G-1/8

Valve kit 5/3G for creating a 5/3-way function, mid-position closed, for size 10 and 14:
The valve function "mid-position closed" is created using a valve slice with 2x 3/2-way valve, normally closed (code C).
The valve kit CPV10-BS-5/3G-M7 or CPV14-BS-5/3G-1/8 (incorporating a double piloted check valve function) is used for this.

The valve kit is intended for use with one working pressure for each valve slice, i.e. it must not be used in dual-pressure operation (different pressure at port 1 and 11).

Additional functions for valve positions

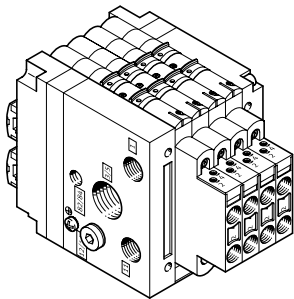

The valve terminal CPV in size 10 and 14 can be enhanced with further pneumatic functions with the aid of these valve extensions (vertical stacking):

- One-way flow control valves x2 for flow control directly at the valve terminal for
 - Supply air flow control
 - Exhaust air flow control
- The vacuum flow control module must be used with the vacuum generator with or without ejector pulse and offers a one-way function and an adjustable ejector pulse.



Note

The additional functions cannot be used on the first or last valve position in combination with a pneumatic multiple connector plate M, P, and cannot be used at all in combination with a pneumatic multiple connector plate GQC, GQE, GQD.

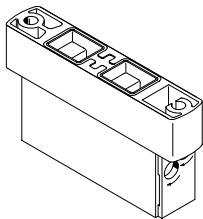

CPV10-BS-2xGRZZ-M7
CPV14-BS-2xGRZZ-1/8

- 2x one-way flow control valve for supply air flow control
- Additional function code P

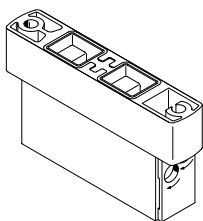

CPV10-BS-2xGRAZ-M7
CPV14-BS-2xGRAZ-1/8

- 2x one-way flow control valve for exhaust air flow control
- Additional function code Q

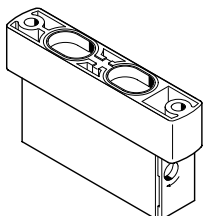

CPV10-BS-GRZ-V-M7
CPV14-BS-GRZ-V-1/8

- Vacuum flow control module
- Additional function code V

Key features – Mounting

Mounting options

The valve terminals have holes for four retaining screws, with the side for the pneumatic fittings being the screw-on surface. These drilled holes are also used to mount the valve terminal on the pneumatic multiple connector plate.

In addition to this type of mounting, there are other mounting options:

- H-rail mounting
- Wall mounting
- Wall mounting via pneumatic multiple connector plate with flange

- On rear side via wall mounting
- On the front (CPV10/14 with IC connection only)
- Mounting via through-hole in wall

The mountings are attached to the left and right end plates using a screw and a fixing bolt.

Mounting for H-rail

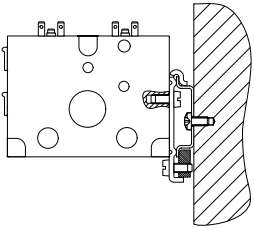

For valve terminal CPV10/14:
CPV10/14-VI-BG-NRH-35
(Mounting code H)

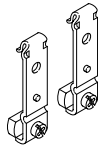

For valve terminal CPV18:
CPV18-VI-BG-NRH-35
(Mounting code H)



H-rail to EN 60715 not for accessories M, P, V (pneumatic multiple connector plate)

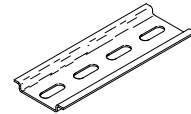

Attachment for wall mounting

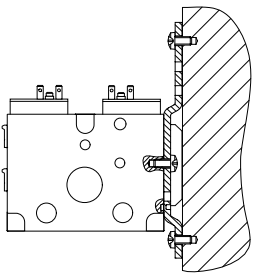

For valve terminal CPV10/14:
CPV10/14-VI-BG-RWL-B
(Mounting code U)

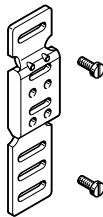

For valve terminal CPV18:
CPV18-VI-BG-RW
(mounting code W)

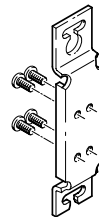

Attachment for individual connection and ET200X/ET200pro (included in the scope of delivery)

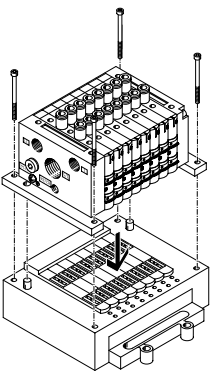

For valve terminal CPV10/14:
CPV...-VI-BG-ET200X
(mounting code X)

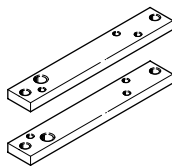

Through-hole in wall, e.g. on the machine

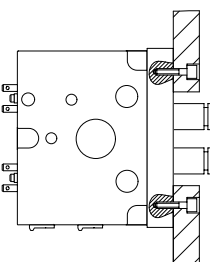

Wall mounting via pneumatic multiple connector plate

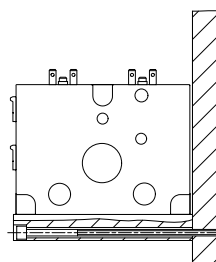

Key features – Mounting

Pneumatic multiple connector plate for wall/machine mounting

With flange, with all pneumatic connections, code P

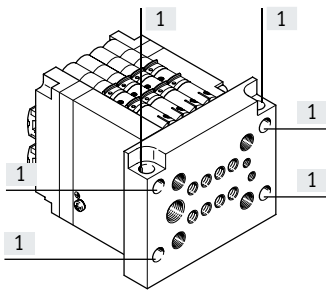

- For 10 mm, 14 mm and 18 mm
- Multiple connector plate protrudes at the end plates
- Through-holes for mounting (no thread) in the flange
- Two additional holes running cross-ways through this pneumatic multiple connector plate also allow rear mounting of valve terminal CPV.

[1] Mounting holes

Without flange, with all pneumatic connections, code M

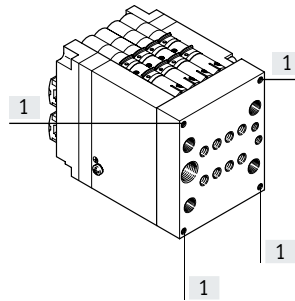

- For 10 mm, 14 mm and 18 mm
- Multiple connector plate ends flush with the end plates
- Mounting holes (with thread) for wall or base mounting in the connection side of the pneumatic multiple connector plate

[1] Mounting holes

Pneumatic multiple connector plate for control cabinet installation

With all pneumatic connections, code GQC

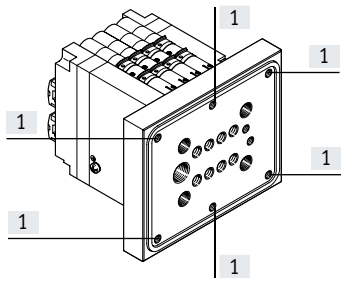

- For 10 mm and 14 mm
- Multiple connector plate protrudes at the end plates
- Mounting holes (with thread) in the flange
- Multiple connector plate with seal

[1] Mounting holes

With pneumatic ports 2 and 4, code GQD

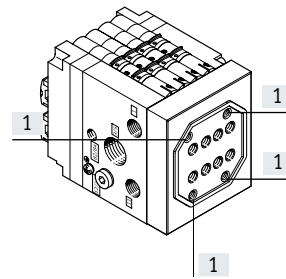

- For 10 mm and 14 mm
- Multiple connector plate ends flush with the end plates
- The mounting holes (with thread) are in the connection side of the pneumatic multiple connector plate
- Multiple connector plate with seal

[1] Mounting holes

With all pneumatic connections, code GQE

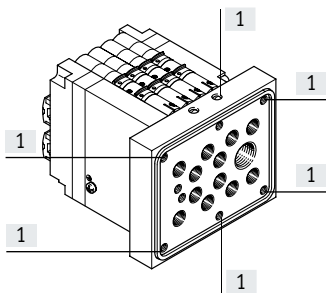

- For 10 mm
- Multiple connector plate protrudes at the end plates
- Mounting holes (with thread) in the flange
- Multiple connector plate with seal

[1] Mounting holes

Note

When using the pneumatic multiple connector plate M or P, the outermost valve slices cannot be fitted with valve extensions (e.g. one-way flow control valve).

Valve terminals CPV with flat plate silencer can only be mounted on a wall.

When using the pneumatic multiple connector plate GQC, GQD and GQE, the following restrictions apply:

- In general, no valve extensions can be fitted
- Cannot be combined with H-rail mounting
- Cannot be combined with wall mounting
- Only with 10 mm and 14 mm

Key features – Display and operation

Manual override

Three types of manual override are available:

- Non-detenting via slide
- Detenting
- Blocked

A subsequent conversion of the manual override (MO) from non-detenting to detenting or blocked is possible at any time.

To do this, the valve locking mechanism must first be removed. This is only possible when the individual valve is not installed or by removing the tie rod on the valve terminal.



Note

Follow the instructions in the user documentation when doing this.

Code	Illustration	Size			Note
		10	14	18	
N	<p>Manual override, non-detenting</p>	■	■	■	In the "non-detenting" version, a locking mechanism prevents the blue slider from moving. The manual override is activated using a pointed object (ballpoint pen or similar) through the opening.
R	<p>Manual override, detenting</p>	■	■	■	In the "detenting" version, the manual override is activated by sliding the slider. A locking mechanism can be used to provide the non-detenting function.
V	<p>Manual override, blocked</p>	■	■	■	In the "blocked" version, the detenting and non-detenting activation is prevented by a cover. As with the non-detenting locking mechanism, this cover can be added subsequently, but cannot then be removed from the valve.

Key features – Display and operation

Display and operation

LEDs for indicating the switching status are located on the electrical connection for the valve terminal CPV:

- Indicating the switching status of the pilot solenoid coil 12 for output 2
- Indicating the switching status of the pilot solenoid coil 14 for output 4

- Can be read from "above" as well as from the "front"

With individual connection, an LED for indicating the switching status is located in the connector plug.

Inscription labels

- Clip with inscription field on the connector plug (for individual connection)
- Labelling clips on the connection node (multi-pin, AS-Interface, installation system CP, Fieldbus Direct)

Valve manifold assembly CPV with individual connection

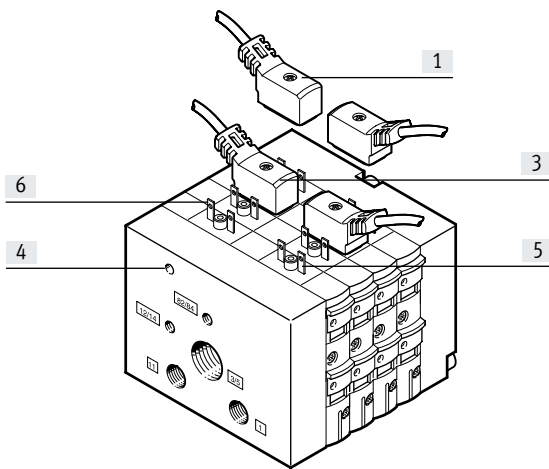

- [1] Pre-assembled connecting cable for each pilot solenoid coil
- [2] Slot for inscription label
- [3] Yellow LED, signal status indication of the pilot solenoid coils (for each connecting cable)
- [4] Earth connection

CPV valve terminal with multi-pin plug connection

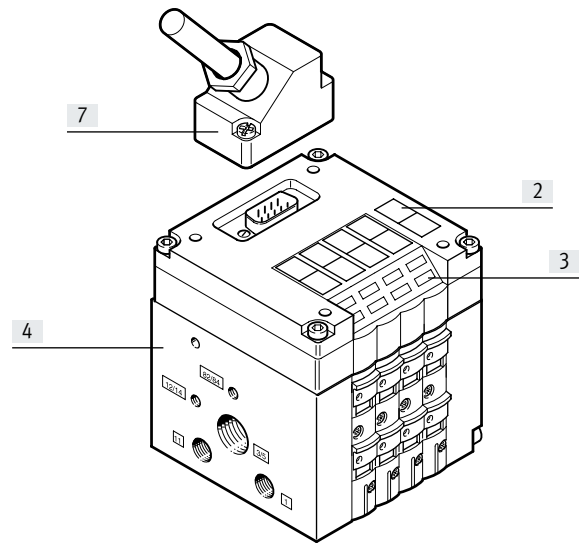

- [5] Terminal lug for solenoid coil 14
- [6] Terminal lug for solenoid coil 12
- [7] Sub-D multi-pin plug (9-pin for valve terminals with 4 valves, 25-pin for valve terminals with 6 or 8 valves)

Inscription system

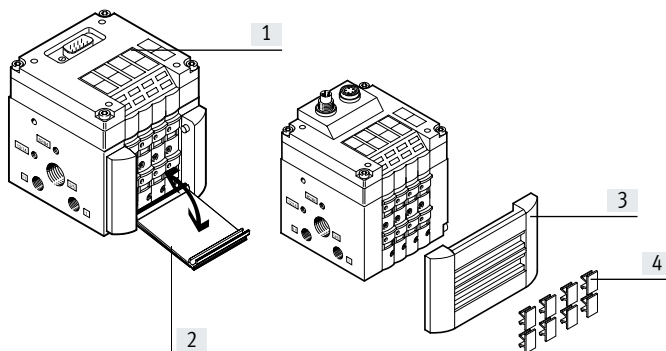

- [1] Inscription labels
Type IBS-6x10 for CPV10/14
Type IBS 9x20 for CPV18
- [2] Transparent inscription label holder for large paper labels (can be read from both sides)
- [3] Inscription label holder
- [4] Inscription labels type IBS 6x10

Inscription labels can be affixed as follows:

- On the top of the basic electrical unit
 - On the inscription label holder
- The inscription label holder enables additional inscription labels to be attached while covering the manual override, protecting it from unintentional activation. The inscription labels are used to record additional information regarding the valves.

They can be ordered together with the valve terminal using the code. The relevant inscription labels are supplied in a frame and are ordered separately.

Transparent inscription label holder

The transparent inscription label holder CPV...-VI-ST... offers an additional option for labelling, e.g. for large paper labels that can be read from both sides.

Key features – Electrical components

Electrical connection

The valve slice contacts that are directed upwards form the interface to different types of electrical connection. The electrical connection is secured from above using 4 screws.

With the same pneumatic part, the valve terminal can thus be adapted to the different electrical requirements or fieldbus protocols.

Electrical power

Valves CPV10/14 are controlled via a current reduction which reduces the power consumption and prevents the generation of heat.

This current reduction is already integrated into the respective basic electrical unit (multi-pin connection or fieldbus interface) or into the connecting cable.

When switching off, voltage peaks are limited to 38 V DC.

Individual connection

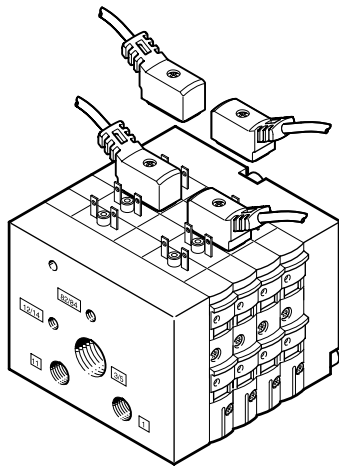

With individual connections, integration is on the pneumatic part only; the solenoid valves are connected with individual cables.

Key features – Electrical components

Dimensions – Connecting cable, individual connection

Download CAD data → www.festo.com

NEBV...

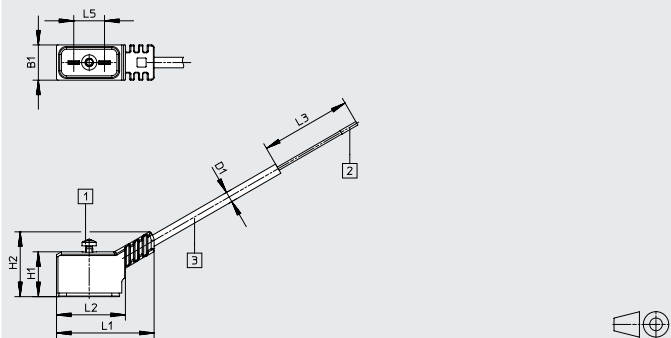

- [1] Retaining screw
- [2] Wire ferrule
- [3] Cable, length depending on the order

KMEB-2-24-...-LED

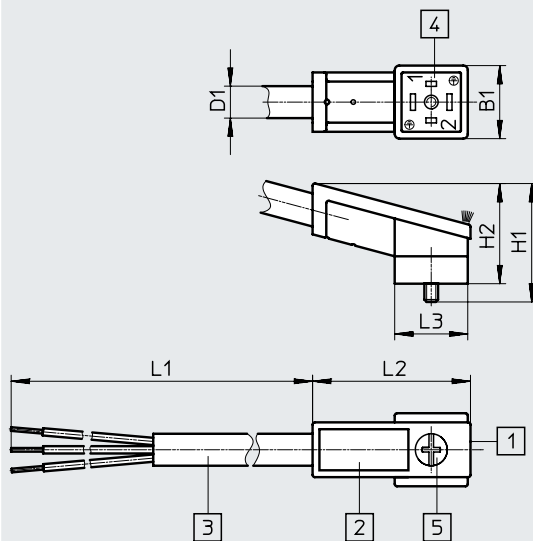

- [1] LED illuminated area
- [2] Inscription label IBS-9x20 Part no. 18182
- [3] 3-core cable 2.5 or 5 m (3x 0.75 mm²)
- [4] Plug pattern to EN 175301-803, type C
- [5] M2.5 screw, captive, screw-head: Pozidriv combi cross-slot to EN 7045

Type	B1	D1	H1	H2	L1	L2	L3	L5
NEBV-Z3WA2L...	9.7	2.9	12.4	17.5	26.9	19	50	8.4
KMEB-2-24-2.5-LED	16	7	26	22	2500	34.6	16	-
KMEB-2-24-5-LED					5000			

Key features – Electrical components

ET200X/ET200pro pneumatic interface for CPV10 and CPV14

Adaptation of the valve manifold assembly CPV to the input/output module ET200X/ET200pro from Siemens.
Combining the function modules of ET200X/ET200pro with the pneumatic functions of the valve manifold assembly CPV creates a highly integrative automation solution for systems for electric and pneumatic drives with:

- 8 valve slices for up to 16 CPV valves

- Faster and more reliable contacting
- Valve manifold assembly CPV10 and CPV14
- High degree of protection IP65/IP67
- Modular design
- Large number of I/O modules
 - Digital I/O
 - Analogue I/O
 - Branching used to control three-phase motors
- PROFIBUS DP interface

Mounting set for ET200X CPV-...-VI-BG-ET200X (included in the scope of delivery)

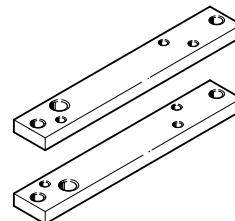

Specific data for the ET200X/ET200pro pneumatic interface can be found in the Siemens product catalogues.

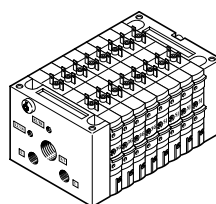
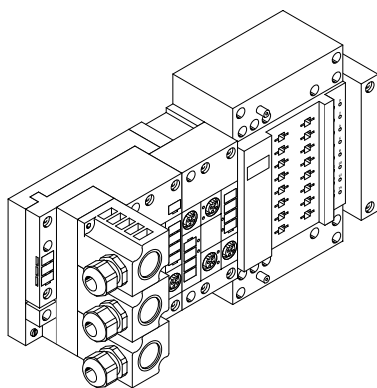

Note

With valve manifold assembly CPV10-ET200pro, a moulded seal is required to achieve the IP degree of protection. The moulded seal CPV10-GE-8 or CPV14-GE-8 must be ordered separately.

Note

Not permitted in combination with CPV10-EX-VI.

Multi-pin plug connection

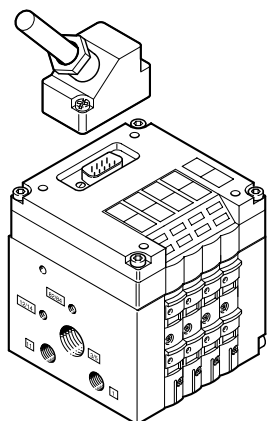

The multi-pin plug connection provides electrical integration in addition to pneumatic integration, and enables the control cabinet and the valve terminal to be connected using a single cable.

IP65 protection is guaranteed even with the Sub-D push-in connectors thanks to the plug housing of the cable KMP...

The following plug sizes are used:

- Valve terminal with 4 valves: 9-pin
- Valve terminal with 6 valves: 25-pin
- Valve terminal with 8 valves: 25-pin

Pre-assembled connecting cables are supplied for ease of connection.

Lengths of 5 m and 10 m can be supplied as standard. The pre-assembled connecting cables are also available in a version suitable for energy chains. The cable KMP6-... can be used instead for applications with IP40 protection.

Key features – Electrical components

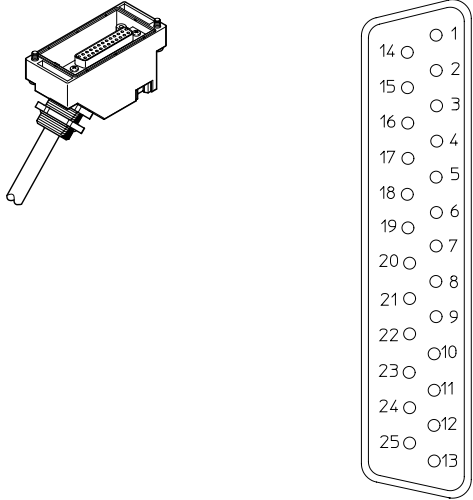
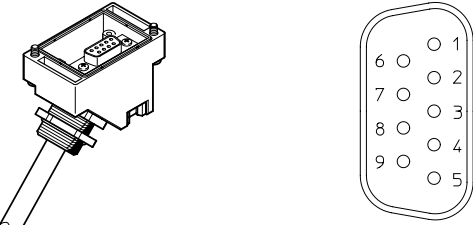
Pin allocation – Pre-assembled multi-pin cable (view from plug-in direction)		Pin	Wire colour	Valve 24 V DC	
Cable KMP3-25P-16... or KMP4-25P... with 25-pin Sub-D plug for valve terminals with 6 or 8 valves					
	14	1	White	1	14
	15	2	Green		12
	16	3	Yellow	2	14
	17	4	Grey		12
	18	5	Pink	3	14
	19	6	Blue		12
	20	7	Red	4	14
	21	8	Violet		12
	22	9	Grey-pink	5	14
	23	10	Red-blue		12
	24	11	White-green	6	14
	25	12	Brown-green		12
		13	White-yellow	7	14
		14	Yellow-brown		12
		15	White-grey	8	14
		16	Grey-brown		12
		17	White-pink (KMP4 only)		
		18	Pink-brown (KMP4 only)		
		19	White-blue (KMP4 only)		
		20	Brown-blue (KMP4 only)		
		21	White-red (KMP4 only)		
		22	Brown-red (KMP4 only)		
		23	White-black (KMP4 only)		
		24	Brown	(0 V) ¹⁾	
		25	Black	(0 V) ¹⁾	
Cable KMP3-9P... or KMP4-9P... with 9-pin Sub-D plug for valve terminals with 4 valves					
	6	1	White	1	14
	7	2	Green		12
	8	3	Yellow	2	14
	9	4	Grey		12
		5	Pink	3	14
		6	Blue		12
		7	Red	4	14
		8	Violet		12
		9	Black	Common	

1) 0 V for positive switching control signals; connect 24 V for negative switching control signals; mixed operation is not permitted.

Key features – Electrical components

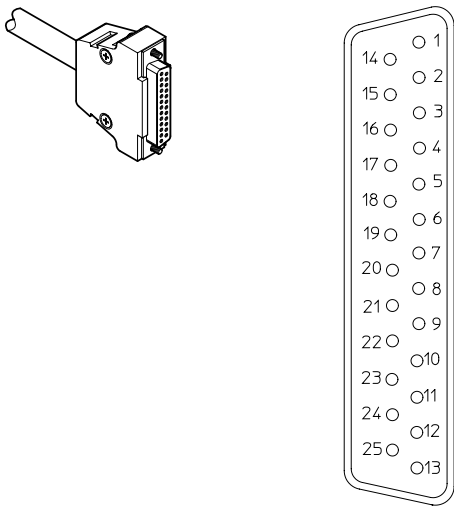
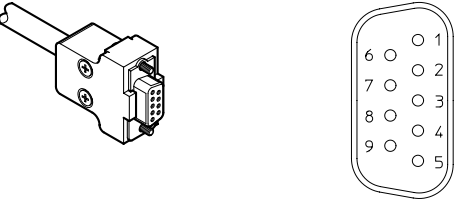
Pin allocation – Pre-assembled multi-pin cable (view from plug-in direction)		Pin	Wire colour	Valve 24 V DC	
Cable KMP6-25P-20... with 25-pin Sub-D plug for valve terminals with 6 or 8 valves					
	1	White	1	14	
	2	Brown		12	
	3	Green	2	14	
	4	Yellow		12	
	5	Grey	3	14	
	6	Pink		12	
	7	Blue	4	14	
	8	Red		12	
	9	Black	5	14	
	10	Violet		12	
	11	Grey-pink	6	14	
	12	Red-blue		12	
	13	White-green	7	14	
	14	Brown-green		12	
	15	White-yellow	8	14	
	16	Yellow-brown		12	
	17	White-grey			
	18	Grey-brown			
	19	White-pink			
	20	Pink-brown			
	21	White-blue ¹⁾			
	22	Brown-blue ¹⁾			
	23	White-red ¹⁾			
	24	Brown-red ¹⁾		(0 V) ²⁾	
	25	White-black ¹⁾		(0 V) ²⁾	
Cable KMP6-9P-20... with 9-pin Sub-D plug for valve terminals with 4 valves					
	1	White	1	14	
	2	Brown		12	
	3	Green	2	14	
	4	Yellow		12	
	5	Grey	3	14	
	6	Pink		12	
	7	Blue	4	14	
	8	Red		12	
	9	Black	Common		

1) Wire cross section 0.34 mm²

2) 0 V for positive switching control signals; connect 24 V for negative switching control signals; mixed operation is not permitted.

 **Note**

Two threaded sleeves (NEAU-TA-M35-U4, → p. 69) are required to secure the multi-pin cable KMP6.

Key features – Electrical components

Valve terminal CPV – AS-Interface valve terminal

The AS-Interface allows individual components or small component groups to be widely distributed in terms of space.

The AS-Interface connection of valve terminal CPV can be used to control 2, 4 or 8 solenoid coils.

The valve terminal cover contains LEDs that indicate the operating status and the protective circuit for the valves.

The standard AS-Interface protocol permits a maximum of 4 inputs and 4 outputs in one unit. By using 2 AS-Interface slaves in one valve terminal, it is possible to control 8 inputs and 8 out-

puts in a valve terminal with 8 valves (8 solenoid coils).

All valve terminals CPV can be operated with other functions such as vacuum generators.

Valve terminals CPV with inputs are also available for A/B mode to SPEC 2.1 and 3.0.

AS-Interface control

- For 2, 4 or 8 valves
- Wide range of variants from the broad modular offering

AS-Interface with A/B operation

- For 3 or 4 or for 6 or 8 valves, depending on the specification
- It still provides all the benefits of the straightforward installation system
- 100% more inputs/master
- 50% more outputs/master
- Improved diagnostics of faults in the peripherals
- More functions on the AS-Interface within Spec 2.1 and 3.0.

→ Internet: as-interface

AS-Interface valve terminal with auxiliary power supply

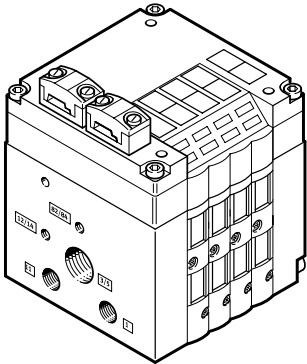

AS-Interface valve terminal with auxiliary power supply and inputs

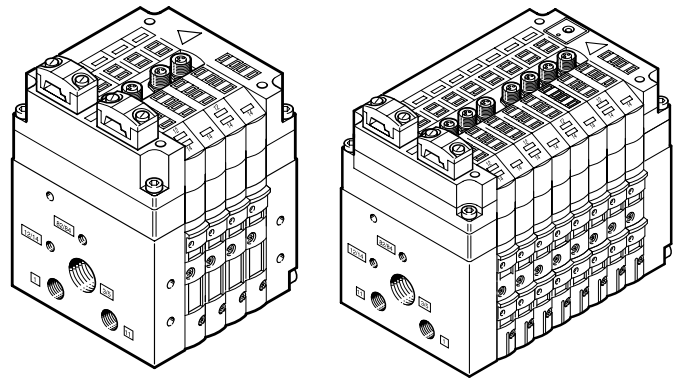

Key features – Electrical components

I-Port interface/IO-Link®

The I-Port interface/IO-Link® enables the valve terminal CPV to be connected to the following systems:

- I-Port master from Festo (CPX terminal, CECC)
- Bus node CTEU from Festo
- IO-Link® master

A maximum of 16 solenoid coils can be actuated, distributed over a maximum of 8 valve positions.

The maximum distance between the I-Port/IO-Link® master and valve terminal with I-Port interface/IO-Link is 20 m.

The 5-pin connecting cables contain the power supply for the valves; the power supply for the internal valve terminal electronics and the control signals are separate from this.

The valve terminal cover contains LEDs that indicate the operating status and the protective circuit for the valves.

All valve terminals CPV can be operated with other functions such as vacuum generators.

- Internet: cteu
- Internet: cpx

CPV valve terminal with I-Port interface/IO-Link®

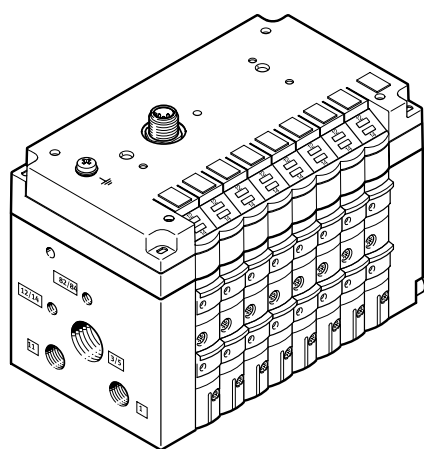

CPV valve terminal with I-Port interface with bus node

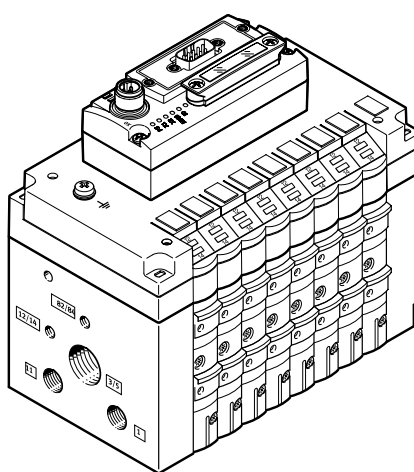

Installation system CP/CPI, valve terminal

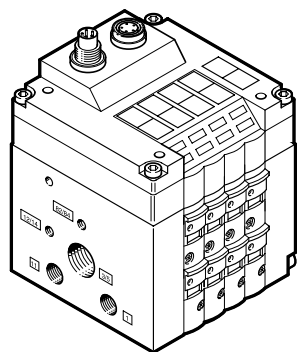

The valve terminals CPV are integrated into fieldbus systems or stand-alone control systems by connecting the terminals using single, pre-assembled terminal connections to the corresponding bus node or control block.

The system integrates the valve terminal CPV and various I/O modules, etc. into a single installation concept.

The 5-pin connecting cables carry the supply power and control signals. The valve terminal cover contains LEDs that indicate the operating status and the protective circuits for the valves.

The input and output statuses of the connected module are exchanged with the CP bus node via the CP string.

- Internet: cpi

- Max. 8 valve slices for up to 16 CPV valves

Instructions for use

Fieldbus Direct valve terminal

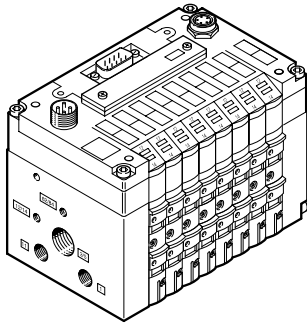

Fieldbus Direct is a system for connecting a valve terminal, like Profibus for example.

The CP string extension option enables the functions and components of the CPI installation system to be used.

The optional string extension allows additional valve terminals and I/O modules with CP/CPI function to be

connected to the Fieldbus Direct bus node.

Depending on the version, the valve terminals are available in all three sizes, 10, 14 and 18 mm, each having 8 valve slices.

Operating materials

Operate your system with unlubricated compressed air, if possible. Festo valves and cylinders are designed so that, if used as intended, they will not require additional lubrication and will still achieve a long service life. The quality of compressed air downstream of the compressor must correspond to that of unlubricated compressed air. If possible, do not operate the entire system with lubricated compressed air. The lubricators should, where possible, always be installed directly upstream of the actuator requiring them.

Incorrect additional oil and too high an oil content in the compressed air reduce the service life of the valve terminal.

Use Festo special oil OFSW-32 or the alternatives listed in the Festo catalogue (as specified in DIN 51524 HLP32; basic oil viscosity 32 CST at 40°C).

Bio-oils

When using bio-oils (oils which are based on synthetic or native esters, e.g. rapeseed oil methyl ester), the maximum residual oil content of 0.1 mg/m³ must not be exceeded (see ISO 8573-1 Class 2).

Mineral oils

When using mineral oils (e.g. HLP oils to DIN 51524, parts 1 to 3) or similar oils based on poly-alpha-olefins (PAO), the maximum residual oil content of 5 mg/m³ must not be exceeded (see ISO 8573-1 Class 4).

A higher residual oil content is not permitted, regardless of the compressor oil, because the permanent lubrication would otherwise be flushed out over a period of time.

Datasheet

-  Flow rate up to
 CPV10: 400 l/min
 CPV14: 800 l/min
 CPV18: 1600 l/min

-  Valve width
 CPV10: 10 mm
 CPV14: 14 mm
 CPV18: 18 mm

-  Voltage
 24 V DC



General technical data		CPV10	CPV14	CPV18
Design		Electromagnetically actuated piston spool valve		
Lubrication		Life-time lubrication, PWIS-free (free of paint-wetting impairment substances)		
Type of mounting		Via pneumatic multiple connector plate		
		Via backwall		
		On H-rail		
Mounting position		Any		
Overlap		Positive overlap		
Manual override		Non-detenting/detenting/blocked		
Width	[mm]	10	14	18
Nominal size	[mm]	4	6	8
Nominal flow rate without fitting	[l/min]	400	800	1600 1400 ³⁾
b value		0.4	0.42 0.37 ²⁾	0.38 0.41 ²⁾ 0.40 ³⁾
c value	[l/sbar]	1.6	3.2	6.3 5.66 ³⁾
Pneumatic connections¹⁾				
Pneumatic connection		Via end plate or pneumatic multiple connector plate		
Supply port	1/11	G1/8	G1/4	G3/8
Exhaust port	3/5	G3/8 (G1/4)	G1/2 (G3/8)	G1/2
Working ports	2/4	M7	G1/8	G1/4
Pilot air port	12/14	M5 (M7)	G1/8	G1/4
Pilot exhaust air port	82/84	M5 (M7)	G1/8	G1/4

1) Connection dimensions in brackets for pneumatic multiple connector plate

2) Values for 2x 2/2-way valve

3) Values for 5/3-way valve with mechanical spring return

Safety characteristics		CPV10	CPV14	CPV18
Tried-and-tested component		Yes		
Max. positive test pulse with logic 0	[μs]	1400	1400	1900
Max. negative test pulse with logic 1	[μs]	700	400	1700
Shock resistance		Shock test with severity level 2, to EN 60068-2-27		
Vibration resistant		Transport application test with severity level 2, to EN 60068-2-6		

Datasheet

Operating and environmental conditions – Valves of width 10 mm												
Valve function order code	M, MK	F	J, JK	N, NK	C, CK	H, HK	D, DK	I, IK	CY	G ²⁾	A	E
Operating medium	Compressed air to ISO 8573-1:2010 [7:4:4] → 36											
Note on the operating/pilot medium	Lubricated operation possible (in which case lubrication will always be required)											
Operating pressure	[MPa]	-0.09 ... +1							+0.01 ... +1	-	-	-
	[bar]	-0.9 ... +10							+0.1 ... +10	2.5 ... +10	3 ... +8	2 ... +10
Operating pressure for valve terminal with internal pilot air supply	[MPa]	0.3 ... 0.8							-	-	-	
	[bar]	3 ... 8							-	-	-	
Pilot pressure	[MPa]	0.3 ... 0.8							-	-	-	
	[bar]	3 ... 8							-	-	-	
Ambient temperature	[°C]	-5 ... +50									0 ... +50	
Temperature of medium	[°C]	-5 ... +50									0 ... +50	
Storage temperature	[°C]	-20 ... +40										
Duty cycle	[%]	100 (in conjunction with holding current reduction)										
Relative air humidity at 25°C	[%]	95 with no condensation										
Corrosion resistance class CRC ¹⁾	2										1	
Note on materials	RoHS-compliant											

1) More information www.festo.com/x/topic/crc

2) 5/3G function possible as kit for width 10 mm and 14 mm

Operating and environmental conditions – Valves of width 14 mm												
Valve function order code	M, MK	J, JK	N, NK	C, CK	H, HK	D, DK	I, IK	G ²⁾	A	E		
Operating medium	Compressed air to ISO 8573-1:2010 [7:4:4] → 36											
Note on the operating/pilot medium	Lubricated operation possible (in which case lubrication will always be required)											
Operating pressure	[MPa]	-0.09 ... +1							-	-	-	
	[bar]	-0.9 ... +10							2.5 ... +10	3 ... +8	2 ... +10	
Operating pressure for valve terminal with internal pilot air supply	[MPa]	0.3 ... 0.8							-	-	-	
	[bar]	3 ... 8							-	-	-	
Pilot pressure	[MPa]	0.3 ... 0.8							-	-	-	
	[bar]	3 ... 8							-	-	-	
Ambient temperature	[°C]	-5 ... +50									0 ... +50	
Temperature of medium	[°C]	-5 ... +50									0 ... +50	
Storage temperature	[°C]	-20 ... +40										
Duty cycle	[%]	100 (in conjunction with holding current reduction)										
Relative air humidity at 25°C	[%]	95 with no condensation										
Corrosion resistance class CRC ¹⁾	2										1	
Note on materials	RoHS-compliant											

1) More information www.festo.com/x/topic/crc

2) 5/3G function possible as kit for width 10 mm and 14 mm

Datasheet

Operating and environmental conditions – Valves of width 18 mm											
Valve function order code	M	J	N	C	H	D	I	G	A	E	
Operating medium	Compressed air to ISO 8573-1:2010 [7:4:4] → 36										
Note on the operating/pilot medium	Lubricated operation possible (in which case lubrication will always be required)										
Operating pressure	[MPa]	-0.09 ... +1							-	-	
	[bar]	-0.9 ... +10							3 ... +8	2 ... +10	
Operating pressure for valve terminal with internal pilot air supply	[MPa]	0.3 ... 0.8							-	-	
	[bar]	3 ... 8							-	-	
Pilot pressure	[MPa]	0.3 ... 0.8	0.2 ... 0.8	0.3 ... 0.8			0.35 ... 0.8	-	-		
	[bar]	3 ... 8	2 ... 8	3 ... 8			3.5 ... 8	-	-		
Ambient temperature	[°C]	-5 ... +50								0 ... +50	
Temperature of medium	[°C]	-5 ... +50								0 ... +50	
Storage temperature	[°C]	-20 ... +40									
Duty cycle	[%]	100									
Relative air humidity at 25°C	[%]	95 with no condensation									
Corrosion resistance class CRC ¹⁾	2								1		
Note on materials	RoHS-compliant										

1) More information www.festo.com/x/topic/crc

Datasheet

ATEX	
ATEX category for gas	II 3G
Type of (ignition) protection for gas	Ex nA IIC T4 X Gc
Valve terminal certifications	
UL certified	c UL us Recognized (OL)
Explosion protection certification outside the EU	EPL Gc (GB)
	NEC 500 Class I, Div. 2
CE marking (see declaration of conformity) ¹⁾	To EU RoHS Directive
	To EU Explosion Protection Directive (ATEX)
	To EU EMC Directive
UKCA marking (see declaration of conformity) ¹⁾	To UK RoHS instructions
	To UK EX instructions
	To UK instructions for EMC
KC marking	KC EMC
Certification	RCM
	C-Tick

1) More information: www.festo.com/catalogue/... → Support/Downloads.

 **Note**

The approvals and certificates apply only to fully assembled valve terminals that have been fully configured using the configurator and have the associated identification on the product.

Please observe the associated user documentation (e.g. ATEX operating conditions or UL operating conditions).

Valve terminals CPV with explosion protection certification according to NEC 500 Class I, Div. 2 are approved for types MP and IC.

 **Note**

Please use push-in fittings and silencers with electrically conductive straight thread.

ATEX				
Certifications for pneumatic multiple connector plates for the valve terminal CPV				
Pneumatic multiple connector plate	CPV10-VI-P...-C	CPV10-VI-P...-D	CPV14-VI-P...-C.	CPV14-VI-P...-D
ATEX category for gas	II 2G			
Type of (ignition) protection for gas	Ex ec IIC Gb			
ATEX category for dust	II 2D			
Type of (ignition) protection for dust	Ex tc IIIC Db			
ATEX ambient temperature [°C]	-10°C ≤ Ta ≤ +60°C			
Certificate-issuing authority	IECEX TUR 12.0002X			
	TÜV 06 ATEX 7334 X			
	German Technical Control Board (TÜV) 21 UKEX 7013 X			
Explosion protection certification outside the EU	EPL Dc (IECEX)			
	EPL Db (IECEX)			
	EPL Db (GB)			
	EPL Gc (IECEX)			
	EPL Gb (IECEX)			
	EPL Gb (GB)			
CE marking (see declaration of conformity) ¹⁾	To EU Explosion Protection Directive (ATEX)			
UKCA marking (see declaration of conformity) ¹⁾	To UK explosion regulations			
	To UK RoHS regulations			

1) More information: www.festo.com/catalogue/... → Support/Downloads.

Datasheet

Electrical data		CPV10	CPV14	CPV18
Operating voltage	[V DC]	24 (+10/-15%)		
Ramp steepness (IC and MP only)	[V/ms]	> 0.4 minimum voltage rise time to reach the high-current phase		
Limitation of the voltage peaks when switching off	[V DC]	38		
Residual ripple	[Vss]	4		
Electrical power consumption	[W]	0.6 (0.45 at 21 V); (with CPV10-M11H-... 0.65)	0.9 (0.65 at 21 V)	1.5 (0.95 at 21 V)
Protection against electric shock (protection against direct and indirect contact to EN 60204-1/IEC 204)		Through PELV power supply unit		
Protection rating to EN 60529	[IP]	65 (for all types of signal transmission in mounted state)		

Valve switching times [ms]																				
Valve function order code		M	MK	F	J	JK	N	NK	C	CK	CY	H	HK	G	D	DK	I	IK	A	E
CPV10																				
Switching times	On	17	17	12	-	-	17	17	17	17	17	17	17	20	15	15	15	15	-	15
	Off	27	27	17	-	-	25	25	25	25	25	25	25	30	17	17	17	17	-	17
	Change-over	-	-	-	10	10	-	-	-	-	-	-	-	-	-	-	-	-	-	-
CPV14																				
Switching times	On	25	25	-	-	-	24	24	24	24	-	24	24	22	13	13	13	13	-	13
	Off	35	35	-	-	-	30	30	30	30	-	30	30	30	16	16	16	16	-	16
	Change-over	-	-	-	12	12	-	-	-	-	-	-	-	-	-	-	-	-	-	-
CPV18																				
Switching times	On	18	-	-	-	-	18	-	18	-	-	-	-	14	14	-	14	-	-	14
	Off	26	-	-	-	-	24	-	24	-	-	-	-	32	20	-	20	-	-	20
	Change-over	-	-	-	12	-	-	-	-	-	-	-	-	-	-	-	-	-	-	-

Materials		CPV10	CPV14	CPV18
Basic electrical unit		Die-cast aluminium, PA, NBR		
Valve slices		Die-cast aluminium		
Valve module 5/3G		Die-cast aluminium, POM		
Blanking plate/separator plate		PA		
End plates		Die-cast aluminium		
Flat plate silencer		Die-cast aluminium, PE		
Pneumatic multiple connector plate		Wrought aluminium alloy		
Inscription label holder		POM, PVC		
Seal		NBR, HNBR		

Datasheet

Product weight				
Approx. weights	[g]	CPV10	CPV14	CPV18
Electrical connection plate with AS-Interface connection				
• on CP valve terminals with 2 valve positions	85	130	275	
• on CP valve terminals with 4 valve positions	110	175	355	
• on CP valve terminals with 8 valve positions	400	460	–	
Electrical connection plates with CP connection				
• on CP valve terminals with 4 valve positions	145	230	–	
• on CP valve terminals with 6 valve positions	180	250	–	
• on CP valve terminals with 8 valve positions	200	300	–	
Electrical connection plates with MP connection				
• on CP valve terminals with 4 valve positions	110	170	400	
• on CP valve terminals with 6 valve positions	140	230	425	
• on CP valve terminals with 8 valve positions	165	275	515	
End plates (2 pieces)	160	280	740	
Pneumatic multiple connector plate				
• on CP valve terminals with 2 valve positions	120	270	520	
• on CP valve terminals with 4 valve positions	165	390	750	
• on CP valve terminals with 6 valve positions	225	510	870	
• on CP valve terminals with 8 valve positions	270	630	1300	
Flat plate silencer	147	234	–	
Blanking plate	25	45	90	
Separator plate	25	45	90	
Valve sub-bases, vacuum generators	70	110	260	
Function element: 5/3G function	46	105	–	
Function element: one-way flow control valve	25	54	125	

Datasheet

Vacuum generators

Vacuum as a function of operating pressure

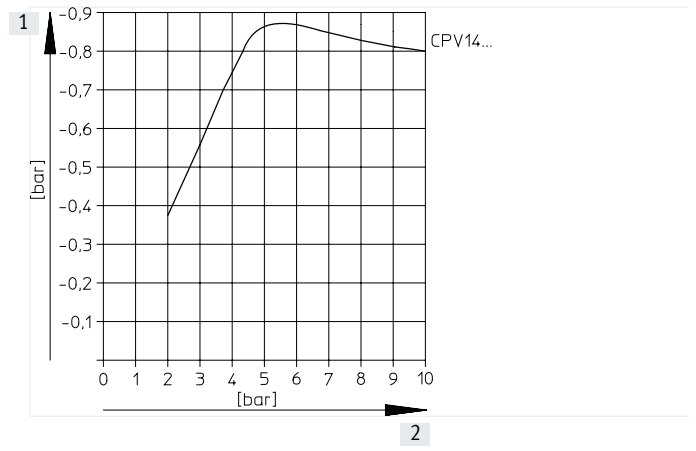
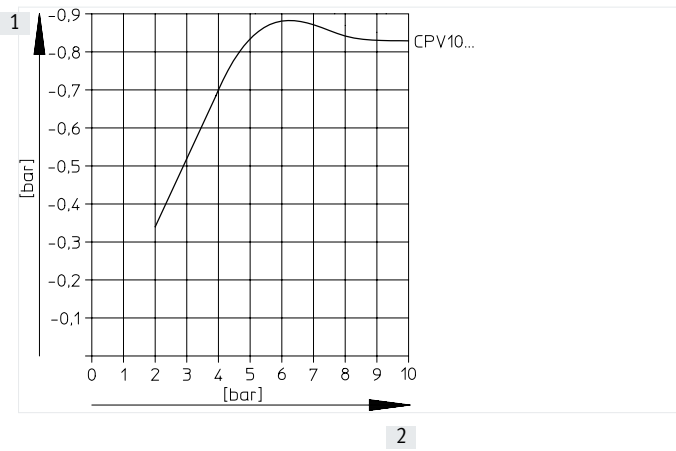

- [1] Vacuum [bar]
- [2] Operating pressure [bar]

- [1] Vacuum [bar]
- [2] Operating pressure [bar]

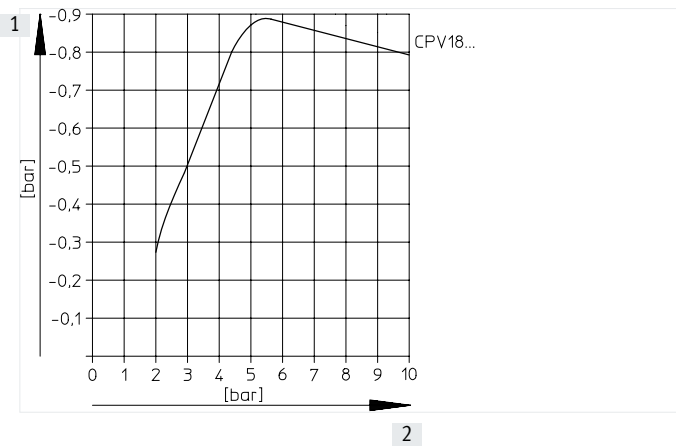

- [1] Vacuum [bar]
- [2] Operating pressure [bar]

Datasheet

Vacuum generators

Air consumption as a function of operating pressure

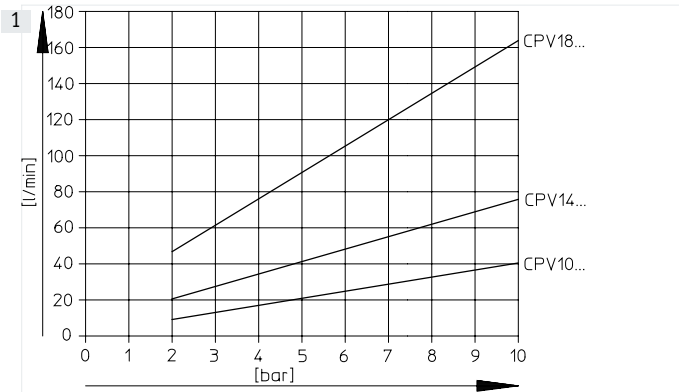

2

Evacuation time for a volume of 1 litre at P_{nom}

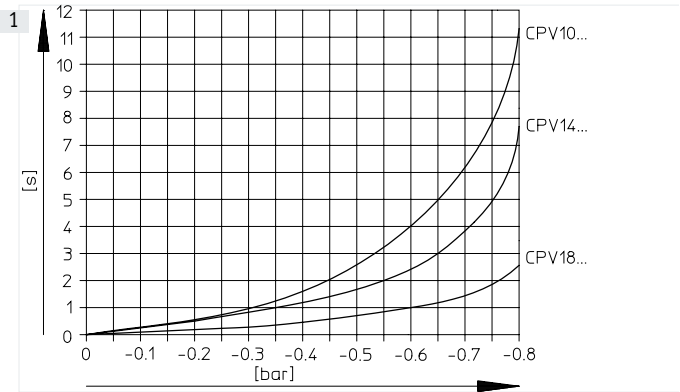

2

- [1] Air consumption [l/min]
- [2] Operating pressure [bar]

- [1] Evacuation time [s]
- [2] Vacuum [bar]

Suction capacity as a function of negative pressure at P_{nom}

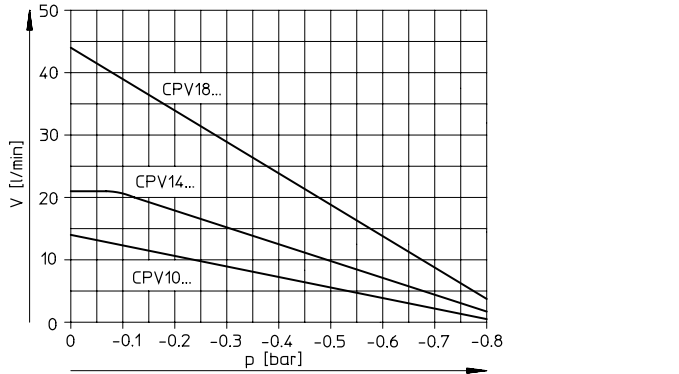

Datasheet

Dimensions

Download CAD data → www.festo.com

Valve manifold assembly with individual connection – CPV10/14/18

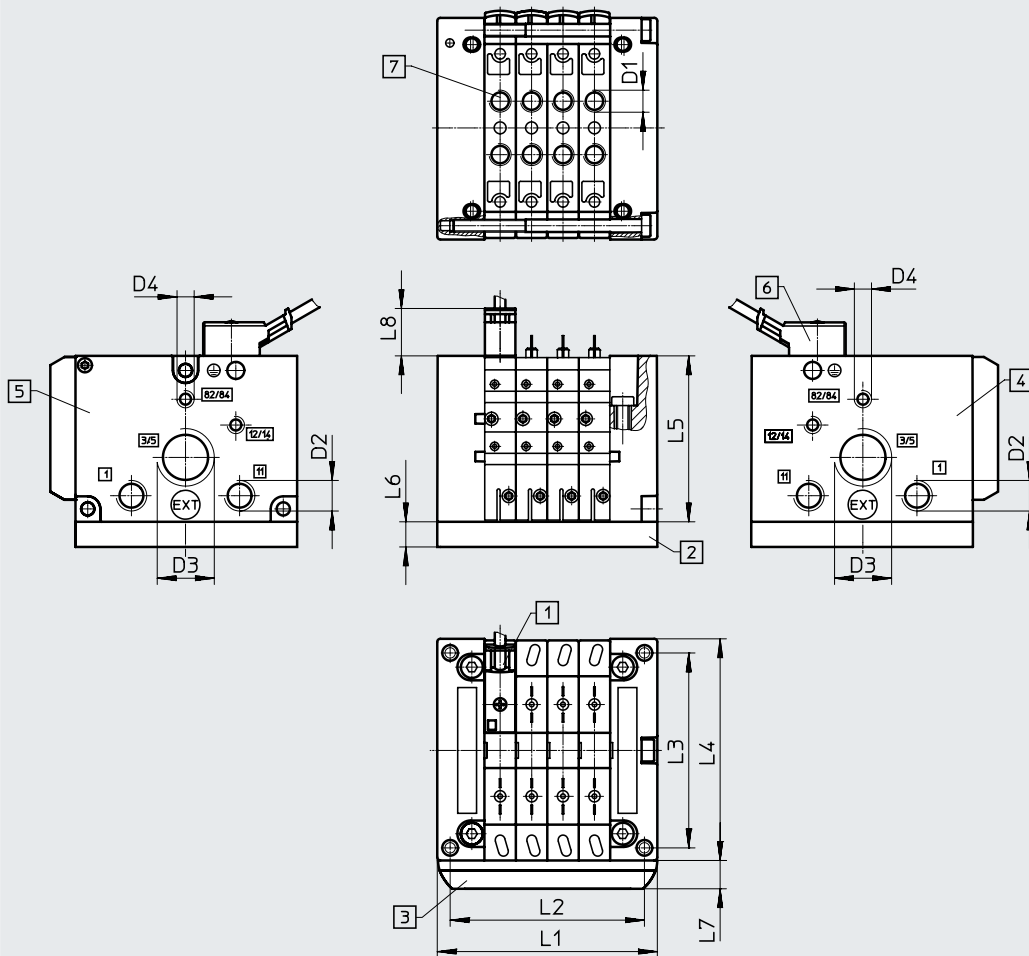

- [1] Slots for inscription labels
- [2] Pneumatic multiple connector plate
- [3] Holder for inscription labels (CPV10/14/18-VI-BZ-T... or CPV10/14/18-VI-ST-T...)
- [4] Left end plate (threaded connections not in combination with pneumatic multiple connector plate)
- [5] Right end plate (threaded connections not in combination with pneumatic multiple connector plate)
- [6] Connecting cable NEBV-... for CPV10/14 KMEB-2-... for CPV18
- [7] Individual threaded connection (without pneumatic multiple connector plate)

		L1	L2	L3	L4	L5	L6	L7	L8	D1	D2	D3	D4
CPV10	2 valves	50	41.8	62	71	52.8	15	9.5	11.8	M7	G1/8	G3/8	M5
	3 valves	60	51.8										
	4 valves	70	61.8										
	5 valves	80	71.8										
	6 valves	90	81.8										
	7 valves	100	91.8										
	8 valves	110	101.8										
	CPV14	2 valves	68										
3 valves		82	72										
4 valves		96	86										
5 valves		110	100										
6 valves		124	114										
7 valves		138	128										
8 valves		152	142										
CPV18		2 valves	96	85.5	106.5	118	73	20	9.5	21.6	G1/4	G3/8	G1/2
	3 valves	114	103.5										
	4 valves	132	121.5										
	5 valves	150	139.5										
	6 valves	168	157.5										
	7 valves	186	175.5										
	8 valves	204	193.5										

Datasheet

Dimensions

Download CAD data → www.festo.com

Valve manifold assembly with individual connection and flat plate silencer – CPV10/14/18

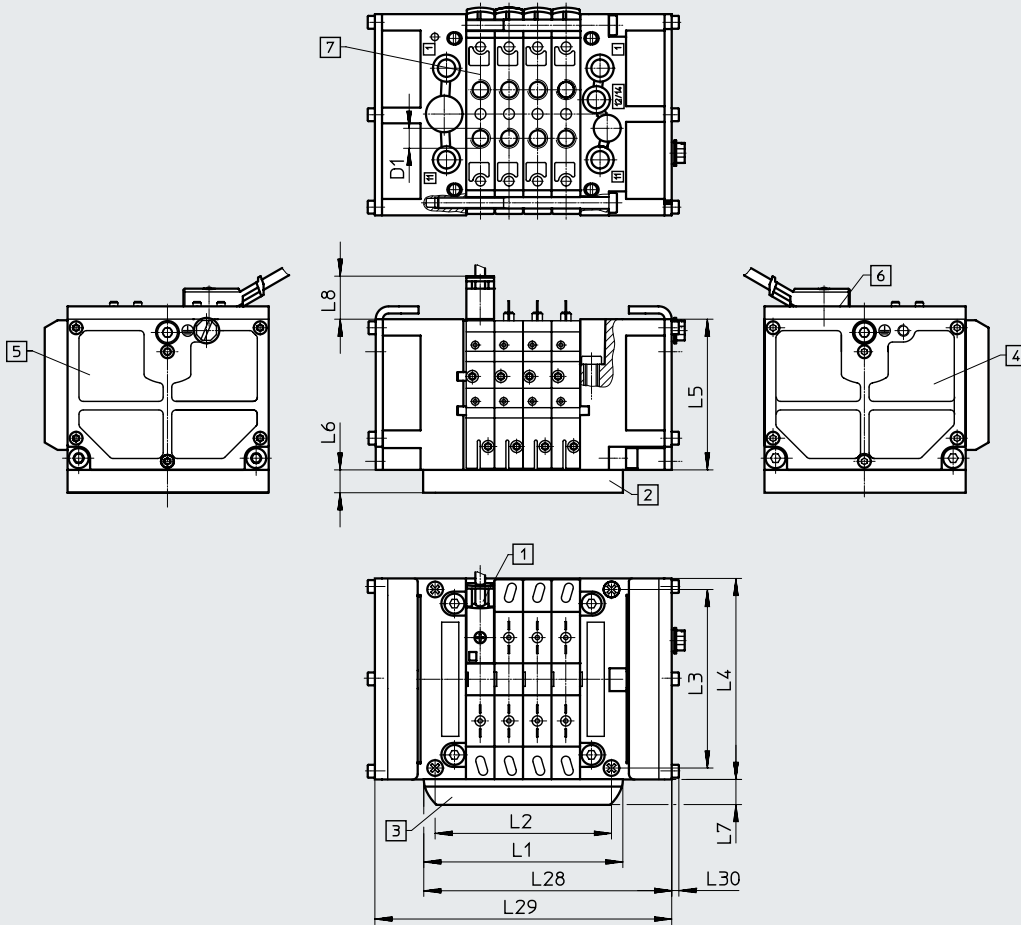

- [1] Slots for inscription labels
- [2] Pneumatic multiple connector plate
- [3] Holder for inscription labels (CPV10/14/18-VI-BZ-T... or CPV10/14/18-VI-ST-T...)
- [4] Left flat plate silencer
- [5] Right flat plate silencer
- [6] Connecting cable
NEBV... for CPV10/14
KMBE-2... for CPV18
- [7] Individual threaded connection (without pneumatic multiple connector plate)

		L1	L2	L3	L4	L5	L6	L7	L8	L28	L29	L30	D1
CPV10	2 valves	50	41.8	62	71	52.8	15	9.5	11.8	67	84	2.5	M7
	3 valves	60	51.8							77	94		
	4 valves	70	61.8							87	104		
	5 valves	80	71.8							97	114		
	6 valves	90	81.8							107	124		
	7 valves	100	91.8							117	134		
	8 valves	110	101.8							127	144		
	CPV14	2 valves	68							58	78		
3 valves		82	72	99	116								
4 valves		96	86	113	130								
5 valves		110	100	127	144								
6 valves		124	114	141	158								
7 valves		138	128	155	172								
8 valves		152	142	169	186								
CPV18		2 valves	96	85.5	106.5	118	73	20	9.5	21.6		127	158
	3 valves	114	105.5	145							176		
	4 valves	132	121.5	163							194		
	5 valves	150	139.5	181							212		
	6 valves	168	157.5	199							230		
	7 valves	186	175.5	217							248		
	8 valves	204	193.5	235							266		

Datasheet

Dimensions

Download CAD data → www.festo.com

Valve terminal with multi-pin plug connection – CPV10/14/18

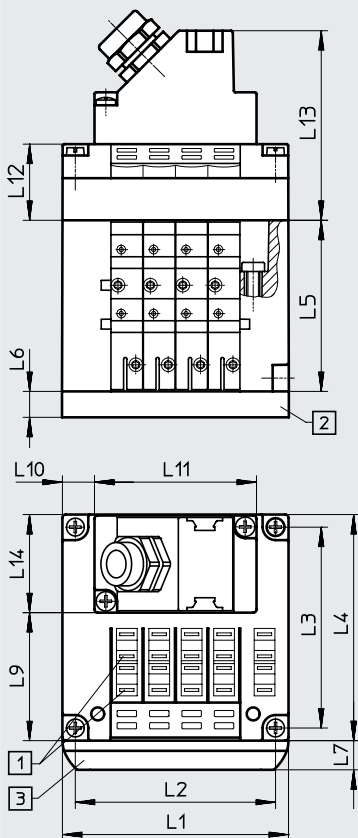

- [1] Slots for inscription labels
- [2] Pneumatic multiple connector plate
- [3] Holder for inscription labels (CPV10/14/18-VI-BZ-T... or CPV10/14/18-VI-ST-T...)

Valve terminal with AS-Interface connection – CPV10/14/18

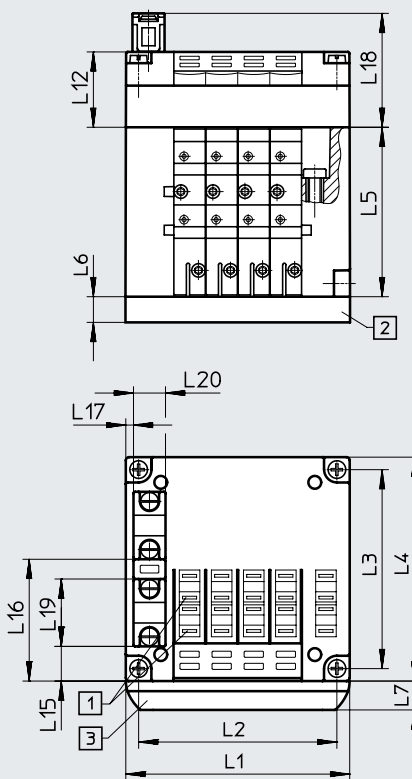

- [1] Slots for inscription labels
- [2] Pneumatic multiple connector plate
- [3] Holder for inscription labels (CPV10/14/18-VI-BZ-T... or CPV10/14/18-VI-ST-T...)

Multi-pin plug connection

		L1	L2	L3	L4	L5	L6	L7	L9	L10	L11	L12	L13	L14
CPV10	4 valves	70	61.8	62	71	52.8	15	9.5	39.5	10	50	23.5	58.8	30
	6 valves	90	81.8							10	70			
	8 valves	110	101.8							20	70			
CPV14	4 valves	96	86	78	89	58.8	20	9.5	61.8	23	50	23.5	58.8	30
	6 valves	124	114							27	70			
	8 valves	152	142							41	70			
CPV18	4 valves	132	121.5	106.5	118	73	20	9.5	88.4	41	50	28	63	30
	6 valves	168	157.5							49	70			
	8 valves	204	193.5							67	70			

AS-Interface connection

		L1	L2	L3	L4	L5	L6	L7	L12	L15	L16	L17	L18	L19	L20
CPV10	2 valves	50	41.8	62	71	52.8	15	9.5	–	10.9	38.1	2.5	35.5	21	10
	4 valves	70	61.8						23.5						
	8 valves	110	101.8						–						
CPV14	2 valves	68	58	78	89	58.8	20	9.5	–	14	52	5	35.5	21	10
	4 valves	96	86						23.5						
	8 valves	152	142						–						
CPV18	2 valves	96	85.5	106.5	118	73	20	9.5	–	27.4	68.2	10.4	40	21	10
	4 valves	132	121.5						28						
	8 valves	204	193.5						–						

Datasheet

Dimensions

Valve terminal with AS-Interface connection and additional inputs – CPV10/14

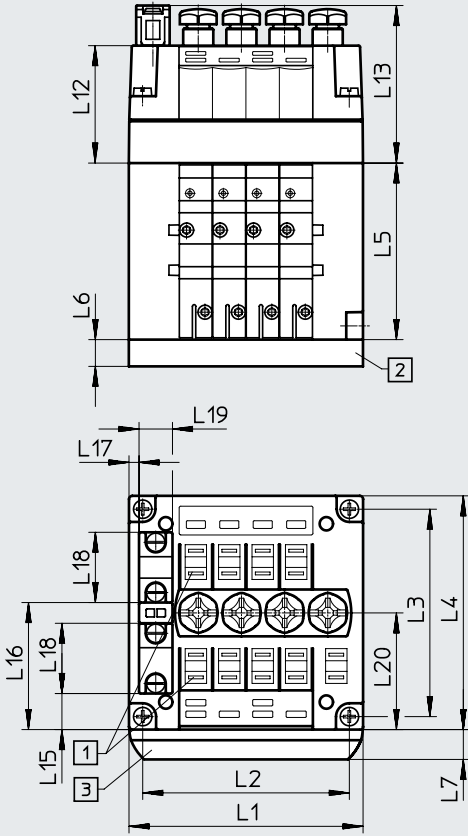

- [1] Slots for inscription labels
- [2] Pneumatic multiple connector plate
- [3] Holder for inscription labels (CPV10/14/18-VI-BZ-T... or CPV10/14/18-VI-ST-T...)

Download CAD data → www.festo.com

Valve terminal with AS-Interface connection and additional inputs – CPV10

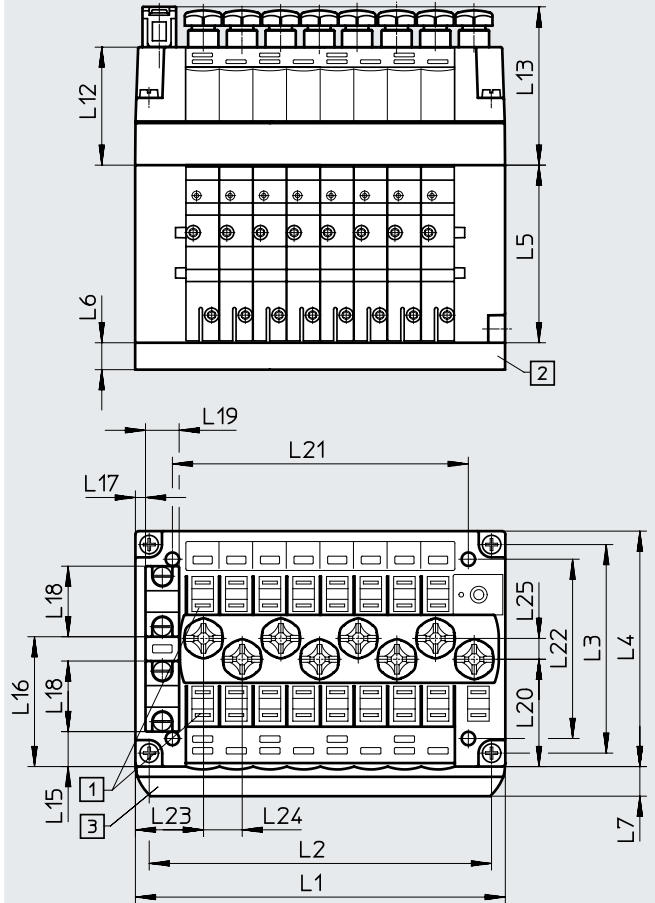

- [1] Slots for inscription labels
- [2] Pneumatic multiple connector plate
- [3] Holder for inscription labels (CPV10/14/18-VI-BZ-T... or CPV10/14/18-VI-ST-T...)

		L1	L2	L3	L4	L5	L6	L7	L12	L13	L15	L16	L17
CPV10	4 valves	70	61.8	62	71	52.8	15	9.5	35.1	47.1	10.9	38.1	3
	8 valves	110	101.8								10.4	38.6	3
CPV14	4 valves	96	86	78	89	58.8	20				18.8	46.8	5

		L18	L19	L20	L21	L22	L23	L24	L25
CPV10	4 valves	21	10	35	-	-	-	-	-
	8 valves			31.9	88	53.3	20.3	11.5	6.2
CPV14	4 valves			43.3	-	-	-	-	-

Datasheet

Dimensions

Download CAD data → www.festo.com

Valve terminal with AS-Interface connection and additional inputs – CPV14

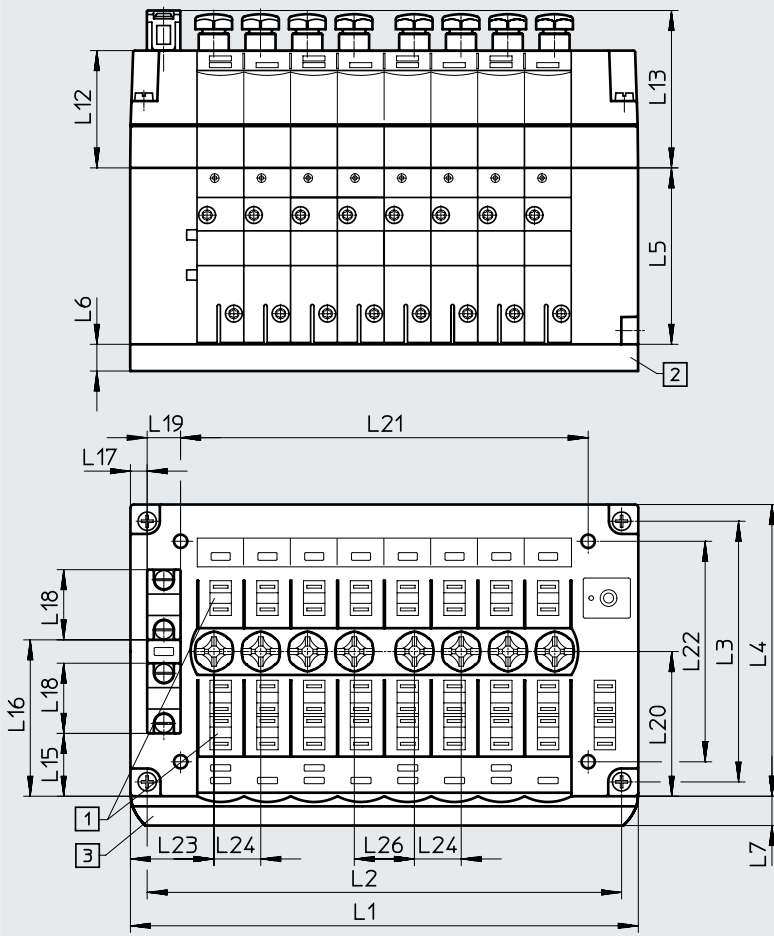

- [1] Slots for inscription labels
- [2] Pneumatic multiple connector plate
- [3] Holder for inscription labels (CPV10/14/18-VI-BZ-T... or CPV10/14/18-VI-ST-T...)

		L1	L2	L3	L4	L5	L6	L7	L12	L13	L15
CPV14	8 valves	152	142	78	89	58.8	20	9.5	35.1	47.1	18.8

		L16	L17	L18	L19	L20	L21	L22	L23	L24	L26
CPV14	8 valves	46.8	5	21	10	46.3	122	66	25	14	18

Datasheet

Dimensions

Download CAD data → www.festo.com

Valve terminal with installation system CPI – CPV10/14

Valve terminal with I-Port interface/IO-Link® – CPV10/14

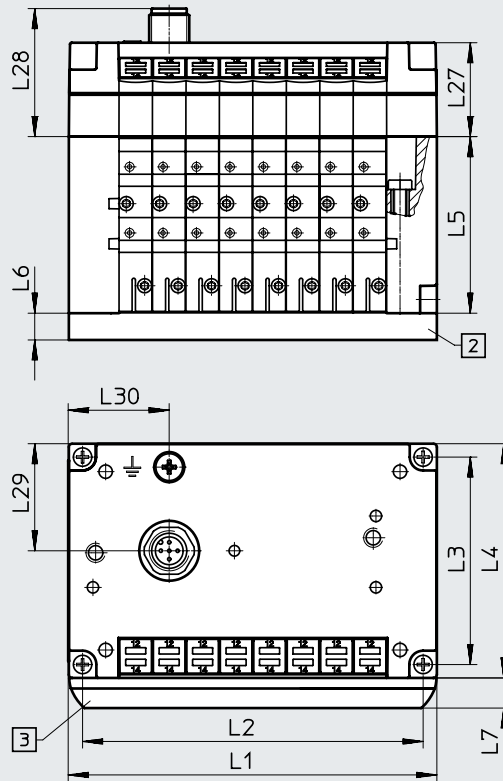
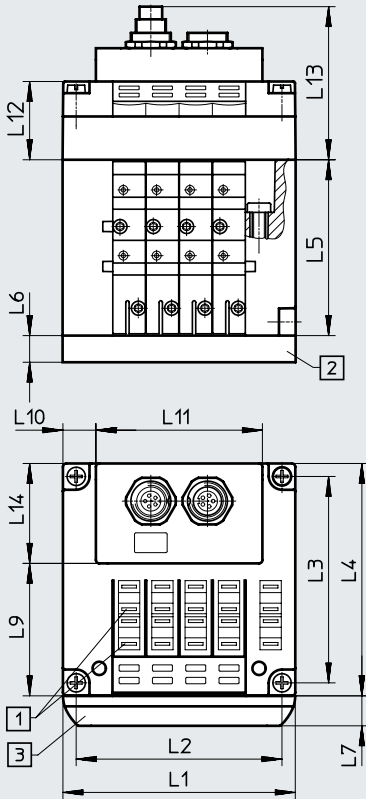

- [1] Slots for inscription labels
- [2] Pneumatic multiple connector plate

- [3] Holder for inscription labels (CPV10/14-VI-BZ-T... or CPV10/14-VI-ST-T...)

- [1] Slots for inscription labels
- [2] Pneumatic multiple connector plate

- [3] Holder for inscription labels

Valve terminal with installation system CPI

		L1	L2	L3	L4	L5	L6	L7	L9	L10	L11	L12	L13	L14
CPV10	4 valves	70	61.8	62	71	52.8	15	9.5	39.5	13.5	43	23.5	46	30
	6 valves	90	81.8							17	56			
	8 valves	110	101.8							27	56			
CPV14	4 valves	96	86	78	89	58.8	20	9.5	61.8	20	56	23.5	46	30
	6 valves	124	114							34				
	8 valves	152	142							48				

Valve terminal with I-Port interface/IO-Link®

		L1	L2	L3	L4	L5	L6	L7	L27	L28	L29	L30
CPV10	8 valves	110	101.8	62	71	52.8	15	9.5	26.2	38.3	32	30.2
CPV14	8 valves	152	142	78	89	58.8	20	9.5	26.2	38.3	32.4	56.5

Datasheet

Dimensions

Download CAD data → www.festo.com

Valve terminal with Fieldbus Direct – CPV10/14/18

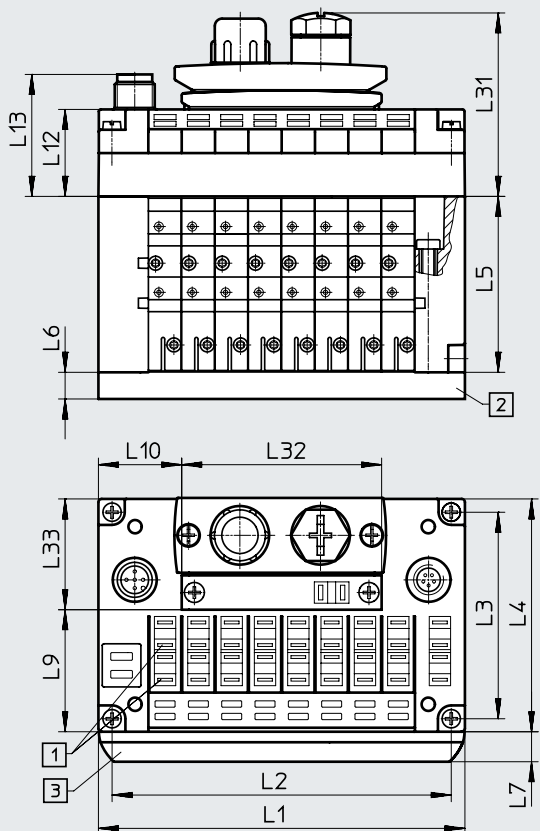

- [1] Slots for inscription labels
- [2] Pneumatic multiple connector plate
- [3] Holder for inscription labels (CPV10/14/18-VI-BZ-T... or CPV10/14/18-VI-ST-T...)

		L1	L2	L3	L4	L5	L6	L7	L9
CPV10	8 valves	110	101.8	62	71	52.8	15	9.5	35.8
CPV14	8 valves	152	142	78	89	58.8	20		52.8
CPV18	8 valves	204	193.5	106.5	118	73	20		79.8

		L10	L11	L12	L13	L14	L27	L31	L32	L33
CPV10	8 valves	25	64	26.2	36.7	45	30.9	55.1	60	34.6
CPV14	8 valves	46		26.2	36.7		30.9	55.1		34.6
CPV18	8 valves	72		31.2	41.7		35.9	59.6		36.6

Datasheet

Dimensions

Download CAD data → www.festo.com

Valve terminal with Fieldbus Direct – CPV10/14/18
PROFIBUS DP

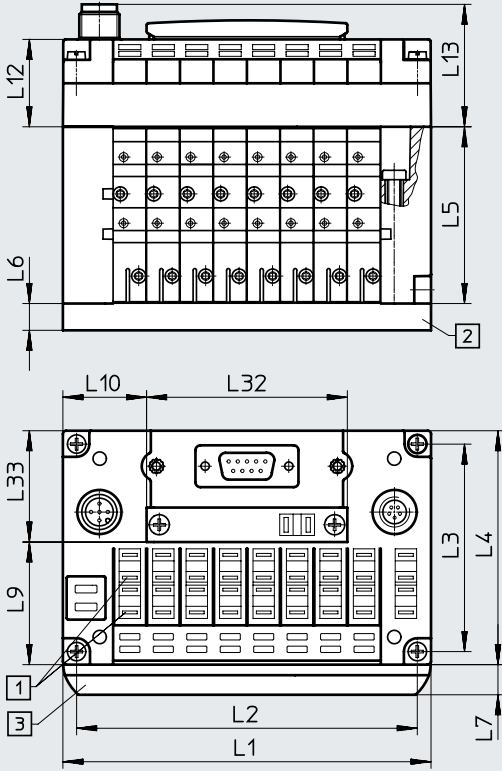

- [1] Slots for inscription labels
- [2] Pneumatic multiple connector plate
- [3] Holder for inscription labels (CPV10/14/18-VI-BZ-T... or CPV10/14/18-VI-ST-T...)

		L1	L2	L3	L4	L5	L6	L7	L9	L10	L12	L13	L32	L33
CPV10	8 valves	110	101.8	62	71	52.8	15	9.5	35.5	25	26.2	36.7	60	34.6
CPV14	8 valves	152	142	78	89	58.8	20		52.8	46	26.2	36.7		34.6
CPV18	8 valves	204	193.5	106.5	118	73	20		79.8	72	31.2	41.7		36.6

Datasheet

Dimensions

Download CAD data → www.festo.com

Wall mounting CPV10/14-VI-BG-RWL-B for CPV10/14

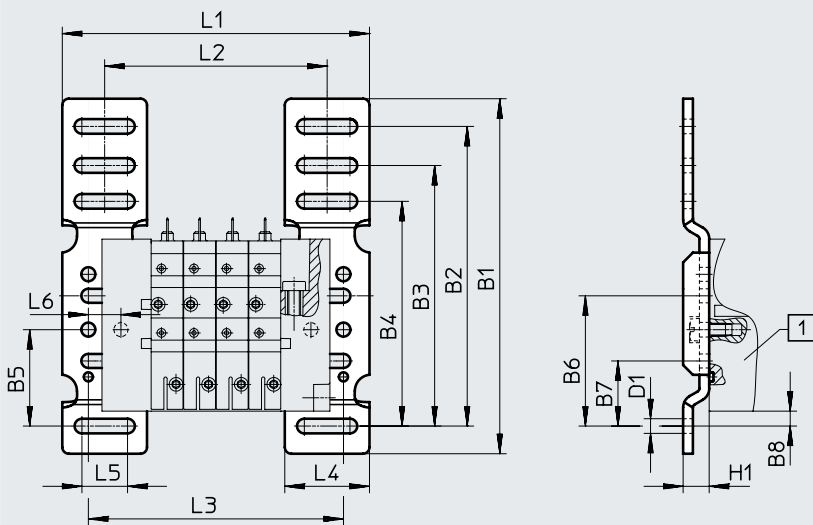

[1] Valve terminal CPV-...

	CPV10								CPV14							
	2 valves	3 valves	4 valves	5 valves	6 valves	7 valves	8 valves	2 valves	3 valves	4 valves	5 valves	6 valves	7 valves	8 valves		
L1	74	84	94	104	114	124	134	90	104	118	132	146	160	174		
L2	48	58	68	78	88	98	108	64	78	92	106	120	134	148		
L3	58	68	78	88	98	108	118	74	88	102	116	130	144	158		

	B1	B2	B3	B4	B5	B6	B7	B8	D1	H1	L4	L5	L6
CPV10	109	92	80	69	29.6	40	20	4.6	4.5	8	26	14	10
CPV14													

Wall mounting CPV18-VI-BG-RW for CPV18

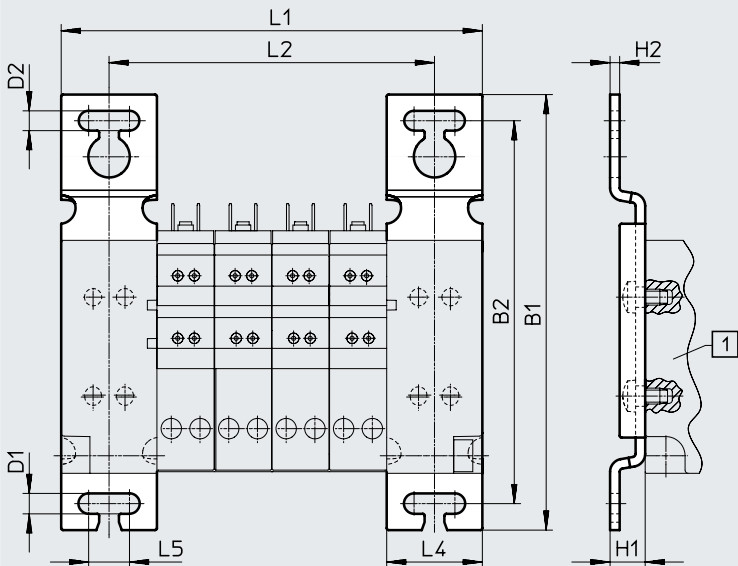

[1] Valve terminal CPV-...

	CPV18							
	2 valves	3 valves	4 valves	5 valves	6 valves	7 valves	8 valves	
L1	96	114	132	150	168	186	204	
L2	66	84	102	120	138	156	174	

	B1	B2	D1	D2	H1	H2	L4	L5
CPV18	136.5	120	6.4	6.2	11	3	30	12.8

Datasheet

Dimensions

Download CAD data → www.festo.com

Mounting CPV10-VI-BG-ET200X for individual connection and ET200X

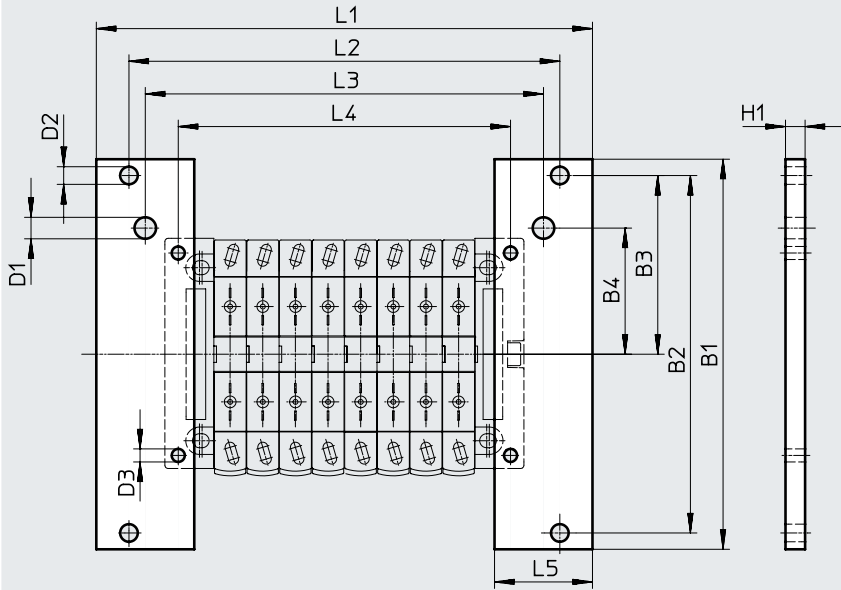

	B1	B2	B3	B4	D1	D2	D3	H1	L1	L2	L3	L4	L5
CPV10	119.5	109.5	54.8	38.7	6.6	5.4	4	6	152	132	122	101.8	30

Mounting CPV14-VI-BG-ET200X for individual connection and ET200X

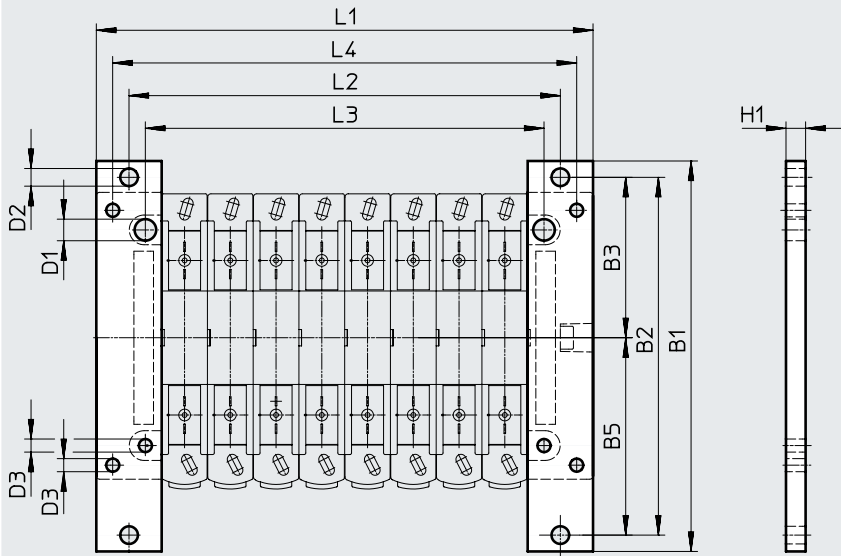

	B1	B2	B3	B5	D1	D2	D3	H1	L1	L2	L3	L4
CPV14	119.5	109.5	49.1	60.4	6.6	5.4	4	6	152	132	122	142

Datasheet

Dimensions

Download CAD data → www.festo.com

Attachment for H-rail mounting CPV10/14-VI-BG-NRH-35

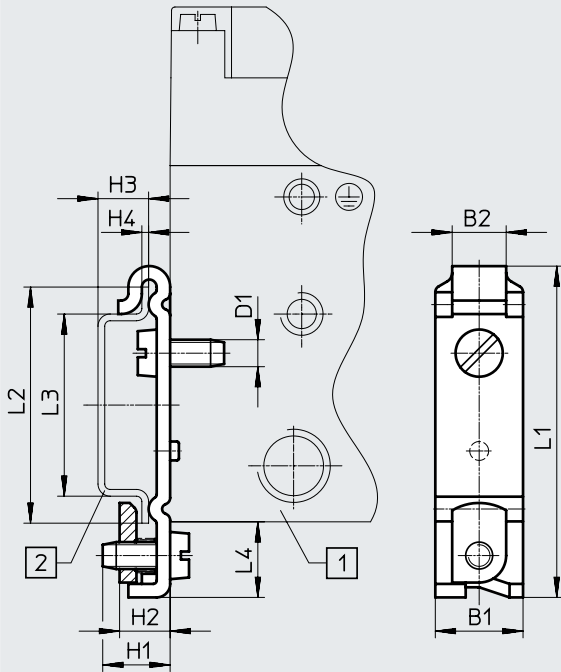

[1] Valve terminal CPV10/14
[2] H-rail to EN 60715

	B1 ±0.1	B2	D1	H1	H2	H3 -0.1	H4 ±0.1	L1	L2 ±0.1	L3 ±0.1	L4
CPV10/14	13	8	M4	10	7.5	7.5	1	49.1	35	27	11.2

Attachment for H-rail mounting CPV18-VI-BG-NRH-35

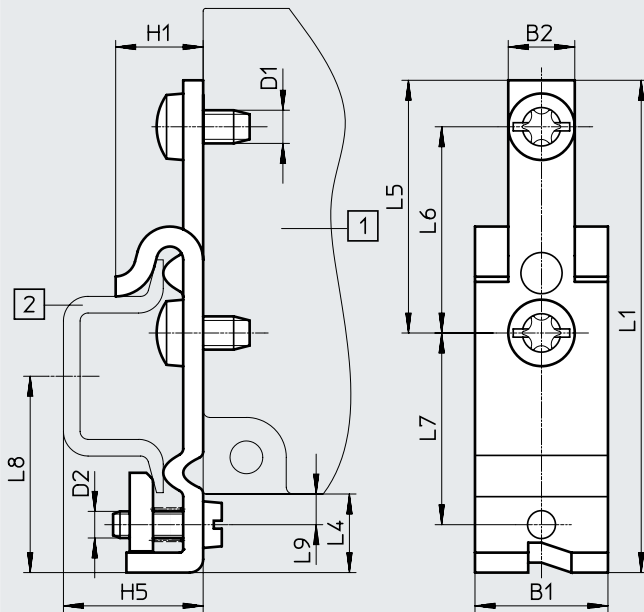

[1] Valve terminal CPV18
[2] H-rail to EN 60715

	B1	B2	D1	D2	H1	H5	L1	L4	L5	L6	L7	L8	L9
CPV18	20	10	M5	M4	13.1	21	74	11.8	38	31	28.8	29.5	4.6

Datasheet

Dimensions

Download CAD data → www.festo.com

Pneumatic multiple connector plate – CPV10/14/18

Pneumatic multiple connector plate with flange – CPV10/14/18

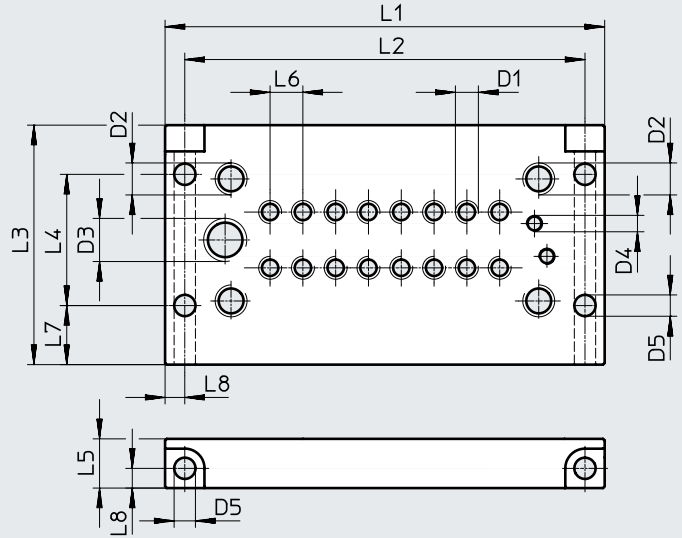
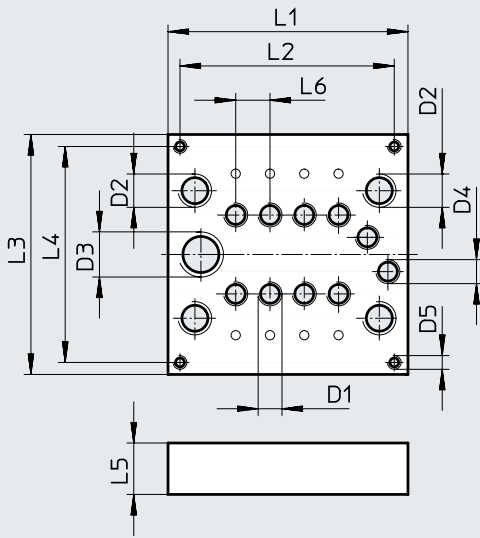

Multi-pin plug

		L1	L2	L3	L4	L5	L6	D1	D2	D3	D4	D5
CPV10	2 valves	49.5	42.5	70	63	15	10	M7	G1/8	G1/4	M7	M4
	4 valves	69.5	62.5									
	6 valves	89.5	82.5									
	8 valves	109.5	102.5									
CPV14	2 valves	67.5	53.5	86.6	76.6	20	14	G1/8	G1/4	G3/8	G1/8	M4
	4 valves	95.5	81.5									
	6 valves	123.5	109.5									
	8 valves	151.5	137.5									
CPV18	2 valves	95.5	87.5	119.6	108	20	18	G1/4	G3/8	G1/2	G1/4	M5
	4 valves	131	123									
	6 valves	167	159									
	8 valves	203	195									

Multiple connector plate with flange

		L1	L2	L3	L4	L5	L6	L7	L8	D1	D2	D3	D4	D5
CPV10	2 valves	74	62	73	40	15	10	18	6	M7	G1/8	G1/4	M5	6.5
	4 valves	94	82											
	6 valves	114	102											
	8 valves	134	122											
CPV14	2 valves	92	80	89	59	20	14	18	6	G1/8	G1/4	G3/8	G1/8	6.5
	4 valves	120	108											
	6 valves	148	136											
	8 valves	176	164											
CPV18	2 valves	119	107	118	88	20	18	18	6	G1/4	G3/8	G1/2	G1/4	6.5
	4 valves	155	143											
	6 valves	191	179											
	8 valves	227	215											

Datasheet

Dimensions

Download CAD data → www.festo.com

Pneumatic multiple connector plate for control cabinet installation, without supply ports – CPV10/14

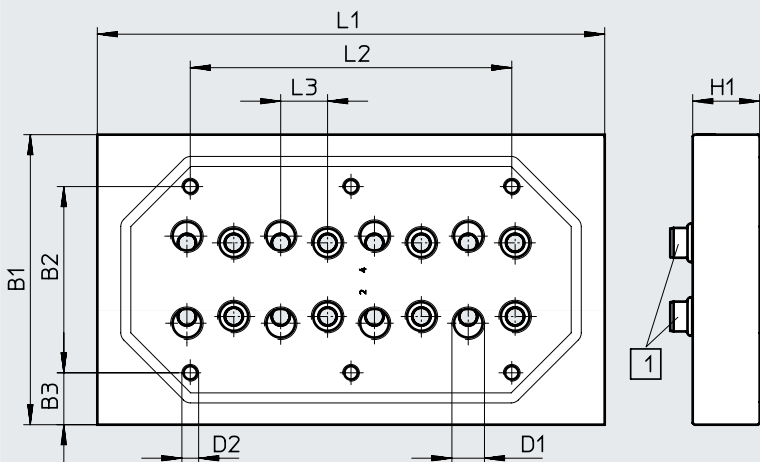

[1] Seal

		L1	L2	L3	B1	B2	B3	D1	D2	H1
CPV10	2 valves	49.5	–	10	70	40	15	M7	M5	15
	4 valves	69.5	28							
	6 valves	89.5	49							
	8 valves	109.5	68							
CPV14	2 valves	67.5	13	14	86.6	55.6	15.5	G1/8	M5	20
	4 valves	95.5	40							
	6 valves	123.5	68							
	8 valves	151.5	96							

Pneumatic multiple connector plate for control cabinet installation, with supply ports – CPV10/14

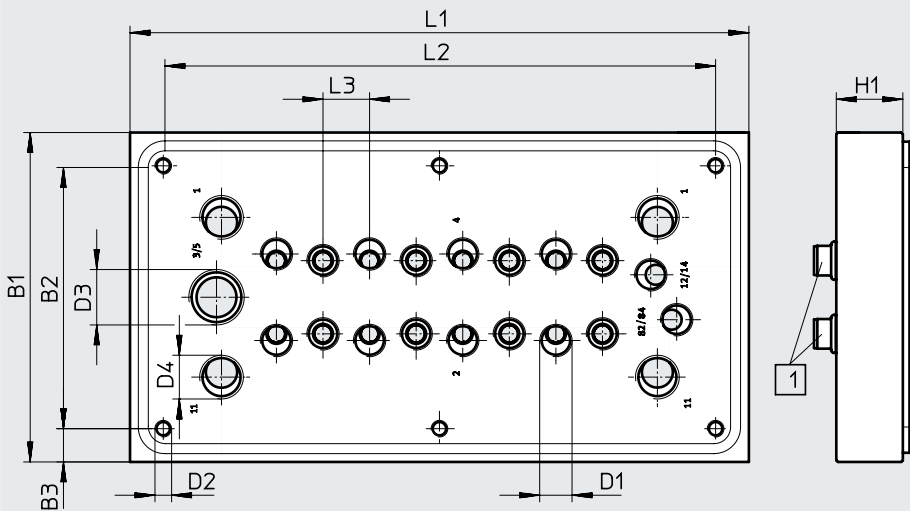

[1] Seal

		L1	L2	L3	B1	B2	B3	D1	D2	D3	D4	H1
CPV10	2 valves	82	62	10	84	64	10	M7	M5	G1/4	G1/8	15
	4 valves	102	82									
	6 valves	122	102									
	8 valves	142	122									
CPV14	2 valves	102	82	14	99	79	10	G1/8	M5	G3/8	G1/4	20
	4 valves	130	110									
	6 valves	158	138									
	8 valves	186	166									

Datasheet

Dimensions

Download CAD data → www.festo.com

Pneumatic multiple connector plate for control cabinet installation, with all ports – CPV10

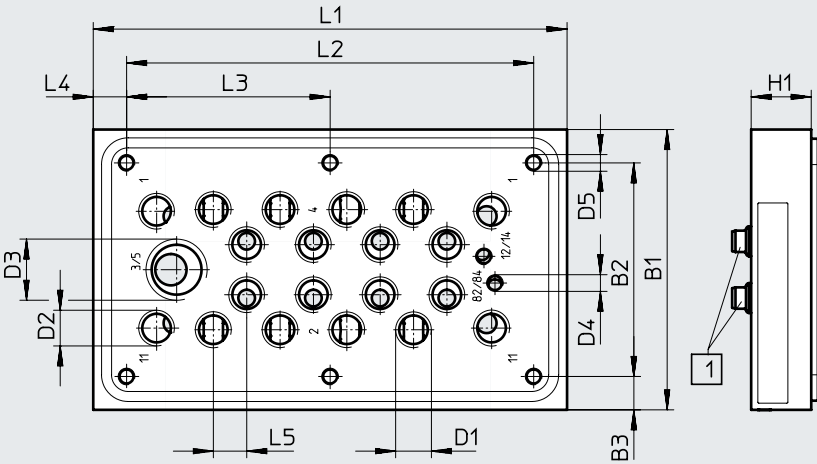

[1] Seal

		L1	L2	L3	L4	L5	B1	B2	B3	D1	D2	D3	D4	D5	H1
CPV10	2 valves	82	62	-	10	10	84	64	10	G1/8	G1/8	G3/8	M5	M5	18
	4 valves	102	82	45.55											
	6 valves	122	102	61											
	8 valves	142	122	61											

Datasheet

Dimensions

Download CAD data → www.festo.com

Valve kit for 5/3 function – CPV10/14

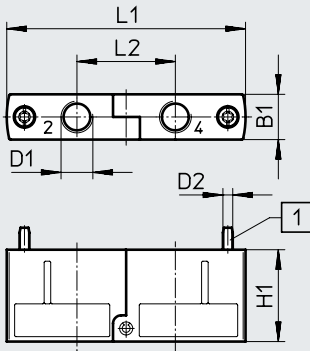

[1] Retaining screw enclosed separately

Type	B1	D1	D2	H1	L1	L2
CPV10-BS-5/3G-M7	9.9	M7	M2.5	22	55.8	23
CPV14-BS-5/3G-1/8	13.8	G1/8	M3	28	72.8	30

Additional one-way flow control valve function – CPV10/14

CPV10/14-...-BS-2xGR...-...

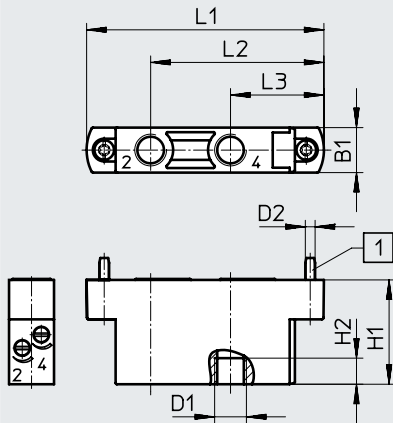

[1] Retaining screw enclosed separately

Additional one-way flow control valve function for vacuum – CPV10/14

CPV...-BS-2xGRZ-V-...

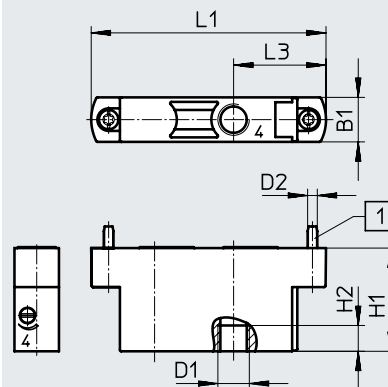

Type	B1	D1	D2	H1	H2	L1	L2	L3
CPV10-BS-2xGR...-M7	9.9	M7	M2.5	26	6	55.8	41.4	22.9
CPV10-BS-2xGRZ-V...-M7							-	
CPV14-BS-2xGR...-1/8	13.8	G1/8	M3	32	8	72.8	53.15	28.65
CPV14-BS-2xGRZ-V...-1/8							-	

Datasheet

Dimensions

Fieldbus interface FBS-SUB-9-GS-DP-B

Download CAD data → www.festo.com

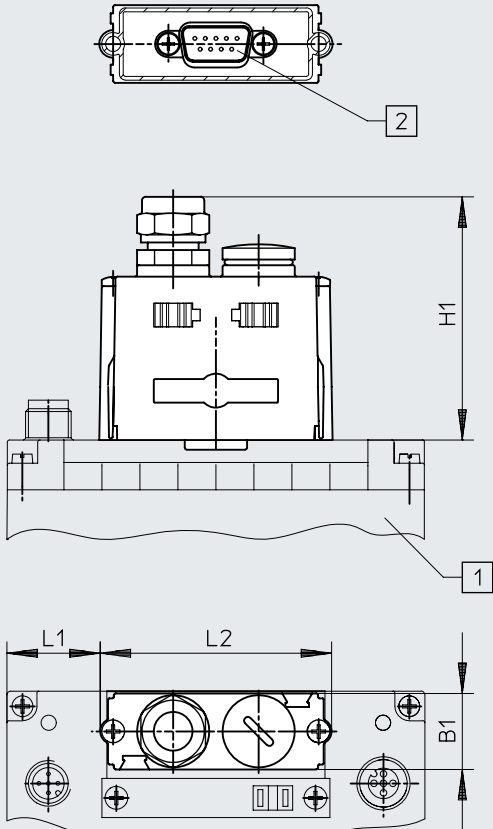

[1] Valve terminal with Fieldbus Direct CPV10/14/18 and bus node
 [2] Sub-D socket, 9-pin

FBS	CPV10 8 valves	CPV14 8 valves	CPV18 8 valves
B1	20	20	20
H1	64	64	64
H2	-	-	-
L1	24.5	45.5	71.5
L2	61	61	61

Accessories

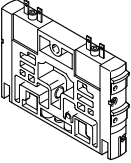
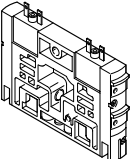
Ordering data					
	Code	Valve function	Product weight [g]	Part no.	Type
Individual sub-base valve, size 10/14/18					
	M	5/2-way valve, single solenoid, piston spool valve	70	161414	CPV10-M1H-5LS-M7
			120	161360	CPV14-M1H-5LS-1/8
			260	163190	CPV18-M1H-5LS-1/4
	F	5/2-way valve, single solenoid, fast switching, piston spool valve	70	187439	CPV10-M11H-5LS-M7
			120	161415	CPV10-M1H-5JS-M7
			260	163191	CPV18-M1H-5JS-1/4
	J	5/2-way valve, double solenoid, piston spool valve	70	161415	CPV10-M1H-5JS-M7
			120	161361	CPV14-M1H-5JS-1/8
			260	163191	CPV18-M1H-5JS-1/4
	N	2x 3/2-way valve, normally open, piston spool valve	70	161417	CPV10-M1H-2x3-OLS-M7
			120	161363	CPV14-M1H-2x3-OLS-1/8
			260	163188	CPV18-M1H-2x3-OLS-1/4
	C	2x 3/2-way valve, normally closed, piston spool valve	70	161416	CPV10-M1H-2x3-GLS-M7
			120	161362	CPV14-M1H-2x3-GLS-1/8
			260	163189	CPV18-M1H-2x3-GLS-1/4
	CY	2x 3/2-way valve, normally closed, integrated back pressure protection, piston spool valve	70	553260	CPV10-M1H-2x3-GLS-Y-M7
	H	2x 3/2-way valve, 1x normally open, 1x normally closed, piston spool valve	70	176064	CPV10-M1H-30LS-3GLS-M7
			120	176067	CPV14-M1H-30LS-3GLS-1/8
			260	176070	CPV18-M1H-30LS-3GLS-1/4
	G	5/3-way valve, mid-position closed, piston spool valve	260	176061	CPV18-M1H-5/3GS-1/4
	D	2x 2/2-way valve, normally closed, piston spool valve	70	185880	CPV10-M1H-2x2-GLS-M7
120			185883	CPV14-M1H-2x2-GLS-1/8	
260			185886	CPV18-M1H-2x2-GLS-1/4	
I	2x 2/2-way valve, 1x normally open, 1x normally closed, piston spool valve	70	187843	CPV10-M1H-20LS-2GLS-M7	
		120	187846	CPV14-M1H-20LS-2GLS-1/8	
		260	187849	CPV18-M1H-20LS-2GLS-1/4	
Individual sub-base valve with duct separation 1, 11 sizes 10/14					
	MK	5/2-way valve (with duct separation 1, 11), single solenoid, piston spool valve	70	553256	CPV10-M1H-5LS-K-M7
			120	553258	CPV14-M1H-5LS-K-1/8
	JK	5/2-way valve (with duct separation 1, 11), double solenoid, piston spool valve	70	559644	CPV10-M1H-5JS-K-M7
			120	559651	CPV14-M1H-5JS-K-1/8
	NK	2x 3/2-way valve (with duct separation 1, 11), normally open, piston spool valve	70	559641	CPV10-M1H-2x3-OLS-K-M7
			120	559648	CPV14-M1H-2x3-OLS-K-1/8
	CK	2x 3/2-way valve (with duct separation 1, 11) normally closed, piston spool valve	70	553257	CPV10-M1H-2x3-GLS-K-M7
			120	553259	CPV14-M1H-2x3-GLS-K-1/8
	HK	2x 3/2-way valve (with duct separation 1, 11), 1x normally open, 1x normally closed, piston spool valve	70	559642	CPV10-M1H-30LS-3GLS-K-M7
			120	559649	CPV14-M1H-30LS-3GLS-K-1/8
	DK	2x 2/2-way valve (with duct separation 1, 11), normally closed, piston spool valve	70	559645	CPV10-M1H-2x2-GLS-K-M7
			120	559652	CPV14-M1H-2x2-GLS-K-1/8
	IK	2x 2/2-way valve (with duct separation 1, 11), 1x normally open, 1x normally closed, piston spool valve	70	559646	CPV10-M1H-20LS-2GLS-K-M7
			120	559653	CPV14-M1H-20LS-2GLS-K-1/8

Accessories

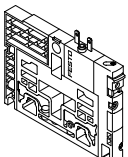
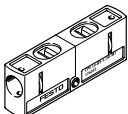
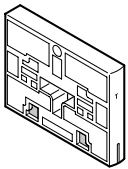
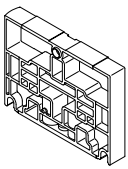
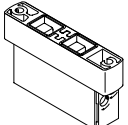
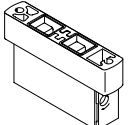
Ordering data					
	Code	Designation	Product weight [g]	Part no.	Type
Vacuum generator					
	A	Vacuum generator	25	185862	CPV10-M1H-V70-M7
			98	185868	CPV14-M1H-V95-1/8
			227	185874	CPV18-M1H-V140-1/4
	E	Vacuum generator with ejector pulse	25	185865	CPV10-M1H-VI70-2GLS-M7
			114	185871	CPV14-M1H-VI95-2GLS-1/8
			264	185877	CPV18-M1H-VI140-2GLS-1/4
Function block					
	G	Valve kit for 5/3-way valve function, closed (in combination with valve slice C) for size 10 and 14	23	176055	CPV10-BS-5/3G-M7
			190	176057	CPV14-BS-5/3G-1/8
Separator plates					
	T	Separator plate, duct 1/11 closed	25	161369	CPV10-DZP
			–	162551	CPV14-DZP
			25	163282	CPV18-DZP
	S	Separator plate, duct 1/11, 3/5 closed	25	178678	CPV10-DZPR
			–	178680	CPV14-DZPR
			–	184543	CPV18-DZPR
Blanking plate					
	L	Blanking plate	25	161368	CPV10-RZP
				162550	CPV14-RZP
				163283	CPV18-RZP
Additional functions for valve positions					
	P	One-way flow control valve, 2x supply air	30	184140	CPV10-BS-2XGRZZ-M7
			54	184142	CPV14-BS-2XGRZZ-1/8
	Q	One-way flow control valve, 2x exhaust air	30	184141	CPV10-BS-2XGRAZ-M7
			54	184143	CPV14-BS-2XGRAZ-1/8
	V	One-way flow control valve for vacuum	30	185889	CPV10-BS-GRZ-V-M7
			–	185891	CPV14-BS-GRZ-V-1/8

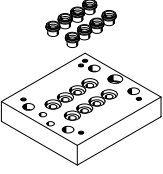

Accessories

Ordering data		Code	Designation	Product weight [g]	Part no.	Type
Pneumatic multiple connector plate						
	M	Pneumatic multiple connector plate, for wall/machine mounting, without side flange	2 valves	135	161969	CPV10-VI-P2-M7
			4 valves	164	161970	CPV10-VI-P4-M7
			6 valves	219	161971	CPV10-VI-P6-M7
			8 valves	272	163893	CPV10-VI-P8-M7
			2 valves	261	163894	CPV14-VI-P2-1/8
			4 valves	379	163895	CPV14-VI-P4-1/8
			6 valves	505	163896	CPV14-VI-P6-1/8
			8 valves	627	163897	CPV14-VI-P8-1/8
			2 valves	519	165292	CPV18-VI-P2-1/4
			4 valves	695	165293	CPV18-VI-P4-1/4
			6 valves	907	165294	CPV18-VI-P6-1/4
			8 valves	1116	165295	CPV18-VI-P8-1/4
	P	Pneumatic multiple connector plate, for wall/machine mounting, with side flange	2 valves	182	152420	CPV10-VI-P2-M7-B
			4 valves	228	152421	CPV10-VI-P4-M7-B
			6 valves	283	152422	CPV10-VI-P6-M7-B
			8 valves	336	152423	CPV10-VI-P8-M7-B
			2 valves	365	152424	CPV14-VI-P2-1/8-B
			4 valves	483	152425	CPV14-VI-P4-1/8-B
			6 valves	609	152426	CPV14-VI-P6-1/8-B
			8 valves	731	152427	CPV14-VI-P8-1/8-B
			2 valves	659	175632	CPV18-VI-P2-1/4-B
			4 valves	832	175634	CPV18-VI-P4-1/4-B
			6 valves	1047	175636	CPV18-VI-P6-1/4-B
			8 valves	1256	175638	CPV18-VI-P8-1/4-B
	GQC	Pneumatic multiple connector plate with sealing ring, for control cabinet assembly, with supply ports	2 valves	250	538807	CPV10-VI-P2-M7-C
			4 valves	320	538808	CPV10-VI-P4-M7-C
			6 valves	390	538809	CPV10-VI-P6-M7-C
			8 valves	460	538810	CPV10-VI-P8-M7-C
			2 valves	500	539498	CPV14-VI-P2-1/8-C
			4 valves	650	539499	CPV14-VI-P4-1/8-C
			6 valves	800	539500	CPV14-VI-P6-1/8-C
			8 valves	920	539501	CPV14-VI-P8-1/8-C
GQD	Pneumatic multiple connector plate with sealing ring, for control cabinet assembly, without supply ports	2 valves	80	538811	CPV10-VI-P2-M7-D	
		4 valves	150	538812	CPV10-VI-P4-M7-D	
		6 valves	220	538813	CPV10-VI-P6-M7-D	
		8 valves	290	538814	CPV10-VI-P8-M7-D	
		2 valves	350	539502	CPV14-VI-P2-1/8-D	
		4 valves	550	539503	CPV14-VI-P4-1/8-D	
		6 valves	400	539504	CPV14-VI-P6-1/8-D	
		8 valves	650	539505	CPV14-VI-P8-1/8-D	
GQE	Pneumatic multiple connector plate with sealing ring, for control cabinet assembly, with all ports	2 valves	300	566709	CPV10-VI-P2-1/8-C	
		4 valves	370	566710	CPV10-VI-P4-1/8-C	
		6 valves	440	566711	CPV10-VI-P6-1/8-C	
		8 valves	510	566712	CPV10-VI-P8-1/8-C	

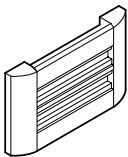
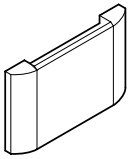
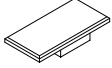
Accessories

Ordering data		Code	Designation	Product weight [g]	Part no.	Type
Inscription label holders						
	Z	Holder for inscription labels	32	162560	CPV10-VI-BZ-T-2	
			33	162561	CPV10-VI-BZ-T-3	
			34	162562	CPV10-VI-BZ-T-4	
			35	162563	CPV10-VI-BZ-T-5	
			36	162564	CPV10-VI-BZ-T-6	
			37	162565	CPV10-VI-BZ-T-7	
			38	162566	CPV10-VI-BZ-T-8	
			8	162567	CPV14-VI-BZ-T-2	
			9.5	162568	CPV14-VI-BZ-T-3	
			11	162569	CPV14-VI-BZ-T-4	
			12.5	162570	CPV14-VI-BZ-T-5	
			14	162571	CPV14-VI-BZ-T-6	
			15.5	162572	CPV14-VI-BZ-T-7	
			17	162573	CPV14-VI-BZ-T-8	
			9	163293	CPV18-VI-BZ-T-2	
			10.5	163294	CPV18-VI-BZ-T-3	
			12	163295	CPV18-VI-BZ-T-4	
			13.5	163296	CPV18-VI-BZ-T-5	
16	163297	CPV18-VI-BZ-T-6				
17.5	163298	CPV18-VI-BZ-T-7				
29	163299	CPV18-VI-BZ-T-8				
	T	Holder for inscription labels, transparent	11	194066	CPV10-VI-ST-T-2	
			14	194067	CPV10-VI-ST-T-3	
			17	194068	CPV10-VI-ST-T-4	
			20	194069	CPV10-VI-ST-T-5	
			23	194070	CPV10-VI-ST-T-6	
			24	194071	CPV10-VI-ST-T-7	
			29	194072	CPV10-VI-ST-T-8	
			-	194073	CPV14-VI-ST-T-2	
			18	194074	CPV14-VI-ST-T-3	
			22	194075	CPV14-VI-ST-T-4	
			25	194076	CPV14-VI-ST-T-5	
			53	194077	CPV14-VI-ST-T-6	
			59	194078	CPV14-VI-ST-T-7	
			63	194079	CPV14-VI-ST-T-8	
			17	194080	CPV18-VI-ST-T-2	
			23	194081	CPV18-VI-ST-T-3	
			29	194082	CPV18-VI-ST-T-4	
			35	194083	CPV18-VI-ST-T-5	
41	194084	CPV18-VI-ST-T-6				
47	194085	CPV18-VI-ST-T-7				
53	194086	CPV18-VI-ST-T-8				
Inscription labels						
	-	6x10 mm in frame, 64 pieces	-	18576	IBS 6x10	
		9x20 mm in frames, 20 pieces (CPV18 only)	-	18182	IBS 9x20	

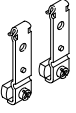
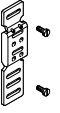
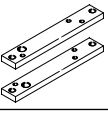

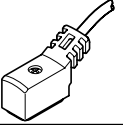
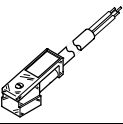
Accessories



Ordering data		Code	Designation	Product weight [g]	Part no.	Type	
Mounting							
	H	Mounting for H-rail		15.8	162556	CPV10/14-VI-BG-NRH-35	
				50	163291	CPV18-VI-BG-NRH-35	
	W	Attachment for wall mounting	For CPV18	200	163292	CPV18-VI-BG-RW	
	U		For CPV10/14	118	189541	CPV10/14-VI-BG-RWL-B	
	X	Mounting for individual connection and ET200X (included in the scope of delivery)		216	165801	CPV10-VI-BG-ET200X	
				326	165803	CPV14-VI-BG-ET200X	
Manual override							
	-	Locking clip (for manual override), non-detachable		1.5	526203	CPV10/14-HS	
				3	526204	CPV18-HS	
	V	Locking clip (cover for manual override), non-detachable		0.15	530055	CPV10/14-HV	
				0.53	530056	CPV18-HV	
Connecting cable for individual connection, electrical							
	D	Angled socket, plug pattern ZC, self-tapping screw, for CPV10/14		2.5 m	50	8047676	NEBV-Z3WA2L-R-E-2.5-N-LE2-S1
	E			5 m	90	8047677	NEBV-Z3WA2L-R-E-5-N-LE2-S1
	F			10 m	170	8047675	NEBV-Z3WA2L-R-E-10-N-LE2-S1
Plug socket with cable for individual connection, electrical							
	D	For CPV18		2.5 m	200	174844	KMEB-2-24-2.5-LED
	E			5 m	400	174845	KMEB-2-24-5-LED

 **Note**

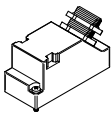
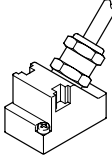
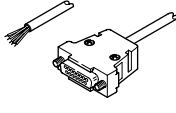

Connecting cables are pre-assembled. They include a protective circuit and an LED for indicating the operating status.

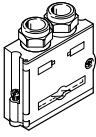
Accessories

Ordering data								
	Code	Designation			Product weight [g]	Part no.	Type	
Multi-pin cable								
	Y	Plug socket (Sub-D plug can be crimped), for assembly by the user	9-pin		73	18708	SD-SUB-D-BU9	
			25-pin		75	18709	SD-SUB-D-BU25	
	R	Connecting cable, IP65, polyvinyl chloride	9-pin		5 m	425	18698	KMP3-9P-08-5
			25-pin			672	18624	KMP3-25P-16-5
			9-pin		10 m	814	18579	KMP3-9P-08-10
			25-pin			1303	18625	KMP3-25P-16-10
	-	Connecting cable, IP65, polyurethane (suitable for energy chains)	9-pin		5 m	378	193014	KMP4-9P-5-PUR
			25-pin			702	193018	KMP4-25P-5-PUR
	-	Connecting cable, IP65, polyurethane (suitable for energy chains)	9-pin		10 m	723	193015	KMP4-9P-10-PUR
			25-pin			1617	193019	KMP4-25P-10-PUR
	-	Connecting cable, IP65, polyvinyl chloride (suitable for energy chains)	9-pin		5 m	413	193012	KMP4-9P-5-PVC
			25-pin			854	193016	KMP4-25P-5-PVC
9-pin			10 m	791	193013	KMP4-9P-10-PVC		
25-pin				1657	193017	KMP4-25P-10-PVC		
	-	Connecting cable, IP40, polyvinyl chloride For CPV10/14/18 only	9-pin		2.5 m	248	531184	KMP6-09P-8-2.5
			25-pin			432	530046	KMP6-25P-20-2.5
			9-pin		5 m	454	531185	KMP6-09P-8-5
			25-pin			814	530047	KMP6-25P-20-5
			9-pin		10 m	864	531186	KMP6-09P-8-10
			25-pin			1600	530048	KMP6-25P-20-10
	-	Threaded sleeve for multi-pin cable KMP6, IP40	-	-	-	572608	NEAU-TA-M35-U4	

Ordering data							
	Code	Designation			Product weight [g]	Part no.	Type
Fieldbus interface for Fieldbus Direct							
	GE	Sub-D plug, IP65, 9-pin for PROFIBUS DP			60	532216	FBS-SUB-9-GS-DP-B
	GF	Bus connection 2x M12 adapter (B-coded, ReverseKey) for PROFIBUS DP			80	533118	FBA-2-M12-5POL-RK

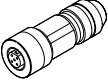
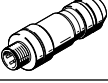
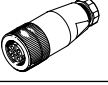
Accessories

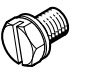
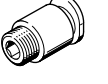
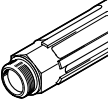
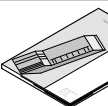
Ordering data		Code	Designation	Product weight [g]	Part no.	Type
Fieldbus interface for Fieldbus Direct						
	–	Socket M12x1, 5-pin, straight, for assembly by the user of a connecting cable for FBA-2-M12-5POL-RK		–	1067905	NECU-M-B12G5-C2-PB
	–	Plug M12x1, 5-pin, straight, for assembly by the user of a connecting cable for FBA-2-M12-5POL-RK		–	1066354	NECU-M-S-B12G5-C2-PB
Operating voltage connection for Fieldbus Direct						
	Straight socket	M12, 4-pin, PG7, IP67	13	18494	SIE-GD	
		M12, 4-pin, PG9, IP67	29	18495	FBSD-GD-9	
	Angled plug socket	M12, 4-pin, IP67	13	12956	SIE-WD-TR	
		M12, 4-pin, PG9, IP67	30	18525	FBSD-WD-9	
Blanking plug						
	Blanking plug		1	3843	B-M5	
			2	174309	B-M7	
			7	3568	B-1/8	
			15	3569	B-1/4	
			23	3570	B-3/8	
			43	3571	B-1/2	
Push-in fitting						
	Push-in fitting		12	186109	QS-G1/8-8-I	
			20	186112	QS-G1/4-10-I	
			34	186114	QS-G3/8-12-I	
			4.4	153317	QSM-M5-6-I	
			6.4	153321	QSM-M7-6-I	
Silencer						
	Silencer		1.5	1205858	AMTE-M-LH-M5	
			43	1205863	AMTE-M-LH-G12	
			13	1205861	AMTE-M-LH-G14	
			7.5	1205860	AMTE-M-LH-G18	
			26	1205862	AMTE-M-LH-G38	
			1.2	161418	UC-M7	
User documentation						
	Description CPV pneumatics	German	–	165100	P.BE-CPV-DE	
		English		165200	P.BE-CPV-EN	
		French		165130	P.BE-CPV-FR	
		Italian		165160	P.BE-CPV-IT	
		Spanish		165230	P.BE-CPV-ES	

ATEX accessories

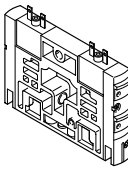
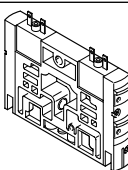
Ordering data					
	Code	Valve function	Product weight [g]	Part no.	Type
Individual sub-base valve, size 10/14/18					
	M	5/2-way valve, single solenoid, piston spool valve	70	161414	CPV10-M1H-5LS-M7
			120	161360	CPV14-M1H-5LS-1/8
			260	163190	CPV18-M1H-5LS-1/4
	F	5/2-way valve, single solenoid, fast switching, piston spool valve	70	187439	CPV10-M11H-5LS-M7
			120	161415	CPV10-M1H-5JS-M7
			260	161361	CPV14-M1H-5JS-1/8
	J	5/2-way valve, double solenoid, piston spool valve	70	161415	CPV10-M1H-5JS-M7
			120	161361	CPV14-M1H-5JS-1/8
			260	163191	CPV18-M1H-5JS-1/4
	N	2x 3/2-way valve, normally open, piston spool valve	70	161417	CPV10-M1H-2x3-OLS-M7
			120	161363	CPV14-M1H-2x3-OLS-1/8
			260	163188	CPV18-M1H-2x3-OLS-1/4
	C	2x 3/2-way valve, normally closed, piston spool valve	70	161416	CPV10-M1H-2x3-GLS-M7
			120	161362	CPV14-M1H-2x3-GLS-1/8
			260	163189	CPV18-M1H-2x3-GLS-1/4
	CY	2x 3/2-way valve, normally closed, integrated back pressure protection, piston spool valve	70	553260	CPV10-M1H-2x3-GLS-Y-M7
	H	2x 3/2-way valve, 1x normally open, 1x normally closed, piston spool valve	70	176064	CPV10-M1H-30LS-3GLS-M7
			120	176067	CPV14-M1H-30LS-3GLS-1/8
			260	176070	CPV18-M1H-30LS-3GLS-1/4
G	5/3-way valve, mid-position closed, piston spool valve	260	176061	CPV18-M1H-5/3GS-1/4	
D	2x 2/2-way valve, normally closed, piston spool valve	70	185880	CPV10-M1H-2x2-GLS-M7	
		120	185883	CPV14-M1H-2x2-GLS-1/8	
		260	185886	CPV18-M1H-2x2-GLS-1/4	
I	2x 2/2-way valve, 1x normally open, 1x normally closed, piston spool valve	70	187843	CPV10-M1H-20LS-2GLS-M7	
		120	187846	CPV14-M1H-20LS-2GLS-1/8	
		260	187849	CPV18-M1H-20LS-2GLS-1/4	
Individual sub-base valve with duct separation 1, 11 sizes 10/14					
	MK	5/2-way valve (with duct separation 1, 11), single solenoid, piston spool valve	70	553256	CPV10-M1H-5LS-K-M7
			120	553258	CPV14-M1H-5LS-K-1/8
	JK	5/2-way valve (with duct separation 1, 11), double solenoid, piston spool valve	70	559644	CPV10-M1H-5JS-K-M7
			120	559651	CPV14-M1H-5JS-K-1/8
	NK	2x 3/2-way valve (with duct separation 1, 11), normally open, piston spool valve	70	559641	CPV10-M1H-2x3-OLS-K-M7
			120	559648	CPV14-M1H-2x3-OLS-K-1/8
	CK	2x 3/2-way valve (with duct separation 1, 11) normally closed, piston spool valve	70	553257	CPV10-M1H-2x3-GLS-K-M7
			120	553259	CPV14-M1H-2x3-GLS-K-1/8
	HK	2x 3/2-way valve (with duct separation 1, 11), 1x normally open, 1x normally closed, piston spool valve	70	559642	CPV10-M1H-30LS-3GLS-K-M7
			120	559649	CPV14-M1H-30LS-3GLS-K-1/8
	DK	2x 2/2-way valve (with duct separation 1, 11), normally closed, piston spool valve	70	559645	CPV10-M1H-2x2-GLS-K-M7
			120	559652	CPV14-M1H-2x2-GLS-K-1/8
	IK	2x 2/2-way valve (with duct separation 1, 11), 1x normally open, 1x normally closed, piston spool valve	70	559646	CPV10-M1H-20LS-2GLS-K-M7
120			559653	CPV14-M1H-20LS-2GLS-K-1/8	

ATEX accessories

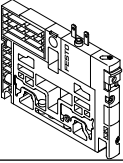
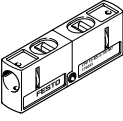
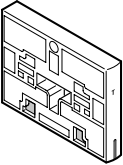
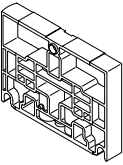
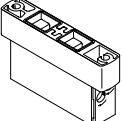
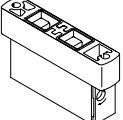
Ordering data					
	Code	Designation	Product weight [g]	Part no.	Type
Vacuum generator					
	A	Vacuum generator	25	185862	CPV10-M1H-V70-M7
			98	185868	CPV14-M1H-V95-1/8
			227	185874	CPV18-M1H-V140-1/4
	E	Vacuum generator with ejector pulse	25	185865	CPV10-M1H-VI70-2GLS-M7
			114	185871	CPV14-M1H-VI95-2GLS-1/8
			264	185877	CPV18-M1H-VI140-2GLS-1/4
Function block					
	G	Valve kit for 5/3-way valve function, closed (in combination with valve slice C) for size 10 and 14	23	176055	CPV10-BS-5/3G-M7
			190	176057	CPV14-BS-5/3G-1/8
Separator plates					
	T	Separator plate, duct 1/11 closed	25	161369	CPV10-DZP
			–	162551	CPV14-DZP
			25	163282	CPV18-DZP
	S	Separator plate, duct 1/11, 3/5 closed	25	178678	CPV10-DZPR
			–	178680	CPV14-DZPR
			–	184543	CPV18-DZPR
Blanking plate					
	L	Blanking plate	25	161368	CPV10-RZP
				162550	CPV14-RZP
				163283	CPV18-RZP
Additional functions for valve positions					
	P	One-way flow control valve, 2x supply air	30	184140	CPV10-BS-2XGRZZ-M7
			54	184142	CPV14-BS-2XGRZZ-1/8
	Q	One-way flow control valve, 2x exhaust air	30	184141	CPV10-BS-2XGRAZ-M7
			54	184143	CPV14-BS-2XGRAZ-1/8
	V	One-way flow control valve for vacuum	30	185889	CPV10-BS-GRZ-V-M7
			–	185891	CPV14-BS-GRZ-V-1/8

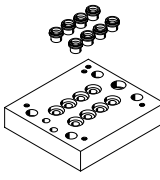

ATEX accessories

Ordering data		Code	Designation	Product weight [g]	Part no.	Type
Pneumatic multiple connector plate						
	M	Pneumatic multiple connector plate, for wall/machine mounting, without side flange	2 valves	135	161969	CPV10-VI-P2-M7
			4 valves	164	161970	CPV10-VI-P4-M7
			6 valves	219	161971	CPV10-VI-P6-M7
			8 valves	272	163893	CPV10-VI-P8-M7
			2 valves	261	163894	CPV14-VI-P2-1/8
			4 valves	379	163895	CPV14-VI-P4-1/8
			6 valves	505	163896	CPV14-VI-P6-1/8
			8 valves	627	163897	CPV14-VI-P8-1/8
			2 valves	519	165292	CPV18-VI-P2-1/4
			4 valves	695	165293	CPV18-VI-P4-1/4
			6 valves	907	165294	CPV18-VI-P6-1/4
			8 valves	1116	165295	CPV18-VI-P8-1/4
	P	Pneumatic multiple connector plate, for wall/machine mounting, with side flange	2 valves	182	152420	CPV10-VI-P2-M7-B
			4 valves	228	152421	CPV10-VI-P4-M7-B
			6 valves	283	152422	CPV10-VI-P6-M7-B
			8 valves	336	152423	CPV10-VI-P8-M7-B
			2 valves	365	152424	CPV14-VI-P2-1/8-B
			4 valves	483	152425	CPV14-VI-P4-1/8-B
			6 valves	609	152426	CPV14-VI-P6-1/8-B
			8 valves	731	152427	CPV14-VI-P8-1/8-B
			2 valves	659	175632	CPV18-VI-P2-1/4-B
			4 valves	832	175634	CPV18-VI-P4-1/4-B
			6 valves	1047	175636	CPV18-VI-P6-1/4-B
			8 valves	1256	175638	CPV18-VI-P8-1/4-B
	GQC	Pneumatic multiple connector plate with sealing ring, for control cabinet assembly, with supply ports	2 valves	250	538807	CPV10-VI-P2-M7-C
			4 valves	320	538808	CPV10-VI-P4-M7-C
			6 valves	390	538809	CPV10-VI-P6-M7-C
			8 valves	460	538810	CPV10-VI-P8-M7-C
			2 valves	500	539498	CPV14-VI-P2-1/8-C
			4 valves	650	539499	CPV14-VI-P4-1/8-C
			6 valves	800	539500	CPV14-VI-P6-1/8-C
			8 valves	920	539501	CPV14-VI-P8-1/8-C
GQD	Pneumatic multiple connector plate with sealing ring, for control cabinet assembly, without supply ports	2 valves	80	538811	CPV10-VI-P2-M7-D	
		4 valves	150	538812	CPV10-VI-P4-M7-D	
		6 valves	220	538813	CPV10-VI-P6-M7-D	
		8 valves	290	538814	CPV10-VI-P8-M7-D	
		2 valves	350	539502	CPV14-VI-P2-1/8-D	
		4 valves	550	539503	CPV14-VI-P4-1/8-D	
		6 valves	400	539504	CPV14-VI-P6-1/8-D	
		8 valves	650	539505	CPV14-VI-P8-1/8-D	
GQE	Pneumatic multiple connector plate with sealing ring, for control cabinet assembly, with all ports	2 valves	300	566709	CPV10-VI-P2-1/8-C	
		4 valves	370	566710	CPV10-VI-P4-1/8-C	
		6 valves	440	566711	CPV10-VI-P6-1/8-C	
		8 valves	510	566712	CPV10-VI-P8-1/8-C	

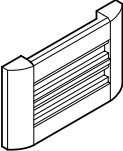
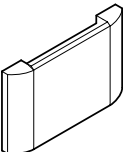
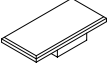
ATEX accessories

Ordering data		Code	Designation	Product weight [g]	Part no.	Type
Inscription label holders						
	Z	Holder for inscription labels	32	162560	CPV10-VI-BZ-T-2	
			33	162561	CPV10-VI-BZ-T-3	
			34	162562	CPV10-VI-BZ-T-4	
			35	162563	CPV10-VI-BZ-T-5	
			36	162564	CPV10-VI-BZ-T-6	
			37	162565	CPV10-VI-BZ-T-7	
			38	162566	CPV10-VI-BZ-T-8	
			8	162567	CPV14-VI-BZ-T-2	
			9.5	162568	CPV14-VI-BZ-T-3	
			11	162569	CPV14-VI-BZ-T-4	
			12.5	162570	CPV14-VI-BZ-T-5	
			14	162571	CPV14-VI-BZ-T-6	
			15.5	162572	CPV14-VI-BZ-T-7	
			17	162573	CPV14-VI-BZ-T-8	
			9	163293	CPV18-VI-BZ-T-2	
			10.5	163294	CPV18-VI-BZ-T-3	
			12	163295	CPV18-VI-BZ-T-4	
			13.5	163296	CPV18-VI-BZ-T-5	
			16	163297	CPV18-VI-BZ-T-6	
			17.5	163298	CPV18-VI-BZ-T-7	
29	163299	CPV18-VI-BZ-T-8				
	T	Holder for inscription labels, transparent	11	194066	CPV10-VI-ST-T-2	
			14	194067	CPV10-VI-ST-T-3	
			17	194068	CPV10-VI-ST-T-4	
			20	194069	CPV10-VI-ST-T-5	
			23	194070	CPV10-VI-ST-T-6	
			24	194071	CPV10-VI-ST-T-7	
			29	194072	CPV10-VI-ST-T-8	
			-	194073	CPV14-VI-ST-T-2	
			18	194074	CPV14-VI-ST-T-3	
			22	194075	CPV14-VI-ST-T-4	
			25	194076	CPV14-VI-ST-T-5	
			53	194077	CPV14-VI-ST-T-6	
			59	194078	CPV14-VI-ST-T-7	
			63	194079	CPV14-VI-ST-T-8	
			17	194080	CPV18-VI-ST-T-2	
			23	194081	CPV18-VI-ST-T-3	
			29	194082	CPV18-VI-ST-T-4	
			35	194083	CPV18-VI-ST-T-5	
			41	194084	CPV18-VI-ST-T-6	
			47	194085	CPV18-VI-ST-T-7	
53	194086	CPV18-VI-ST-T-8				
Inscription labels						
	-	6x10 mm in frame, 64 pieces	-	18576	IBS 6x10	
		9x20 mm in frames, 20 pieces (CPV18 only)	-	18182	IBS 9x20	

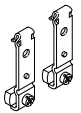
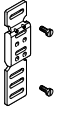
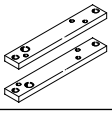
ATEX accessories

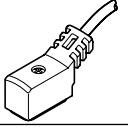
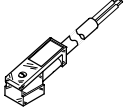

Ordering data		Code	Designation	Product weight [g]	Part no.	Type
Mounting						
	H	Mounting for H-rail		15.8	162556	CPV10/14-VI-BG-NRH-35
				50	163291	CPV18-VI-BG-NRH-35
	W	Attachment for wall mounting	For CPV18	200	163292	CPV18-VI-BG-RW
	U		For CPV10/14	118	189541	CPV10/14-VI-BG-RWL-B
	X	Mounting for individual connection and ET200X (included in the scope of delivery)		216	165801	CPV10-VI-BG-ET200X
				326	165803	CPV14-VI-BG-ET200X
Manual override						
	-	Locking clip (for manual override), non-detachable		1.5	526203	CPV10/14-HS
				3	526204	CPV18-HS
	V	Locking clip (cover for manual override), non-detachable		0.15	530055	CPV10/14-HV
				0.53	530056	CPV18-HV
Connecting cable for individual connection, electrical						
	D	Angled socket, plug pattern ZC, self-tapping screw, for CPV10/14	2.5 m	50	8047676	NEBV-Z3WA2L-R-E-2.5-N-LE2-S1
	E		5 m	90	8047677	NEBV-Z3WA2L-R-E-5-N-LE2-S1
	F		10 m	170	8047675	NEBV-Z3WA2L-R-E-10-N-LE2-S1
Plug socket with cable for individual connection, electrical						
	D	For CPV18	2.5 m	200	174844	KMEB-2-24-2.5-LED
	E		5 m	400	174845	KMEB-2-24-5-LED

 **Note**

Connecting cables are pre-assembled. They include a protective circuit and an LED for indicating the operating status.

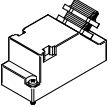
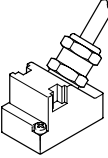

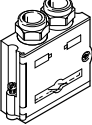

ATEX accessories

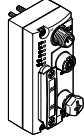
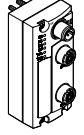
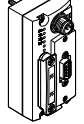
Ordering data		Code	Designation	Product weight [g]		Part no.	Type	
Multi-pin cable								
	Y		Plug socket (Sub-D plug can be crimped), for assembly by the user	9-pin	73	18708	SD-SUB-D-BU9	
				25-pin	75	18709	SD-SUB-D-BU25	
	R		Connecting cable, IP65, polyvinyl chloride	9-pin	5 m	425	18698	KMP3-9P-08-5
				25-pin		672	18624	KMP3-25P-16-5
				9-pin	10 m	814	18579	KMP3-9P-08-10
				25-pin		1303	18625	KMP3-25P-16-10
	-		Connecting cable, IP65, polyurethane (suitable for energy chains)	9-pin	5 m	378	193014	KMP4-9P-5-PUR
				25-pin		702	193018	KMP4-25P-5-PUR
	-		Connecting cable, IP65, polyurethane (suitable for energy chains)	9-pin	10 m	723	193015	KMP4-9P-10-PUR
				25-pin		1617	193019	KMP4-25P-10-PUR
	-		Connecting cable, IP65, polyvinyl chloride (suitable for energy chains)	9-pin	5 m	413	193012	KMP4-9P-5-PVC
				25-pin		854	193016	KMP4-25P-5-PVC
9-pin				10 m	791	193013	KMP4-9P-10-PVC	
25-pin					1657	193017	KMP4-25P-10-PVC	

Ordering data		Code	Designation	Product weight [g]	Part no.	Type
Fieldbus interface for Fieldbus Direct						
	GE		Sub-D plug, IP65, 9-pin for PROFIBUS DP	60	532216	FBS-SUB-9-GS-DP-B
	GF		Bus connection 2x M12 adapter (B-coded, ReverseKey) for PROFIBUS DP	80	533118	FBA-2-M12-5POL-RK

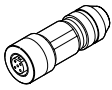
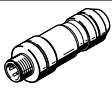
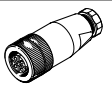
Ordering data		Designation	Certification	Part no.	Type
Bus node					
	EP bus node		RCM	8107591	CTEU-EP-EX1C
	PN bus node			8107589	CTEU-PN-EX1C
	PB bus node			8107588	CTEU-PB-EX1C

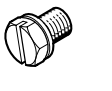
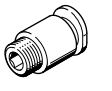
ATEX accessories

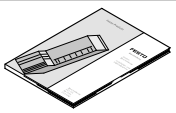
Ordering data		Code	Designation	Product weight [g]	Part no.	Type
Fieldbus interface for Fieldbus Direct						
	–	Socket M12x1, 5-pin, straight, for assembly by the user of a connecting cable for FBA-2-M12-5POL-RK		–	1067905	NECU-M-B12G5-C2-PB
	–	Plug M12x1, 5-pin, straight, for assembly by the user of a connecting cable for FBA-2-M12-5POL-RK		–	1066354	NECU-M-S-B12G5-C2-PB
Operating voltage connection for Fieldbus Direct						
	Straight socket	M12, 4-pin, PG7, IP67	13	18494	SIE-GD	
		M12, 4-pin, PG9, IP67	29	18495	FBSD-GD-9	
	Angled plug socket	M12, 4-pin, IP67	13	12956	SIE-WD-TR	
		M12, 4-pin, PG9, IP67	30	18525	FBSD-WD-9	
Blanking plug						
	Blanking plug		1	3843	B-M5	
			2	174309	B-M7	
			7	3568	B-1/8	
			15	3569	B-1/4	
			23	3570	B-3/8	
			43	3571	B-1/2	
Push-in fitting						
	Push-in fitting		12	186109	QS-G1/8-8-I	
			20	186112	QS-G1/4-10-I	
			34	186114	QS-G3/8-12-I	
			4.4	153317	QSM-M5-6-I	
			6.4	153321	QSM-M7-6-I	
Silencer						
	Silencer		1.5	1205858	AMTE-M-LH-M5	
			43	1205863	AMTE-M-LH-G12	
			13	1205861	AMTE-M-LH-G14	
			7.5	1205860	AMTE-M-LH-G18	
			26	1205862	AMTE-M-LH-G38	
			1.2	161418	UC-M7	
User documentation						
	Description CPV pneumatics	German	–	165100	P.BE-CPV-DE	
		English		165200	P.BE-CPV-EN	
		French		165130	P.BE-CPV-FR	
		Italian		165160	P.BE-CPV-IT	
		Spanish		165230	P.BE-CPV-ES	

Accessories NEC500

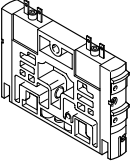
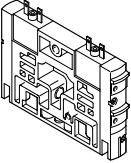
Ordering data					
	Code	Valve function	Product weight [g]	Part no.	Type
Individual sub-base valve, size 10/14/18					
	M	5/2-way valve, single solenoid, piston spool valve	70	161414	CPV10-M1H-5LS-M7
			120	161360	CPV14-M1H-5LS-1/8
			260	163190	CPV18-M1H-5LS-1/4
	F	5/2-way valve, single solenoid, fast switching, piston spool valve	70	187439	CPV10-M11H-5LS-M7
			120	161415	CPV10-M1H-5JS-M7
			260	163191	CPV18-M1H-5JS-1/4
	J	5/2-way valve, double solenoid, piston spool valve	70	161415	CPV10-M1H-5JS-M7
			120	161361	CPV14-M1H-5JS-1/8
			260	163191	CPV18-M1H-5JS-1/4
	N	2x 3/2-way valve, normally open, piston spool valve	70	161417	CPV10-M1H-2x3-OLS-M7
			120	161363	CPV14-M1H-2x3-OLS-1/8
			260	163188	CPV18-M1H-2x3-OLS-1/4
	C	2x 3/2-way valve, normally closed, piston spool valve	70	161416	CPV10-M1H-2x3-GLS-M7
			120	161362	CPV14-M1H-2x3-GLS-1/8
			260	163189	CPV18-M1H-2x3-GLS-1/4
	CY	2x 3/2-way valve, normally closed, integrated back pressure protection, piston spool valve	70	553260	CPV10-M1H-2x3-GLS-Y-M7
	H	2x 3/2-way valve, 1x normally open, 1x normally closed, piston spool valve	70	176064	CPV10-M1H-30LS-3GLS-M7
			120	176067	CPV14-M1H-30LS-3GLS-1/8
			260	176070	CPV18-M1H-30LS-3GLS-1/4
	G	5/3-way valve, mid-position closed, piston spool valve	260	176061	CPV18-M1H-5/3GS-1/4
D	2x 2/2-way valve, normally closed, piston spool valve	70	185880	CPV10-M1H-2x2-GLS-M7	
		120	185883	CPV14-M1H-2x2-GLS-1/8	
		260	185886	CPV18-M1H-2x2-GLS-1/4	
I	2x 2/2-way valve, 1x normally open, 1x normally closed, piston spool valve	70	187843	CPV10-M1H-20LS-2GLS-M7	
		120	187846	CPV14-M1H-20LS-2GLS-1/8	
		260	187849	CPV18-M1H-20LS-2GLS-1/4	
Individual sub-base valve with duct separation 1, 11 sizes 10/14					
	MK	5/2-way valve (with duct separation 1, 11), single solenoid, piston spool valve	70	553256	CPV10-M1H-5LS-K-M7
			120	553258	CPV14-M1H-5LS-K-1/8
	JK	5/2-way valve (with duct separation 1, 11), double solenoid, piston spool valve	70	559644	CPV10-M1H-5JS-K-M7
			120	559651	CPV14-M1H-5JS-K-1/8
	NK	2x 3/2-way valve (with duct separation 1, 11), normally open, piston spool valve	70	559641	CPV10-M1H-2x3-OLS-K-M7
			120	559648	CPV14-M1H-2x3-OLS-K-1/8
	CK	2x 3/2-way valve (with duct separation 1, 11) normally closed, piston spool valve	70	553257	CPV10-M1H-2x3-GLS-K-M7
			120	553259	CPV14-M1H-2x3-GLS-K-1/8
	HK	2x 3/2-way valve (with duct separation 1, 11), 1x normally open, 1x normally closed, piston spool valve	70	559642	CPV10-M1H-30LS-3GLS-K-M7
			120	559649	CPV14-M1H-30LS-3GLS-K-1/8
	DK	2x 2/2-way valve (with duct separation 1, 11), normally closed, piston spool valve	70	559645	CPV10-M1H-2x2-GLS-K-M7
			120	559652	CPV14-M1H-2x2-GLS-K-1/8
	IK	2x 2/2-way valve (with duct separation 1, 11), 1x normally open, 1x normally closed, piston spool valve	70	559646	CPV10-M1H-20LS-2GLS-K-M7
			120	559653	CPV14-M1H-20LS-2GLS-K-1/8

Accessories NEC500

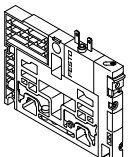
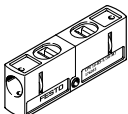
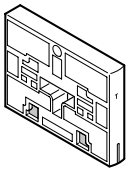
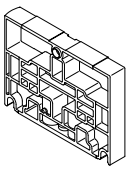
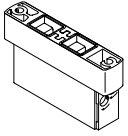
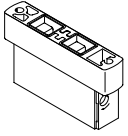
Ordering data					
	Code	Designation	Product weight [g]	Part no.	Type
Vacuum generator					
	A	Vacuum generator	25	185862	CPV10-M1H-V70-M7
			98	185868	CPV14-M1H-V95-1/8
			227	185874	CPV18-M1H-V140-1/4
	E	Vacuum generator with ejector pulse	25	185865	CPV10-M1H-VI70-2GLS-M7
			114	185871	CPV14-M1H-VI95-2GLS-1/8
			264	185877	CPV18-M1H-VI140-2GLS-1/4
Function block					
	G	Valve kit for 5/3-way valve function, closed (in combination with valve slice C) for size 10 and 14	23	176055	CPV10-BS-5/3G-M7
			190	176057	CPV14-BS-5/3G-1/8
Separator plates					
	T	Separator plate, duct 1/11 closed	25	161369	CPV10-DZP
			–	162551	CPV14-DZP
			25	163282	CPV18-DZP
	S	Separator plate, duct 1/11, 3/5 closed	25	178678	CPV10-DZPR
				178680	CPV14-DZPR
				184543	CPV18-DZPR
Blanking plate					
	L	Blanking plate	25	161368	CPV10-RZP
				162550	CPV14-RZP
				163283	CPV18-RZP
Additional functions for valve positions					
	P	One-way flow control valve, 2x supply air	30	184140	CPV10-BS-2XGRZZ-M7
			54	184142	CPV14-BS-2XGRZZ-1/8
	Q	One-way flow control valve, 2x exhaust air	30	184141	CPV10-BS-2XGRAZ-M7
			54	184143	CPV14-BS-2XGRAZ-1/8
	V	One-way flow control valve for vacuum	30	185889	CPV10-BS-GRZ-V-M7
			–	185891	CPV14-BS-GRZ-V-1/8

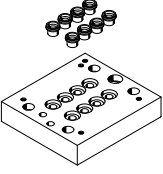

Accessories NEC500

Ordering data		Code	Designation	Product weight [g]	Part no.	Type
Pneumatic multiple connector plate						
	M	Pneumatic multiple connector plate, for wall/machine mounting, without side flange	2 valves	135	161969	CPV10-VI-P2-M7
			4 valves	164	161970	CPV10-VI-P4-M7
			6 valves	219	161971	CPV10-VI-P6-M7
			8 valves	272	163893	CPV10-VI-P8-M7
			2 valves	261	163894	CPV14-VI-P2-1/8
			4 valves	379	163895	CPV14-VI-P4-1/8
			6 valves	505	163896	CPV14-VI-P6-1/8
			8 valves	627	163897	CPV14-VI-P8-1/8
			2 valves	519	165292	CPV18-VI-P2-1/4
			4 valves	695	165293	CPV18-VI-P4-1/4
			6 valves	907	165294	CPV18-VI-P6-1/4
			8 valves	1116	165295	CPV18-VI-P8-1/4
	P	Pneumatic multiple connector plate, for wall/machine mounting, with side flange	2 valves	182	152420	CPV10-VI-P2-M7-B
			4 valves	228	152421	CPV10-VI-P4-M7-B
			6 valves	283	152422	CPV10-VI-P6-M7-B
			8 valves	336	152423	CPV10-VI-P8-M7-B
			2 valves	365	152424	CPV14-VI-P2-1/8-B
			4 valves	483	152425	CPV14-VI-P4-1/8-B
			6 valves	609	152426	CPV14-VI-P6-1/8-B
			8 valves	731	152427	CPV14-VI-P8-1/8-B
			2 valves	659	175632	CPV18-VI-P2-1/4-B
			4 valves	832	175634	CPV18-VI-P4-1/4-B
			6 valves	1047	175636	CPV18-VI-P6-1/4-B
			8 valves	1256	175638	CPV18-VI-P8-1/4-B
	GQC	Pneumatic multiple connector plate with sealing ring, for control cabinet assembly, with supply ports	2 valves	250	538807	CPV10-VI-P2-M7-C
			4 valves	320	538808	CPV10-VI-P4-M7-C
			6 valves	390	538809	CPV10-VI-P6-M7-C
			8 valves	460	538810	CPV10-VI-P8-M7-C
			2 valves	500	539498	CPV14-VI-P2-1/8-C
			4 valves	650	539499	CPV14-VI-P4-1/8-C
			6 valves	800	539500	CPV14-VI-P6-1/8-C
			8 valves	920	539501	CPV14-VI-P8-1/8-C
	GQD	Pneumatic multiple connector plate with sealing ring, for control cabinet assembly, without supply ports	2 valves	80	538811	CPV10-VI-P2-M7-D
			4 valves	150	538812	CPV10-VI-P4-M7-D
			6 valves	220	538813	CPV10-VI-P6-M7-D
			8 valves	290	538814	CPV10-VI-P8-M7-D
			2 valves	350	539502	CPV14-VI-P2-1/8-D
			4 valves	550	539503	CPV14-VI-P4-1/8-D
			6 valves	400	539504	CPV14-VI-P6-1/8-D
			8 valves	650	539505	CPV14-VI-P8-1/8-D
GQE	Pneumatic multiple connector plate with sealing ring, for control cabinet assembly, with all ports	2 valves	300	566709	CPV10-VI-P2-1/8-C	
		4 valves	370	566710	CPV10-VI-P4-1/8-C	
		6 valves	440	566711	CPV10-VI-P6-1/8-C	
		8 valves	510	566712	CPV10-VI-P8-1/8-C	

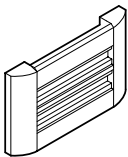
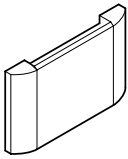
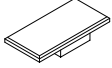
Accessories NEC500

Ordering data		Code	Designation	Product weight [g]	Part no.	Type
Inscription label holders						
	Z	Holder for inscription labels	32	162560	CPV10-VI-BZ-T-2	
			33	162561	CPV10-VI-BZ-T-3	
			34	162562	CPV10-VI-BZ-T-4	
			35	162563	CPV10-VI-BZ-T-5	
			36	162564	CPV10-VI-BZ-T-6	
			37	162565	CPV10-VI-BZ-T-7	
			38	162566	CPV10-VI-BZ-T-8	
			8	162567	CPV14-VI-BZ-T-2	
			9.5	162568	CPV14-VI-BZ-T-3	
			11	162569	CPV14-VI-BZ-T-4	
			12.5	162570	CPV14-VI-BZ-T-5	
			14	162571	CPV14-VI-BZ-T-6	
			15.5	162572	CPV14-VI-BZ-T-7	
			17	162573	CPV14-VI-BZ-T-8	
			9	163293	CPV18-VI-BZ-T-2	
			10.5	163294	CPV18-VI-BZ-T-3	
			12	163295	CPV18-VI-BZ-T-4	
			13.5	163296	CPV18-VI-BZ-T-5	
			16	163297	CPV18-VI-BZ-T-6	
17.5	163298	CPV18-VI-BZ-T-7				
29	163299	CPV18-VI-BZ-T-8				
	T	Holder for inscription labels, transparent	11	194066	CPV10-VI-ST-T-2	
			14	194067	CPV10-VI-ST-T-3	
			17	194068	CPV10-VI-ST-T-4	
			20	194069	CPV10-VI-ST-T-5	
			23	194070	CPV10-VI-ST-T-6	
			24	194071	CPV10-VI-ST-T-7	
			29	194072	CPV10-VI-ST-T-8	
			-	194073	CPV14-VI-ST-T-2	
			18	194074	CPV14-VI-ST-T-3	
			22	194075	CPV14-VI-ST-T-4	
			25	194076	CPV14-VI-ST-T-5	
			53	194077	CPV14-VI-ST-T-6	
			59	194078	CPV14-VI-ST-T-7	
			63	194079	CPV14-VI-ST-T-8	
			17	194080	CPV18-VI-ST-T-2	
			23	194081	CPV18-VI-ST-T-3	
			29	194082	CPV18-VI-ST-T-4	
			35	194083	CPV18-VI-ST-T-5	
			41	194084	CPV18-VI-ST-T-6	
47	194085	CPV18-VI-ST-T-7				
53	194086	CPV18-VI-ST-T-8				
Inscription labels						
	-	6x10 mm in frame, 64 pieces	-	18576	IBS 6x10	
		9x20 mm in frames, 20 pieces (CPV18 only)	-	18182	IBS 9x20	

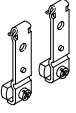
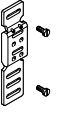
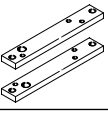
Accessories NEC500

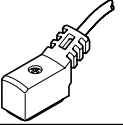
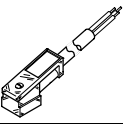
Ordering data		Code	Designation	Product weight [g]	Part no.	Type	
Mounting							
	H	Mounting for H-rail		15.8	162556	CPV10/14-VI-BG-NRH-35	
				50	163291	CPV18-VI-BG-NRH-35	
	W	Attachment for wall mounting	For CPV18	200	163292	CPV18-VI-BG-RW	
	U		For CPV10/14	118	189541	CPV10/14-VI-BG-RWL-B	
	X	Mounting for individual connection and ET200X (included in the scope of delivery)		216	165801	CPV10-VI-BG-ET200X	
				326	165803	CPV14-VI-BG-ET200X	
Manual override							
	-	Locking clip (for manual override), non-detachable		1.5	526203	CPV10/14-HS	
				3	526204	CPV18-HS	
	V	Locking clip (cover for manual override), non-detachable		0.15	530055	CPV10/14-HV	
				0.53	530056	CPV18-HV	
Connecting cable for individual connection, electrical							
	D	Angled socket, plug pattern ZC, self-tapping screw, for CPV10/14		2.5 m	50	8047676	NEBV-Z3WA2L-R-E-2.5-N-LE2-S1
	E			5 m	90	8047677	NEBV-Z3WA2L-R-E-5-N-LE2-S1
	F			10 m	170	8047675	NEBV-Z3WA2L-R-E-10-N-LE2-S1
Plug socket with cable for individual connection, electrical							
	D	For CPV18		2.5 m	200	174844	KMEB-2-24-2.5-LED
	E			5 m	400	174845	KMEB-2-24-5-LED



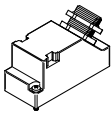
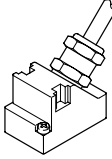

 **Note**

Connecting cables are pre-assembled. They include a protective circuit and an LED for indicating the operating status.

Accessories NEC500

Ordering data		Code	Designation	Product weight [g]		Part no.	Type	
Multi-pin cable								
	Y	Plug socket (Sub-D plug can be crimped), for assembly by the user	9-pin		73	18708	SD-SUB-D-BU9	
			25-pin		75	18709	SD-SUB-D-BU25	
	R	Connecting cable, IP65, polyvinyl chloride	9-pin	5 m	425	18698	KMP3-9P-08-5	
			25-pin		672	18624	KMP3-25P-16-5	
			S	9-pin	10 m	814	18579	KMP3-9P-08-10
				25-pin		1303	18625	KMP3-25P-16-10
	-	Connecting cable, IP65, polyurethane (suitable for energy chains)	9-pin	5 m	378	193014	KMP4-9P-5-PUR	
			25-pin		702	193018	KMP4-25P-5-PUR	
	-		9-pin	10 m	723	193015	KMP4-9P-10-PUR	
			25-pin		1617	193019	KMP4-25P-10-PUR	
	-	Connecting cable, IP65, polyvinyl chloride (suitable for energy chains)	9-pin	5 m	413	193012	KMP4-9P-5-PVC	
			25-pin		854	193016	KMP4-25P-5-PVC	
9-pin			10 m	791	193013	KMP4-9P-10-PVC		
25-pin				1657	193017	KMP4-25P-10-PVC		

Accessories NEC500

Ordering data		Code	Designation	Product weight [g]	Part no.	Type
Blanking plug						
	Blanking plug			1	3843	B-M5
				2	174309	B-M7
				7	3568	B-1/8
				15	3569	B-1/4
				23	3570	B-3/8
				43	3571	B-1/2
Push-in fitting						
	Push-in fitting			12	186109	QS-G1/8-8-I
				20	186112	QS-G1/4-10-I
				34	186114	QS-G3/8-12-I
				4.4	153317	QSM-M5-6-I
				6.4	153321	QSM-M7-6-I
Silencer						
	Silencer			1.5	1205858	AMTE-M-LH-M5
				43	1205863	AMTE-M-LH-G12
				13	1205861	AMTE-M-LH-G14
				7.5	1205860	AMTE-M-LH-G18
				26	1205862	AMTE-M-LH-G38
				1.2	161418	UC-M7
User documentation						
	Description CPV pneumatics	German	-		165100	P.BE-CPV-DE
		English			165200	P.BE-CPV-EN
		French			165130	P.BE-CPV-FR
		Italian			165160	P.BE-CPV-IT
		Spanish			165230	P.BE-CPV-ES