

Valve manifold assembly CPV10-EX-VI, Compact Performance

FESTO

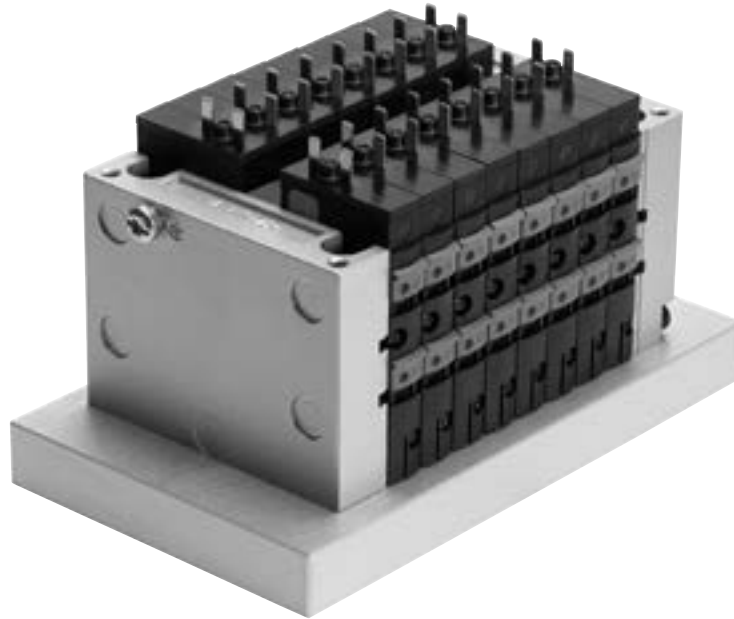

Key features



Innovative

- Cubic design for exceptional performance and low weight
- Sturdy
- Optimised for installation in a control cabinet
- Suitable for pilot control of process valves
- High flow rate with extremely compact design

Versatile

- Up to sixteen 2/2- or 3/2-way valves per valve manifold assembly, in one slice thanks to dual function
- Flexible and cost-effective connection of two to eight valve slices
- Highly flexible thanks to:
 - various pneumatic functions (valve variants)
 - different pressure ranges
- Separator plates for creating pressure zones
- Blanking plates for later extensions

Reliable

- Manual overrides for valves
- Protection class to IP65 in the control cabinet
- Intrinsically safe valve manifold assembly to ATEX category 2 (zone 1)
- Extremely robust thanks to the metal valve design
- Long service life

Easy to assemble

- Ready-to-install and tested unit
- Reduced costs for selection, ordering, assembly and commissioning
- Secure wall mounting or H-rail mounting
- Pneumatic multiple connector plate – quick replacement of the valve block with the tubing in place
- Valve assembly optimised for control cabinets

Key features

Main features

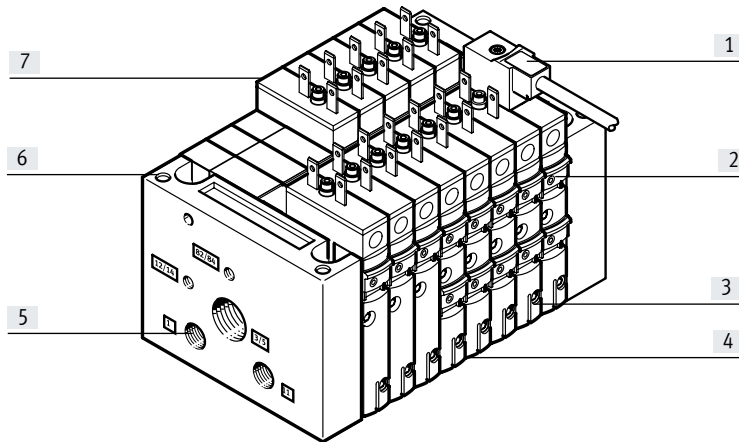

- [1] Inscription labels
- [2] Safe operation:
Manual override, non-detenting, detenting or blocked
- [3] Comprehensive range of valve functions, pressure zone formation, blanking plates
- [4] Width
– 10 mm
- [5] Robust metal thread or pre-assembled QS connectors
- [6] Quick to mount:
– directly using screws
– on an H-rail
– via the pneumatic multiple connector plate
- [7] Simple electrical connections:
– individual connection

Equipment options

Valve functions

- 5/2-way valve, single solenoid
- 5/2-way valve, double solenoid
- 2x 3/2-way valve, normally open
- 2x 3/2-way valve, normally closed
- 2x 3/2-way valve, 1x normally open, 1x closed
- 2x 3/2-way valve, normally closed
- 2x 3/2-way valve, normally closed, with integrated back pressure protection
- 5/3-way valve¹⁾
- 2x 2/2-way valve, normally closed
- 2x 2/2-way valve, 1x normally open, 1x closed

Special features

Individual connection

- 2 ... 8 valve positions, max. 16 solenoid coils

Intrinsically safe

The valve manifold assembly CPV10 EX-VI has an intrinsically safe design for applications in potentially explosive areas to ATEX category 2 (zone 1)

Pneumatic multiple connector plate

Pneumatic multiple connector plate for wall through-feed enables installation in a control cabinet; IP65 sealing

Operation

Control only with intrinsically safe circuit with individual valve connection

1) Via function block, not in combination with pneumatic multiple connector plate

Key features

Electrical connections

Individual connection in explosion-proof design

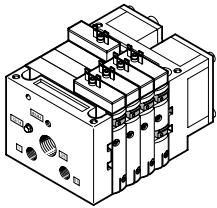

The CPV10-EX-VI is a valve manifold assembly with an intrinsically safe design for use in zone 1 potentially explosive areas (ATEX category 2 G).
 Definition of intrinsically safe:
 A system comprising electrical output and solenoid coils is designed in such a way that no spark or thermal effect

can cause ignition in an explosive atmosphere. Each solenoid coil must be connected to an intrinsically safe circuit that complies with ignition protection type ia IIC or ib IIC.

2 to 16 solenoid coils (divided between two to eight valve slices, including odd numbers) can be selected with individual connection.

Range of application

Explosive gases or dusts are present in many applications. In this case, devices with enhanced explosion protection requirements (category 2 corresponding to zone 1) are needed. Sparking, as can occur for example when switching off a solenoid coil, must be reliably prevented. There are different ways of doing this. Solenoid coils in this area are often of "intrinsically safe" design. Here, intrinsically safe means that no spark or thermal effect can occur that would cause ignition of the explosive atmosphere.

The valve manifold series CPV10 is already approved for explosion-protected areas to ATEX. This approval is for category 3. This corresponds to zone 2, in which an explosive atmosphere does not normally occur, or occurs only briefly.
 The valve manifold assembly CPV10-EX-VI extends this function to higher ATEX requirements:

- Approval for category 2, zone 1.

The intrinsically safe valve manifold assembly has an integrated protective circuit which prevents ignition of gas, mist or vapour. Circuits for intrinsically safe solenoid coils are furthermore designed in such a way that only low voltages and energies can occur. The valve manifold assembly is therefore equipped with individually connected valves.
 The CPV10-EX-VI must only be operated in suitable intrinsically safe circuits.

In process technology, valves for piloting process valves are frequently installed in the control cabinet. The pneumatic multiple connector plate for control cabinets CPV10-VI-...-M7-C or -D simplifies installation of the pneumatic connections. Instead of several different bulkhead fittings with tubing, the installation can be carried out using just a single through-hole in the wall. Protection class IP65 is achieved via a sealing ring suitable for closed control cabinet assembly. With the pneumatic multiple connector plate the valve manifold assembly CPV10-EX-VI can be operated in suitable control cabinets in zones 1 and 21 (ATEX category 2 GD).

Ordering data – Product options

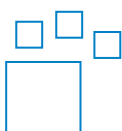



Configurable product
 This product and all its product options can be ordered using the configurator.

The configurator can be found at
 → www.festo.com/catalogue/...
 Enter the part number or the type.

Part no.	Type
539506	CPV10-EX-VI

Key features – ATEX

Certifications	
 	In accordance with EU Directive 94/9/EC (ATEX Directive) Use in potentially explosive atmospheres II 2G Ex ib IIC T4 Gb II 2D Ex ib IIIC T100°C Db -5°C ≤ Ta ≤ 50°C

CPV use in Zone 1/2

Intrinsically safe valve manifold assembly in a control cabinet. Actuation via multi-core connecting cable.

CPV use in Zone 1/2

Intrinsically safe valve manifold assembly (pneumatic multiple connector plate) and remote I/O in a control cabinet.

What does ATEX mean?

Explosive atmospheres are a constant hazard in the chemical and petrochemical industries because of the processing techniques used. These explosive atmospheres are caused by escaping gas, vapour and mist, for example.

Explosive atmospheres can also occur in mills, silos and sugar and feed processing plants because of the dust/oxygen mixtures there. Electrical equipment in potentially explosive areas is therefore subject to a special directive,

the ATEX Directive (ATEX 95a). This directive was also extended to non-electrical equipment on 1 July 2003.

What does ATEX 95a stand for and what does it mean?

- ATEX is an acronym of the French expression "Atmosphère explosible"
- ATEX 95a refers to Article 95a of the corresponding EC treaty
- ATEX 95a is merely the working title
- ATEX 95a is backed by **Directive 94/9/EC:**
- **Directive 94/9/EC** stipulates the minimum safety requirements for equipment and protective systems to be operated in explosive atmospheres.
- It applies to all EU member states.
- It relates to both electrical and non-electrical equipment.

What are the main new elements of Directive 94/9/EC?

- The scope of application now also covers non-electrical equipment such as cylinders, pneumatic valves, service unit components and accessories.
- The devices are approved for specific categories. The categories are allocated to zones in which the devices can be used.
- Each piece of equipment must be supplied with operating instructions and a conformity declaration.
- The manufacturer's quality system must comply with specifications that go beyond ISO 9001.
- The new devices are identified by explosion protection and CE markings.
- Dust explosion protection now also falls within the scope of this directive.
- Basic safety requirements are specified.
- It applies both to mining and all other potentially explosive areas.
- It applies to complete protective systems.

Explosion protection classes					
Zone Gas	Zone Dust	Frequency	Equipment group	Equipment category	Area of application
			I	M	Mining
				M1	
				M2	
			II		All non-mining areas of application
0		Constant, frequent, long-term	II	1G	Gas, mist, vapour
	20		II	1D	Dust
1		Occasional	II	2G	Gas, mist, vapour
	21		II	2D	Dust
2		Seldom, short-term in the event of a fault	II	3G	Gas, mist, vapour
	22		II	3D	Dust

Key features

CPV – The benefits at a glance

The valve assembly CPV has a unique design. It allows a flexible mix of pneumatic performance, electrical connection technologies and a variety of installation types. In particular, the pneumatic multiple connector plate enables especially space-saving installation in control cabinets. The valve manifold assembly can often be installed directly in the previously unused wall area of the control cabinet. There is no need to connect up the valves inside the cabinet. All tubes can be connected on the outside. Instead of individual drilled holes, the

pneumatic multiple connector plate needs just one rectangular through-hole. The generously sized flow ducts and powerful flat plate silencers ensure high flow rates. All valves are provided as valve slices. They have a compact and flow-optimised design. With two functions per valve slice (e.g. 2x 3/2-way valves), double the component density can be achieved. This saves space and reduces costs. The cubic design permits exceptional performance with a comparatively low weight. These advantages become

clear when the valve manifold assembly is moved along on a drive. Despite it being compact, it is also very sturdy. The connecting threads and mounting attachments are metal. The manual override for the valves can be adapted for different operating situations. If, for example, a detenting manual override is required for set-up, this can later be easily changed again so that inadvertent actuation during operation is prevented.

The design principle

Each side of the cubic design has its own specific function. Thus, for example, the electrical connection is mounted on the top.

The different possible combinations allow the best possible solution for the task in hand.

- Pneumatic supply connections on the left, right or underneath
- Pneumatic working ports and function blocks (vertical stacking)
- Manual operation from the front
- Electrical connection surface on top
- Mounting surface on rear, or at the front via pneumatic multiple connector plate

Peripherals overview

Overview – Valve manifold assembly CPV

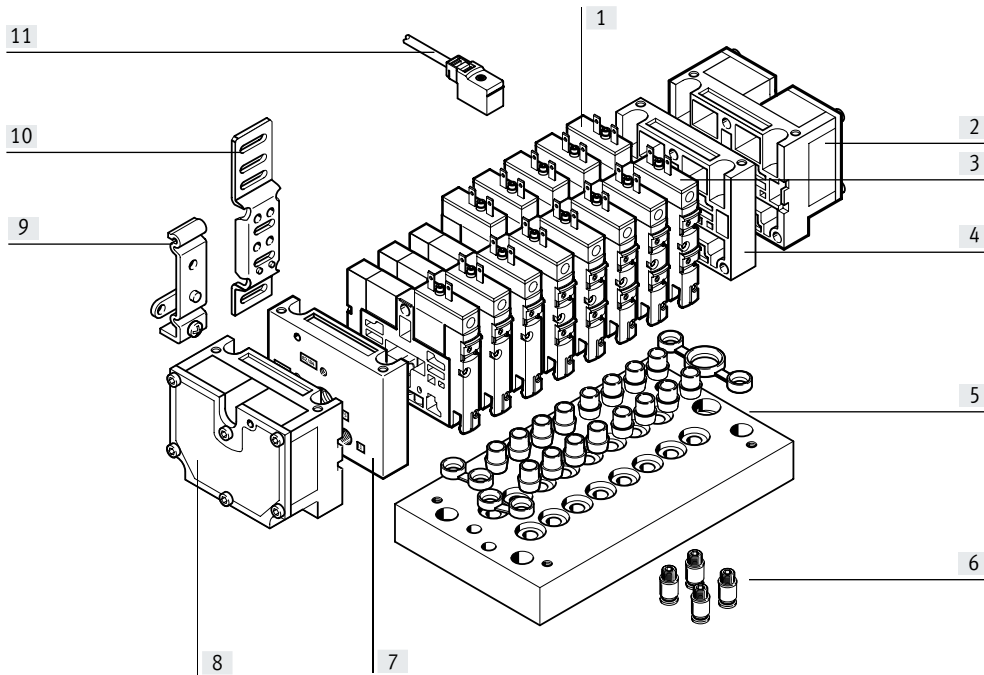

- | | | | |
|---|--|---|-----------------------------|
| [1] Basic electrical unit (individual connection) | [4] Right-hand end plate (threaded connections not in combination with pneumatic multiple connector plate) | [6] Push-in fittings | [9] H-rail mounting |
| [2] Right-hand end plate with flat plate silencer | [5] Pneumatic multiple connector plate | [7] Left-hand end plate (threaded connections not in combination with pneumatic multiple connector plate) | [10] Wall mounting |
| [3] Valve slice | [8] Left-hand end plate with flat plate silencer | | [11] Plug socket with cable |

Key features – Pneumatic components



Valves

Valves CPV are implemented as valves with integrated sub-base, i.e. in addition to the valve function they also include all pneumatic ducts for supply, exhaust and for the working ports. The supply ducts are the central

component of the valve slices and enable a direct flow through the valve slices so that maximum flow rates can be achieved. All valves have a pneumatic pilot control for optimising

performance. The valve function is based on a piston spool system with patented sealing principle, ensuring a broad range of applications and long service life.

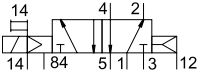
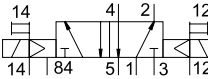
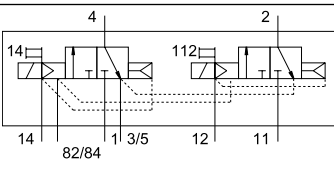
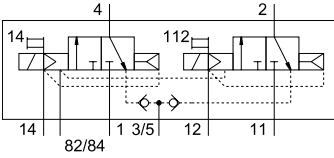
The valve manifold assembly is not suitable for vacuum operation!

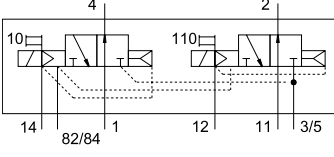
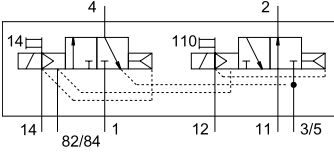
Valve function		
Code	Circuit symbol	Description
M		5/2-way valve, single solenoid <ul style="list-style-type: none"> • Pneumatic spring return • Piston spool valve
J		5/2-way valve, double solenoid <ul style="list-style-type: none"> • Piston spool valve • The pneumatic switching position is retained in the de-energised state
C		2x 3/2-way valve, single solenoid <ul style="list-style-type: none"> • Normally closed • Pneumatic spring return • Piston spool valve
CY		2x 3/2-way valve, single solenoid <ul style="list-style-type: none"> • Normally closed • Pneumatic spring return • Piston spool valve • Integrated back pressure protection <p> - Note If it is necessary to ensure that back pressure valves are securely closed in the event of a sudden loss or shutdown of the operating pressure, the valve manifold assembly must be operated with external pilot air supply.</p>
N		2x 3/2-way valve, single solenoid <ul style="list-style-type: none"> • Normally open • Pneumatic spring return • Piston spool valve • The function of a 5/3-way valve with mid-position pressurised can be achieved using these valves in the open initial position
H		2x 3/2-way valve, single solenoid <ul style="list-style-type: none"> • Normal position • 1x open (pilot control 12) • 1x closed (pilot control 14) • Pneumatic spring return • Piston spool valve <p>For optimised cylinder movement. With simultaneous actuation of both solenoid coils, corresponds to valve function M (5/2-way, single solenoid). As each side of the piston surface can be pressurised or exhausted independently from each other, faster movement of the cylinder is achieved.</p>

Key features – Pneumatic components

Valve function		
Code	Circuit symbol	Description
-	-	5/3G ¹⁾ function, mid-position closed The valve function "mid-position closed" is created using a 2x 3/2-way valve, normally closed (code C). The valve kit CPV10-BS-5/3G-M7 (incorporating a double piloted check valve function) is used for this. The valve kit is intended for use with one working pressure for each valve slice, i.e. it must not be used in dual-pressure operation (different pressure at port 1 and 11). If other valve slices are used in dual-pressure operation, a separator plate must be used to separate the valve slice equipped with the 5/3G valve kit from the compressed air duct 1 and 11 (code T). With pneumatic multiple connector plate P and M, not in the first or last valve position. Cannot be used with pneumatic multiple connector plate GQC and GQD. • Piston spool valve
-		5/3E function, mid-position exhausted The valve function "mid-position exhausted" is created using a 2x 3/2-way valve, normally closed (code C). • Pneumatic spring return • Piston spool valve
-		5/3B function, mid-position pressurised The valve function "mid-position pressurised" is created using a 2x 3/2-way valve, normally open (code N). • Pneumatic spring return • Piston spool valve
D		2x 2/2-way valve, single solenoid • Normally closed • Pneumatic spring return • Piston spool valve
I		2x 2/2-way valve, single solenoid • Normal position – 1x open (control side 12) – 1x closed (control side 14) • Pneumatic spring return • Piston spool valve

1) Cannot be installed in combination with the pneumatic multiple connector plate for control cabinets CPV10-VI-P...-C or CPV10-VI-P...-D

Key features – Pneumatic components

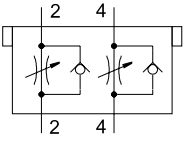
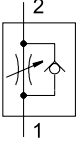
Additional pneumatic functions		
Code	Circuit symbol	Description
P		<p>2x one-way flow control valve, supply air flow control Module (attachment) for direct flange connection to the valves CPV. Also suitable for pneumatic multiple connector plate. It is not possible to combine different valve attachments.</p> <ul style="list-style-type: none"> • Not with valve function G • Not in the first or last valve position with accessories M, P, V (pneumatic multiple connector plate) • Cannot be used with accessories GQC or GQD (pneumatic multiple connector plate)
Q		<p>2x one-way flow control valve, exhaust air flow control Module (attachment) for direct flange connection to the valves CPV. Also suitable for pneumatic multiple connector plate. It is not possible to combine different valve attachments.</p> <ul style="list-style-type: none"> • Not with valve function G • Not in the first or last valve position with accessories M, P, V (pneumatic multiple connector plate) • Cannot be used with accessories GQC or GQD (pneumatic multiple connector plate)

 **Note**

Pneumatic multiple connector plate P, M: Not in first or last valve position.
Pneumatic multiple connector plate GQC, GQD: Cannot be used.

Key features – Pneumatic components

Creating pressure zones

Two pressure levels per valve are created using different pressure at port 1 and 11. Thus, for example, a cylinder drive can be advanced with high pressure and retracted with low pressure to save energy.

The maximum possible number of pressure zones is determined by the combination of the following components:

- Use of a separator plate
- Type of end plate pair

- Valve slice type

Separator plates can be used to divide the valve manifold assembly CPV into 2 to 4 pressure zones.

Separator plates		
Code	Graphical illustration	Note
T	<p>Separator plate for creating pressure zones, supply duct 1 and 11 are separate</p>	<p>Using one separator plate (code T), only the air supply duct (port 1 and 11) is interrupted to allow two pressure levels.</p> <ul style="list-style-type: none"> • Not in the first or last valve position • Not with compressed air supply A, B, C, D, U, V, W, X
S	<p>Separator plate for creating pressure zones, supply duct 1, 11 and exhaust 3, 5 are separate</p>	<p>The separator plate (code S) divides the exhaust duct 3/5 as well as the supply duct 1 and 11. This plate is used to prevent back pressures on adjacent valve functions.</p> <ul style="list-style-type: none"> • Not in the first or last valve position • Not with compressed air supply A, B, C, D, U, V, W, X • (single-side compressed air supply)
L	<p>Blanking plate (vacant position)</p>	<p>A blanking plate (code L) is used to provide a vacant position at which a valve can be inserted later.</p>

Key features – Pneumatic components

Examples: Pneumatic supply

External pilot air supply, flat plate silencer at both ends

Compressed air supply via pneumatic multiple connector plate:

Code H

The diagram on the right shows an example of the configuration and connection of the compressed air supply with external pilot air supply. Port 12/14 on the pneumatic multiple connector plate is equipped with a fitting for this purpose. Ports 3/5 and 82/84 are exhausted via the flat plate silencers. A separating seal each can be optionally used to create pressure zones.

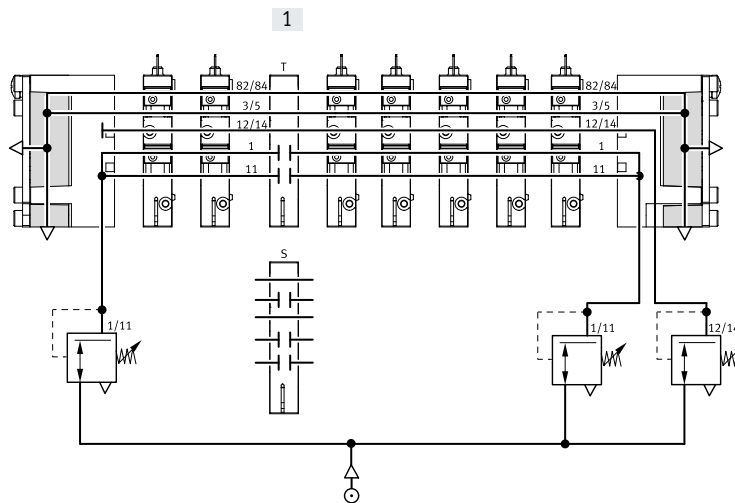

[1] Optional separating seal

Internal pilot air supply, ducted exhaust air or threaded silencer

Compressed air supply via end plates:
code Z

The diagram on the right shows an example of the configuration and connection of the compressed air supply with internal pilot air supply. The pilot air supply is branched from port 1 or 11 via the right-hand end plate. The exhaust 3/5 and 82/84 is expelled via the threaded silencer.

A separating seal each can be optionally used to create pressure zones.

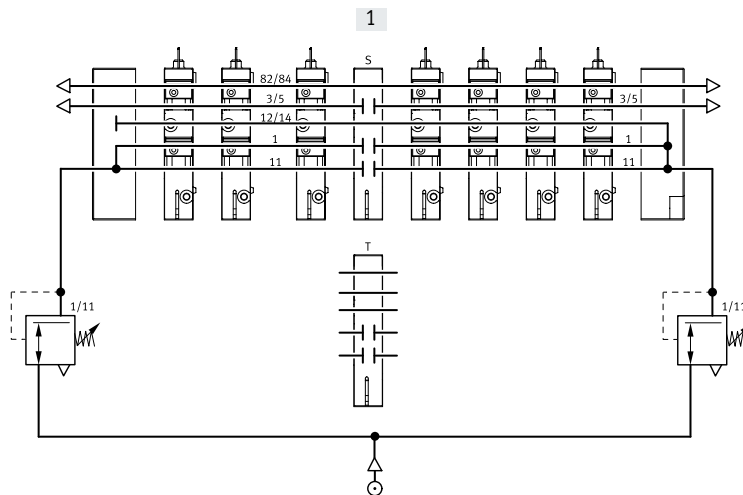

[1] Optional separating seal

Key features – Pneumatic components

Examples: Creating pressure zones

CPV with separator plate T

Up to 4 pressure zones can be created on valve manifold assemblies CPV. The diagram shows an example of the configuration and connection of four pressure zones using separator plate code T – with external pilot air supply.

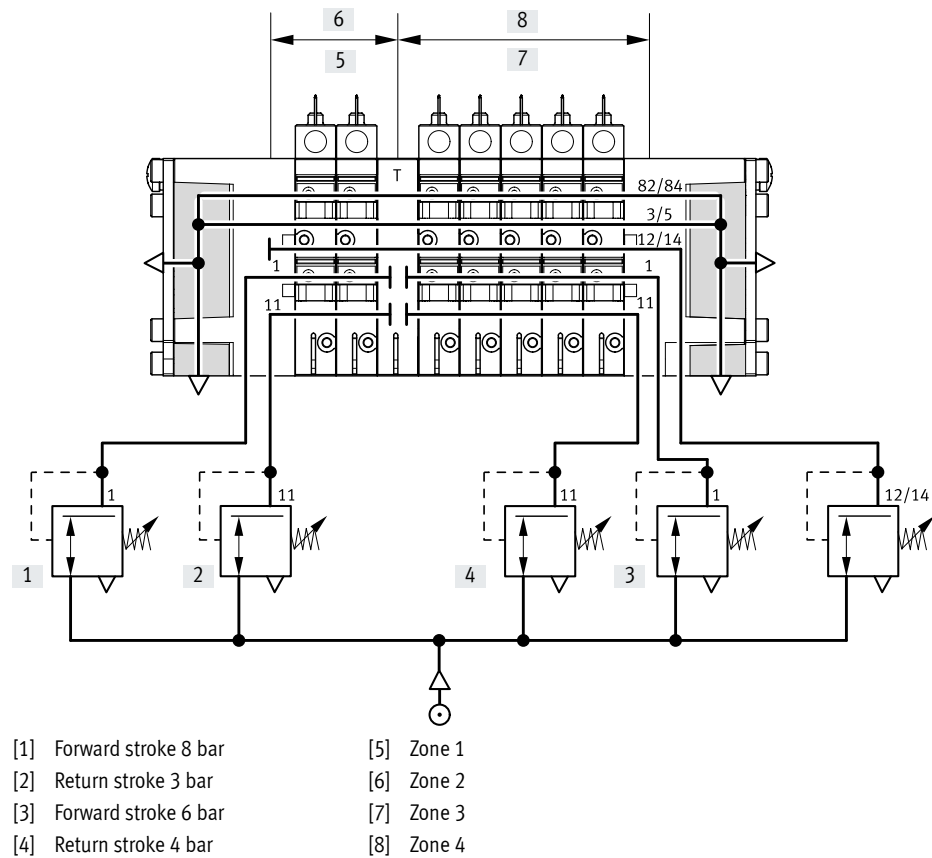

Key features – Pneumatic components

Compressed air supply and exhaust

A characteristic feature of a valve manifold assembly CPV is the two end plates which supply the valve slices with pressure and exhaust them.

- Large duct cross sections enable very high flow rate performance, even with several valves switching simultaneously

- Large flat plate silencers in the end plates
- Internal/external pilot air supply

Each individual valve is supplied with compressed air from two individual ducts (supply ports 1/11) and exhausted via a large integrated exhaust duct (exhaust 3/5). This design allows

unique functionality and flexibility, making it very easy to have multiple pressure zones per terminal.

The valve manifold assembly is supplied via end plates, either on the left, on the right or on both sides.

Pilot air supply

Internal pilot air supply

This can be selected if the supply pressure at pneumatic port 1 is 0.3 ... 0.8 MPa. With internal pilot air supply the branch is located in the left or right-hand end plate. There is no port 12/14.

External pilot air supply is required if the supply pressure at pneumatic port

External pilot air supply

1 is lower than 0.3 MPa or higher than 0.8 MPa. In this case, a pressure of 0.3 ... 0.8 MPa is applied at port 12/14.

If a gradual pressure build-up in the system using a soft-start valve is required, an external pilot air supply should be selected. In this case, the

control pressure applied during switch-on is already very high.

End plates

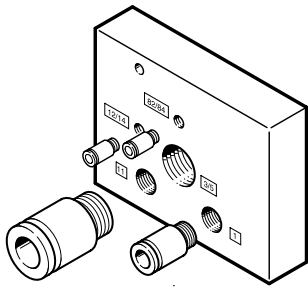

Example of an end plate:

The diagram shows a left-hand end plate with external pilot air supply. The exhaust ports 3/5 and 82/84 can be equipped with fittings or silencers. An end plate for internal pilot air supply does not have ports 12/14 and 11. Port 82/84 is always present and should be fitted with a silencer. With an end plate for internal pilot air

supply, port 12/14 is connected internally to port 1.

Key features – Pneumatic components

End plate combination for compressed air supply via end plate		Note
Code	Graphical illustration Type of pilot air supply (internal/external)	
U	<p>Internal pilot air supply</p>	<ul style="list-style-type: none"> • Ports in right-hand end plate only • No pressure zone separation permissible
V	<p>Internal pilot air supply</p>	<ul style="list-style-type: none"> • Ports in left-hand end plate only • No pressure zone separation permissible
W	<p>External pilot air supply</p>	<ul style="list-style-type: none"> • Ports in right-hand end plate only • No pressure zone separation permissible
X	<p>External pilot air supply</p>	<ul style="list-style-type: none"> • Ports in left-hand end plate only • No pressure zone separation permissible
Y	<p>Internal pilot air supply</p>	<ul style="list-style-type: none"> • Ports in left- and right-hand end plate • Maximum three pressure zones
Z	<p>External pilot air supply</p>	<ul style="list-style-type: none"> • Ports in left- and right-hand end plate • Maximum four pressure zones

Key features – Pneumatic components

End plate combination for compressed air supply via pneumatic multiple connector plate		
Code	Graphical illustration Type of pilot air supply (internal/external)	Note
Y	<p>Internal pilot air supply</p>	<ul style="list-style-type: none"> • Ports on pneumatic multiple connector plate • Pressure zone separation only permissible with separator plate (code T) • Maximum two pressure zones • Only for accessories M, P, V, GQC, GQD (pneumatic multiple connector plate)
Z	<p>External pilot air supply</p>	<ul style="list-style-type: none"> • Ports on pneumatic multiple connector plate • Pressure zone separation only permissible with separator plate (code T) • Maximum three pressure zones • Only for accessories M, P, V, GQC, GQD (pneumatic multiple connector plate)
End plate combination for compressed air supply via end plate with flat plate silencer		
Code	Graphical illustration Type of pilot air supply (internal/external)	Note
A	<p>Internal pilot air supply</p>	<ul style="list-style-type: none"> • Ports in right-hand end plate • No pressure zone separation permissible
B	<p>Internal pilot air supply</p>	<ul style="list-style-type: none"> • Ports in left-hand end plate • No pressure zone separation permissible
C	<p>External pilot air supply</p>	<ul style="list-style-type: none"> • Ports in right-hand end plate • No pressure zone separation permissible
D	<p>External pilot air supply</p>	<ul style="list-style-type: none"> • Ports in left-hand end plate • No pressure zone separation permissible

Key features – Pneumatic components

End plate combination for compressed air supply via pneumatic multiple connector plate with flat plate silencer		
Code	Graphical illustration Type of pilot air supply (internal/external)	Note
E	External pilot air supply 	<ul style="list-style-type: none"> • Ports on pneumatic multiple connector plate • Exhaust air vented via flat plate silencer on the right • Pressure zone separation only permissible with separator plate (code T) • Maximum four pressure zones • Only for accessories M, P, V, GQC, GQD (pneumatic multiple connector plate)
F	External pilot air supply 	<ul style="list-style-type: none"> • Ports on pneumatic multiple connector plate • Exhaust air vented via flat plate silencer on the left • Pressure zone separation only permissible with separator plate (code T) • Maximum four pressure zones • Only for accessories M, P, V, GQC, GQD (pneumatic multiple connector plate)
G	Internal pilot air supply 	<ul style="list-style-type: none"> • Ports on pneumatic multiple connector plate • Exhaust air vented via flat plate silencer on the left • Pressure zone separation only permissible with separator plate (code T) • Maximum three pressure zones • Only for accessories M, P, V, GQC, GQD (pneumatic multiple connector plate)
H	External pilot air supply 	<ul style="list-style-type: none"> • Ports on pneumatic multiple connector plate • Exhaust air vented via flat plate silencers at both ends • Pressure zone separation permissible • Only for accessories M, P, V, GQC, GQD (pneumatic multiple connector plate)
J	Internal pilot air supply 	<ul style="list-style-type: none"> • Ports on pneumatic multiple connector plate • Exhaust air vented via flat plate silencers at both ends • Pressure zone separation permissible • Maximum three pressure zones • Only for accessories M, P, V, GQC, GQD (pneumatic multiple connector plate)
K	Internal pilot air supply 	<ul style="list-style-type: none"> • Ports on pneumatic multiple connector plate • Exhaust air vented via flat plate silencer on the right • Pressure zone separation permissible • Maximum three pressure zones • Only for accessories M, P, V, GQC, GQD (pneumatic multiple connector plate)

Key features – Pneumatic components

Pneumatic connection

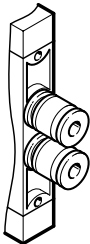

The working lines are located directly in the valve slices. Threaded connections and Quick Star push-in fittings (QS) are available for different tubing sizes.

The supply ports are located in the end plates or in the pneumatic multiple connector plate. Push-in fittings are available fully assembled. The following working lines can be selected:

- Threaded connections: code C
 - Push-in fittings, large: code D
 - Push-in fittings, small: code E
- Connection sizes for threads and QS push-in fittings can be found in the table below.

Pneumatic multiple connector plate

One-piece sub-bases are available for use with a pneumatic multiple connector plate; these contain the working ports and optionally also the supply ports. This allows the valve manifold assembly as a pneumatic "function" to be separated from the ports.

The pneumatic multiple connector plate enables different types of mounting, from wall mounting to direct passage through a housing wall.

Easy-to-service and flexible connection technology thanks to:

- Common connection via the pneumatic multiple connector plate with all connections on one side
- For mounting/dismounting, the valve manifold assembly is secured/released using just four screws

while the pneumatic tubing remains connected

- Minimal time required for mounting/dismounting
- No faults during recommissioning caused by incorrectly connected tubing

Valve manifold assembly CPV

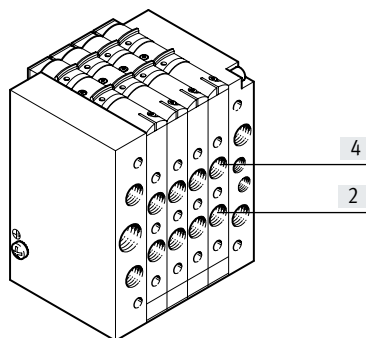

Pneumatic multiple connector plate

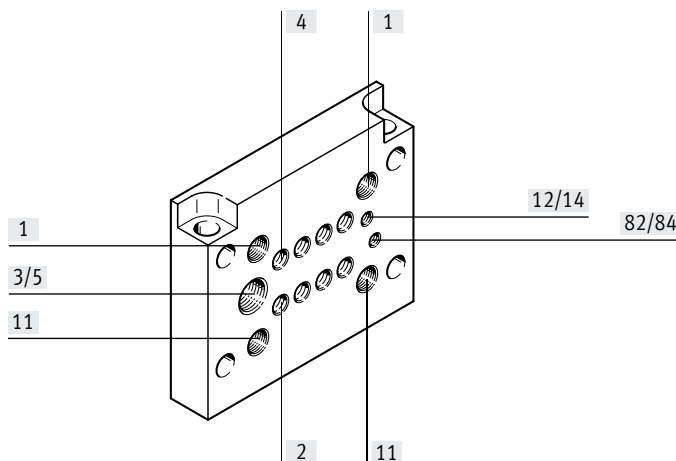

Connection sizes

Connection to ISO 5599		CPV10	Comment
1/11	Working air	G1/8	Fitting in end plate or pneumatic multiple connector plate
2/4	Working port	M7 (QS6/QS4)	Port in valve slice, push-in fitting via clips
3/5	Exhaust air via right-hand/left-hand end plate or Pneumatic multiple connector plate	G3/8 G1/4	–
12/14	Pilot air supply port	M5	–
82/84	Exhaust air via left-hand/right-hand end plate or Pneumatic multiple connector plate	M5 M7 (M5) ¹⁾	–

1) With pneumatic multiple connector plate with flange

Key features – Pneumatic components

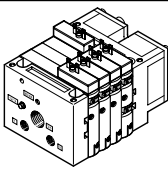
Pneumatic connection: fitting set for compressed air supply					
	Code Pneumatic supply	Connection	Designation	Type	
	Without pneumatic multiple connector plate				
	U, V	82/84	Silencer	AMTE-M-LH-M5	
		3/5	Silencer	U-3/8-B	
		1	Push-in fitting	QS-1/8-8-I	
	W, X	82/84	Silencer	AMTE-M-LH-M5	
		3/5	Silencer	U-3/8-B	
		1	Push-in fitting	QS-1/8-8-I	
		12/14	Push-in fitting	QSM-M5-6-I	
	Y	82/84 on right	Silencer	AMTE-M-LH-M5	
		82/84 on left	Blanking plug	B-M5	
		3/5 on right	Silencer	U-3/8-B	
		3/5 on left	Blanking plug	B-3/8	
		1/11 on left	Push-in fitting	QS-1/8-8-I	
	Z	82/84 on right	Silencer	AMTE-M-LH-M5	
		82/84 on left	Blanking plug	B-M5	
		3/5 on right	Silencer	U-3/8-B	
		3/5 on left	Blanking plug	B-3/8	
		12/14 on right	Push-in fitting	QSM-M5-6-I	
		12/14 on left	Blanking plug	B-M5	
		1/11	Push-in fitting	QS-1/8-8-I	
	With pneumatic multiple connector plate code: M				
	Y	82/84	Silencer	UC-M7	
		12/14	Blanking plug	B-M7	
		3/5	Silencer	U-1/4-B	
		1/11 on left	Push-in fitting	QS-1/8-8-I	
		11 on right	Blanking plug	B-1/8	
	Z	82/84	Silencer	UC-M7	
		3/5	Silencer	U-1/4-B	
		12/14	Push-in fitting	QSM-M7-6-I	
		1/11 on left	Push-in fitting	QS-1/8-8-I	
With pneumatic multiple connector plate code: P, GQC					
Y	82/84	Silencer	AMTE-M-LH-M5		
	12/14	Blanking plug	B-M5		
	3/5	Silencer	U-1/4-B		
	1/11 on left	Push-in fitting	QS-1/8-8-I		
	11 on right	Blanking plug	B-1/8		
Z	82/84	Silencer	AMTE-M-LH-M5		
	3/5	Silencer	U-1/4-B		
	12/14	Push-in fitting	QSM-M5-6-I		
	1/11 on left	Push-in fitting	QS-1/8-8-I		

Key features – Pneumatic components

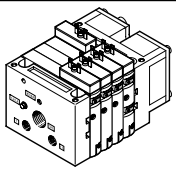
Pneumatic connection: fitting set for compressed air supply				
Code Pneumatic supply	Connection	Designation	Type	
	Without pneumatic multiple connector plate			
	A, B	82/84	Blanking plug	B-M5
		3/5	Blanking plug	B-3/8
		1	Push-in fitting	QS-1/8-8-I
	C, D	82/84	Blanking plug	B-M5
		3/5	Blanking plug	B-3/8
		1	Push-in fitting	QS-1/8-8-I
		12/14	Push-in fitting	QSM-M5-6-I
	With pneumatic multiple connector plate code: M			
	E, F, H	82/84	Blanking plug	B-M7
		3/5	Blanking plug	B-1/4
		1/11	Push-in fitting	QS-1/8-8-I
		12/14	Push-in fitting	QSM-M7-6-I
	G, J, K	82/84	Blanking plug	B-M7
		3/5	Blanking plug	B-1/4
		On right in 1, left	Push-in fitting	QS-1/8-8-I
		On right in 11	Blanking plug	B-1/8
		12/14	Blanking plug	B-M7
	With pneumatic multiple connector plate code: P, GQC			
	E, F, H	82/84	Blanking plug	B-M5
3/5		Blanking plug	B-1/4	
1/11		Push-in fitting	QS-1/8-8-I	
12/14		Push-in fitting	QSM-M5-6-I	
G, J, K	82/84	Blanking plug	B-M5	
	3/5	Blanking plug	B-1/4	
	On right in 1, left	Push-in fitting	QS-1/8-8-I	
	On right in 11	Blanking plug	B-1/8	
	12/14	Blanking plug	B-M5	

Key features – Pneumatic components

Valve manifold assembly CPV with valve extensions

Function blocks

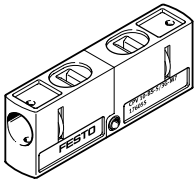

CPV10-BS-5/3G-M7

Valve kit 5/3G for creating a 5/3-way function, mid-position closed:
The valve function "mid-position closed" is created using a valve slice with 2x 3/2-way valve, normally closed (code C).
The valve kit CPV10-BS-5/3G-M7 (incorporating a double piloted check valve function) is used for this.
The valve kit is intended for use with one working pressure for each valve

slice, i.e. it must not be used in dual-pressure operation (different pressure at port 1 and 11).

Additional functions for valve positions

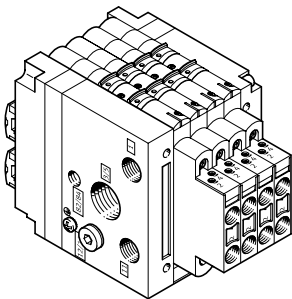

The valve manifold assembly CPV can be enhanced with further pneumatic functions with the aid of these valve extensions (vertical stacking):

- One-way flow control valves x2 for flow control directly at the valve manifold assembly for
 - Supply air flow control
 - Exhaust air flow control

Note
The additional functions cannot be used on the first or last valve position in combination with a pneumatic multiple connector plate M, P, and cannot be used at all in combination with a pneumatic multiple connector plate GQC, GQD.

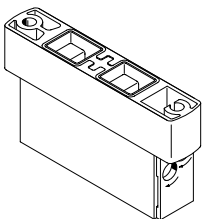

CPV10-BS-2xGRZZ-M7

- 2x one-way flow control valve for supply air flow control
- Additional function code P

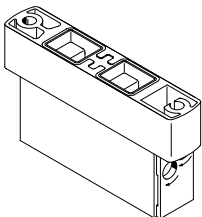

CPV10-BS-2xGRAZ-M7

- 2x one-way flow control valve for exhaust air flow control
- Additional function code Q

Key features – Mounting

Mounting options

The valve manifold assemblies have drilled holes for four retaining screws, with the side for the pneumatic fittings being the screw-on surface. These drilled holes are also used to mount a valve manifold assembly on the pneumatic multiple connector plate.

As well as this type of mounting, there are other mounting options:

- H-rail mounting
- Wall mounting
- Wall mounting via pneumatic multiple connector plate with flange

- On rear side via wall mounting
- On the front
- Mounting via through-hole in wall

The mountings are attached to the left- and right-hand end plates using a screw and a fixing bolt.

Mounting for H-rail

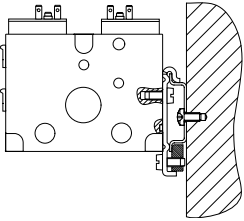

For valve manifold assembly CPV10:
CPV10/14-VI-BG-NRH-35
(Mounting code H)

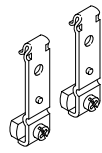

H-rail to EN 60715 not for accessories
M, P, V (pneumatic multiple connector
plate)

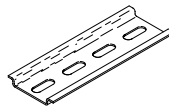

Attachment for wall mounting

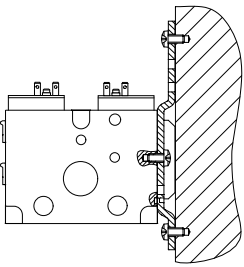

For valve manifold assembly CPV10:
CPV10/14-VI-BG-RWL-B
(Mounting code U)

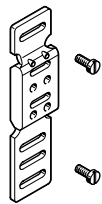

Through-hole in wall, e.g. on the machine

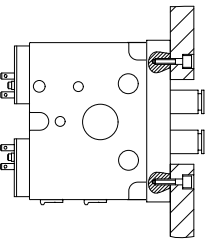

Wall mounting via pneumatic multiple connector plate

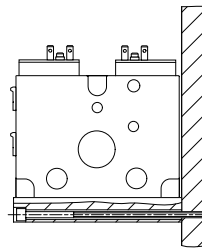

Key features – Mounting

Pneumatic multiple connector plate for wall/machine mounting

With flange, code P

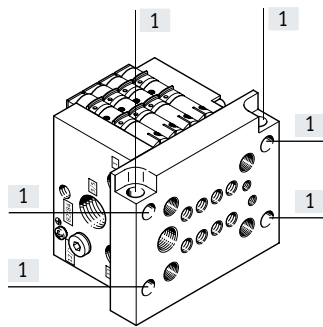

- Multiple connector plate protrudes at the end plates
- Through-holes for mounting (no thread) in the flange
- Two additional holes running crossways through this pneumatic multiple connector plate also allow rear mounting of valve manifold assembly CP.

[1] Mounting holes

Without flange, code M

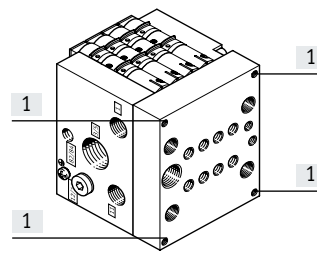

- Multiple connector plate ends flush with the end plates
- Mounting holes (with thread) for wall or base mounting in the connection side of the pneumatic multiple connector plate

[1] Mounting holes

Pneumatic multiple connector plate for control cabinet installation

With supply ports, code GQC

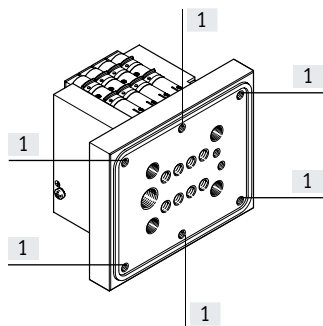

- Multiple connector plate protrudes at the end plates
- Mounting holes (with thread) in the flange
- Multiple connector plate with seal

[1] Mounting holes

Without supply ports, code GQD

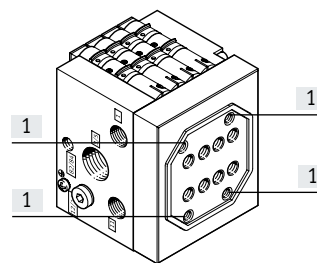

- Multiple connector plate ends flush with the end plates
- The mounting holes (with thread) are in the connection side of the pneumatic multiple connector plate
- Multiple connector plate with seal

[1] Mounting holes

With supply ports, code GQE

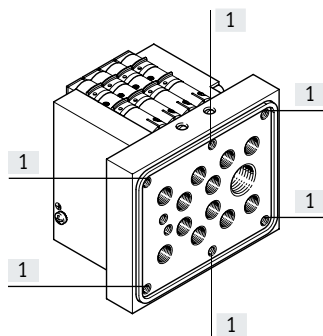

- Multiple connector plate protrudes at the end plates
- Mounting holes (with thread) in the flange
- Multiple connector plate with seal
- Working port 1/8"

[1] Mounting holes

Note

When using the pneumatic multiple connector plate M or P, the outermost valve slices cannot be fitted with valve extensions (e.g. one-way flow control valve).

Valve manifold assemblies CPV with flat plate silencer can only be mounted on a wall.

When using the pneumatic multiple connector plate GQC, GQD or GQE, the following restrictions apply:

- In general, no valve extensions can be fitted
- Cannot be combined with H-rail mounting
- Cannot be combined with wall mounting

Key features – Display and operation

Manual override

Three types of manual override are available:

- Non-detenting via slide
- Detenting
- Blocked

A subsequent conversion of the manual override (MO) from non-detenting to detenting or blocked is possible at any time.

To do this, the valve locking mechanism must first be removed. This is only possible when the individual valve is not installed or by removing the tie rod on the valve manifold assembly.



Note

Follow the instructions in the user documentation when doing this.

Code	Graphical illustration	Note
N	<p>Manual override, non-detenting</p>	<p>In the "non-detenting" version, a locking mechanism prevents the blue slider from moving. The manual override is activated using a pointed object (ballpoint pen or similar) through the opening.</p>
R	<p>Manual override, detenting</p>	<p>In the "detenting" version, the manual override is activated by sliding the slider. A locking mechanism can be used to provide the non-detenting function.</p>
V	<p>Manual override, blocked</p>	<p>In the "blocked" version, the detenting or non-detenting activation is prevented by a cover. As with the non-detenting locking mechanism, this can be added subsequently, but then remains on the valve.</p>

Key features – Display and operation

Display and operation

Inscription labels

- Clip with identification field on the cable socket

Valve manifold assembly CPV with individual connection

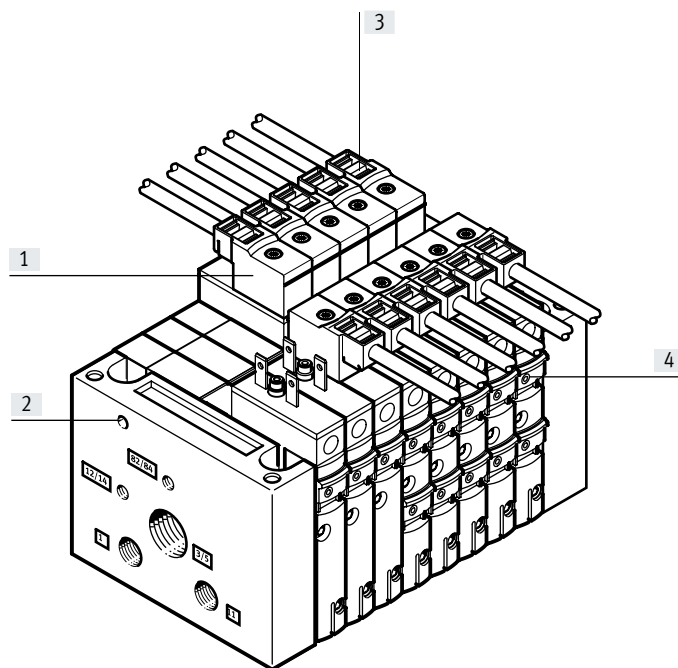

- [1] Pre-assembled connecting cable for each solenoid coil
- [2] Earth terminal
- [3] Inscription label (for each connection socket)
- [4] Manual override

Key features – Electrical components

Electrical connection

Individual connection

The corresponding connecting cables are generally designed without an LED. The CPV10-EX-VI is only approved for use in suitable intrinsically safe

circuits. A wide range of well-known manufacturers (list on request) offer appropriate controllers, barriers or

fieldbus circuits with intrinsically safe outputs.

2 to 16 solenoid coils (divided between 2 to 8 valve slices) can be selected, including odd numbers. The pneumatic multiple connector plate can only be used with an even number

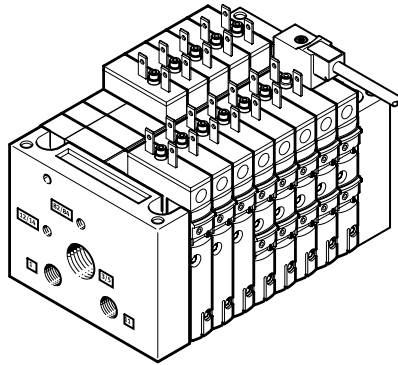

Note

The maximum total length of the electrical connecting cables per coil is 30 m.

This value also applies when the valve manifold assembly is installed in a control cabinet.

Ordering data

	Designation	Part no.	Type
Plug socket with cable			
	Plug socket with cable	0.5 m	550324 KMYZ-4-0.5B-EX
		2.5 m	550481 KMYZ-4-2.5-B-EX
		5.0 m	550482 KMYZ-4-5.0-B-EX
Inscription label			
	Inscription labels 6x10 mm, 64 pieces, in frame	18576	IBS-6x10

Dimensions – Connecting cable for individual connection

Download CAD data → www.festo.com

KMYZ-4-...-B-EX

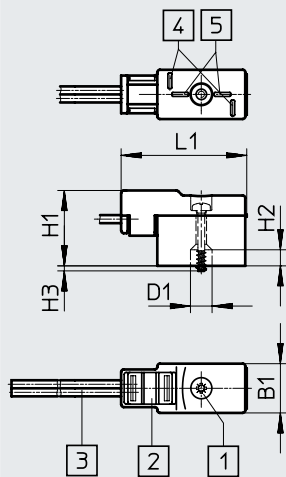

- | | |
|--|--|
| [1] Retaining screw (self-tapping KB 18x12), max. tightening torque 0.3 Nm | [3] 2-wire cable 0.5 m or 2.5 m (1x 0.35 mm ² 1x 0.34 mm ²) |
| [2] Inscription label | [4] Plug pattern for MSZB |
| | [5] Plug pattern for MSZC |

	B1	D1	H1	H2	H3	L1
KMYZ-4-...-B-EX	9.8	4.3	15	3.2	1	25

Instructions for use

Service fluids

Operate your system with unlubricated compressed air if possible. Festo valves and cylinders are designed so that, if used as intended, they will not require additional lubrication and will still achieve a long service life.

The quality of compressed air downstream of the compressor must correspond to that of unlubricated compressed air. If possible, do not operate the entire system with lubricated compressed air. The lubricators should, where possible, always be installed directly upstream of the actuator requiring them.

Incorrect additional oil and too high an oil content in the compressed air reduce the service life of the valve manifold assembly.

Use Festo special oil OFSW-32 or the alternatives listed in the Festo catalogue (as specified in DIN 51 524 HLP32; basic oil viscosity 32 CST at 40°C).

Bio-oils



When using bio-oils (oils which are based on synthetic or native esters, e.g. rapeseed oil methyl ester), the maximum residual oil content of 0.1 mg/m³ must not be exceeded (see ISO 8573-1 Class 2).

Mineral oils

When using mineral oils (e.g. HLP oils to DIN 51 524, parts 1 to 3) or similar oils based on poly-alpha-olefins (PAO), the maximum residual oil content of 5 mg/m³ must not be exceeded (see ISO 8573-1 Class 4).

A higher residual oil content is not permitted, regardless of the compressor oil, because the permanent lubrication would otherwise be flushed out over a period of time.

Data sheet

-  - Flow rate up to
400 l/min
-  - Valve width
10 mm
-  - Voltage
24 V DC

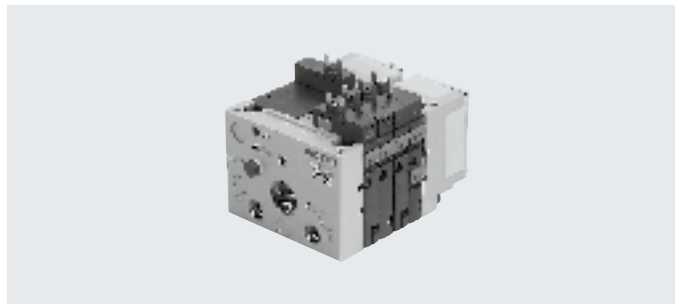

General technical data

Design	Electromagnetically actuated piston spool valve	
Lubrication	Life-time lubrication, PWIS-free (free of paint-wetting impairment substances)	
Type of mounting	Via pneumatic multiple connector plate	
	Via backwall	
	On H-rail	
Mounting position	Any	
Lap	Overlap	
Manual override	Non-detenting/detenting/blocked	
Width	[mm]	10
Nominal width	[mm]	4
Nominal flow rate without fitting	[l/min]	400
b value	0.4	
	0.35 ²⁾	
c value	1.6	
	[l/sbar]	
Degree of protection	Plug sockets	IP50
	Valve terminal	IP55
Pneumatic connections¹⁾		
Pneumatic connection	Via end plate or pneumatic multiple connector plate	
Supply port	1/11	G1/8
Exhaust port	3/5	G3/8 (G1/4)
Working ports	2/4	M7
Pilot air supply	12/14	M5 (M7)
Pilot exhaust air	82/84	M5 (M7)

1) Connection dimensions in brackets for pneumatic multiple connector plate

2) Values for 2x 2/2-way valve

Safety characteristics

Note on forced checking procedure	Switching frequency min. 1/week	
Max. positive test pulse with 0 signal	[µs]	1400
Max. negative test pulse with 1 signal	[µs]	700
Shock resistance	Shock test with severity level 2, to EN 60068-2-27	
Vibration resistance	Transport application test with severity level 2, to EN 60068-2-6	

Data sheet

Operating and environmental conditions		M	J	N	C	CY	H	D	I
Valve function order code									
Operating medium		Compressed air to ISO 8573-1:2010 [7:4:4] → page 27							
Note on the operating/pilot medium		Lubricated operation possible (in which case lubricated operation will always be required)							
Operating pressure	[MPa]	0 ... 1			0.01 ... 1		0 ... 1		
	[bar]	0 ... 10			0.1 ... 10		0 ... 10		
Operating pressure for valve manifold assembly with internal pilot air supply	[MPa]	0.3 ... 0.8							
	[bar]	3 ... 8							
Pilot pressure	[MPa]	0.3 ... 0.8							
	[bar]	3 ... 8							
Ambient temperature	[°C]	-5 ... +50							
Temperature of medium	[°C]	-5 ... +50							
Storage temperature	[°C]	-20 ... +40°C							
Relative air humidity at 25°C	[%]	90 with no condensation							
Note on materials		RoHS-compliant							
Certification		c UL us - Recognized (OL) C-Tick							

ATEX		
ATEX category gas	II 2G	
Type of ignition protection for gas	Ex ib IIC T4 Gb	
ATEX category for dust	II 2D	
Type of ignition protection for dust	Ex ib IIIC T100°C Db	
Explosion-proof ambient temperature	[°C]	Pi 0,76W: -5°C ≤ Ta ≤ +50°C
	[°C]	Pi 0,93W: -5°C ≤ Ta ≤ +40°C
Certifications valve terminal		
Explosion protection certification outside the EU	EPL Gb (IEC-EX)	
	EPL Db (IEC-EX)	
	EPL Gb (CN)	
	EPL Db (CN)	
	EPL Gb (GB)	
	EPL Db (GB)	
Certificate issuing authority	IBExU 12 ATEX 1110X	
	IECEx IBE 13.0046X	
	TÜV 21 UKEX 7013 X	
	GYJ20.1646X	
CE marking (see declaration of conformity) ¹⁾	To EU Explosion Protection Directive (ATEX)	
	To EU RoHS Directive	
UKCA marking (see declaration of conformity) ¹⁾	To UK EX instructions	
	To UK RoHS instructions	

1) More information: www.festo.com/catalogue/... → Support/Downloads.

Data sheet

ATEX		
Approved pneumatic multiple connector plates for valve manifold assembly CPV10-EX-VI		
Pneumatic multiple connector plate	CPV10-VI-P...-C	CPV10-VI-P...-D
ATEX category gas	II 2G	
Type of ignition protection for gas	Ex ec IIC Gb	
ATEX category for dust	II 2D	
Type of ignition protection for dust	Ex tc IIIC Db	
ATEX ambient temperature [°C]	-10°C ≤ Ta ≤ +60°C	
Certificate issuing authority	IECEx TUR 12.0002X	
	TÜV 06 ATEX 7334 X	
	TÜV 21 UKEX 7013 X	
Explosion protection certification outside the EU	EPL Db (GB)	
	EPL Db (IEC-EX)	
	EPL Dc (IEC-EX)	
	EPL Gb (GB)	
	EPL Gb (IEC-EX)	
CE marking (see declaration of conformity) ¹⁾	To EU Explosion Protection Directive (ATEX)	
UKCA marking (see declaration of conformity) ¹⁾	To UK EX instructions	
	To UK RoHS instructions	

1) More information: www.festo.com/catalogue/... → Support/Downloads.



Note

The ATEX certification in accordance with the EU ATEX Directive only applies to fully assembled valve terminals.

Data sheet

Electrical data – Valve solenoid		
Width	[mm]	10
Max. ambient temperature	[°C]	+50
Max. input voltage U_i	[V DC]	32
Max. input current I_i	[A]	0.2
Max. input power P_i	[W]	0.76
Required current consumption	[A]	0.016
Effective internal inductance L_i	[μH]	L0
Effective internal capacitance C_i	[nF]	L0
Resistance R_{20}	[Ω]	920 ±5%
Power supply	Only from certified intrinsically safe circuits EEx ia IIC or ib IIC	
Duty cycle ED	[%]	100
Degree of protection to EN 60529	IP50 IP65 with pneumatic multiple connector plate for control cabinets	
Max. connecting cable length per coil	[m]	30

Valve switching times [ms]									
Valve function order code		M	J	N	C	CY	H	D	I
Switching times	On	17	–	17	17	17	17	15	15
	Off	40	–	37	37	37	37	17	17
	Changeover	–	10	–	–	–	–	–	–

Materials	
Valve slices	Die-cast aluminium
Valve module 5/3G	Die-cast aluminium, POM
Blanking plate/separator plate	PA
End plates	Die-cast aluminium
Flat plate silencer	Die-cast aluminium, PE
Pneumatic multiple connector plate	Wrought aluminium alloy
Seal	NBR

Product weight	
Approx. weights	[g]
End plates (2 pieces)	160
Pneumatic multiple connector plate	
• On valve manifold assembly with 2 valve positions	120
• On valve manifold assembly with 4 valve positions	165
• On valve manifold assembly with 6 valve positions	225
• On valve manifold assembly with 8 valve positions	270
Flat plate silencer	147
Blanking plate	25
Separator plate	25
Valve sub-base	73
Function element: 5/3G function	46
Function element: one-way flow control valve	25

Data sheet

Dimensions

Download CAD data → www.festo.com

Valve manifold assembly CPV10-EX-VI with supply ports in the end plates

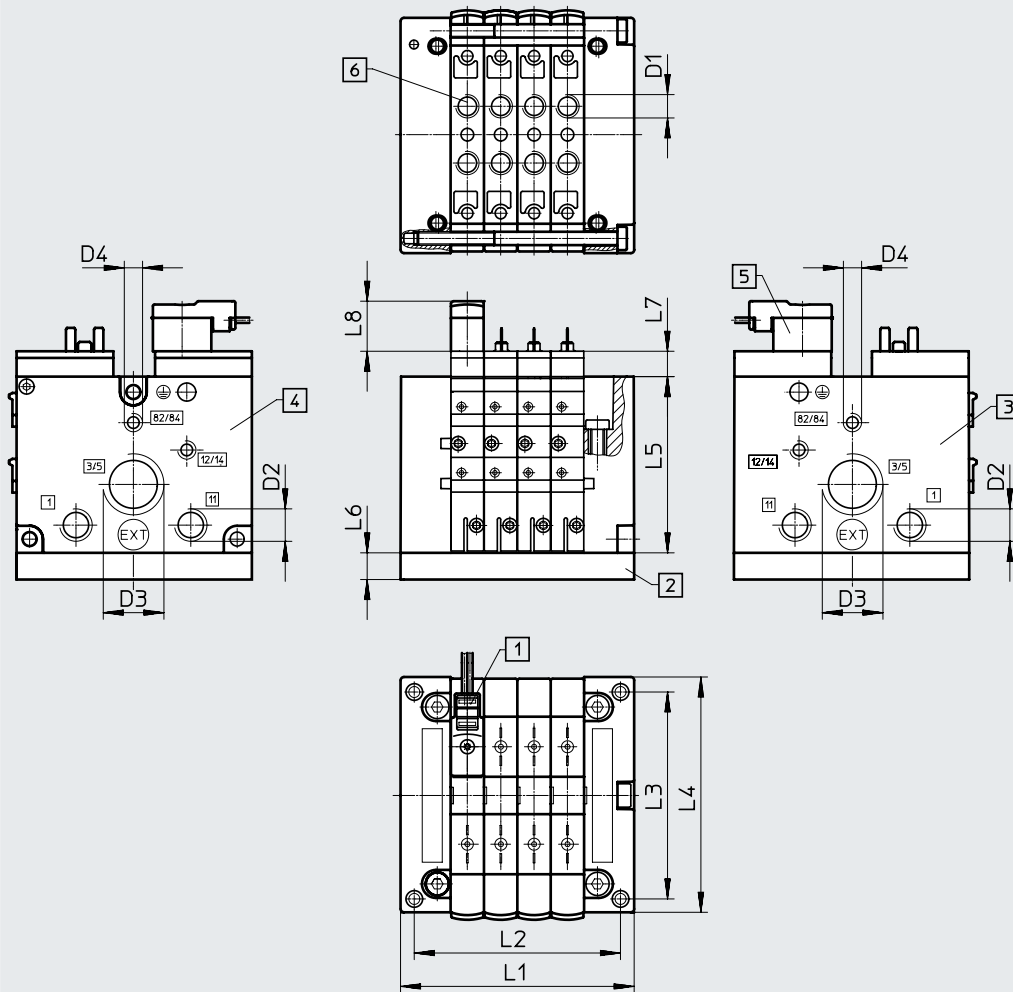

- [1] Slots for inscription label
- [2] Pneumatic multiple connector plate
- [3] Left-hand end plate (threaded connections not in combination with pneumatic multiple connector plate)
- [4] Right-hand end plate (threaded connections not in combination with pneumatic multiple connector plate)
- [5] Plug socket with cable type KMYZ-4-...
- [6] Individual threaded connection (without pneumatic multiple connector plate)

	L1	L2	L3	L4	L5	L6	L7	L8	D1	D2	D3	D4
2 slices	50	41.8	62	71	52.8	15	7.8	15	M7	G1/8	G3/8	M5
3 slices	60	51.8										
4 slices	70	61.8										
5 slices	80	71.8										
6 slices	90	81.8										
7 slices	100	91.8										
8 slices	110	101.8										

Data sheet

Dimensions

Download CAD data → www.festo.com

Valve manifold assembly CPV10-EX-VI with flat plate silencer

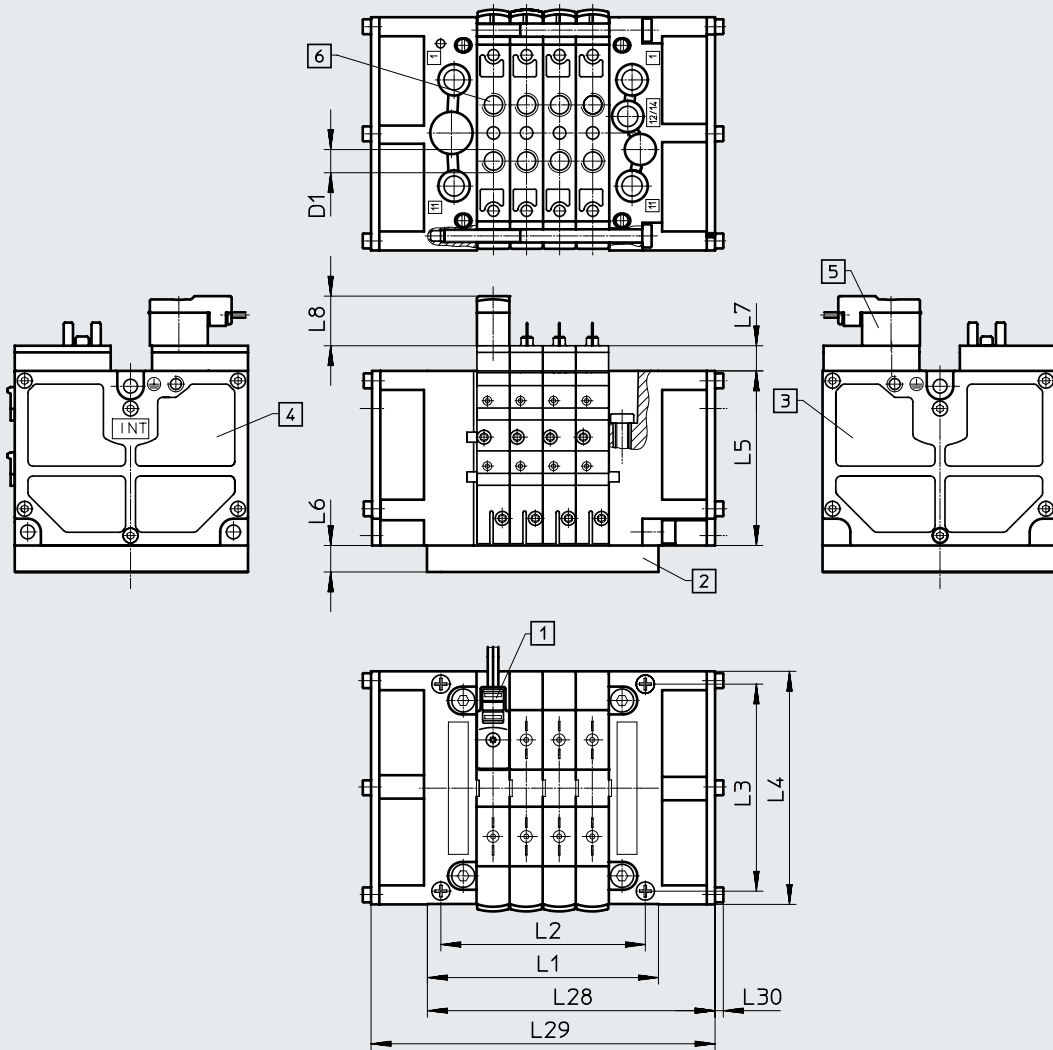

- [1] Slots for inscription label
- [2] Pneumatic multiple connector plate
- [3] Left-hand flat plate silencer
- [4] Right-hand flat plate silencer
- [5] Plug socket with cable KMYZ-4-...
- [6] Individual threaded connection (without pneumatic multiple connector plate)

	L1	L2	L3	L4	L5	L6	L7	L8	L28	L29	L30	D1
2 slices	50	41.8	62	71	52.8	15	7.6	15	67	84	2.5	M7
3 slices	60	51.8							77	94		
4 slices	70	61.8							87	104		
5 slices	80	71.8							97	114		
6 slices	90	81.8							107	124		
7 slices	100	91.8							117	134		
8 slices	110	101.8							127	144		

Data sheet

Dimensions

Download CAD data → www.festo.com

Wall mounting CPV10-VI-BG-RWL-B

[1] Valve manifold assembly
CPV10-EX-VI

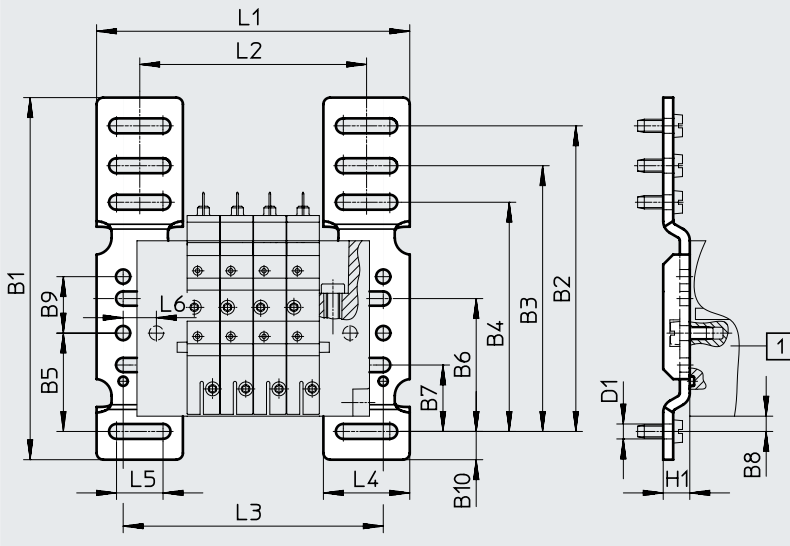

CPV10	2 slices	3 slices	4 slices	5 slices	6 slices	7 slices	8 slices
L1	74	84	94	104	114	124	134
L2	48	58	68	78	88	98	108
L3	58	78	88	98	108	118	128

	B1	B2	B3	B4	B5	B6	B7	B8	B9	B10	D1	H1	L4	L5	L6
CPV10	109	92	80	69	29.6	40	20	4.6	17	8.5	4.5	8	26	14	10

Data sheet

Dimensions

Download CAD data → www.festo.com

Attachment for H-rail mounting CPV10-VI-BG-NRH-35

- [1] Valve manifold assembly CPV10-EX-VI
- [2] H-rail to EN 60715

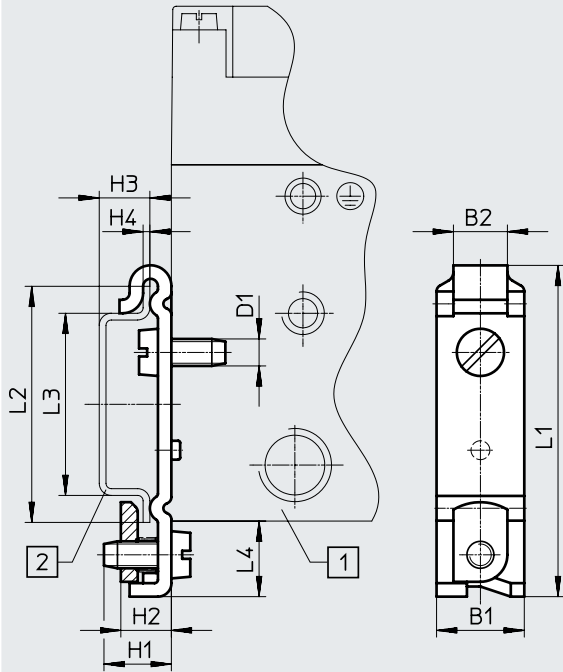

	B1 ±0.1	B2	D1	H1	H2	H3 -0.1	H4 ±0.1	L1	L2 ±0.1	L3 ±0.1	L4
CPV10	13	8	M4	10	7.5	7.5	1	49.1	35	27	11.2

Data sheet

Dimensions

Download CAD data → www.festo.com

Pneumatic multiple connector plate

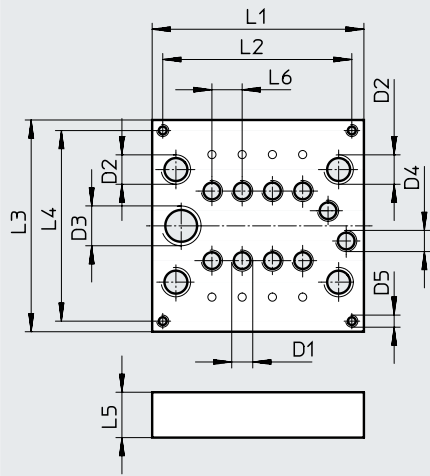

	L1	L2	L3	L4	L5	L6	D1	D2	D3	D4	D5
2 slices	49.5	42.5	70	63	15	10	M7	G1/8	G1/4	M7	M4
4 slices	69.5	62.5									
6 slices	89.5	82.5									
8 slices	109.5	102.5									

Pneumatic multiple connector plate with flange

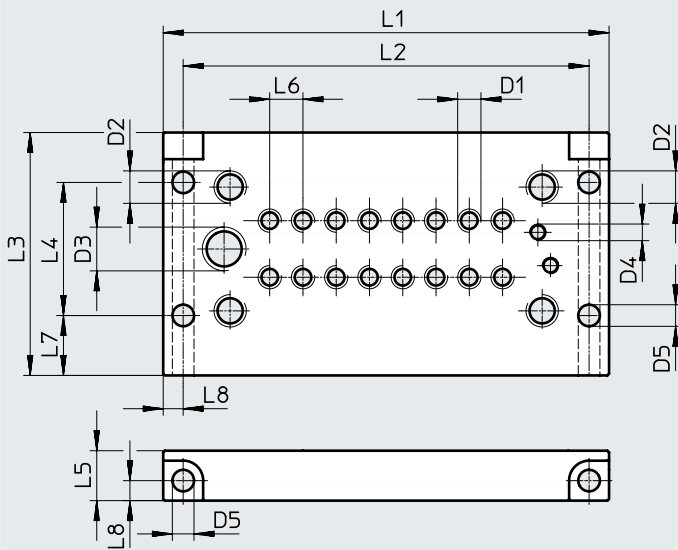

	L1	L2	L3	L4	L5	L6	L7	L8	D1	D2	D3	D4
2 slices	74	62	73	40	15	10	18	6	M7	G1/8	G1/4	M5
4 slices	94	82										
6 slices	114	102										
8 slices	134	122										

Data sheet

Dimensions

Download CAD data → www.festo.com

Pneumatic multiple connector plate for control cabinet installation, without supply ports

[1] Seal

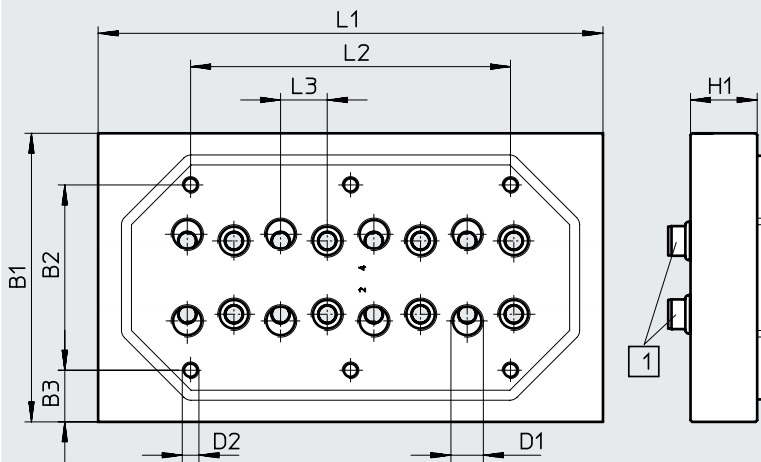

	L1	L2	L3	B1	B2	B3	D1	D2	H1
2 slices	49.5	-	10	70	40	15	M7	M5	10
4 slices	69.5	28							
6 slices	89.5	49							
8 slices	109.5	68							

Pneumatic multiple connector plate for control cabinet installation, with supply ports

[1] Seal

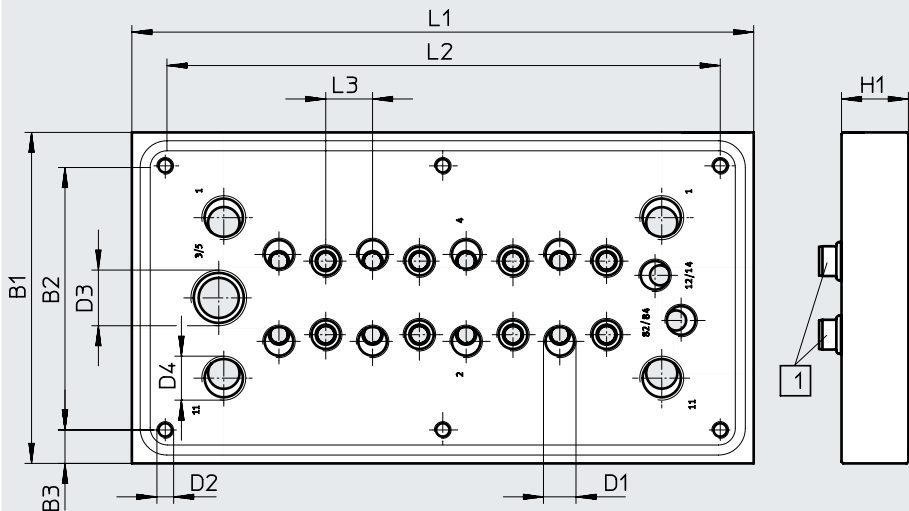

	L1	L2	L3	B1	B2	B3	D1	D2	D3	D4	H1
2 slices	82	62	10	84	64	10	M7	M5	G1/4	G1/8	15
4 slices	102	82									
6 slices	122	102									
8 slices	142	122									

Data sheet

Dimensions

Download CAD data → www.festo.com

Valve kit for 5/3-way function

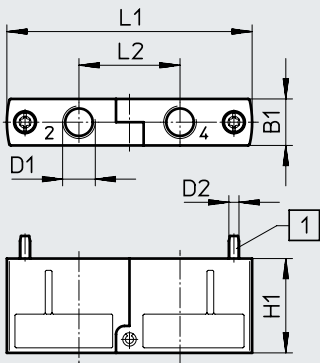

[1] Retaining screw enclosed separately

Type	B1	D1	D2	H1	L1	L2
CPV10-BS-5/3G-M7	9.9	M7	M2.5	22	55.8	23

Additional function – One-way flow control valve

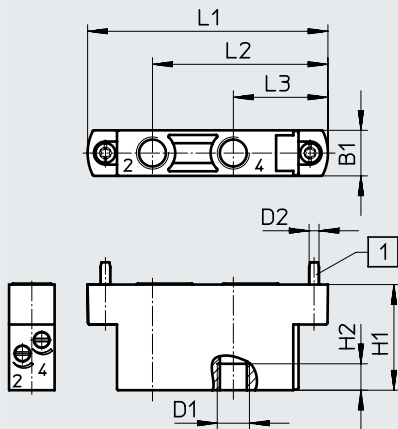

[1] Retaining screw enclosed separately

Type	B1	D1	D2	H1	H2	L1	L2	L3
CPV10-BS-2xGR...-M7	9.9	M7	M2.5	26	6	55.8	41.4	22.9
CPV10-BS-2xGRZV...-M7							-	



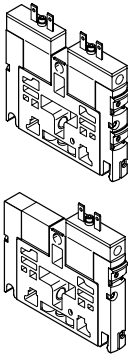

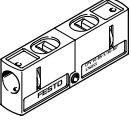
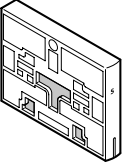
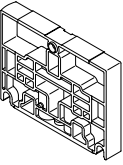
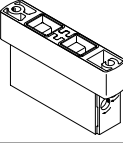
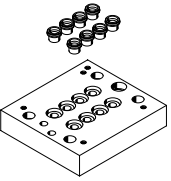

Accessories

Ordering data					
	Code	Valve function	Product weight [g]	Part no.	Type
Individual sub-base valve					
	M	5/2-way valve, single solenoid, piston spool valve	70	550696	CPV10-M1H-5LS-M7-B-EX
	J	5/2-way valve, double solenoid, piston spool valve		550697	CPV10-M1H-5JS-M7-B-EX
	N	2x 3/2-way valve, normally open, piston spool valve		550698	CPV10-M1H-2x3-OLS-M7-B-EX
	C	2x 3/2-way valve, normally closed, piston spool valve		550700	CPV10-M1H-2x3-GLS-M7-B-EX
	H	2x 3/2-way valve, 1x normally open, 1x normally closed, piston spool valve		550699	CPV10-M1H-3OLS-3GLS-M7-B-EX
	D	2x 2/2-way valve, normally closed, piston spool valve		550701	CPV10-M1H-2x2-GLS-M7-B-EX
	I	2x 2/2-way valve, 1x normally open, 1x normally closed, piston spool valve		550702	CPV10-M1H-2OLS-2GLS-M7-B-EX

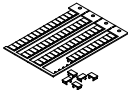
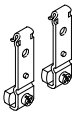
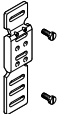
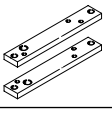
Accessories

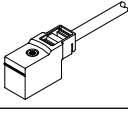
Ordering data		Code	Designation	Product weight [g]	Part no.	Type
Function block						
	G	Valve kit for 5/3-way valve function, closed (in combination with valve slice C)	23	176055	CPV10-BS-5/3G-M7	
Separator plates						
	T	Duct 1/11 closed	25	161369	CPV10-DZP	
	S	Duct 1/11, 3/5 closed		178678	CPV10-DZPR	
Blanking plate						
	L	Blanking plate	25	161368	CPV10-RZP	
Additional functions for valve positions						
	P	One-way flow control valve, 2x supply air	30	184140	CPV10-BS-2XGRZZ-M7	
	Q	One-way flow control valve, 2x exhaust air		184141	CPV10-BS-2XGRAZ-M7	
Pneumatic multiple connector plate						
	M	Pneumatic multiple connector plate, for wall/machine mounting, without side flange	2 slices	135	161969	CPV10-VI-P2-M7
			4 slices	164	161970	CPV10-VI-P4-M7
			6 slices	219	161971	CPV10-VI-P6-M7
			8 slices	272	163893	CPV10-VI-P8-M7
	P	Pneumatic multiple connector plate, for wall/machine mounting, with side flange	2 slices	182	152420	CPV10-VI-P2-M7-B
			4 slices	228	152421	CPV10-VI-P4-M7-B
			6 slices	283	152422	CPV10-VI-P6-M7-B
			8 slices	336	152423	CPV10-VI-P8-M7-B
	GQC	Pneumatic multiple connector plate with sealing ring, for control cabinet assembly, with supply ports	2 slices	250	538807	CPV10-VI-P2-M7-C
			4 slices	320	538808	CPV10-VI-P4-M7-C
			6 slices	390	538809	CPV10-VI-P6-M7-C
			8 slices	460	538810	CPV10-VI-P8-M7-C
	GQD	Pneumatic multiple connector plate with sealing ring, for control cabinet assembly, without supply ports	2 slices	80	538811	CPV10-VI-P2-M7-D
			4 slices	150	538812	CPV10-VI-P4-M7-D
			6 slices	220	538813	CPV10-VI-P6-M7-D
			8 slices	290	538814	CPV10-VI-P8-M7-D
-	Pneumatic multiple connector plate with sealing ring, for control cabinet assembly, with all ports	2 slices	300	566709	CPV10-VI-P2-1/8-C	
		4 slices	370	566710	CPV10-VI-P4-1/8-C	
		6 slices	440	566711	CPV10-VI-P6-1/8-C	
		8 slices	510	566712	CPV10-VI-P8-1/8-C	

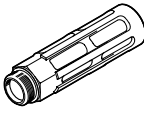
Accessories

Ordering data		Code	Designation	Product weight [g]	Part no.	Type
Inscription labels						
	-	6x10 mm in frame, 64 pieces	-	18576	IBS 6x10	
Mounting						
	H	Mounting for H-rail	15.8	162556	CPV10/14-VI-BG-NRH-35	
	U	Attachment for wall mounting	118	189541	CPV10/14-VI-BG-RWL-B	
	X	Attachment for individual connection	216	165801	CPV10-VI-BG-ET200X	
Manual override						
	-	Locking clip (for manual override), non-detachable	1.5	526203	CPV10/14-HS	
	V	Locking clip (cover for manual override)	0.15	530055	CPV10/14-HV	
Cable for individual connection, electrical						
	-	Plug socket with cable	0.5 m	12	550324	KMYZ-4-0.5-B-EX
	-		2.5 m	34.5	550481	KMYZ-4-2.5-B-EX
	-		5.0 m	62.5	550482	KMYZ-4-5.0-B-EX
Blanking plug						
	-	For thread M5	1	3843	B-M5	
	-	For thread M7	2	174309	B-M7	
	-	For thread G1/8	7	3568	B-1/8	
Push-in fitting						
	-	Connecting thread R1/8 for tubing O.D. 8 mm	8.8	153015	QS-1/8-8-I	
	-	Male thread M5, for tubing O.D. 6 mm	4.4	153317	QSM-M5-6-I	
	-	Male thread M7, for tubing O.D. 6 mm	6.4	153321	QSM-M7-6-I	
Silencer						
	-	For thread M5	1.5	1205858	AMTE-M-LH-M5	
	-	For thread G1/4	17	6842	U-1/4-B	
	-	For thread G3/8	37	6843	U-3/8-B	
	-	For thread M7	1.2	161418	UC-M7	
User documentation						
	-	CPV pneumatics manual	German	-	547039	P.BE-CPV10-EX-VI-DE
	-		English	-	547040	P.BE-CPV10-EX-VI-EN
	-		French	-	547041	P.BE-CPV10-EX-VI-FR
	-		Italian	-	547042	P.BE-CPV10-EX-VI-IT
	-		Spanish	-	547043	P.BE-CPV10-EX-VI-ES
	-		Swedish	-	547044	P.BE-CPV10-EX-VI-SV