

Membrane air dryers LDM1, D series

FESTO

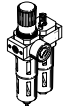

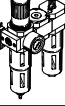

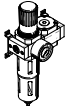
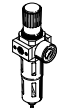
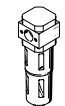
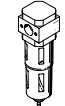
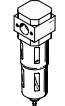
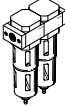
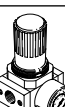

Product range overview – Service unit components, D series, metal

Type	Size	Pneumatic connection										Pressure regulation range [bar]			Grade of filtration [µm]					
		M5	M7	G1/8	G1/4	G3/8	G1/2	G3/4	G1	QS4	QS6	0.5 ...	0.5 ...	2.5 ...	0.01	1	5	40		
Service units																				
FRC/FRCS		Mini	-	-	■	■	■	-	-	-	-	-	■	■	-	-	-	■	■	
		Midi	-	-	-	■	■	■	■	-	-	-	■	■	-	-	-	■	■	
		Maxi	-	-	-	-	-	■	■	■	-	-	■	■	-	-	-	■	■	
FRC-K		Micro	-	-	-	-	-	-	-	-	-	-	■	■	-	-	-	-		
		Mini	-	-	■	■	-	-	-	-	-	-	■	■	-	-	-	-	■	
		Midi	-	-	-	■	■	■	-	-	-	-	■	■	-	-	-	-	■	
		Maxi	-	-	-	-	-	■	■	-	-	-	■	■	-	-	-	-	■	
LFR-K LFRS-K		Micro	-	-	-	-	-	-	-	-	-	-	■	■	-	-	-	-		
		Mini	-	-	■	■	-	-	-	-	-	-	■	■	-	-	-	-	■	
		Midi	-	-	-	■	■	■	-	-	-	-	■	■	-	-	-	-	■	
		Maxi	-	-	-	-	-	■	■	-	-	-	■	■	-	-	-	-	■	
Individual devices																				
Filter regulators LFR/LFRS		Mini	-	-	■	■	■	-	-	-	-	-	■	■	-	-	-	■	■	
		Midi	-	-	-	■	■	■	■	-	-	-	■	■	-	-	-	■	■	
		Maxi	-	-	-	-	-	■	■	■	-	-	■	■	-	-	-	■	■	
Filter LF		Mini	-	-	■	■	■	-	-	-	-	-	-	-	-	-	-	■	■	
		Midi	-	-	-	■	■	■	■	-	-	-	-	-	-	-	-	-	■	■
		Maxi	-	-	-	-	-	■	■	■	-	-	-	-	-	-	-	-	■	■
Fine and micro filter LFMA/LFMB		Micro	-	-	-	-	-	-	-	-	-	-	-	-	-	-	-	-		
		Mini	-	-	■	■	■	-	-	-	-	-	-	-	-	■	■	-	-	
		Midi	-	-	-	■	■	■	■	-	-	-	-	-	-	■	■	-	-	
		Maxi	-	-	-	-	-	■	■	■	-	-	-	-	-	■	■	-	-	
Activated carbon filter LFX		Micro	-	-	-	-	-	-	-	-	-	-	-	-	-	-	-	-		
		Mini	-	-	■	■	■	-	-	-	-	-	-	-	-	-	-	-		
		Midi	-	-	-	■	■	■	■	-	-	-	-	-	-	-	-	-		
Filter combinations LFMBA		Micro	-	-	-	-	-	-	-	-	-	-	-	-	-	-	-	-		
		Mini	-	-	■	■	■	-	-	-	-	-	-	-	■	■	-	-		
		Midi	-	-	-	■	■	■	■	-	-	-	-	-	■	■	-	-		
Pressure regulators LFR/LRS		Mini	-	-	■	■	■	-	-	-	-	■	■	-	-	-	-	-		
		Midi	-	-	-	■	■	■	■	-	-	-	■	■	-	-	-	-		
		Maxi	-	-	-	-	-	■	■	■	-	-	■	■	-	-	-	-		

Product range overview – Service unit components, D series, metal

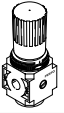
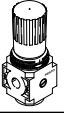
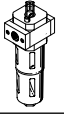
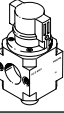
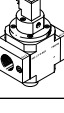
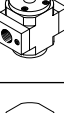
Type	Size	Bowl guard		Condensate drain			Pressure indication		Actuator lock		Supply voltage			Options			→ Page/ Internet
		Metal bowl guard	Plastic bowl	Manual	Semi-automatic	Fully automatic	With pressure gauge	Without pressure gauge	Rotary knob with latch	Rotary knob with integrated lock	24 V DC	110 V AC	230 V AC	Directly actuated pressure regulator with integrated return flow function	Pilot actuated pressure regulator with integrated return flow function	Differential pressure display	
Service units																	
FRC/FRCS	Mini	■	-	■	-	■	■	■	■	■	-	-	-	-	-	-	frc
	Midi	■	-	■	-	■	■	■	■	■	-	-	-	-	-	-	frc
	Maxi	■	-	■	-	■	■	■	■	■	-	-	-	■	■	-	frc
FRC-K	Micro	-	-	-	-	-	-	-	-	-	-	-	-	-	-	-	frc
	Mini	■	-	■	-	■	■	-	■	-	■	-	-	-	-	-	frc
	Midi	■	-	■	-	■	■	-	■	-	■	-	-	-	-	-	frc
	Maxi	■	-	■	-	■	■	-	■	-	■	-	-	■	■	-	frc
LFR-K LFRS-K	Micro	-	-	-	-	-	-	-	-	-	-	-	-	-	-	-	frc
	Mini	■	-	■	-	■	■	-	■	■	■	-	-	-	-	-	frc
	Midi	■	-	■	-	■	■	-	■	■	■	-	-	-	-	-	frc
	Maxi	■	-	■	-	■	■	-	■	■	■	-	-	■	■	-	frc
Individual devices																	
Filter regulators LFR/LFRS	Mini	■	-	■	-	■	■	■	■	■	-	-	-	-	-	-	lfr
	Midi	■	-	■	-	■	■	■	■	■	-	-	-	-	-	-	lfr
	Maxi	■	-	■	-	■	■	■	■	■	-	-	-	■	■	-	lfr
Filter LF	Mini	■	-	■	-	■	-	-	-	-	-	-	-	-	-	-	lf
	Midi	■	-	■	-	■	-	-	-	-	-	-	-	-	-	-	lf
	Maxi	■	-	■	-	■	-	-	-	-	-	-	-	-	-	-	lf
Fine and micro filter LFMA/LFMB	Micro	-	-	-	-	-	-	-	-	-	-	-	-	-	-	-	lfma, lfmb
	Mini	■	-	■	-	■	-	-	-	-	-	-	-	-	-	■	lfma, lfmb
	Midi	■	-	■	-	■	-	-	-	-	-	-	-	-	-	■	lfma, lfmb
	Maxi	■	-	■	-	■	-	-	-	-	-	-	-	-	-	■	lfma, lfmb
Activated carbon filter LFX	Micro	-	-	-	-	-	-	-	-	-	-	-	-	-	-	-	lfx
	Mini	■	-	-	-	-	-	-	-	-	-	-	-	-	-	-	lfx
	Midi	■	-	-	-	-	-	-	-	-	-	-	-	-	-	-	lfx
Filter combinations LFMBA	Micro	-	-	-	-	-	-	-	-	-	-	-	-	-	-	-	lfmba
	Mini	■	-	■	-	■	-	-	-	-	-	-	-	-	-	■	lfmba
	Midi	■	-	■	-	■	-	-	-	-	-	-	-	-	-	■	lfmba
	Maxi	■	-	■	-	■	-	-	-	-	-	-	-	-	-	■	lfmba
Pressure regulators LR/LRS	Mini	-	-	-	-	-	■	■	■	■	-	-	-	■	-	-	lr
	Midi	-	-	-	-	-	■	■	■	■	-	-	-	■	-	-	lr
	Maxi	-	-	-	-	-	■	■	■	■	-	-	-	■	■	-	lr

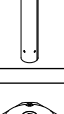
Product range overview – Service unit components, D series, metal

Type	Size	Pneumatic connection										Pressure regulation range [bar]		
		M5	M7	G1/8	G1/4	G3/8	G1/2	G3/4	G1	QS4	QS6	0.5 ... 7	0.5 ... 12	
Individual devices														
Pressure regulators LRB/LRBS		Micro	–											
		Mini	–	–	–	■	–	–	–	–	–	–	■	■
		Midi	–	–	–	–	■	–	–	–	–	–	■	■
		Maxi	–											
Pressure regulator manifolds LRB-K		Micro	–											
		Mini	–	–	–	■	■	–	–	–	–	–	■	■
		Midi	–	–	–	–	■	■	–	–	–	–	■	■
		Maxi	–											
Lubricators LOE		Mini	–	–	■	■	■	–	–	–	–	–	–	
		Midi	–	–	–	■	■	■	■	–	–	–	–	
		Maxi	–	–	–	–	–	■	■	■	–	–	–	
On/off valves HE		Micro	–											
		Mini	–	–	■	■	■	–	–	–	–	–	–	
		Midi	–	–	–	■	■	■	■	–	–	–	–	
		Maxi	–	–	–	–	–	■	■	■	–	–	–	
On/off valves HEE		Micro	–											
		Mini	–	–	■	■	■	–	–	–	–	–	–	
		Midi	–	–	–	■	■	■	■	–	–	–	–	
		Maxi	–	–	–	–	–	■	■	■	–	–	–	
On/off valves HEP		Micro	–											
		Mini	–	–	■	■	■	–	–	–	–	–	–	
		Midi	–	–	–	■	■	■	■	–	–	–	–	
		Maxi	–	–	–	–	–	■	■	■	–	–	–	
Soft-start valves HEL		Micro	–											
		Mini	–	–	■	■	■	–	–	–	–	–	–	
		Midi	–	–	–	■	■	■	■	–	–	–	–	
		Maxi	–	–	–	–	–	■	■	■	–	–	–	
Membrane air dryers LDM1		Micro	–											
		Mini	–											
		Midi	–											
		Maxi	–	–	–	–	–	■	■	■	–	–	–	
Branching modules FRM		Micro	–											
		Mini	–	–	■	■	■	–	–	–	–	–	–	
		Midi	–	–	–	■	■	■	■	–	–	–	–	
		Maxi	–	–	–	–	–	■	■	■	–	–	–	
Distributor block FRZ		Mini	–	–	–	–	–	–	–	–	–	–	–	
		Midi	–	–	–	–	–	–	–	–	–	–	–	
		Maxi	–	–	–	–	–	–	–	–	–	–	–	



Product range overview – Service unit components, D series, metal

Type	Size	Bowl guard		Pressure indication		Actuator lock		Supply voltage			Options		→ Page/ Internet	
		Metal bowl guard	Plastic bowl	With pressure gauge	Without pressure gauge	Rotary knob with latch	Rotary knob with integrated lock	24 V DC	110 V AC	230 V AC	With non-return function	Pressure switch		
Individual devices														
Pressure regulators LRB/LRBS	Micro	-				■	■	■	-	-	-	-	-	lrb
	Mini	-	-	-	■	■	■	-	-	-	-	-	-	
	Midi	-	-	-	■	■	■	-	-	-	-	-	-	
	Maxi	-	-											
Pressure regulator manifolds LRB-K	Micro	-												lrb
	Mini	-	-	-	■	■	-	-	-	-	-	-	-	
	Midi	-	-	-	■	■	-	-	-	-	-	-	-	
	Maxi	-	-											
Lubricators LOE	Mini	■	-	-	■	-	-	-	-	-	-	-	-	loe
	Midi	■	-	-	■	-	-	-	-	-	-	-	-	
	Maxi	■	-	-	■	-	-	-	-	-	-	-	-	
On/off valves HE	Micro	-												he
	Mini	-	-	-	■	■	-	-	-	-	-	-	-	
	Midi	-	-	-	■	■	-	-	-	-	-	-	-	
	Maxi	-	-	-	■	■	-	-	-	-	-	-	-	
On/off valves HEE	Micro	-												hee
	Mini	-	-	-	■	-	-	■	■	■	-	-	-	
	Midi	-	-	-	■	-	-	■	■	■	-	-	-	
	Maxi	-	-	-	■	-	-	■	■	■	-	-	-	
On/off valves HEP	Micro	-												hep
	Mini	-	-	-	■	-	-	-	-	-	-	-	-	
	Midi	-	-	-	■	-	-	-	-	-	-	-	-	
	Maxi	-	-	-	■	-	-	-	-	-	-	-	-	
Soft-start valves HEL	Micro	-												hel
	Mini	-	-	-	■	-	-	-	-	-	-	-	-	
	Midi	-	-	-	■	-	-	-	-	-	-	-	-	
	Maxi	-	-	-	■	-	-	-	-	-	-	-	-	
Membrane air dryers LDM1	Micro	-												6
	Mini	-												
	Midi	-												
	Maxi	■	-	-	■	-	-	-	-	-	-	-	-	
Branching modules FRM	Micro	-												frm
	Mini	-	-	-	■	-	-	-	-	-	■	■		
	Midi	-	-	-	■	-	-	-	-	-	■	■		
	Maxi	-	-	-	■	-	-	-	-	-	■	■		
Distributor block FRZ	Mini	-	-	-	■	-	-	-	-	-	-	-	-	frz
	Midi	-	-	-	■	-	-	-	-	-	-	-	-	
	Maxi	-	-	-	■	-	-	-	-	-	-	-	-	

Datasheet

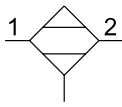
Function



-  - Flow rate
300 ... 1000 l/min
-  - Temperature range
+2 ... +50°C
-  - Operating pressure
3 ... 12.5 bar

Pressure dew point reduction:
LDM1-...-30 0/600: 20 K
LDM1-...-1000: 17 K



- Optimum final dryer with excellent operational reliability
- Suitable for use as an individual device or for integration into existing service unit combinations
- Flow rate-dependent dew point reduction
- Wear-free function requiring no external energy
- The composition of the compressed air remains almost unchanged due to the drying process
- 15% purge air flow rate with the LDM1-...-300/600 and 20% with the LDM1-...-1000

Typical areas of application:

- Drying, cleaning of precision parts
- Measurement technology
- Rinsing of precision glass scales
- Painting systems
- Paper and packaging machines

 **Note**
Prefiltration of the compressed air using a micro filter LFMA-D-MAXI, grade of filtration 0.01 µm (residual particles < 0.1 µm, residual oil content < 0.1 mg/m³) is vital for correct functioning of the device!

General technical data				
Size	Maxi			
Pneumatic connection 1, 2	G1/2	G3/4	G1	... ¹⁾
Design	Membrane dryer with internal air consumption			
Type of mounting	Via accessories In-line installation			
Mounting position	Vertical ±5°			

1) Without connecting plates

† Note: This product conforms to ISO 1179-1 and ISO 228-1.

Standard flow rate q _n [l/min]	LDM1-...-300 ¹⁾	LDM1-...-600 ¹⁾	LDM1-...-1000 ²⁾
Input q _{n In}	353	706	1250
Output q _{n Out}	300	600	1000
Purge air q _{n Purge}	52.9	105.9	250

1) Measured at p₁ = 6.9 bar, θ_{pd In} = 25°C, θ_{pd Out} = 5°C ± 1.5°C (θ_{pd Out} = -21.5°C ± 1.2°C), θ_{amb} = 25°C

2) Measured at p₁ = 6.9 bar, θ_{pd In} = 25°C, θ_{pd Out} = 8°C ± 1.5°C (θ_{pd Out} = -19.1°C ± 1.2°C), θ_{amb} = 25°C

Operating and environmental conditions	LDM1-...-300	LDM1-...-600	LDM1-...-1000
Type			
Operating pressure [bar]	3 ... 12.5		
Operating medium	Compressed air to ISO 8573-1:2010 [1:3:1]		
Pressure dew point reduction [K]	20	20	17
Ambient temperature [°C]	+2 ... +50		
Temperature of medium [°C]	+2 ... +50		
Storage temperature [°C]	-20 ... +60		
Corrosion resistance class CRC ¹⁾	2		

1) More information: www.festo.com/x/topic/crc

Datasheet

Weight [g] Connection	Without connecting plates	Connecting plates with threaded connection		
		G1/2	G3/4	G1
LDM1-...-300	1650	1800	1900	2000
LDM1-...-600	2100	2250	2350	2450
LDM1-...-1000	2100	2250	2350	2450

Materials

Sectional view

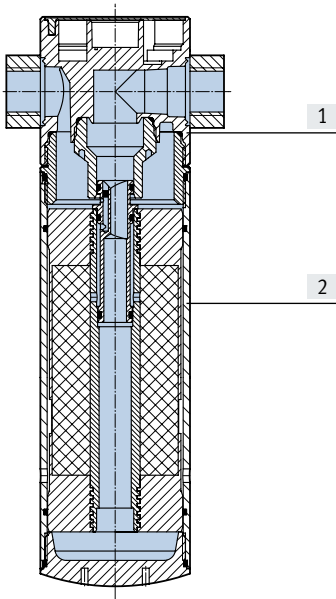

Membrane air dryer		
[1]	Housing	Die-cast zinc
[2]	Bowl	Wrought aluminium alloy
-	Seals	NBR
LABS (PWIS) conformity		VDMA24364-B1/B2-L

Datasheet

Pressure dew point t_{pd} (output) as a function of standard flow rate at output q_n ¹⁾

LDM1-...-300

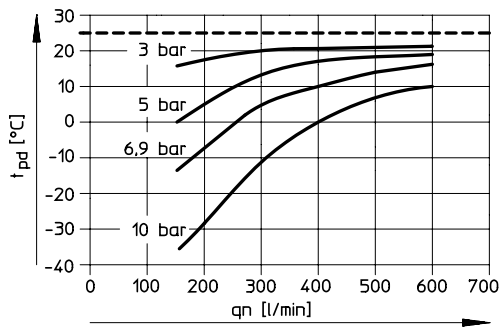

LDM1-...-600

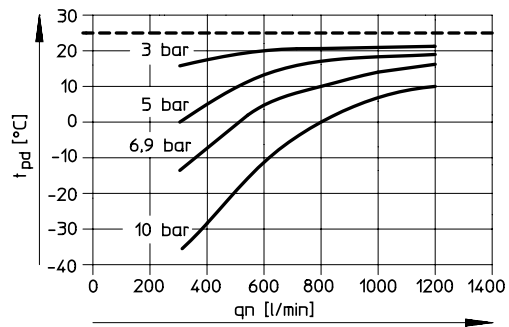

LDM1-...-1000

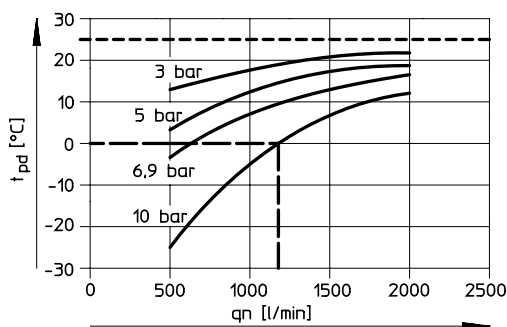

----- 1) Measured at pressure dew point t_{pd} (input) = 25°C.

----- Example LDM1-...-1000 with 10 bar input pressure:
At a standard flow rate of $q_n = 1200$ l/min,
the pressure dew point reduction is 25 K.

Differential pressure Δp as a function of the standard flow rate at output q_n

LDM1-...-300

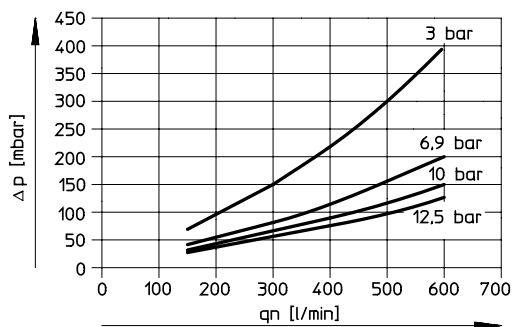

LDM1-...-600

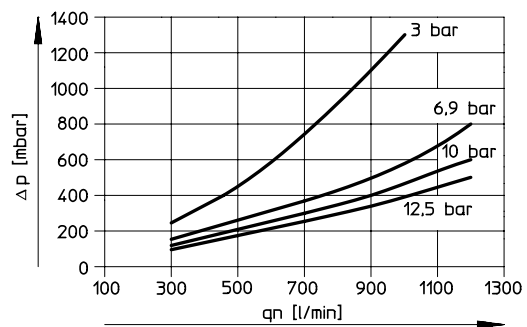

LDM1-...-1000

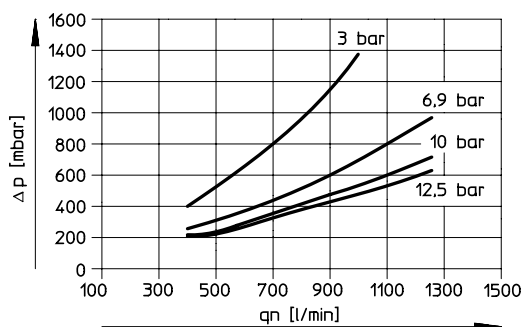

Datasheet

Dimensions

Download CAD data → www.festo.com

Maxi

With connecting plates with threaded connection

Without connecting plates

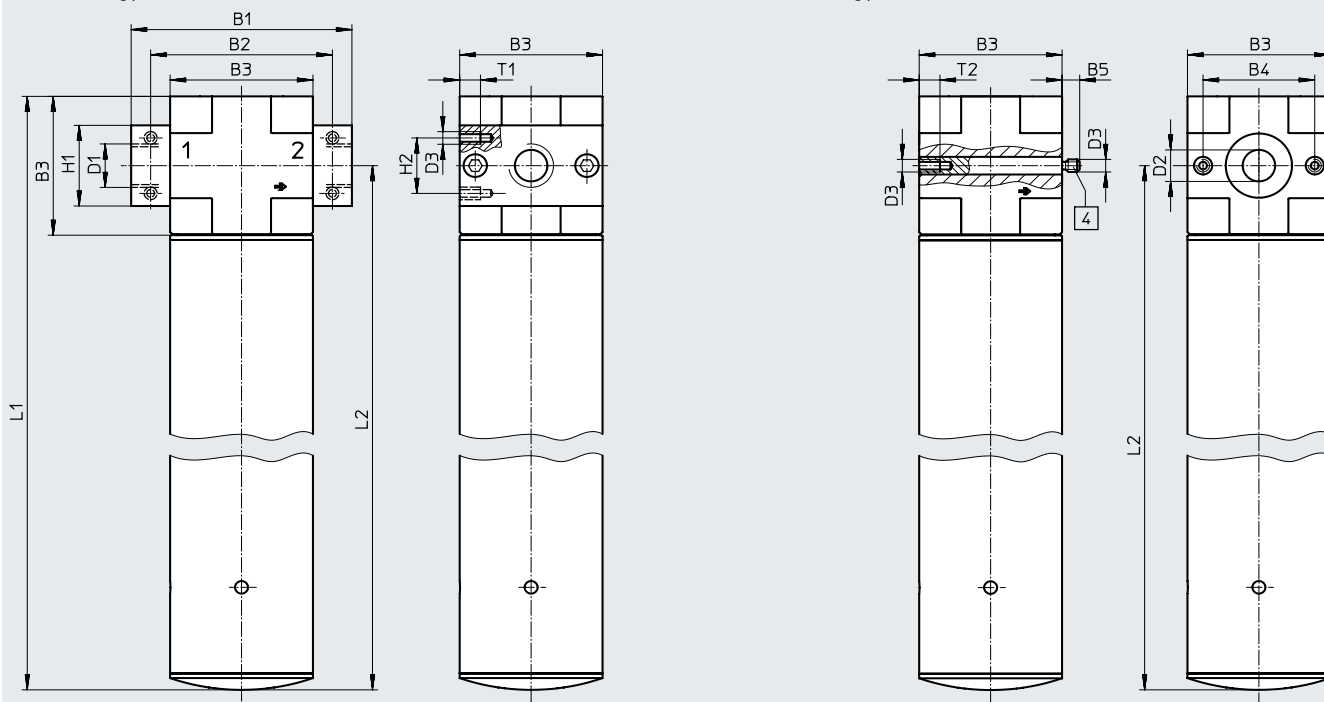

[4] Threaded bolt (exchangeable)

→ Flow direction

Type	B1	B2	B3	B4	B5	D1	D2 Ø	D3	H1	H2	L1	L2	T1	T2
LDM1-1/2-D-MAXI-300	96	80	66	46	-	G1/2	-	M5	32	22	329	296	8	-
LDM1-1/2-D-MAXI-600											519	486		
LDM1-1/2-D-MAXI-1000											519	486		
LDM1-3/4-D-MAXI-300	96	80	66	46	-	G3/4	-	M5	36	22	329	296	8	-
LDM1-3/4-D-MAXI-600											519	486		
LDM1-3/4-D-MAXI-1000											519	486		
LDM1-1-D-MAXI-300	116	91	66	46	-	G1	-	M5	41	22	329	296	8	-
LDM1-1-D-MAXI-600											519	486		
LDM1-1-D-MAXI-1000											519	486		
LDM1-D-MAXI-300	-	-	66	46	7	-	30	M5	-	-	329	296	-	11
LDM1-D-MAXI-600											519	486		
LDM1-D-MAXI-1000											519	486		

Note: This product conforms to ISO 1179-1 and ISO 228-1.

Ordering data

Size	Connection	LDM1-...-300		LDM1-...-600		LDM1-...-1000	
		Part no.	Type	Part no.	Type	Part no.	Type

Without connecting plates							
Maxi	-	543664	LDM1-D-MAXI-300	543665	LDM1-D-MAXI-600	543666	LDM1-D-MAXI-1000

Connecting plates with threaded connection							
Maxi	G1/2	543667	LDM1-1/2-D-MAXI-300	543668	LDM1-1/2-D-MAXI-600	543669	LDM1-1/2-D-MAXI-1000
	G3/4			543671	LDM1-3/4-D-MAXI-600	543672	LDM1-3/4-D-MAXI-1000
	G1	543673	LDM1-1-D-MAXI-300	543674	LDM1-1-D-MAXI-600	543675	LDM1-1-D-MAXI-1000