

Guided drives DFM/DFM-B

FESTO



Festo Core Range
Solves the majority of your automation tasks

Worldwide:
Simply good:
Fast:

Quickest delivery – wherever, whenever
Expected high Festo quality
Easy and fast to select

With the Festo Core Range, we have selected the most important products and functions from our broad product catalogue, and added the quickest delivery.

The Core Range offers you the best value for your automation tasks.

Just look
for the
star!

Key features

At a glance

Drive and guide in a single housing

Sturdy and precise

High torque and transverse force absorption

- Minimal space requirement
- Minimal mounting time
- Choice of supply ports
- Wide range of mounting options
- High resistance to torsion
- High rigidity
- Maintenance-free
- With plain-bearing guide: high rigidity thanks to large-diameter guide rods and four plain-bearing bushes
- With recirculating ball bearing guide: for movements involving torque loads

Wide choice of variants

Guided drive DFM

- Basic drive with strokes of up to 200 mm

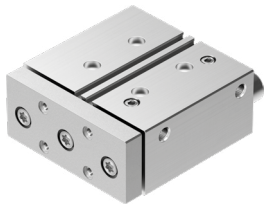

Guided drive DFM-B

- Drive with strokes of up to 400 mm
- With precision end-position adjustment
- With pneumatic cushioning, adjustable PPV
- With shock absorber, self-adjusting, progressive

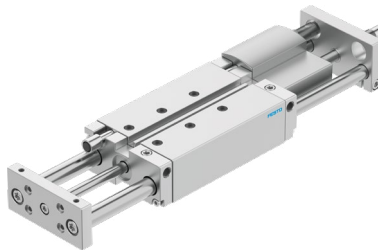

Application examples

Terminals

The guided drive is perfectly suited to clamping components for reliable further processing.



Lifting

The powerful and dynamic guided drive transports and lifts loads of more than 200 kg with ease.

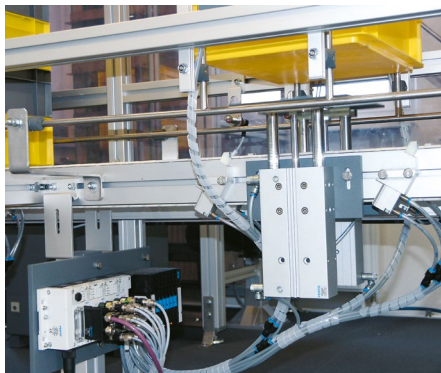

Stopping

Loads of up to 150 kg are stopped reliably and safely, making the guided drive a resilient and sturdy stopper cylinder.

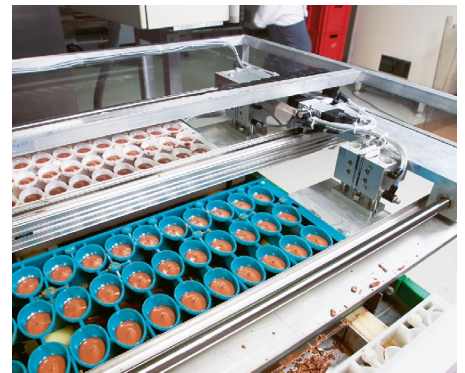

Key features

Use in conveyor technology

Lifting

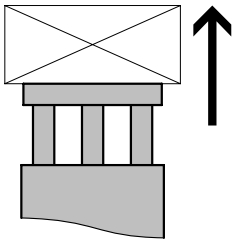

Pushing

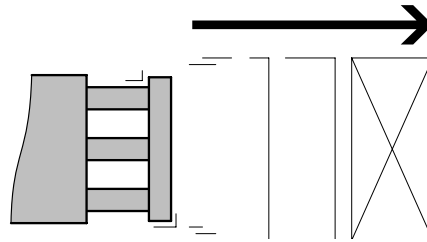

Stopping

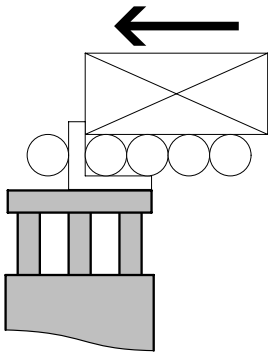

Stopping with stop bracket

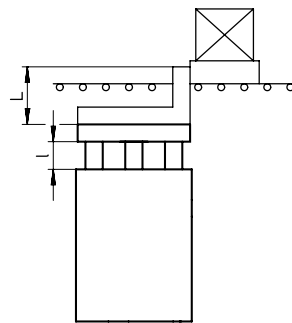

A buffer on the workpiece carrier is recommended!

Mounting options

Flat from the top

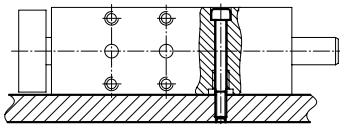

Flat from underneath

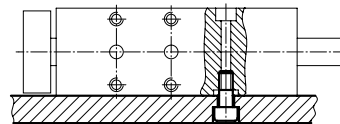

Sideways and underneath

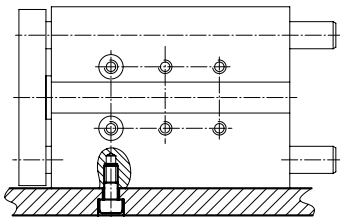

At the front

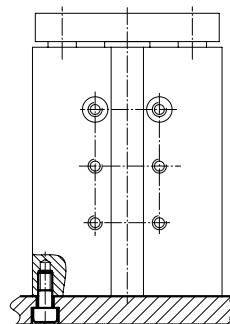

For manufacturing lithium-ion batteries

DFM-...-F1A

Recommended for production systems for manufacturing lithium-ion batteries.

Metals with copper, zinc or nickel as the main constituent are excluded from use. Exceptions are nickel in steels, chemically nickel-plated surfaces, printed circuit boards, cables, electrical plug connectors and coils.

Accessories

Please contact your Festo representative for information on which accessories are suitable for manufacturing lithium-ion batteries.

Product range overview

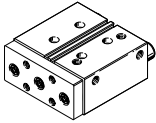
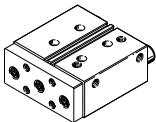
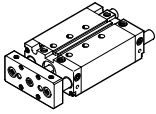
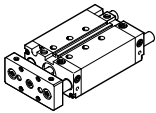
Function	Version	Type	Piston \varnothing [mm]	Stroke [mm]	Variable stroke [mm]
Double-acting	DFM basic version with recirculating ball bearing guide				
		DFM Piston rod at one end	12, 16	10, 20, 25, 30, 40, 50, 80, 100	–
			20, 25	20, 25, 30, 40, 50, 80, 100	–
			32	20, 25, 30, 40, 50, 80, 100, 125, 160, 200	–
			40, 50, 63, 80, 100	25, 50, 80, 100, 125, 160, 200	–
	DFM basic version with plain-bearing guide				
		DFM Piston rod at one end	6, 10	5, 10, 15, 20	–
			12, 16	10, 20, 25, 30, 40, 50, 80, 100	–
			20, 25	20, 25, 30, 40, 50, 80, 100	–
			32	20, 25, 30, 40, 50, 80, 100, 125, 160, 200	–
			40, 50, 63, 80, 100	25, 50, 80, 100, 125, 160, 200	–
	DFM-B with recirculating ball bearing guide				
		DFM-B Piston rod at one end	12, 16	10, 20, 25, 30, 40, 50, 80, 100, 125, 160, 200	10 ... 200
			20, 25, 32	20, 25, 30, 40, 50, 80, 100, 125, 160, 200, 250, 320, 400	20 ... 400
			40, 50, 63	25, 50, 80, 100, 125, 160, 200, 250, 320, 400	25 ... 400
	DFM-B with plain-bearing guide				
		DFM-B Piston rod at one end	12, 16	10, 20, 25, 30, 40, 50, 80, 100, 125, 160, 200	10 ... 200
			20, 25, 32	20, 25, 30, 40, 50, 80, 100, 125, 160, 200, 250, 320, 400	20 ... 400
			40, 50, 63	25, 50, 80, 100, 125, 160, 200, 250, 320, 400	25 ... 400

 **Note**

Engineering tool
 → www.festo.com/engineeringtools

Product range overview

Type	Position sensing	Recommended for production systems for manufacturing lithium-ion batteries	Cushioning			Heat-resistant seals	End-position adjustment		→ page/ Internet
			Not adjustable	Adjustable for heavy loads	Self-adjusting end position adjustable for large masses		Advanced end position, elastic cushioning	Retracted end position, elastic cushioning	
	A	F1A	P	PPV	YSRW	S6	AJ	EJ	
DFM basic version with recirculating ball bearing guide									
DFM Piston rod at one end	■	■ ∅ 12 ... 63	■	–	–	–	–	–	9
DFM basic version with plain-bearing guide									
DFM Piston rod at one end	■	■ ∅ 12 ... 63	■	–	–	–	–	–	9
DFM-B with recirculating ball bearing guide									
DFM-B Piston rod at one end	■	–	■	■ From ∅ 16	■ From ∅ 20	–	■	■ From ∅ 20	42
DFM-B with plain-bearing guide									
DFM-B Piston rod at one end	■	–	■	■ From ∅ 16	–	■	■	■ From ∅ 20	42

Type codes

001	Series	
DFM	Guided drive, double-acting	

002	Piston diameter [mm]	
6	6	
10	10	
12	12	
16	16	
20	20	
25	25	
32	32	
40	40	
50	50	
63	63	
80	80	
100	100	

003	Stroke range [mm]	
...	10 ... 400	

004	Generation	
	Standard	
B	Function-optimised	

005	Cushioning	
P	Elastic cushioning rings/plates on both sides	
PPV	Pneumatic cushioning, adjustable at both ends	
YSRW	Shock absorber, self-adjusting, progressive	

006	Position sensing	
A	For proximity sensor	

007	Guide	
GF	Plain bearing	
KF	Recirculating ball bearing guide	

008	Special material properties	
	None	
F1A	Recommended for production facilities for the manufacture of lithium-ion batteries	

009	Temperature range	
	Standard	
S6	Heat-resistant seals max. 120 °C	

010	Precision adjustment extended	
	None	
AJ	Precision adjustment in the end positions, advancing	

011	Precision adjustment retracting	
	None	
EJ	Precision adjustment in the end positions, retracting	

012	Slot cover, sensor slot	
	None	
...S	1 ... 10 pieces	

013	Proximity switch, with cable, 2.5 m	
	None	
...G	1 ... 10 pieces	

014	Proximity switch, contactless, with cable, 2.5 m	
	None	
...I	1 ... 10 pieces	

Peripherals overview

Piston \varnothing 6 ... 10

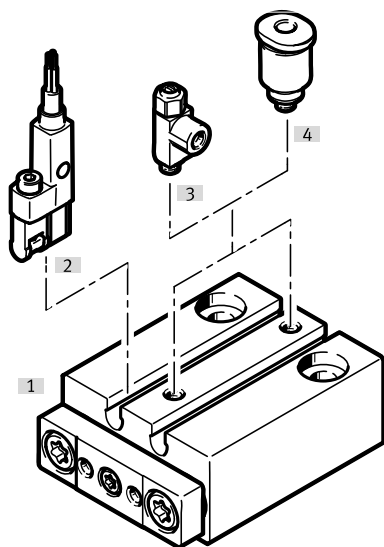

Accessories	Description	→ Page/Internet
[1] Guided drive DFM	Guided drive, basic version	9
[2] Proximity switch SMT-10G	Inserted into the slot lengthwise	75
[3] One-way flow control valve GRLA	For regulating speed	77
[4] Push-in fitting QSM/QS	For connecting tubing with standard O.D.	qs

Note
 Only the following push-in fitting/one-way flow control valve may be used in combination with proximity switch SMT-10G:

- QSM-M3-2-I
- GRLA-M3

Note
 Note the installation position of the proximity switches SMT-10G
 → User documentation

Extremely functional

Direction of movement

High resistance to torsion, torque and transverse force absorption

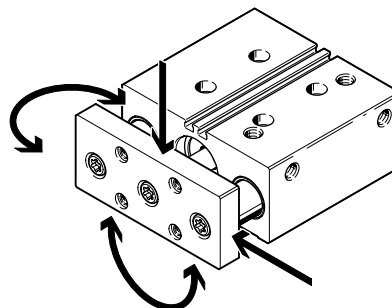
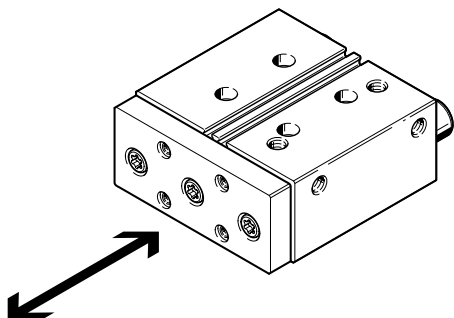

Peripherals overview

Piston \varnothing 12 ... 100

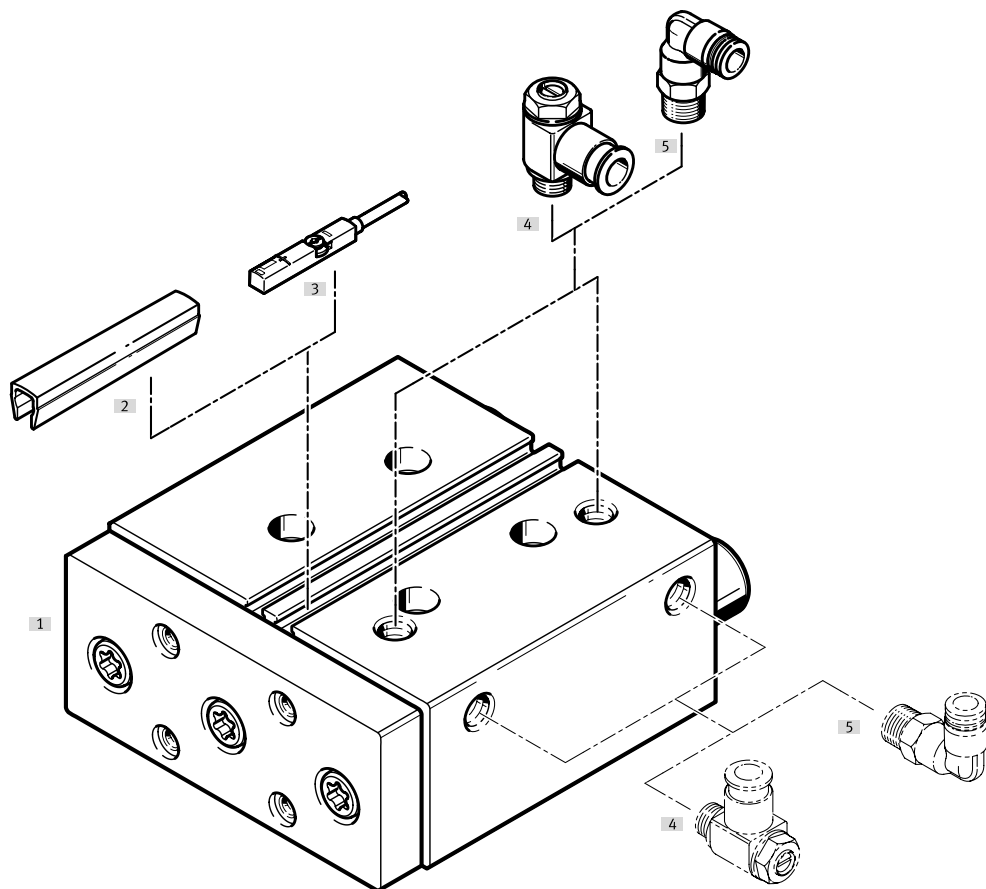

Accessories		Description	→ Page/Internet
[1]	Guided drive DFM	Guided drive, basic version	9
[2]	Slot cover ABP-5-S	For protecting the sensor cables and the sensor slots from contamination	77
[3]	Proximity switch SME-/SMT-8	Can be integrated in the profile barrel	76
[4]	One-way flow control valve GRLA	For regulating speed	77
[5]	Push-in fitting QSM/QS	For connecting tubing with standard O.D.	qs
-	Centring sleeves ZBH	4 or 6 included in the scope of delivery	75
-	Adapter	For drive/drive connections	78
		For drive/gripper connections	gripper

Extremely functional

Direction of movement

High resistance to torsion, torque and transverse force absorption

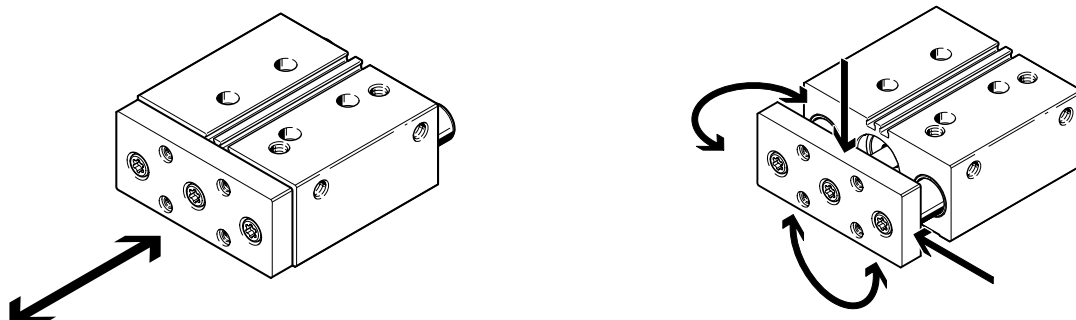

Datasheet

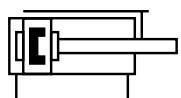

 www.festo.com Piston-Ø
12 ... 100 mm

 Repair service
Piston-Ø 12 ... 100 mm

- Ø - Diameter
6 ... 100 mm

- | - Stroke length
5 ... 200 mm

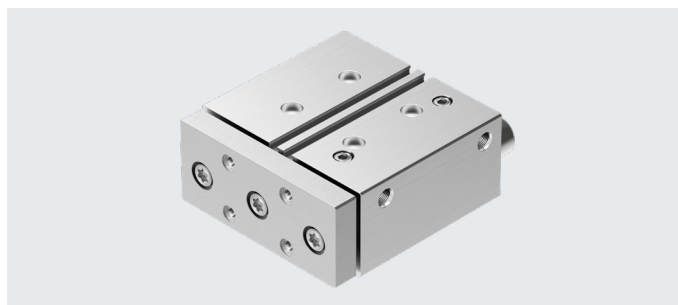

General technical data												
Piston Ø	6	10	12	16	20	25	32	40	50	63	80	100
Pneumatic connection	M3	M3	M5	M5	M5	G1/8	G1/8	G1/8	G1/4	G1/4	G3/8	G3/8
Design	Piston											
	Piston rod											
	Guide rods with yoke											
Cushioning	Elastic cushioning rings/plates at both ends											
Position sensing	Via proximity switch											
Type of mounting	Via through-hole											
	With female thread											
Mounting position	Any											
Protection against rotation/guide	Guide rods with yoke/plain-bearing or ball bearing guide											

Operating and environmental conditions												
Piston Ø	6	10	12	16	20	25	32	40	50	63	80	100
Operating pressure												
	[MPa]	0.2 ... 0.8	0.15 ... 0.8	0.2 ... 1		0.15 ... 1			0.1 ... 1		0.05 ... 1	
	[bar]	2 ... 8	1.5 ... 8	2 ... 10		1.5 ... 10			1 ... 10		0.5 ... 10	
Operating medium	Compressed air to ISO 8573-1:2010 [7:4:4]											
Note on the operating/pilot medium	Lubricated operation possible (in which case lubricated operation will always be required)											
Ambient temperature ¹⁾												
DFM-...-GF	[°C]	-10 ... +60		-20 ... +80								
DFM-...-KF	[°C]	-		-5 ... +60								
Corrosion resistance class CRC ²⁾	1 - Low corrosion stress											
Cleanroom class	7 according to ISO 14644-1									-		
ATEX	Selected types → www.festo.com											

1) Note operating range of proximity switches
2) More information: www.festo.com/x/topic/crc

Speeds [m/s]												
Piston Ø	6	10	12	16	20	25	32	40	50	63	80	100
Cushioning P												
Maximum speed advancing	1.3	1.7	0.8	0.8	0.8	0.8	0.8	0.8	0.6	0.6	0.4	0.4
Maximum speed retracting	1.1	1.6	0.8	0.8	0.8	0.8	0.8	0.8	0.6	0.6	0.4	0.4

Datasheet

Forces [N]												
Piston ø	6	10	12	16	20	25	32	40	50	63	80	100
Theoretical force at 0.6 MPa (6 bar, 87 psi), advancing	17	47	68	121	188	295	482	754	1178	1870	3016	4712
Theoretical force at 0.6 MPa (6 bar, 87 psi), retracting	13	40	51	90	141	247	415	686	1057	1750	2827	4418

Impact energy [J]												
Piston ø	6	10	12	16	20	25	32	40	50	63	80	100
Max. impact energy in the end positions	0.012	0.035	0.07	0.15	0.20	0.30	0.40	0.70	1.00	1.30	0.75	1.00

Permissible impact velocity:

$$v = \sqrt{\frac{2 \cdot E}{m_1 + m_2}}$$

v permissible impact speed
 E max. impact energy
 m₁ moving mass (drive)
 m₂ moving payload

Maximum permissible mass:

$$m_2 = \frac{2 \cdot E}{v^2} - m_1$$

 **Note**
 These specifications represent the maximum values that can be achieved. The maximum permissible impact energy must be observed.

DFM with plain-bearing guide GF													
Stroke [mm]	Piston ø	6	10	12	16	20	25	32	40	50	63	80	100
Product weight [g]													
5	28	38	–	–	–	–	–	–	–	–	–	–	–
10	33	45.5	344	444	–	–	–	–	–	–	–	–	–
15	39.5	53.5	–	–	–	–	–	–	–	–	–	–	–
20	45	60.5	392	507	769	1256	1793	–	–	–	–	–	–
25	–	–	411	534	806	1308	1858	2217	3440	4470	6984	11000	–
30	–	–	435	565	850	1368	1937	–	–	–	–	–	–
40	–	–	497	710	1070	1515	2095	–	–	–	–	–	–
50	–	–	544	772	1158	1635	2254	2655	4085	5243	8185	12589	–
80	–	–	688	960	1422	1993	2808	3261	5013	6287	9743	14699	–
100	–	–	779	1081	1592	2225	3111	3595	5511	6904	10482	15760	–
125	–	–	–	–	–	–	3595	4123	6302	7824	11490	17094	–
160	–	–	–	–	–	–	4149	4736	7205	8906	12910	18980	–
200	–	–	–	–	–	–	4781	5437	8238	10142	14363	21148	–
Moving mass [g]													
5	8	13	–	–	–	–	–	–	–	–	–	–	–
10	9	16	172	221	–	–	–	–	–	–	–	–	–
15	11.5	18.5	–	–	–	–	–	–	–	–	–	–	–
20	13	21	186	242	385	650	1020	–	–	–	–	–	–
25	–	–	193	253	400	669	1049	1228	2026	2471	4141	6301	–
30	–	–	200	264	415	687	1077	–	–	–	–	–	–
40	–	–	232	343	552	755	1134	–	–	–	–	–	–
50	–	–	246	364	582	793	1191	1371	2254	2699	4717	7113	–
80	–	–	289	428	672	904	1450	1629	2687	3130	5461	8141	–
100	–	–	318	471	732	979	1564	1743	2870	3313	5734	8523	–
125	–	–	–	–	–	–	1803	1983	3249	3692	6076	9000	–
160	–	–	–	–	–	–	2003	2183	3569	4010	6553	9668	–
200	–	–	–	–	–	–	2232	2411	3935	4375	7099	10431	–

Datasheet

DFM with recirculating ball bearing guide KF										
Stroke [mm]	Piston ø									
	12	16	20	25	32	40	50	63	80	100
Product weight [g] (for calculation → page 24)										
10	314	426	–	–	–	–	–	–	–	–
20	357	484	747	1173	1627	–	–	–	–	–
25	375	508	781	1221	1684	2043	3212	4242	6506	10520
30	397	537	822	1278	1755	–	–	–	–	–
40	480	641	981	1411	1896	–	–	–	–	–
50	524	699	1064	1524	2038	2439	3801	4959	7582	11980
80	655	872	1310	1863	2511	2964	4614	5888	8895	13612
100	737	982	1468	2080	2781	3265	5068	6461	9500	14587
125	–	–	–	–	3189	3717	5758	7279	10485	15820
160	–	–	–	–	3684	4271	6583	8283	11750	17545
200	–	–	–	–	4249	4905	7525	9429	13214	21124
Moving mass [g] (for calculation → page 24)										
10	155	212	–	–	–	–	–	–	–	–
20	165	229	376	595	875	–	–	–	–	–
25	170	241	388	611	895	1074	1796	2241	3673	5696
30	175	249	400	626	915	–	–	–	–	–
40	196	294	488	680	955	–	–	–	–	–
50	206	310	512	711	996	1175	1969	2413	4092	6318
80	237	359	584	802	1173	1352	2287	2731	4632	7105
100	257	392	632	863	1254	1433	2425	2868	4837	7406
125	–	–	–	–	1418	1597	2703	3146	5093	7782
160	–	–	–	–	1559	1738	2945	3386	5451	8308
200	–	–	–	–	1720	1899	3221	3660	5861	8910

DFM with recirculating ball bearing guide KF										
Stroke [mm]	Piston ø									
	12	16	20	25	32	40	50	63	80	100
Centre of gravity of the moving mass [mm] (for calculation → page 24)										
10	13.6	13.4	–	–	–	–	–	–	–	–
20	15.2	16.5	17.5	24.6	26.3	–	–	–	–	–
25	16.7	19.1	19.1	26.4	28.0	28.2	30.6	27.8	33.9	35.0
30	18.3	20.8	20.8	28.2	29.8	–	–	–	–	–
40	25.3	31.2	34.6	34.9	33.4	–	–	–	–	–
50	29.0	35.2	38.5	38.8	37.1	37.3	39.5	35.8	47.2	48.3
80	40.6	47.8	50.9	50.9	54.7	53.9	57.4	51.9	66.8	67.9
100	48.8	56.5	59.4	59.4	63.0	62.1	65.6	59.4	74.1	75.2
125	–	–	–	–	80.9	79.0	82.8	75.2	84.1	85.2
160	–	–	–	–	96.4	94.4	98.1	89.6	98.4	99.5
200	–	–	–	–	114.6	112.3	115.9	106.5	115.2	116.3

Materials		
Guided drive		
Piston ø	6, 10	12 ... 100
Yoke plate	Aluminium	Quenched and tempered steel
Housing	Anodised wrought aluminium alloy	
Piston rod	High-alloy stainless steel	
Guide rods		
DFM-...-GF	High-alloy stainless steel	
DFM-...-KF	Quenched and tempered steel, hard-chrome plated	
Static seals	Nitrile rubber	
Dynamic seals	Polyurethane, HNBR	Polyurethane
Note on materials	RoHS-compliant	
LABS (PWIS) conformity	VDMA24364-B1/B2-L	
DFM-...-F1A	Metals with copper, zinc or nickel as the main constituent are excluded from use. Exceptions are nickel in steel, chemically nickel-plated surfaces, printed circuit boards, cables, electrical plug connectors and coils.	

Datasheet

Maximum payload F [N]

Plain-bearing guide GF and recirculating ball bearing guide KF

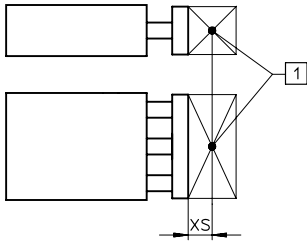

[1] Centre of gravity of payload

Piston \varnothing	6	10	12	16	20	25	32	40	50	63	80	100
XS [mm]	5	5	25	50	50	50	50	50	50	50	125	125

Stroke [mm]		Piston \varnothing											
		6	10	12	16	20	25	32	40	50	63	80	100
5	GF	1.1	3.7	–	–	–	–	–	–	–	–	–	–
	KF	–	–	38	45	–	–	–	–	–	–	–	–
10	GF	0.85	3.0	29	30	–	–	–	–	–	–	–	–
	KF	–	–	38	45	–	–	–	–	–	–	–	–
15	GF	0.7	2.5	–	–	–	–	–	–	–	–	–	–
	KF	–	–	33	41	46	110	155	–	–	–	–	–
20	GF	0.6	2.1	25	27	30	121	188	–	–	–	–	–
	KF	–	–	33	41	46	110	155	–	–	–	–	–
25	GF	–	–	23	25	28	116	180	180	257	257	276	452
	KF	–	–	31	39	44	105	149	149	235	235	220	332
30	GF	–	–	22	24	27	112	173	–	–	–	–	–
	KF	–	–	29	37	42	102	144	–	–	–	–	–
40	GF	–	–	31	73	110	123	161	–	–	–	–	–
	KF	–	–	35	82	108	119	135	–	–	–	–	–
50	GF	–	–	28	67	103	115	150	150	216	216	311	509
	KF	–	–	32	77	102	112	126	126	202	202	275	415
80	GF	–	–	22	55	86	96	166	166	234	234	352	568
	KF	–	–	25	64	86	95	151	151	233	233	329	495
100	GF	–	–	19	49	77	86	150	150	212	212	329	533
	KF	–	–	22	58	78	86	138	138	214	214	318	480
125	GF	–	–	–	–	–	–	168	168	229	229	304	494
	KF	–	–	–	–	–	–	161	161	238	238	306	463
160	GF	–	–	–	–	–	–	146	146	200	200	274	446
	KF	–	–	–	–	–	–	143	143	212	212	291	442
200	GF	–	–	–	–	–	–	127	127	174	174	245	400
	KF	–	–	–	–	–	–	127	127	189	189	277	422

 **Note**

For calculating eccentric load cases for DFM-...-KF → Page 20

Datasheet

Permissible torque load M [Nm]

Plain-bearing guide GF and recirculating ball bearing guide KF

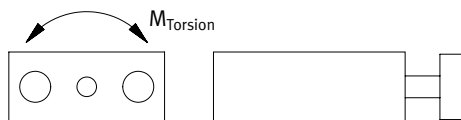

Stroke [mm]		Piston ø											
		6	10	12	16	20	25	32	40	50	63	80	100
5	GF	0.011	0.057	–	–	–	–	–	–	–	–	–	–
10	GF	0.008	0.046	0.92	1.44	–	–	–	–	–	–	–	–
	KF	–	–	1.21	2.19	–	–	–	–	–	–	–	–
15	GF	0.007	0.039	–	–	–	–	–	–	–	–	–	–
20	GF	0.006	0.034	0.75	1.17	1.61	6.27	10.66	–	–	–	–	–
	KF	–	–	0.98	1.79	2.43	6.14	9.62	–	–	–	–	–
25	GF	–	–	0.68	1.07	1.47	5.90	10.06	11.30	19.40	21.81	41.01	76.99
	KF	–	–	0.90	1.64	2.24	5.77	9.08	10.25	19.35	21.98	34.06	60.83
30	GF	–	–	0.63	0.98	1.36	5.57	9.53	–	–	–	–	–
	KF	–	–	0.82	1.52	2.08	5.43	8.60	–	–	–	–	–
40	GF	–	–	0.81	2.44	4.21	5.76	8.60	–	–	–	–	–
	KF	–	–	0.93	2.92	4.64	5.94	7.77	–	–	–	–	–
50	GF	–	–	0.73	2.20	3.85	5.26	7.83	8.78	15.44	17.30	40.09	76.16
	KF	–	–	0.83	2.63	4.23	5.43	7.09	8.00	15.51	17.62	35.04	63.12
80	GF	–	–	0.55	1.69	3.04	4.17	8.01	8.98	15.60	17.48	40.34	76.75
	KF	–	–	0.62	2.03	3.36	4.33	7.71	8.70	16.43	18.67	36.64	65.84
100	GF	–	–	0.47	1.46	2.66	3.64	7.08	7.94	13.89	15.54	36.70	70.12
	KF	–	–	0.53	1.77	2.95	3.81	6.86	7.74	14.76	16.77	33.30	60.05
125	GF	–	–	–	–	–	–	7.65	8.57	14.47	16.19	32.90	63.14
	KF	–	–	–	–	–	–	7.66	8.64	15.77	17.92	29.83	53.98
160	GF	–	–	–	–	–	–	6.54	7.32	12.43	13.87	28.59	55.17
	KF	–	–	–	–	–	–	6.64	7.49	13.78	15.66	25.91	47.08
200	GF	–	–	–	–	–	–	5.57	6.23	10.62	11.81	24.68	47.91
	KF	–	–	–	–	–	–	5.76	6.50	12.04	13.68	22.39	40.82

Note

Engineering tool

→ www.festo.com/engineeringtools

Note

For calculating eccentric load cases for

DFM-...-KF → Page 20

Datasheet

Torsional backlash ρ

Plain-bearing guide GF and recirculating ball bearing guide KF in retracted state, unloaded

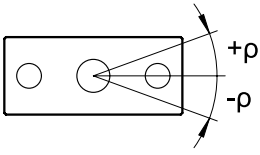

Piston \varnothing		6	10	12	16	20	25	32	40	50	63	80	100
Average torsional backlash [°]	GF	±0.1	±0.1	±0.06	±0.06	±0.05	±0.04	±0.04	±0.03	±0.03	±0.02	±0.03	±0.03
Torsional backlash [°]	KF	–	–	±0.03	±0.02	±0.02	±0.02	±0.01	±0.01	±0.02	±0.02	±0.03	±0.03

Deflection of the end plate

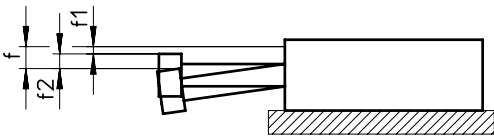

$$f = f_1 + f_2$$

f = total deflection of the end plate

f_1 = deflection due to average bearing clearance (GF)/bearing clearance (KF)

Bearing clearance GF with production tolerance ± 0.01 mm

Bearing clearance KF determined through series of tests

f_2 = deflection due to transverse force

Deflection f_1 due to bearing clearance as a function of stroke l (with no load)

1 bearing per guide rod

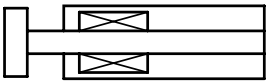

GF: DFM-6/10 all strokes
 DFM-16/20 stroke ≤ 30 mm
 KF: DFM-12/16/20 Stroke ≤ 30 mm

2 bearing per guide rod

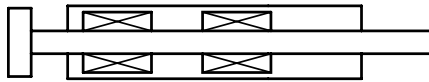

GF: DFM-12 Stroke ≤ 30 mm
 GF+KF: DFM-12/16/20 Stroke ≥ 40 mm
 DFM-25 ... 100 All strokes

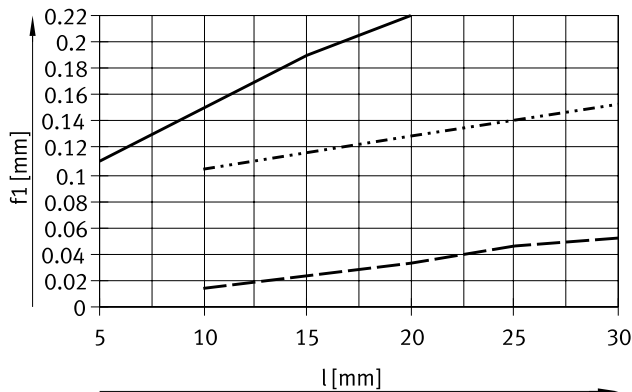

— Plain-bearing guide GF (average deflection f_1) for $\varnothing 6/10$
 Plain-bearing guide GF (average deflection f_1) for $\varnothing 12 \dots 100$
 - - - Recirculating ball bearing guide KF

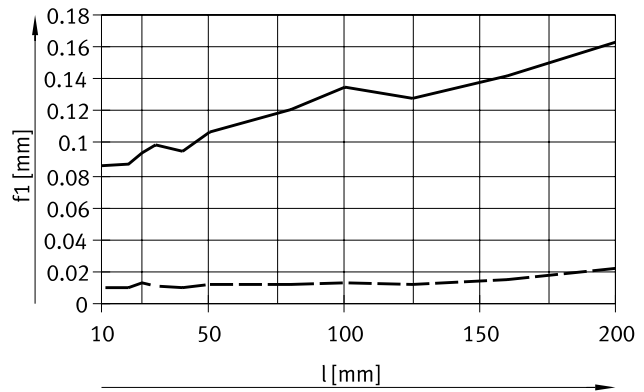

— Plain-bearing guide GF (average deflection f_1)
 Recirculating ball bearing guide KF

Datasheet

Use as stopper cylinder

When used as a stopper cylinder, only guided drives with plain-bearing guide DFM-...-GF may be used.

In addition, the distance l_{max} (→ drawing) must not be exceeded.

The permissible kinetic impact energy at the end stop must also not be exceeded.

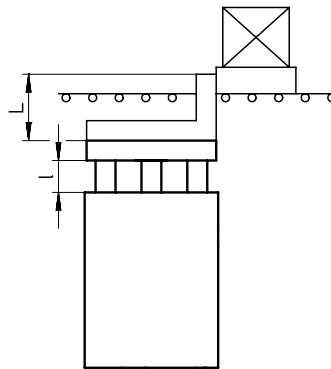

$l_{max*} = \text{stroke } l + \text{height of stop bracket } L$
 $l_{max*} = 50 \text{ mm}$

Impact mass m as a function of impact velocity v

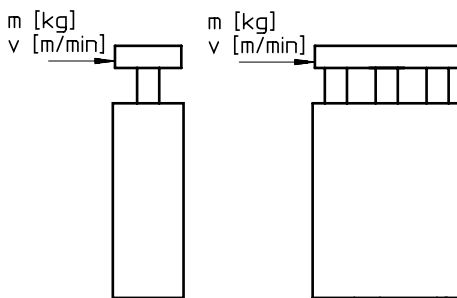

DFM-12 ... 25-GF, stroke < 30 mm

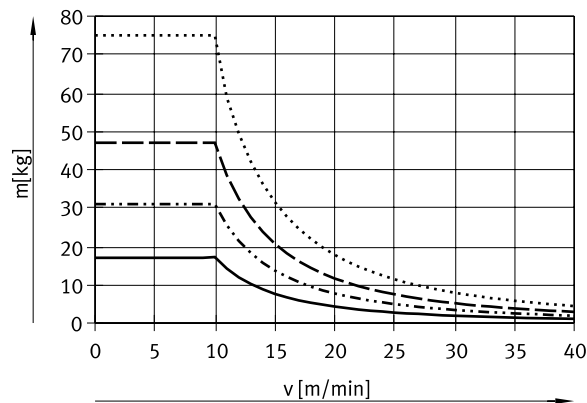

- DFM-12
- DFM-16
- - - DFM-20
- DFM-25

The values in the above graph are based on the assumption that the workpiece carrier is fitted with an elastic buffer with deformation of 1 mm. Only guided drives with a plain-bearing guide GF < 30 mm stroke may be used.

DFM-32 ... 100-GF, stroke < 50 mm

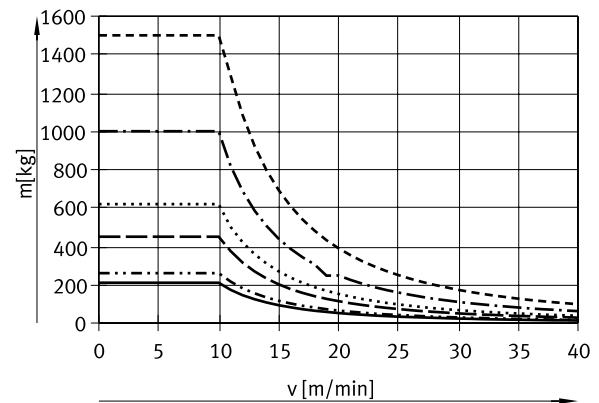

- DFM-32
- DFM-40
- - - DFM-50
- DFM-63
- · - · - DFM-80
- DFM-100

The values in the above graph are based on the assumption that the workpiece carrier is fitted with an elastic buffer with deformation of 2 mm. Only guided drives with a plain-bearing guide GF < 50 mm stroke may be used.

Datasheet

Use as a lifting cylinder

Permissible load with plain-bearing guide GF

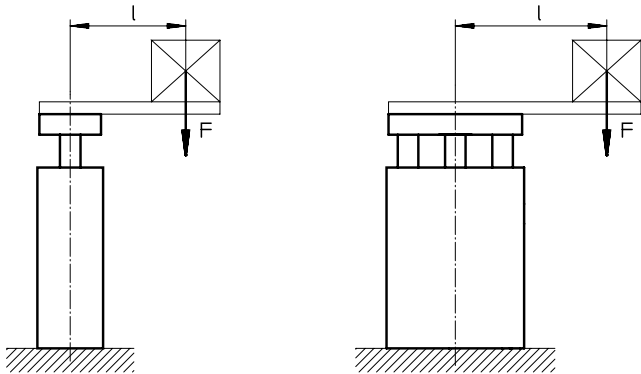

Permissible eccentric load at 0.6 MPa (6 bar, 87 psi):

Piston ø	12	16	20	25	32	40	50	63	80	100	
Load	[N]	27	48	85	133	241	415	648	935	1508	2356

Permissible eccentric load at different pressure:

Piston ø	12	16	20	25	32	63	80	100	40	50
Load	[%]	≤ 40 ¹⁾		≤ 45 ¹⁾		≤ 50 ¹⁾		≤ 55 ¹⁾		

1) The theoretical longitudinal force at the corresponding pressure

F = longitudinal force [N]

l = lever arm [mm]

DFM-12 ... 25-GF, stroke up to 30 mm

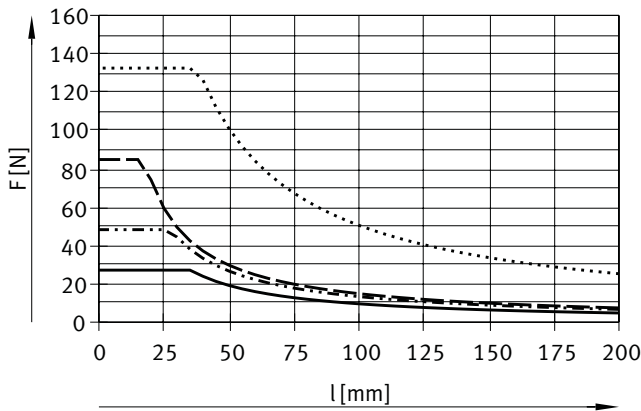

- DFM-12
- DFM-16
- - - DFM-20
- · - · DFM-25

DFM-12 ... 25-GF, stroke 40 ... 100 mm

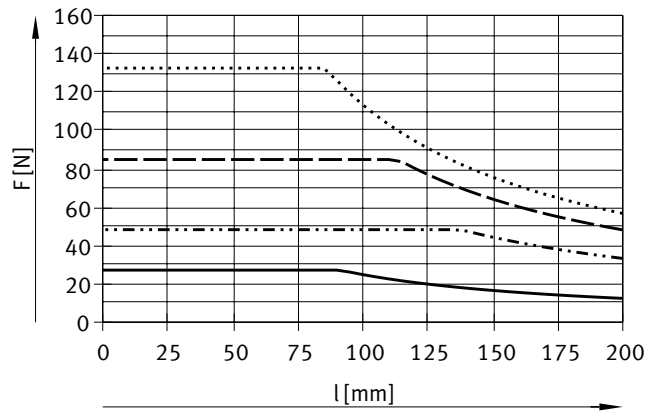

- DFM-12
- DFM-16
- - - DFM-20
- · - · DFM-25

DFM-32 ... 63-GF, stroke up to 50 mm

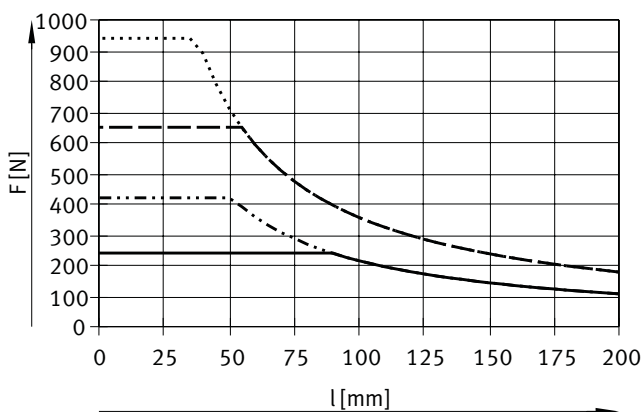

- DFM-32
- DFM-40
- - - DFM-50
- · - · DFM-63

DFM-32 ... 63-GF, stroke 80 ... 100 mm

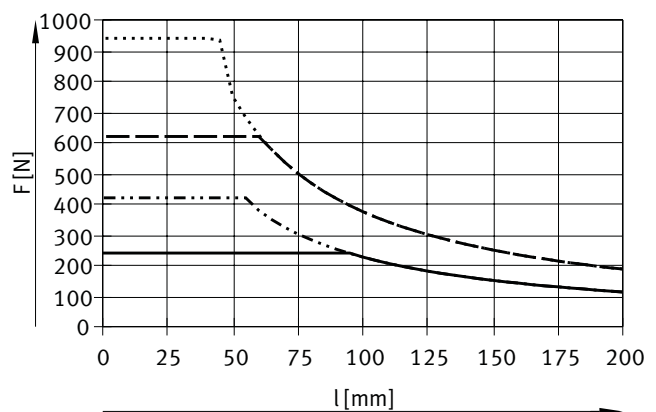

- DFM-32
- DFM-40
- - - DFM-50
- · - · DFM-63

Datasheet

Use as a lifting cylinder

Permissible load with plain-bearing guide GF

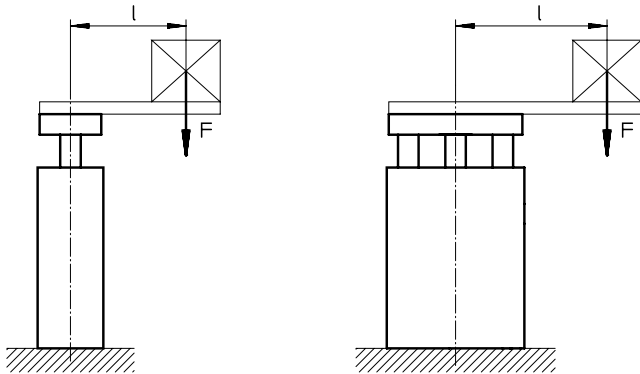

Permissible eccentric load at 0.6 MPa (6 bar, 87 psi):

Piston ø	12	16	20	25	32	40	50	63	80	100	
Load	[N]	27	48	85	133	241	415	648	935	1508	2356

Permissible eccentric load at different pressure:

Piston ø	12	16	20	25	32	63	80	100	40	50
Load	[%]	≤ 40 ¹⁾		≤ 45 ¹⁾		≤ 50 ¹⁾		≤ 55 ¹⁾		

1) The theoretical longitudinal force at the corresponding pressure

F = longitudinal force [N]

l = lever arm [mm]

DFM-32 ... 63-GF, stroke 125 ... 200 mm

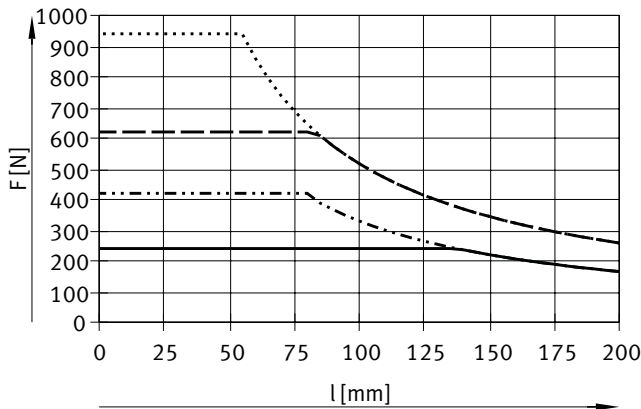

- DFM-32
- DFM-40
- - - DFM-50
- · - · DFM-63

DFM-80 ... 100-GF, stroke 25 mm

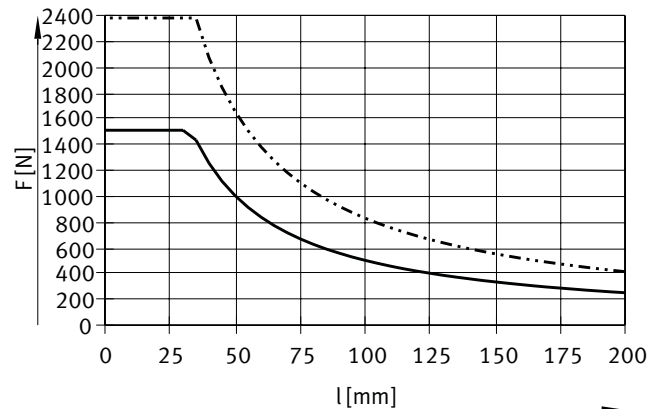

- DFM-80
- DFM-100

DFM-80 ... 100-GF, stroke 50 mm

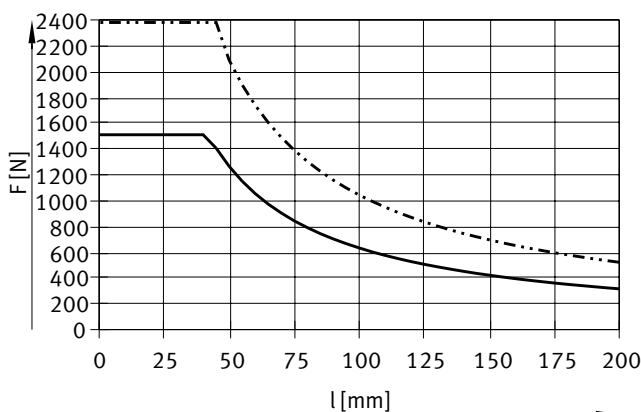

- DFM-80
- DFM-100

DFM-80 ... 100-GF, stroke 80 ... 200 mm

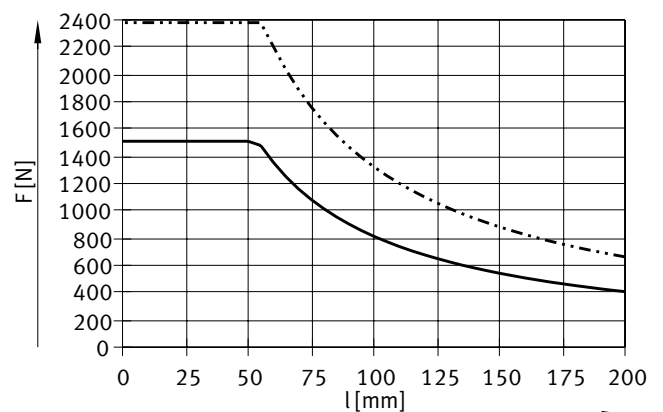

- DFM-80
- DFM-100

Datasheet

Use as a lifting cylinder

Permissible load with recirculating ball bearing guide KF

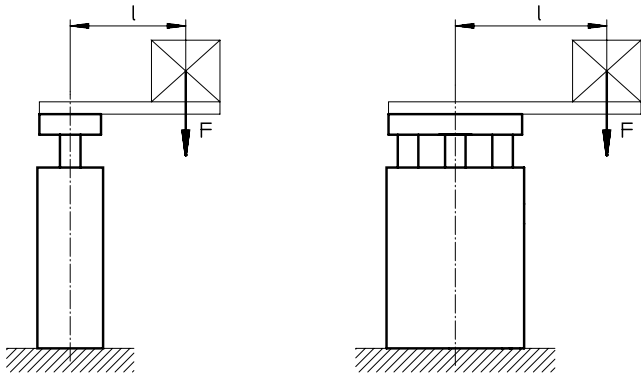

Permissible eccentric load at 0.6 MPa (6 bar, 87 psi):

Piston ø	12	16	20	25	32	40	50	63	80	100	
Load	[N]	27	48	85	133	241	415	648	935	1508	2356

Permissible eccentric load at different pressure:

Piston ø	12	16	20	25	32	63	80	100	40	50
Load	[%]	≤ 40 ¹⁾		≤ 45 ¹⁾		≤ 50 ¹⁾		≤ 55 ¹⁾		

1) The theoretical longitudinal force at the corresponding pressure

F = longitudinal force [N]

l = lever arm [mm]

DFM-12 ... 25-KF, stroke up to 30 mm

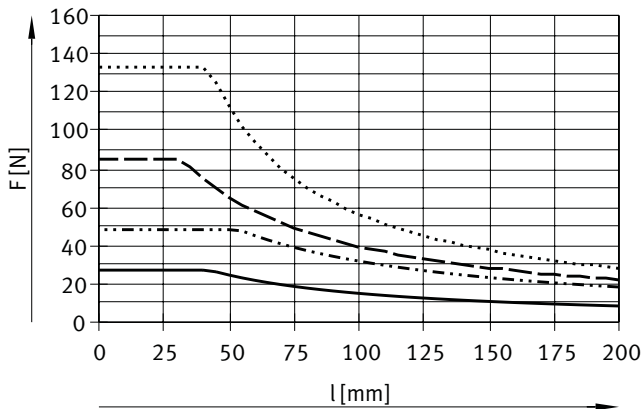

- DFM-12
- DFM-16
- - - DFM-20
- · - · DFM-25

DFM-12 ... 25-KF, stroke 40 ... 100 mm

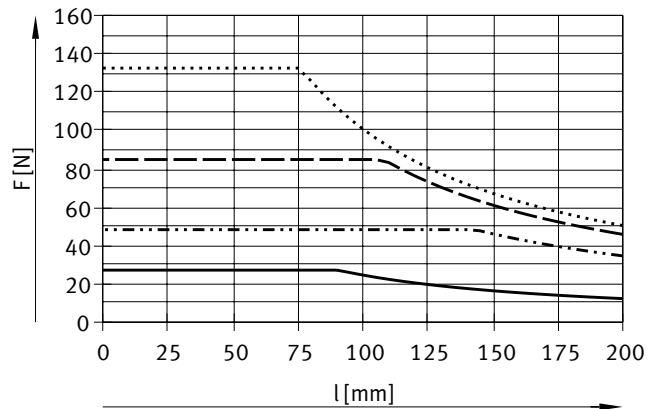

- DFM-12
- DFM-16
- - - DFM-20
- · - · DFM-25

DFM-32 ... 63-KF, stroke up to 50 mm

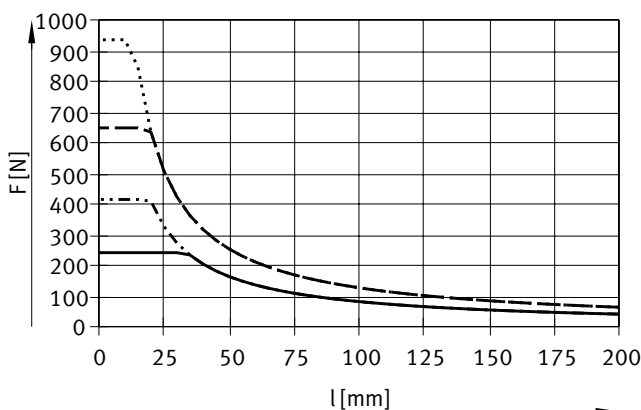

- DFM-32
- DFM-40
- - - DFM-50
- · - · DFM-63

DFM-32 ... 63-KF, stroke 80 ... 100 mm

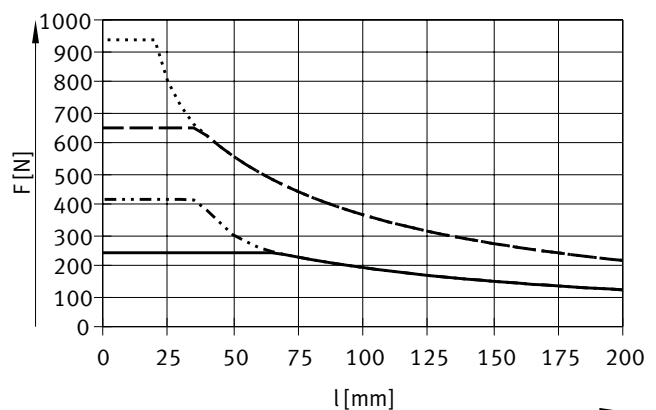

- DFM-32
- DFM-40
- - - DFM-50
- · - · DFM-63

Datasheet

Use as a lifting cylinder

Permissible load with recirculating ball bearing guide KF

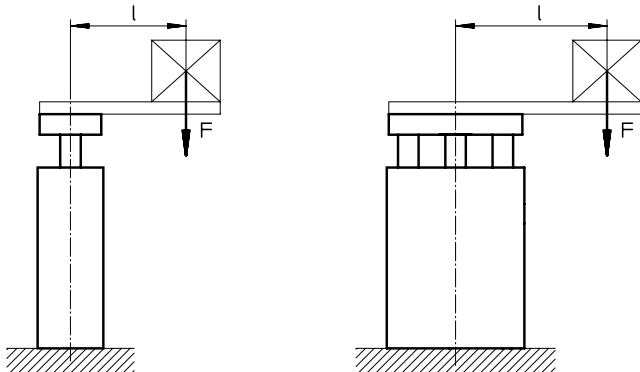

Permissible eccentric load at 0.6 MPa (6 bar, 87 psi):

Piston ø	12	16	20	25	32	40	50	63	80	100	
Load	[N]	27	48	85	133	241	415	648	935	1508	2356

Permissible eccentric load at different pressure:

Piston ø	12	16	20	25	32	63	80	100	40	50
Load	[%]	≤ 40 ¹⁾		≤ 45 ¹⁾		≤ 50 ¹⁾		≤ 55 ¹⁾		

1) The theoretical longitudinal force at the corresponding pressure

F = longitudinal force [N]

l = lever arm [mm]

DFM-32 ... 63-KF, stroke 125 ... 200 mm

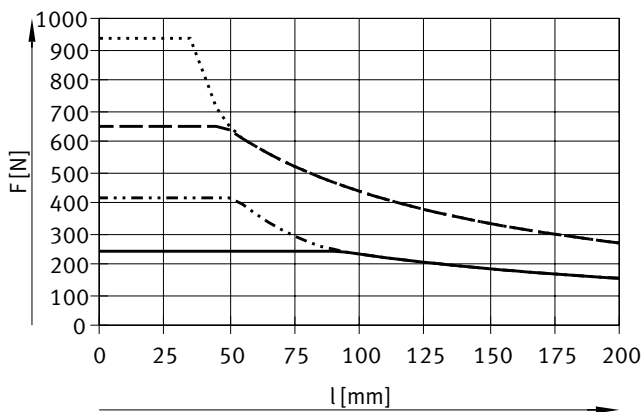

— DFM-32
 DFM-40
 - - - DFM-50
 - · - · DFM-63

DFM-80 ... 100-KF, stroke 25 mm

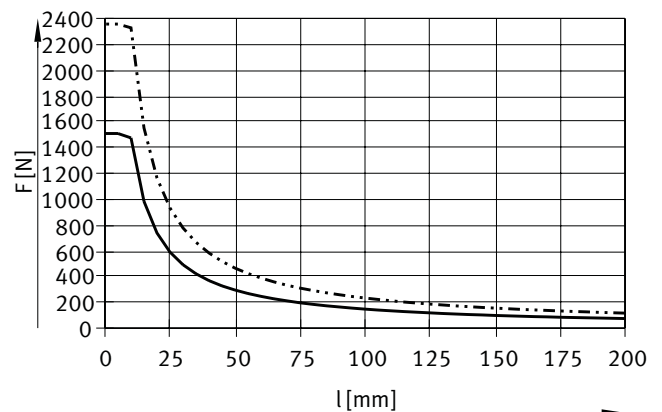

— DFM-80
 DFM-100

DFM-80 ... 100-KF, stroke 50 mm

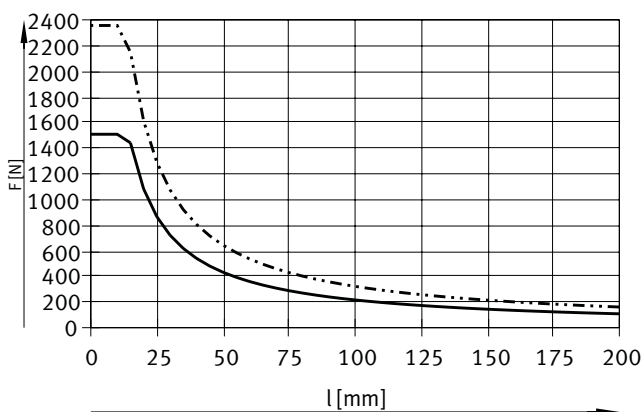

— DFM-80
 DFM-100

DFM-80 ... 100-KF, stroke 80 ... 200 mm

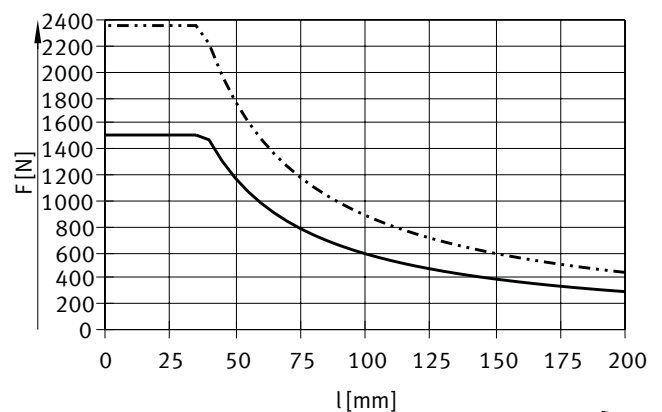

— DFM-80
 DFM-100

Datasheet

Load values

The indicated forces and torques refer to the centre of the guide.

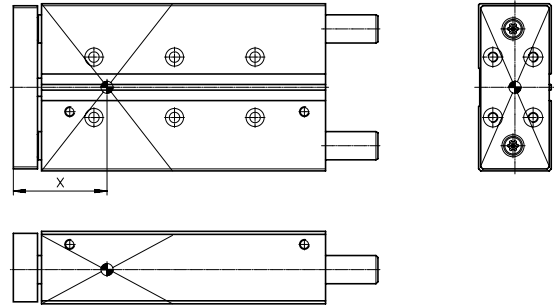
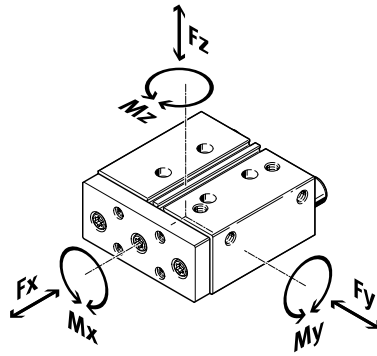

If several of the forces and torques listed below act simultaneously on the guided drive, the following equation must be fulfilled in addition to the maximum loads listed:

Calculating the load comparison factor:

$$f_v = \frac{|F_{y1}|}{F_{y2}} + \frac{|F_{z1}|}{F_{z2}} + \frac{|M_{x1}|}{M_{x2}} + \frac{|M_{y1}|}{M_{y2}} + \frac{|M_{z1}|}{M_{z2}} \leq 1$$

Datasheet

Distance X (for calculation → page 24)

Piston ø	Stroke [mm]	Dimension X [mm]	Piston ø	Stroke [mm]	Dimension X [mm]
12	10 ... 30	26.1	40	25 ... 50	47.5
	40 ... 100	35.3		80 ... 100	56.5
				125 ... 200	66.5
16	10 ... 30	25.5	50	25 ... 50	54.5
	40 ... 100	38.5		80 ... 100	65
				125 ... 200	75
20	20 ... 30	28.5	63	25 ... 50	54.5
	40 ... 100	46.5		80 ... 100	65
				125 ... 200	75
25	20 ... 30	42.5	80	25	66.5
	40 ... 100	47.5		50	77
				80 ... 200	92
32	20 ... 50	47.5	100	25	73
	80 ... 100	56.5		50	84
	125 ... 200	66.5		80 ... 200	99

Datasheet

Max. permissible forces and torques for plain-bearing guide GF

The indicated forces and torques refer to the centre of the guide.

Piston \varnothing	Stroke [mm]	Static/dynamic (for a service life of 10,000 km)		
		$F_{y_{max.}}/F_{z_{max.}}$ [N]	$M_{x_{max.}}$ [Nm]	$M_{y_{max.}}/M_{z_{max.}}$ [Nm]
12	10 ... 30	240	4.92	2.06
	40 ... 100	240	4.92	3.74
16	10 ... 30	304	6.99	2.89
	40 ... 100	608	13.98	10.34
20	20 ... 30	354.7	10.29	3.37
	40 ... 100	709.3	20.57	16.31
25	20 ... 30	810.7	27.56	15.4
	40 ... 100	810.7	27.56	19.46
32	20 ... 50	1227	47.84	24.53
	80 ... 100	1227	47.84	35.57
	125 ... 200	1227	47.84	47.84
40	25 ... 50	1227	53.97	24.53
	80 ... 100	1227	53.97	35.57
	125 ... 200	1227	53.97	47.84
50	25 ... 50	1533	84.33	38.33
	80 ... 100	1533	84.33	54.43
	125 ... 200	1533	84.33	69.77
63	25 ... 50	1533	95.83	38.33
	80 ... 100	1533	95.83	54.43
	125 ... 200	1533	95.83	69.77
80	25	2320	179.8	67.28
	50	2320	179.8	91.64
	80 ... 200	2320	179.8	126.4
100	25	3640	342.2	111
	50	3640	342.2	151.1
	80 ... 200	3640	342.2	205.7

 **Note**

For calculating loads attached to the centre of the end plate and centrally acting moments → Page 12/13

Datasheet

Max. permissible forces and torques for recirculating ball bearing guide KF

The indicated forces and torques refer to the centre of the guide.

Piston \varnothing	Stroke [mm]	Static			Dynamic (for a service life of 10000 km)		
		$F_{y_{max.}}/F_{z_{max.}}$ [N]	$M_{x_{max.}}$ [Nm]	$M_{y_{max.}}/M_{z_{max.}}$ [Nm]	$F_{y_{max.}}/F_{z_{max.}}$ [N]	$M_{x_{max.}}$ [Nm]	$M_{y_{max.}}/M_{z_{max.}}$ [Nm]
12	10 ... 30	355	7.28	3.2	270	5.53	2.43
	40 ... 100	343	7.04	3.26	375	7.68	3.56
16	10 ... 30	415	9.55	4.15	389	8.95	3.89
	40 ... 100	830	19.09	11.2	778	17.9	10.5
20	20 ... 30	510	14.79	5.61	408	11.84	4.49
	40 ... 100	1020	29.58	18.87	817	23.69	15.11
25	20 ... 30	1060	36.04	15.37	863	29.35	12.52
	40 ... 100	1060	36.04	20.67	863	29.35	16.83
32	20 ... 50	1260	49.14	20.79	1130	44.09	18.66
	80 ... 100	1260	49.14	32.13	1130	44.09	28.83
	125 ... 200	1260	49.14	44.73	1130	44.09	40.13
40	25 ... 50	1260	55.44	20.79	1130	49.74	18.66
	80 ... 100	1260	55.44	32.13	1130	49.74	28.83
	125 ... 200	1260	55.44	44.73	1130	49.74	40.13
50	25 ... 50	1600	88	34.4	1487	81.79	31.98
	80 ... 100	1600	88	51.2	1487	81.79	47.58
	125 ... 200	1600	88	67.2	1487	81.79	62.46
63	25 ... 50	1600	100	34.4	1487	92.97	31.98
	80 ... 100	1600	100	51.2	1487	92.97	47.58
	125 ... 200	1600	100	67.2	1487	92.97	62.46
80	25	3120	241.8	73.32	2048	158.67	48.12
	50	3120	241.8	106.1	2048	158.67	69.62
	80 ... 200	3120	241.8	152.9	2048	158.67	100.35
100	25	5400	507.6	135	3043	286.02	76.06
	50	5400	507.6	194.4	3043	286.02	109.53
	80 ... 200	5400	507.6	275.4	3043	286.02	155.16

 **Note**

For calculating loads attached to the centre of the end plate and centrally acting moments → Page 12/13

Datasheet

Calculating the service life for recirculating ball bearing guide KF

The service life of the guide depends on the load. To provide a rough indication of the service life of the guide, the graph below plots the load comparison factor f_v against the service life ratio q .

These values are only theoretical. You must consult your local contact person at Festo for load comparison factors f_v greater than 1.5.

Load comparison factor f_v as a function of service life ratio q

Example: The effect on the service life, deviating from the specified reference service life, can be determined by the service life ratio q :

Assuming:

Reference service life = 10000 km

Required service life = 3000 km

$$q = \frac{3000 \text{ km}}{10,000 \text{ km}} = 0.3$$

The graph gives a load comparison factor f_v of 1.5. This means that the permissible total load can be utilised up to 150%.

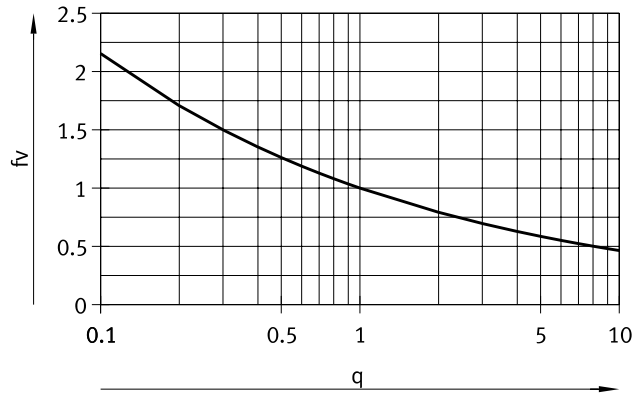

Note
Engineering tool
→ www.festo.com/engineeringtools

$f_v > 1.5$ are only theoretical comparative values.

Calculation example

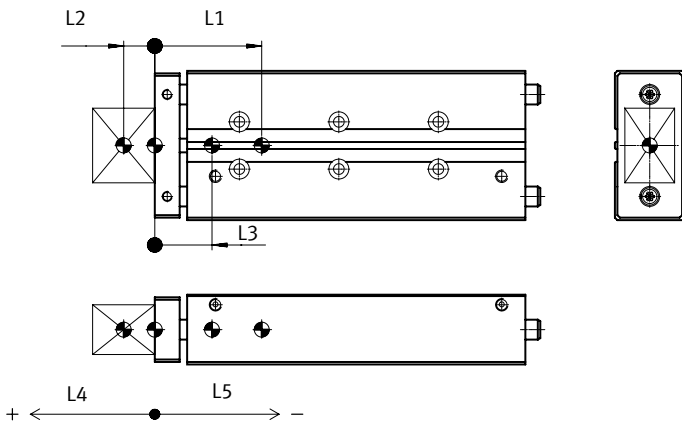

- L1 = centre of gravity of the moving mass of the guided drive
- L2 = centre of gravity of payload
- L3 = centre of gravity of the entire moving mass

Length measurements should be provided with plus/minus signs as shown in the figure:

- L3 > 0 = centre of gravity of the moving mass is on the payload side
- L3 < 0 = centre of gravity of the moving mass is on the guide side
- L4 = load side
- L5 = guide side

Assuming:

- Guided drives: DFM-32-80-KF
- Stroke length: $H = 80 \text{ mm}$
- Centre of gravity of payload: $L_{\text{Load}} = 35 \text{ mm}$
- Payload: $m_{\text{Load}} = 10 \text{ kg}$
- Acceleration: $a_x = 2 \text{ m/s}^2$, $a_y = a_z = 0 \text{ m/s}^2$

To be determined:

- Loads $F_{y_{\text{dyn}}}/F_{z_{\text{dyn}}}$ and $M_{x_{\text{dyn}}}/M_{y_{\text{dyn}}}/M_{z_{\text{dyn}}}$
- Functional operation with combined load
- Expected service life

Datasheet

Calculation example

Solution:

Moving mass:

m_b = moving mass of guided drive

m_{Last} = payload

$$m_{b_total} = m_b + m_{Load}$$

From table → page 11

$$m_b = 1.173 \text{ kg}$$

$$m_{b_total} = 1.173 \text{ kg} + 10 \text{ kg} = 11.173 \text{ kg}$$

Centre of gravity of the moving mass

$$L_{b_ges} = \frac{L_1 \cdot m_1 + L_b \cdot m_b}{m_{b_ges}}$$

L_b = centre of gravity of the moving mass of the guided drive

m_b = moving mass of guided drive

L_{Last} = centre of gravity of payload

m_{Last} = payload

From table → page 11

$$L_b = 54.7 \text{ mm}$$

$$L_{b_ges} = \frac{(+35 \text{ mm}) \cdot 10 \text{ kg} + (-54,7 \text{ mm}) \cdot 1,173 \text{ kg}}{11,173 \text{ kg}} = 25,6 \text{ mm}$$

Length measurements should be provided with plus/minus signs as shown in the figure:

$L_{b_total} > 0$ = Centre of gravity of the moving mass is on the payload side

$L_{b_total} < 0$ = Centre of gravity of the moving mass is on the guide side

Loads F_{y_dyn}/F_{z_dyn} and $M_{x_dyn}/M_{y_dyn}/M_{z_dyn}$

$$F_{y_dyn} = m_{b_total} \times a_y = 11.173 \text{ kg} \times 0 \text{ m/s}^2 = 0 \text{ N}$$

$$F_{z_dyn} = m_{b_total} \times (g + a_z) = 11.173 \text{ kg} \times (9.81 \text{ m/s}^2 + 0 \text{ m/s}^2) = 110 \text{ N}$$

From table → page 20

Dimension X = 56.5 mm

$$M_{y_dyn} = F_{z_dyn} \times (\text{dimension X} + \text{stroke} + L_{b_total}) = 110 \text{ N} \times (56.5 \text{ mm} + 80 \text{ mm} + 25.6 \text{ mm}) = 17.8 \text{ Nm}$$

$$M_{z_dyn} = F_{y_dyn} \times (\text{dimension X} + \text{stroke} + L_{b_total}) = 0 \text{ N} \times (56.5 \text{ mm} + 80 \text{ mm} + 25.6 \text{ mm}) = 0 \text{ Nm}$$

Functional operation with combined load

Max. values from table → page 22

$$F_{y_max} = 1130 \text{ N}$$

$$F_{z_max} = 1130 \text{ N}$$

$$M_{x_max} = 44.09 \text{ Nm}$$

$$M_{y_max} = 28.83 \text{ Nm}$$

$$M_{z_max} = 28.83 \text{ Nm}$$

$$f_v = \frac{|F_{y1}|}{F_{y2}} + \frac{|F_{z1}|}{F_{z2}} + \frac{|M_{x1}|}{M_{x2}} + \frac{|M_{y1}|}{M_{y2}} + \frac{|M_{z1}|}{M_{z2}} \leq 1$$

$$f_v = \frac{0 \text{ N}}{1130 \text{ N}} + \frac{110 \text{ N}}{1130 \text{ N}} + \frac{0 \text{ Nm}}{44,09 \text{ Nm}} + \frac{17,8 \text{ Nm}}{28,83 \text{ Nm}} + \frac{0 \text{ Nm}}{28,83 \text{ Nm}} = 0,72 \leq 1$$

Expected service life

$$L = \frac{L_1}{f_v^3} = \frac{10000 \text{ km}}{0,72^3} = 27000 \text{ km}$$

L_1 = reference service life

Datasheet

Dimensions

∅ 6, 10 mm

Download CAD data → www.festo.com

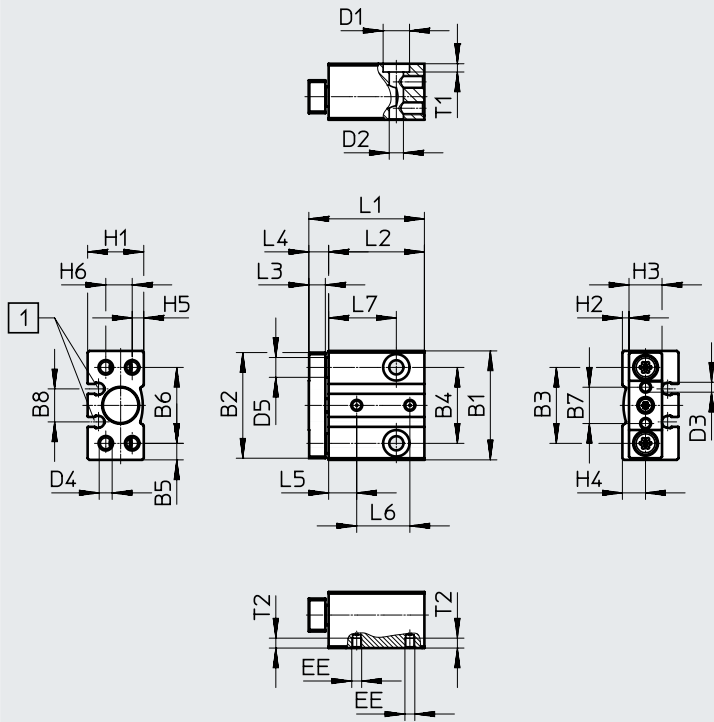

[1] Mounting slot for proximity switch SMT-10G

Datasheet

∅ [mm]	B1	B2	B3	B4	B5	B6	B7	B8	D1 ∅	D2 ∅
6	29	28	20.5	20.5	4.3	20.5	9	9.7	6.2	3.3
10	33	32	23	23	5	23	11	10	8	4.3

∅ [mm]	D3	D4	D5 ∅ h8	EE	H1	H2	H3	H4	H5	H6
6	M2.5	M3	5	M3	14.5	1.8	9	6.3	3	6
10	M3	M4	6	M3	17	2	10	7	3.5	8

∅ [mm]	Stroke [mm]	L1	L2	L3	L4	L5	L6	L7	T1	T2
6	5	28	23.5	3.5	4.5	7	12	14	3	3
	10	33	28.5				17	19		
	15	38	33.5				22	24		
	20	43	38.5				27	29		
10	5	30	24	5	6	8.5	11.1	15.5	2.5	3
	10	35	29				16.1	20.5		
	15	40	34				21.1	25.5		
	20	45	39				26.1	30.5		

Datasheet

Dimensions

∅ 12 ... 16 mm

Download CAD data → www.festo.com

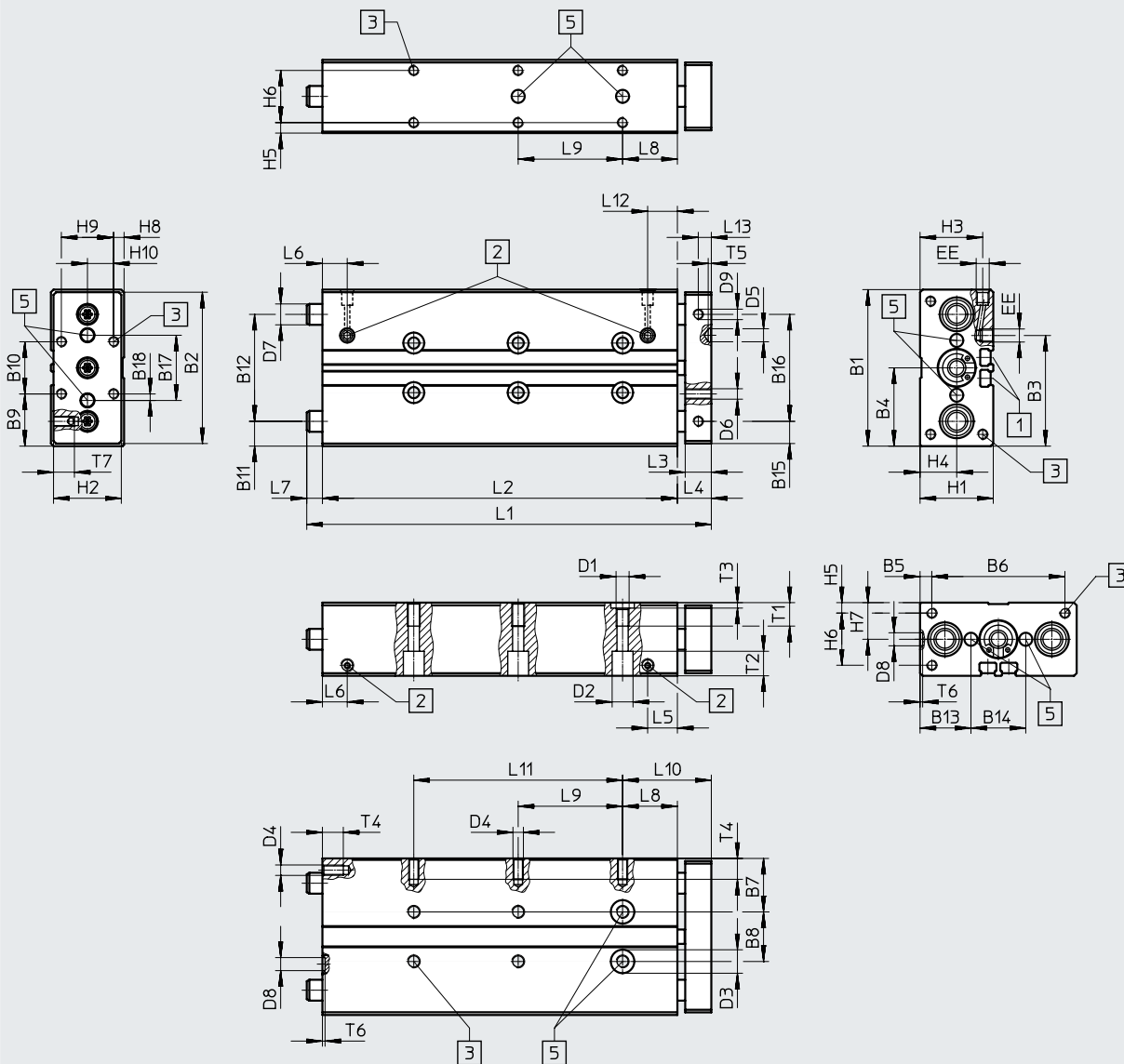

[1] Mounting slot for proximity switch SME/SMT-8

[2] Compressed air connection can be on the side or on top

[5] Tolerance between the centring holes ± 0.02 mm

[3] Mounting thread

Note

If the guide rods project beyond the housing when the unit is in its retracted end position (→ dimension L7), a recess must be provided in the mounting surface if the unit is to be mounted on the end face so that the guide rods can move freely.

Datasheet

∅ [mm]	B1	B2	B3	B4	B5	B6	B7	B8	B9	B10	B11	B12	B13	B14	B15	B16	B17	B18	D1	D2 ∅
12	60	58	42.4	30	4.5	51	20.5	19	20	20	9.5	41	19.5	21	8.5	41	25	2.5	M5	8
16	67	65	45.9	33.5	4.5	58	22	23	23.5	20	10.5	46	21.3	24.4	–	–	28	4	M5	7.5

∅ [mm]	D3 ∅ H8	D4	D5 ∅ H8	D6	D7 ∅		D8 ∅ H8	D9	EE	H1	H2	H3	H4	H5	H6	H7	H8	H9	H10
					GF	KF													
12	9	M4	5	M4	10 _{h8}	8 _{h7}	5	M4	M5	28	26	24	14	4	20	14	4	20	10
16	9	M5	5	M5	12 _{h8}	10 _{h7}	5	–	M5	32	30	26.5	16	4	24	16	7.4	20	10

∅ [mm]	Stroke [mm]	L1	L2	L3	L4	L5	L6	L7	L8	L9	L10
12	10	59	46	10	13	11.4	9.5	–	21	–	34
	20	69	56					–		–	
	25	74	61					–		20	
	30	79	66					–		20	
	40	95	76					6		20	
	50	105	86					6		40	
	80	135	116					6		40	
	100	155	136					6		40	
16	10	60	48	10	12	11.9	10.6	–	22	–	34
	20	70	58					–		–	
	25	75	63					–		20	
	30	80	68					–		20	
	40	107	78					17		20	
	50	117	88					17		40	
	80	147	118					17		40	
	100	167	138					17		40	

∅ [mm]	Stroke [mm]	L11	L12	L13	T1	T2	T3	T4	T5	T6	T7
12	10	–	11.4	5	9	9.4	2.1	8	1.2	1	8
	20	–									
	25	–									
	30	–									
	40	–									
	50	–									
	80	–									
100	80										
16	10	–	11.9	–	9	4.6	2.1	10	1.2	1	–
	20	–									
	25	–									
	30	–									
	40	–									
	50	–									
	80	–									
100	80										

Datasheet

Dimensions

∅ 20 ... 25 mm

Download CAD data → www.festo.com

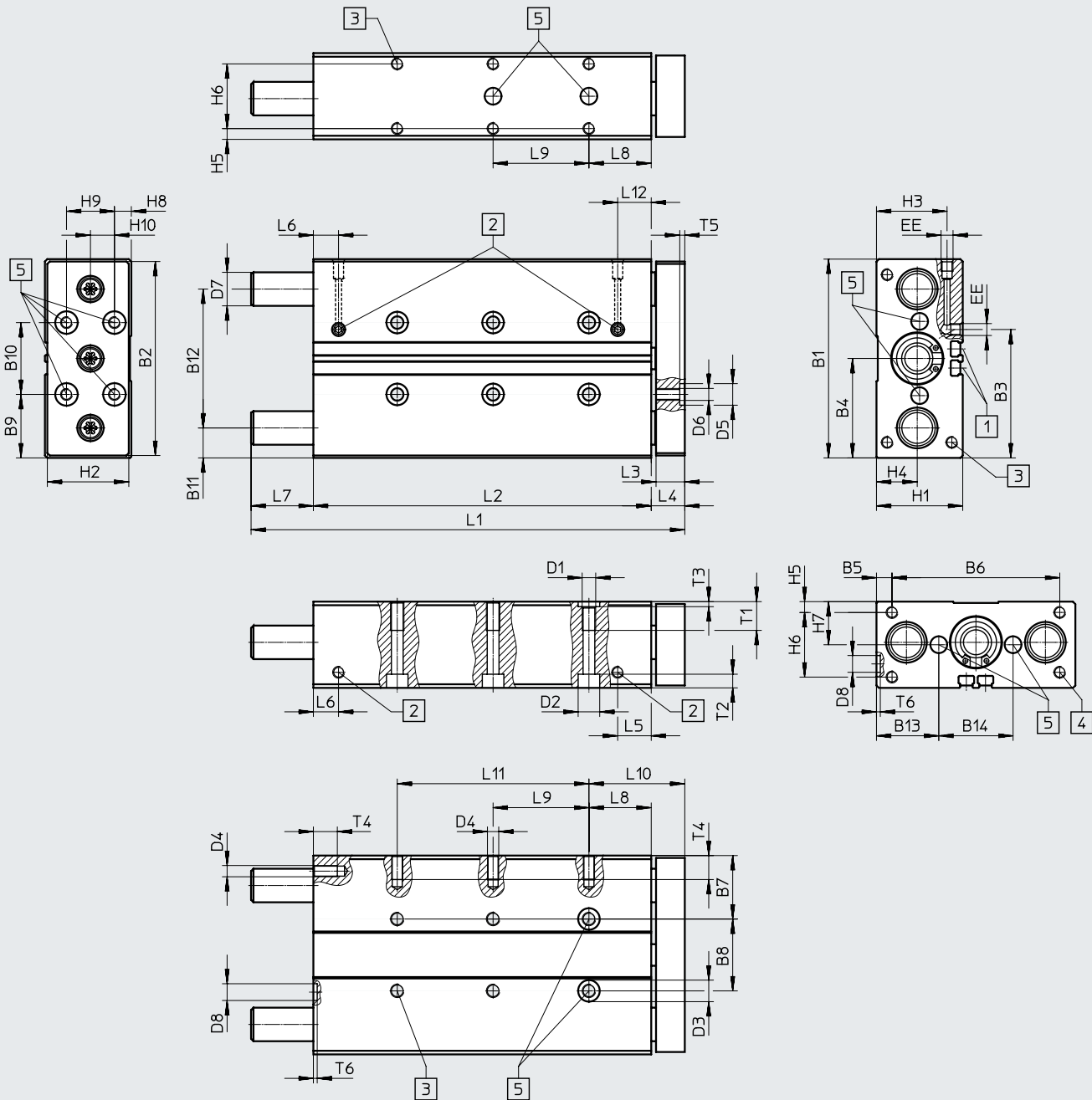

[1] Mounting slot for proximity switch SME-/SMT-8

[2] Compressed air connection can be on the side or on top

[3] Mounting thread
[4] Mounting thread (not with ∅ 20)

[5] Tolerance between the centring holes ± 0.02 mm

Note

If the guide rods project beyond the housing when the unit is in its retracted end position (→ dimension L7), a recess must be provided in the mounting surface if the unit is to be mounted on the end face so that the guide rods can move freely.

Datasheet

∅ [mm]	B1	B2	B3	B4	B5	B6	B7	B8	B9	B10	B11	B12	B13	B14	D1	D2 ∅	D3 ∅ H8	D4
20	83	81	53.6	41.5	6.5	70	26.5	30	26.5	30	12.5	58	26	31	M6	9	9	M5
25	95	93	70	47.5	15.5	64	30	35	27.5	40	13.5	68	29	37	M6	9	9	M6

∅ [mm]	D5 ∅ H8	D6	D7 ∅		D8 ∅ H8	EE	H1	H2	H3	H4	H5	H6	H7	H8	H9	H10
			GF	KF												
20	9	M5	14 _{h8}	12 _{h7}	7	M5	36	34	29.5	17	4.5	27	18	7	20	10
25	9	M6	16 _{h8}	14 _{h7}	7	G1/8	44	42	34.8	19	4.5	35	22	12	20	10

∅ [mm]	Stroke [mm]	L1	L2	L3	L4	L5	L6	L7	L8	L9
20	20	75	61	12	14	14	10.5	-	26	-
	25							-		20
	30							-		20
	40							26		20
	50							26		40
	80							26		40
	100							26		40
25	20	93	65.6	12	14	17.5	9.5	13.4	26	-
	25							13.4		20
	30							13.4		20
	40							23.4		20
	50							23.4		40
	80							23.4		40
	100							23.4		40

∅ [mm]	Stroke [mm]	L10	L11	L12	T1	T2	T3	T4	T5	T6
20	20	40	-	14	12	5.7	2.1	10	2.1	1.6
	25		-							
	30		-							
	40		-							
	50		-							
	80		-							
	100		80							
25	20	40	-	15	14	5.7	2.1	12	2.1	1.6
	25		-							
	30		-							
	40		-							
	50		-							
	80		-							
	100		80							

† Note: This product conforms to ISO 1179-1 and ISO 228-1.

Datasheet

Dimensions

∅ 32 ... 63 mm

Download CAD data → www.festo.com

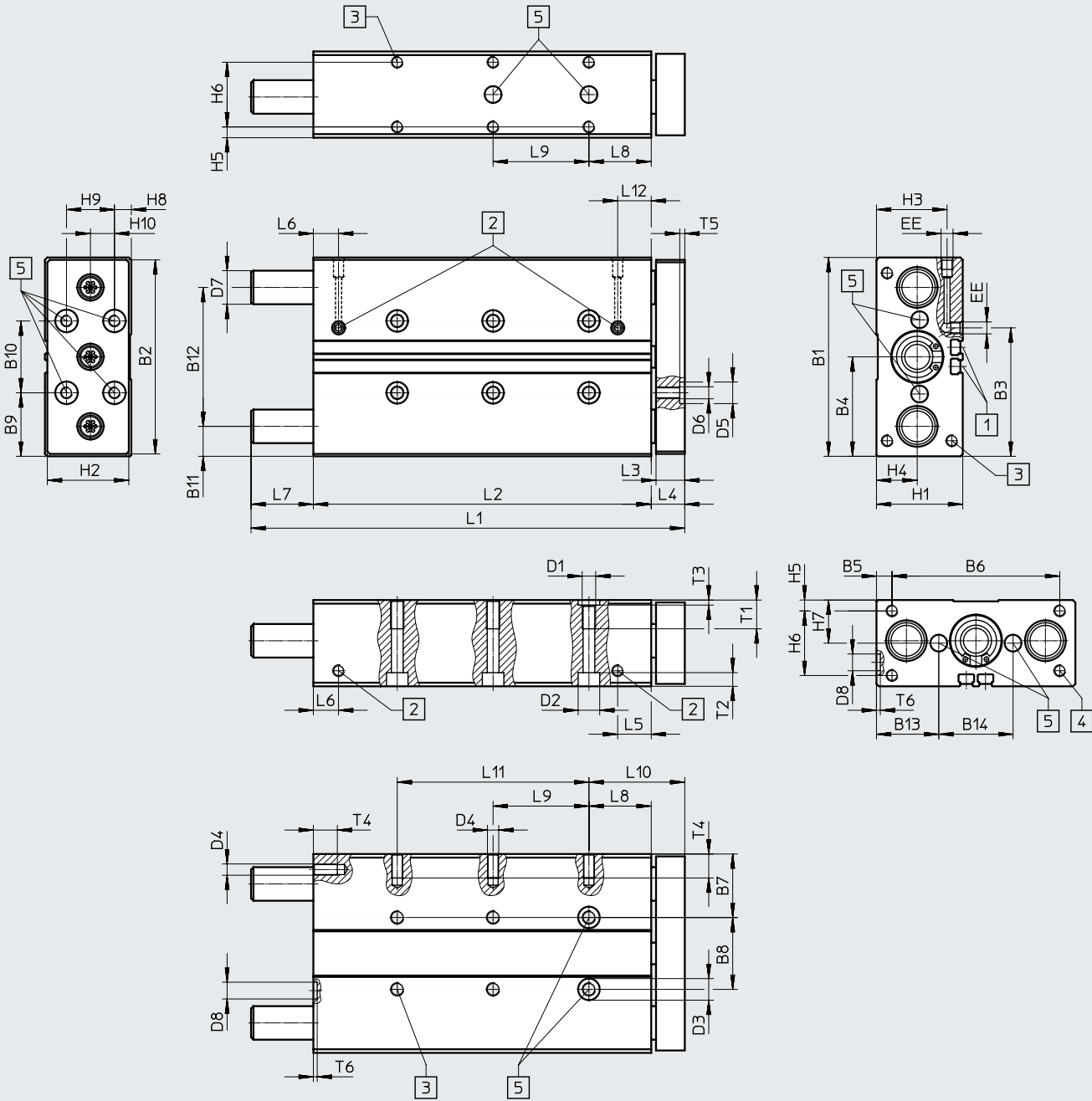

- [1] Mounting slot for proximity switch SME-/SMT-8
- [2] Compressed air connection can be on the side or on top
- [3] Mounting thread
- [4] Mounting thread
- [5] Tolerance between the centring holes ± 0.02 mm

Note

As the guide rods project beyond the housing when the unit is in its retracted end position (→ dimension L7), a recess must be provided in the mounting surface if the unit is to be mounted on the end face so that the guide rods can move freely.

Datasheet

∅ [mm]	B1	B2	B3	B4	B5	B6	B7	B8	B9	B10	B11	B12	B13	B14	D1	D2 ∅	D3 ∅ H8
32	110	108	81	55	20	70	33.5	43	35	40	16	78	32.5	45	M8	11	12
40	120	118	94	60	15	90	34.5	51	35	50	16	88	32.5	55	M8	11	12
50	148	146	116.5	74	19	110	42	64	44	60	19	110	40	68	M8	11	12
63	162	160	139	81	9	144	41	80	41	80	18.5	125	39.5	83	M10	15	12

∅ [mm]	D4	D5 ∅ H8	D6	D7 ∅		D8 ∅ H8	EE	H1	H2	H3	H4	H5	H6	H7	H8	H9	H10
				GF	KF												
32	M6	9	M6	20 _{h8}	16 _{h7}	9	G1/8	49	47	38.5	22	6	37	24.5	8.5	30	15
40	M8	9	M6	20 _{h8}	16 _{h7}	9	G1/8	54	52	40.5	24	6	42	27	10	30	15
50	M8	12	M8	25 _{h8}	20 _{h7}	12	G1/4	64	62	50.5	29.5	7	50	32	12	40	20
63	M10	12	M8	25 _{h8}	20 _{h7}	12	G1/4	78	76	55	32	9	60	39	19	40	20

∅ [mm]	Stroke [mm]	L1	L2	L3	L4	L5	L6	L7	L8	L9	L10	L11	L12	T1	T2	T3	T4	T5	T6
32	20	101	68	14	16	17	12	17	29	-	45	-	17	15	6.8	2.6	12	2.1	2.1
	25	106	73					17		20		-							
	30	111	78					17		20		-							
	40	121	88					17		20		-							
	50	131	98					17		40		-							
	80	179	128					35		40		-							
	100	199	148					35		40		80							
	125	244	173					55		40		80							
	160	279	208					55		40		120							
	200	319	248					55		40		160							
40	25	106	76	14	16	17.8	13.1	14	29	20	45	-	17.8	15	6.8	2.6	16	2.1	2.1
	50	131	101					14		40		-							
	80	179	131					32		40		-							
	100	199	151					32		40		80							
	125	244	176					52		40		80							
	160	279	211					52		40		120							
200	319	251	52	40	160														
50	25	118	77	16	18	17.8	14.2	23	32	20	50	-	17.8	15	6.8	2.6	16	2.6	2.6
	50	143	102					23		40		-							
	80	194	132					44		40		-							
	100	214	152					44		40		80							
	125	259	177					64		40		80							
	160	294	212					64		40		120							
200	334	252	64	40	160														
63	25	118	83	16	18	18.5	14.8	17	32	20	50	-	18.5	20	9	2.6	20	2.6	2.6
	50	143	108					17		40		-							
	80	194	138					38		40		80							
	100	214	158					38		40		80							
	125	259	183					58		40		120							
	160	294	218					58		40		160							
200	334	258	58	40	200														

† Note: This product conforms to ISO 1179-1 and ISO 228-1.

Datasheet

Dimensions

Download CAD data → www.festo.com

∅ 80 ... 100 mm

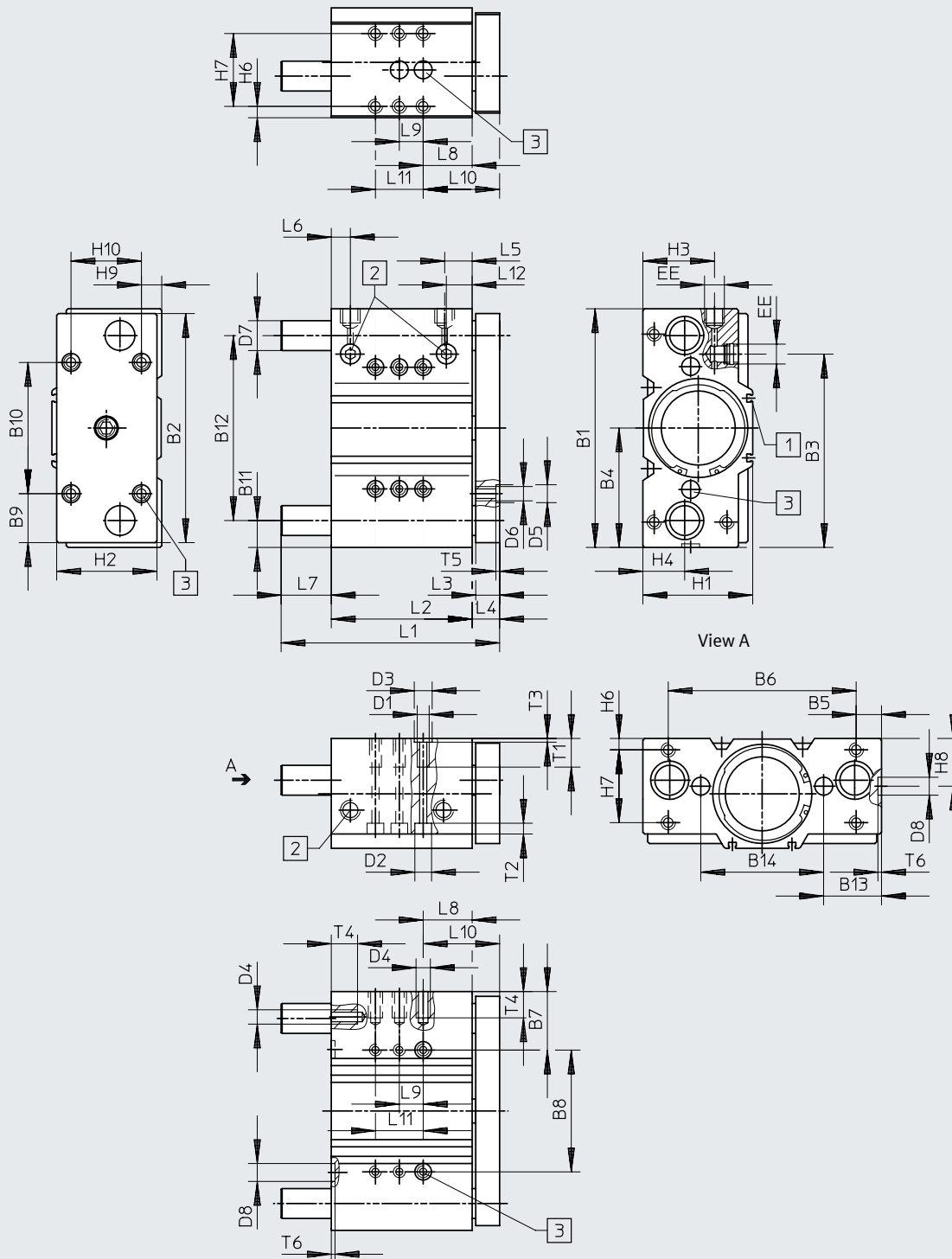

[1] Mounting slot for proximity switch SME-/SMT-8

[2] Compressed air connection can be on the side or on top

[3] Tolerance between the centring holes ± 0.02 mm

 Note

As the guide rods project beyond the housing when the unit is in its retracted end position (→ dimension L7), a recess must be provided in the mounting surface if the unit is to be mounted on the end face so that the guide rods can move freely.

Datasheet

∅ [mm]	B1	B2	B3	B4	B5	B6	B7	B8	B9	B10	B11	B12	B13	B14	D1	D2 ∅	D3 ∅ H8
80	200	192	162.5	100	21.5	157	48.5	103	41	110	22.5	155	48.5	103	M10	15	12
100	240	232	201	120	21	198	54	132	56	120	26	188	57	126	M12	18	15

∅ [mm]	D4	D5 ∅ H8	D6	D7 ∅		D8 ∅ H8	EE	H1	H2	H3	H4	H6	H7	H8	H9	H10
				GF	KF											
80	M10	12	M10	30h8	25h6	12	G3/8	92	84	61	35	9	62	40	16	60
100	M12	15	M12	35h8	30h6	15	G3/8	112	104	66	39.5	10	68	44	16	80

∅ [mm]	Stroke [mm]	L1	L2	L3	L4	L5	L6	L7	L8	L9	L10 ±0.1	L11	L12	T1	T2	T3	T4	T5	T6
	50	183	118	42	40	-													
	80	243	148	72	40	-													
	100	263	168	72	40	80													
	125	288	193	72	40	80													
	160	323	228	72	40	120													
	200	363	268	72	40	160													
100	25	150	109	20	23	29	20	18	13	40	36	-	29	25	11	3.1	24	3.1	3.1
	50	197	134					40		40		80							
	80	257	164					70		40		80							
	100	277	184					70		40		120							
	125	302	209					70		40		160							
	160	337	244					70		40		160							
	200	377	284					70		40		200							

Note: This product conforms to ISO 1179-1 and ISO 228-1.

Datasheet

Ordering data – Plain-bearing guide GF						
Part no.		Type	Part no.		Type	
Stroke [mm]	∅ 6 mm		∅ 10 mm			
5	★ 4149944	DFM-6-5-P-A-GF	★ 4154768	DFM-10-5-P-A-GF	-	
10	★ 4149945	DFM-6-10-P-A-GF	★ 4154769	DFM-10-10-P-A-GF		
15	★ 4149946	DFM-6-15-P-A-GF	★ 4154770	DFM-10-15-P-A-GF		
20	★ 4149947	DFM-6-20-P-A-GF	★ 4154799	DFM-10-20-P-A-GF		
Stroke [mm]	∅ 12 mm		∅ 16 mm		∅ 20 mm	
10	★ 170824	DFM-12-10-P-A-GF	★ 170832	DFM-16-10-P-A-GF	-	
20	★ 170825	DFM-12-20-P-A-GF	★ 170833	DFM-16-20-P-A-GF	★ 170840	DFM-20-20-P-A-GF
25	★ 170826	DFM-12-25-P-A-GF	★ 170834	DFM-16-25-P-A-GF	★ 170841	DFM-20-25-P-A-GF
30	★ 170827	DFM-12-30-P-A-GF	★ 170835	DFM-16-30-P-A-GF	★ 170842	DFM-20-30-P-A-GF
40	★ 170828	DFM-12-40-P-A-GF	★ 170836	DFM-16-40-P-A-GF	★ 170843	DFM-20-40-P-A-GF
50	★ 170829	DFM-12-50-P-A-GF	★ 170837	DFM-16-50-P-A-GF	★ 170844	DFM-20-50-P-A-GF
80	★ 170830	DFM-12-80-P-A-GF	★ 170838	DFM-16-80-P-A-GF	★ 170845	DFM-20-80-P-A-GF
100	★ 170831	DFM-12-100-P-A-GF	★ 170839	DFM-16-100-P-A-GF	★ 170846	DFM-20-100-P-A-GF
Stroke [mm]	∅ 25 mm		∅ 32 mm		∅ 40 mm	
20	★ 170847	DFM-25-20-P-A-GF	★ 170854	DFM-32-20-P-A-GF	-	
25	★ 170848	DFM-25-25-P-A-GF	★ 170855	DFM-32-25-P-A-GF	★ 170864	DFM-40-25-P-A-GF
30	★ 170849	DFM-25-30-P-A-GF	★ 170856	DFM-32-30-P-A-GF	-	
40	★ 170850	DFM-25-40-P-A-GF	★ 170857	DFM-32-40-P-A-GF	★ 170865	DFM-40-50-P-A-GF
50	★ 170851	DFM-25-50-P-A-GF	★ 170858	DFM-32-50-P-A-GF	★ 170866	DFM-40-80-P-A-GF
80	★ 170852	DFM-25-80-P-A-GF	★ 170859	DFM-32-80-P-A-GF	★ 170867	DFM-40-100-P-A-GF
100	★ 170853	DFM-25-100-P-A-GF	★ 170860	DFM-32-100-P-A-GF	★ 170868	DFM-40-125-P-A-GF
125	-		★ 170861	DFM-32-125-P-A-GF	★ 170869	DFM-40-160-P-A-GF
160			★ 170862	DFM-32-160-P-A-GF	★ 170870	DFM-40-200-P-A-GF
200			★ 170863	DFM-32-200-P-A-GF		
Stroke [mm]	∅ 50 mm		∅ 63 mm		-	
25	★ 170871	DFM-50-25-P-A-GF	★ 170878	DFM-63-25-P-A-GF		
50	★ 170872	DFM-50-50-P-A-GF	★ 170879	DFM-63-50-P-A-GF		
80	★ 170873	DFM-50-80-P-A-GF	★ 170880	DFM-63-80-P-A-GF		
100	★ 170874	DFM-50-100-P-A-GF	★ 170881	DFM-63-100-P-A-GF		
125	★ 170875	DFM-50-125-P-A-GF	★ 170882	DFM-63-125-P-A-GF		
160	★ 170876	DFM-50-160-P-A-GF	★ 170883	DFM-63-160-P-A-GF		
200	★ 170877	DFM-50-200-P-A-GF	★ 170884	DFM-63-200-P-A-GF		

Ordering data – Plain-bearing guide GF					
Part no.		Type	Part no.		Type
Stroke [mm]	∅ 80 mm		∅ 100 mm		
25	170885	DFM-80-25-P-A-GF	170892	DFM-100-25-P-A-GF	
50	170886	DFM-80-50-P-A-GF	170893	DFM-100-50-P-A-GF	
80	170887	DFM-80-80-P-A-GF	170894	DFM-100-80-P-A-GF	
100	170888	DFM-80-100-P-A-GF	170895	DFM-100-100-P-A-GF	
125	170889	DFM-80-125-P-A-GF	170896	DFM-100-125-P-A-GF	
160	170890	DFM-80-160-P-A-GF	170897	DFM-100-160-P-A-GF	
200	170891	DFM-80-200-P-A-GF	170898	DFM-100-200-P-A-GF	

Datasheet

Ordering data – Plain-bearing guide GF and variant F1A (recommended for production facilities for manufacturing lithium-ion batteries)										
		Part no.		Type		Part no.		Type		
Stroke [mm]	∅ 12 mm					∅ 16 mm				
10	8118623	DFM-12-10-P-A-GF-F1A			8118822	DFM-16-10-P-A-GF-F1A				
20	8118624	DFM-12-20-P-A-GF-F1A			8118823	DFM-16-20-P-A-GF-F1A				
25	8118625	DFM-12-25-P-A-GF-F1A			8118824	DFM-16-25-P-A-GF-F1A				
30	8118626	DFM-12-30-P-A-GF-F1A			8118825	DFM-16-30-P-A-GF-F1A				
40	8118627	DFM-12-40-P-A-GF-F1A			8118826	DFM-16-40-P-A-GF-F1A				
50	8118628	DFM-12-50-P-A-GF-F1A			8118827	DFM-16-50-P-A-GF-F1A				
80	8118629	DFM-12-80-P-A-GF-F1A			8118828	DFM-16-80-P-A-GF-F1A				
100	8118630	DFM-12-100-P-A-GF-F1A			8118829	DFM-16-100-P-A-GF-F1A				
Stroke [mm]	∅ 20 mm					∅ 25 mm				
20	8118843	DFM-20-20-P-A-GF-F1A			8118862	DFM-25-20-P-A-GF-F1A				
25	8118844	DFM-20-25-P-A-GF-F1A			8118863	DFM-25-25-P-A-GF-F1A				
30	8118845	DFM-20-30-P-A-GF-F1A			8118864	DFM-25-30-P-A-GF-F1A				
40	8118846	DFM-20-40-P-A-GF-F1A			8118865	DFM-25-40-P-A-GF-F1A				
50	8118847	DFM-20-50-P-A-GF-F1A			8118866	DFM-25-50-P-A-GF-F1A				
80	8118848	DFM-20-80-P-A-GF-F1A			8118867	DFM-25-80-P-A-GF-F1A				
100	8118849	DFM-20-100-P-A-GF-F1A			8118868	DFM-25-100-P-A-GF-F1A				
Stroke [mm]	∅ 32 mm					∅ 40 mm				
20	8118881	DFM-32-20-P-A-GF-F1A			8118907	DFM-40-20-P-A-GF-F1A				
25	8118882	DFM-32-25-P-A-GF-F1A			8118908	DFM-40-25-P-A-GF-F1A				
30	8118883	DFM-32-30-P-A-GF-F1A			8118909	DFM-40-30-P-A-GF-F1A				
40	8118884	DFM-32-40-P-A-GF-F1A			8118910	DFM-40-40-P-A-GF-F1A				
50	8118885	DFM-32-50-P-A-GF-F1A			8118911	DFM-40-50-P-A-GF-F1A				
80	8118886	DFM-32-80-P-A-GF-F1A			8118912	DFM-40-80-P-A-GF-F1A				
100	8118887	DFM-32-100-P-A-GF-F1A			8118913	DFM-40-100-P-A-GF-F1A				
125	8118888	DFM-32-125-P-A-GF-F1A			-					
160	8118889	DFM-32-160-P-A-GF-F1A								
200	8118890	DFM-32-200-P-A-GF-F1A								
Stroke [mm]	∅ 50 mm					∅ 63 mm				
25	8118927	DFM-50-25-P-A-GF-F1A			8118947	DFM-63-25-P-A-GF-F1A				
50	8118928	DFM-50-50-P-A-GF-F1A			8118948	DFM-63-50-P-A-GF-F1A				
80	8118929	DFM-50-80-P-A-GF-F1A			8118949	DFM-63-80-P-A-GF-F1A				
100	8118930	DFM-50-100-P-A-GF-F1A			8118950	DFM-63-100-P-A-GF-F1A				
125	8118931	DFM-50-125-P-A-GF-F1A			8118951	DFM-63-125-P-A-GF-F1A				
160	8118932	DFM-50-160-P-A-GF-F1A			8118952	DFM-63-160-P-A-GF-F1A				
200	8118933	DFM-50-200-P-A-GF-F1A			8118953	DFM-63-200-P-A-GF-F1A				

Datasheet

Ordering data – Recirculating ball bearing guide KF						
	Part no.	Type	Part no.	Type	Part no.	Type
Stroke [mm]	∅ 12 mm		∅ 16 mm		∅ 20 mm	
10	★ 170899	DFM-12-10-P-A-KF	★ 170907	DFM-16-10-P-A-KF	-	
20	★ 170900	DFM-12-20-P-A-KF	★ 170908	DFM-16-20-P-A-KF	★ 170915	DFM-20-20-P-A-KF
25	★ 170901	DFM-12-25-P-A-KF	★ 170909	DFM-16-25-P-A-KF	★ 170916	DFM-20-25-P-A-KF
30	★ 170902	DFM-12-30-P-A-KF	★ 170910	DFM-16-30-P-A-KF	★ 170917	DFM-20-30-P-A-KF
40	★ 170903	DFM-12-40-P-A-KF	★ 170911	DFM-16-40-P-A-KF	★ 170918	DFM-20-40-P-A-KF
50	★ 170904	DFM-12-50-P-A-KF	★ 170912	DFM-16-50-P-A-KF	★ 170919	DFM-20-50-P-A-KF
80	★ 170905	DFM-12-80-P-A-KF	★ 170913	DFM-16-80-P-A-KF	★ 170920	DFM-20-80-P-A-KF
100	★ 170906	DFM-12-100-P-A-KF	★ 170914	DFM-16-100-P-A-KF	★ 170921	DFM-20-100-P-A-KF
Stroke [mm]	∅ 25 mm		∅ 32 mm		∅ 40 mm	
20	★ 170922	DFM-25-20-P-A-KF	★ 170929	DFM-32-20-P-A-KF	-	
25	★ 170923	DFM-25-25-P-A-KF	★ 170930	DFM-32-25-P-A-KF	★ 170939	DFM-40-25-P-A-KF
30	★ 170924	DFM-25-30-P-A-KF	★ 170931	DFM-32-30-P-A-KF	-	
40	★ 170925	DFM-25-40-P-A-KF	★ 170932	DFM-32-40-P-A-KF	★ 170940	DFM-40-50-P-A-KF
50	★ 170926	DFM-25-50-P-A-KF	★ 170933	DFM-32-50-P-A-KF	★ 170941	DFM-40-80-P-A-KF
80	★ 170927	DFM-25-80-P-A-KF	★ 170934	DFM-32-80-P-A-KF	★ 170942	DFM-40-100-P-A-KF
100	★ 170928	DFM-25-100-P-A-KF	★ 170935	DFM-32-100-P-A-KF	★ 170943	DFM-40-125-P-A-KF
125	-		★ 170936	DFM-32-125-P-A-KF	★ 170944	DFM-40-160-P-A-KF
160			★ 170937	DFM-32-160-P-A-KF	★ 170945	DFM-40-200-P-A-KF
200			★ 170938	DFM-32-200-P-A-KF		
Stroke [mm]	∅ 50 mm		∅ 63 mm		-	
25	★ 170946	DFM-50-25-P-A-KF	★ 170953	DFM-63-25-P-A-KF		
50	★ 170947	DFM-50-50-P-A-KF	★ 170954	DFM-63-50-P-A-KF		
80	★ 170948	DFM-50-80-P-A-KF	★ 170955	DFM-63-80-P-A-KF		
100	★ 170949	DFM-50-100-P-A-KF	★ 170956	DFM-63-100-P-A-KF		
125	★ 170950	DFM-50-125-P-A-KF	★ 170957	DFM-63-125-P-A-KF		
160	★ 170951	DFM-50-160-P-A-KF	★ 170958	DFM-63-160-P-A-KF		
200	★ 170952	DFM-50-200-P-A-KF	★ 170959	DFM-63-200-P-A-KF		

Ordering data – Recirculating ball bearing guide KF					
	Part no.	Type	Part no.	Type	
Stroke [mm]	∅ 80 mm		∅ 100 mm		
25	170960	DFM-80-25-P-A-KF	170967	DFM-100-25-P-A-KF	
50	170961	DFM-80-50-P-A-KF	170968	DFM-100-50-P-A-KF	
80	170962	DFM-80-80-P-A-KF	170969	DFM-100-80-P-A-KF	
100	170963	DFM-80-100-P-A-KF	170970	DFM-100-100-P-A-KF	
125	170964	DFM-80-125-P-A-KF	170971	DFM-100-125-P-A-KF	
160	170965	DFM-80-160-P-A-KF	170972	DFM-100-160-P-A-KF	
200	170966	DFM-80-200-P-A-KF	170973	DFM-100-200-P-A-KF	

Datasheet

Ordering data – Recirculating ball bearing guide KF and variant F1A (recommended for production facilities for manufacturing lithium-ion batteries)						
	Part no.	Type	Part no.	Type	Part no.	Type
Stroke [mm]	∅ 12 mm		∅ 16 mm		∅ 20 mm	
10	8118631	DFM-12-10-P-A-KF-F1A	8118830	DFM-16-10-P-A-KF-F1A	–	
20	8118632	DFM-12-20-P-A-KF-F1A	8118831	DFM-16-20-P-A-KF-F1A	8118850	DFM-20-20-P-A-KF-F1A
25	8118633	DFM-12-25-P-A-KF-F1A	8118832	DFM-16-25-P-A-KF-F1A	8118851	DFM-20-25-P-A-KF-F1A
30	8118634	DFM-12-30-P-A-KF-F1A	8118833	DFM-16-30-P-A-KF-F1A	8118852	DFM-20-30-P-A-KF-F1A
40	8118635	DFM-12-40-P-A-KF-F1A	8118834	DFM-16-40-P-A-KF-F1A	8118853	DFM-20-40-P-A-KF-F1A
50	8118636	DFM-12-50-P-A-KF-F1A	8118835	DFM-16-50-P-A-KF-F1A	8118854	DFM-20-50-P-A-KF-F1A
80	8118637	DFM-12-80-P-A-KF-F1A	8118836	DFM-16-80-P-A-KF-F1A	8118855	DFM-20-80-P-A-KF-F1A
100	8118638	DFM-12-100-P-A-KF-F1A	8118837	DFM-16-100-P-A-KF-F1A	8118856	DFM-20-100-P-A-KF-F1A
Stroke [mm]	∅ 25 mm		∅ 32 mm		∅ 40 mm	
20	8118869	DFM-25-20-P-A-KF-F1A	8118891	DFM-32-20-P-A-KF-F1A	–	
25	8118870	DFM-25-25-P-A-KF-F1A	8118892	DFM-32-25-P-A-KF-F1A	8118914	DFM-40-25-P-A-KF-F1A
30	8118871	DFM-25-30-P-A-KF-F1A	8118893	DFM-32-30-P-A-KF-F1A	–	
40	8118872	DFM-25-40-P-A-KF-F1A	8118894	DFM-32-40-P-A-KF-F1A	–	
50	8118873	DFM-25-50-P-A-KF-F1A	8118895	DFM-32-50-P-A-KF-F1A	8118915	DFM-40-50-P-A-KF-F1A
80	8118874	DFM-25-80-P-A-KF-F1A	8118896	DFM-32-80-P-A-KF-F1A	8118916	DFM-40-80-P-A-KF-F1A
100	8118875	DFM-25-100-P-A-KF-F1A	8118897	DFM-32-100-P-A-KF-F1A	8118917	DFM-40-100-P-A-KF-F1A
125	–		8118898	DFM-32-125-P-A-KF-F1A	8118918	DFM-40-125-P-A-KF-F1A
160	–		8118899	DFM-32-160-P-A-KF-F1A	8118919	DFM-40-160-P-A-KF-F1A
200	–		8118900	DFM-32-200-P-A-KF-F1A	8118920	DFM-40-200-P-A-KF-F1A
Stroke [mm]	∅ 50 mm		∅ 63 mm		–	
25	8118934	DFM-50-25-P-A-KF-F1A	8118954	DFM-63-25-P-A-KF-F1A	–	
50	8118935	DFM-50-50-P-A-KF-F1A	8118955	DFM-63-50-P-A-KF-F1A	–	
80	8118936	DFM-50-80-P-A-KF-F1A	8118956	DFM-63-80-P-A-KF-F1A	–	
100	8118937	DFM-50-100-P-A-KF-F1A	8118957	DFM-63-100-P-A-KF-F1A	–	
125	8118938	DFM-50-125-P-A-KF-F1A	8118958	DFM-63-125-P-A-KF-F1A	–	
160	8118939	DFM-50-160-P-A-KF-F1A	8118959	DFM-63-160-P-A-KF-F1A	–	
200	8118940	DFM-50-200-P-A-KF-F1A	8118960	DFM-63-200-P-A-KF-F1A	–	

Peripherals overview

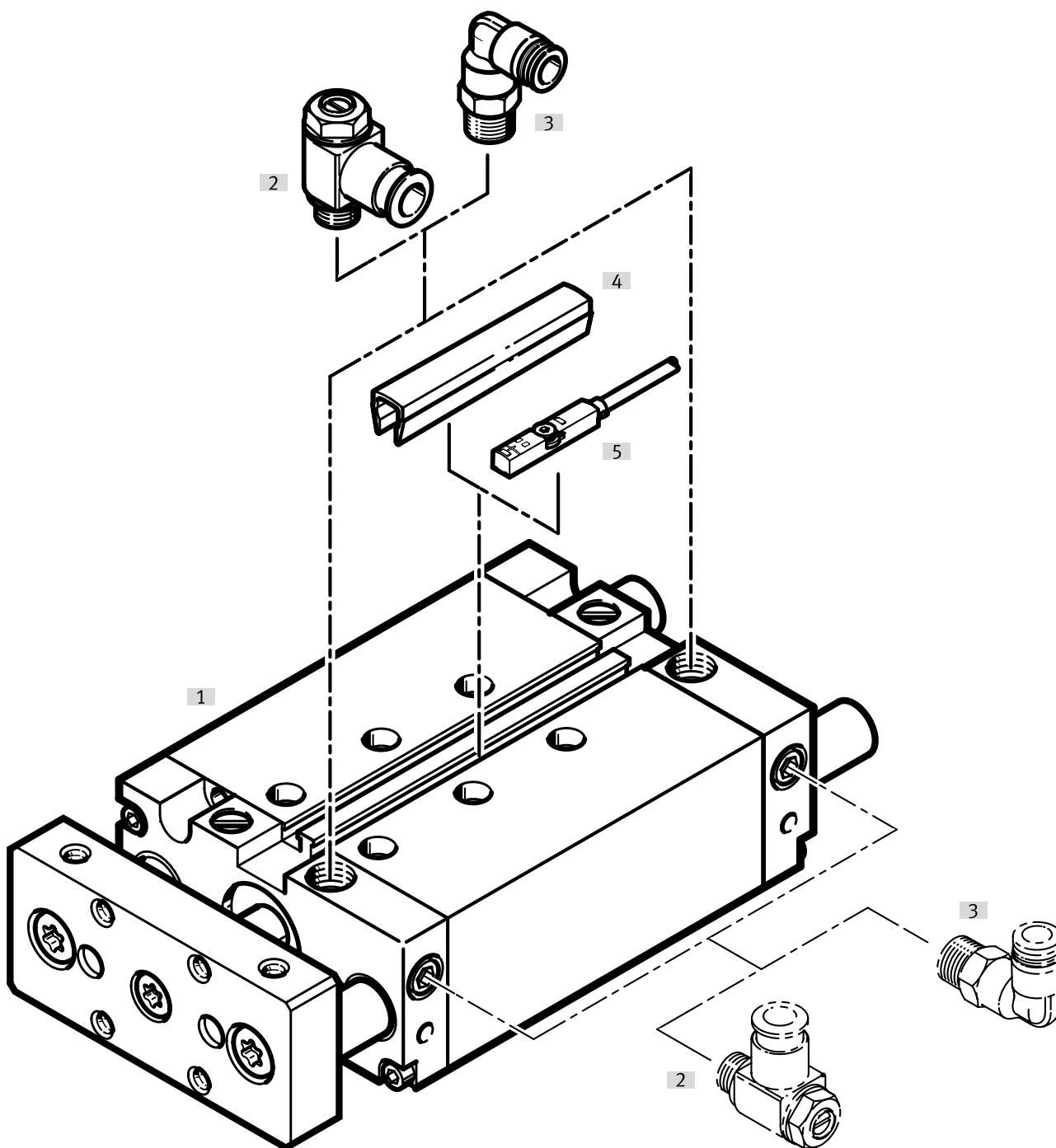

DFM-B-12-P

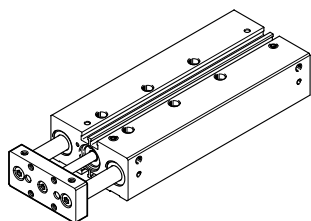

DFM-B-12-P-AJ

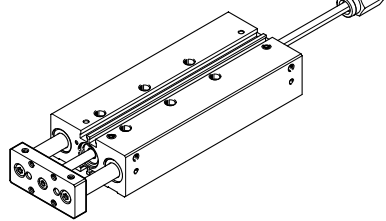

-  - **Note**

Proximity switch SM...O-8E cannot be used with the DFM-B.

Peripherals overview

Accessories		Description	→ Page/Internet
[1]	Guided drive DFM-B	Guided drive, function-optimised	42
[2]	One-way flow control valve GRLA	For regulating speed	77
[3]	Push-in fitting QS	For connecting tubing with standard O.D.	qs
[4]	Slot cover ABP-5-S	For protecting the sensor cables and the sensor slots from contamination	77
[5]	Proximity switch SME-/SMT-8/10	Can be integrated in the profile barrel	76
-	Centring sleeves ZBH	4 or 6 included in the scope of delivery	75

Variants

AJ

EJ

AJ + EJ

YSRW

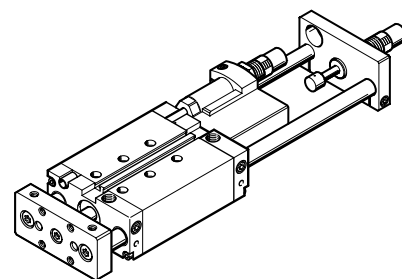
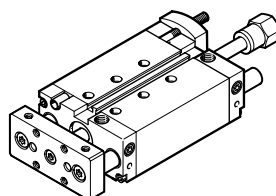
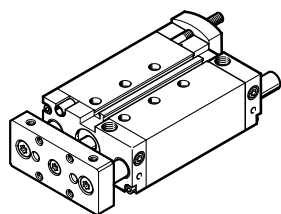
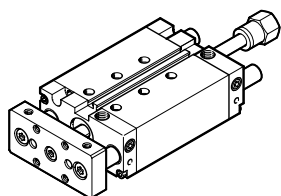

Datasheet

Function

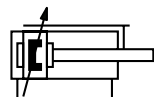
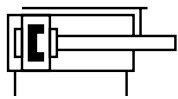

- Diameter
12 ... 63 mm
- Stroke length
10 ... 400 mm

- www.festo.com
- Repair service
Piston \varnothing 12 ... 63 mm

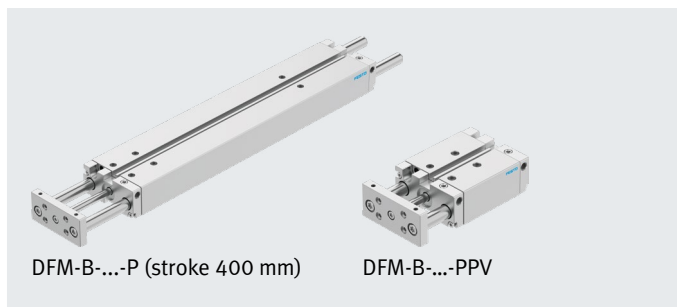

DFM-B-...-P (stroke 400 mm)

DFM-B-...-PPV

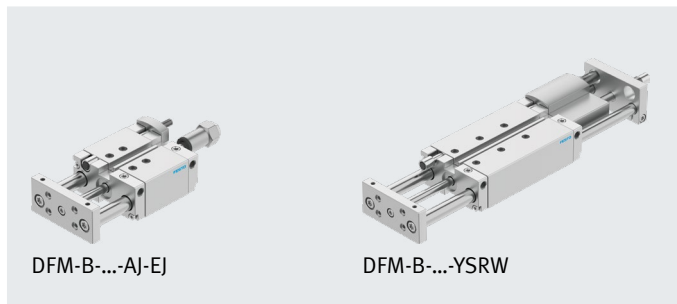

DFM-B-...-AJ-EJ

DFM-B-...-YSRW

$$v = \sqrt{\frac{2 \cdot E}{m_1 + m_2}}$$

$$m_2 = \frac{2 \cdot E}{v^2} - m_1$$

General technical data									
Piston \varnothing	12	16	20	25	32	40	50	63	
Pneumatic connection	M5	M5	M5	G1/8	G1/8	G1/8	G1/4	G1/4	
Design	Piston								
	Piston rod								
	Guide rods with yoke								
Cushioning									
DFM-...-P	Elastic cushioning rings/plates at both ends								
DFM-...-PPV	Pneumatic cushioning adjustable at both ends								
DFM-...-YSRW	Self-adjusting at both ends								
Cushioning length									
DFM-...-PPV	[mm]	-	12	15	15	16	17	19	19
Position sensing	Via proximity switch								
Type of mounting	Via through-hole								
	With female thread								
Mounting position	Any								
Protection against rotation/guide	Guide rod with yoke/plain-bearing or recirculating ball bearing guide								
Variant AJ									
Setting range	[mm]	0 ... 10							
Variant EJ and YSRW									
Setting range	[mm]	-	-	0 ... 10					
Variant YSRW with shock absorber									
Repetition accuracy	[mm]	-	-	Max. 0.05					

Note: This product conforms to ISO 1179-1 and ISO 228-1.

Datasheet

Operating and environmental conditions										
Piston ø		12	16	20	25	32	40	50	63	
Operating pressure										
	[MPa]	0.2 ... 1			0.15 ... 1			0.1 ... 1		
	[bar]	2 ... 10			1.5 ... 10			1 ... 10		
Operating medium		Compressed air to ISO 8573-1:2010 [7:4:4]								
Note on operating/pilot medium		Lubricated operation possible (in which case lubricated operation will always be required)								
Ambient temperature¹⁾										
DFM-...-GF	[°C]	-20 ... +80								
DFM-...-KF	[°C]	-5 ... +60								
DFM-...-YSRW	[°C]	0 ... +60								
DFM-...-S6	[°C]	0 ... +120								
Corrosion resistance class CRC²⁾										
DFM-...-GF		2 - Moderate corrosion stress								
DFM-...-S6		2 - Moderate corrosion stress								
Cleanroom class		-	7 according to ISO 14644-1					-		
ATEX		Selected types → www.festo.com								

1) Note operating range of proximity switches

2) More information: www.festo.com/x/topic/crc

Speeds [m/s]									
Piston ø		12	16	20	25	32	40	50	63
Cushioning P, precision stroke adjustment AJ and EJ									
Maximum speed advancing, retracting		0.8	0.8	0.8	0.8	0.8	0.8	0.6	0.6
Cushioning P, plain-bearing guide GF in conjunction with S6									
Maximum speed advancing, retracting		0.5	0.5	0.5	0.5	0.5	0.5	0.4	0.4
Cushioning PPV, YSRW, PPV S6									
Maximum speed advancing, retracting		-	1.5	1.5	1.5	1.5	1.5	1	1

Forces [N]									
Piston ø		12	16	20	25	32	40	50	63
Cushioning P, PPV, YSRW, precision stroke adjustment EJ									
Theoretical force at 0.6 MPa (6 bar, 87 psi), advancing		68	121	188	295	482	754	1178	1870
Theoretical force at 0.6 MPa (6 bar, 87 psi), retracting		51	90	141	247	415	686	1057	1750
Precision stroke adjustment AJ and AJ+EJ									
Theoretical force at 0.6 MPa (6 bar, 87 psi), advancing		51	90	141	247	415	686	1057	1750
Theoretical force at 0.6 MPa (6 bar, 87 psi), retracting		51	90	141	247	415	686	1057	1750

Datasheet

Impact energy [J]								
Piston \varnothing	12	16	20	25	32	40	50	63
Cushioning P								
Max. impact energy in the end positions	0.09	0.15	0.2	0.35	0.40	0.7	1.0	1.3
Max. impact energy in the end positions S6	0.035	0.075	0.1	0.15	0.2	0.35	0.5	0.65
Cushioning YSRW								
Max. energy absorption per stroke	–	–	4	8	12	35	35	70
Max. energy absorption per hour	–	–	21000	30000	41000	68000	68000	100000

Permissible impact velocity:

Maximum permissible mass:

- v permissible impact speed
- E max. impact energy
- m_1 moving mass (drive)
- m_2 moving payload



Note

These specifications represent the maximum values that can be achieved. The maximum permissible impact energy must be observed.

Datasheet

DFM-B with plain-bearing guide GF, cushioning P, PPV								
Stroke [mm]	Piston \varnothing							
	12	16	20	25	32	40	50	63
Product weight [g]								
10	385	621	–	–	–	–	–	–
20	432	680	1026	1474	2163	–	–	–
25	452	706	1068	1530	2238	2606	4290	5568
30	476	736	1109	1586	2337	–	–	–
40	523	795	1215	1726	2489	–	–	–
50	570	854	1298	1838	2640	3047	5019	6457
80	712	1033	1572	2218	3210	3663	5909	7503
100	803	1148	1733	2435	3502	3981	6376	8116
125	962	1352	2000	2800	4018	4534	7151	9050
160	1128	1560	2293	3193	4549	5118	8017	10137
200	1318	1797	2628	3642	5158	5786	9007	11379
250	–	–	3237	4430	6259	6962	10813	13509
320	–	–	3823	5215	7322	8129	12545	15682
400	–	–	4493	6113	8537	9462	14525	18165
Moving mass [g]								
10	201	283	–	–	–	–	–	–
20	216	302	506	715	1147	–	–	–
25	223	312	520	734	1176	1305	2217	2640
30	230	322	534	753	1230	–	–	–
40	245	342	586	823	1289	–	–	–
50	260	362	615	861	1347	1476	2567	2990
80	304	423	724	1022	1644	1776	3002	3426
100	333	463	781	1098	1764	1893	3189	3613
125	420	579	917	1289	2059	2188	3586	4009
160	472	649	1016	1422	2264	2393	3913	4336
200	530	730	1129	1573	2499	2627	4286	4710
250	–	–	1489	2017	3164	3293	5351	5774
320	–	–	1688	2283	3574	3703	6005	6428
400	–	–	1914	2587	4042	4171	6752	7176

Datasheet

DFM-B with plain-bearing guide GF, cushioning P, PPV, variant S6								
Stroke [mm]	Piston ø							
	12	16	20	25	32	40	50	63
Product weight [g]								
0	283	488	745	1080	1594	1847	3124	3992
10	328	548	–	–	–	–	–	–
20	376	607	907	1298	1889	–	–	–
25	395	633	949	1354	1964	2257	3735	4762
30	419	663	990	1410	2063	–	–	–
40	466	722	1096	1550	2215	–	–	–
50	514	781	1179	1662	2366	2698	4464	5651
80	656	959	1452	2042	2936	3314	5354	6696
100	747	1074	1614	2259	3228	3632	5821	7310
125	905	1279	1880	2624	3745	4186	6596	8244
160	1072	1486	2173	3017	4276	4770	7462	9331
200	1261	1724	2508	3466	4884	5437	8452	10573
250	–	–	3118	4254	5985	6613	10258	12703
320	–	–	3704	5039	7048	7780	11990	14876
400	–	–	4374	5937	8264	9114	19970	17359
Moving mass [g]								
0	130	188	329	463	755	810	1428	1601
10	145	208	–	–	–	–	–	–
20	159	229	386	539	873	–	–	–
25	167	239	400	558	902	956	1662	1834
30	174	249	414	577	956	–	–	–
40	188	269	467	647	1015	–	–	–
50	203	289	495	685	1073	1127	2012	2184
80	247	349	604	847	1373	1427	2447	2620
100	276	389	661	922	1490	1544	2634	2806
125	364	506	797	1113	1785	1840	3031	3203
160	415	576	896	1246	1990	2045	3358	3530
200	474	657	1010	1397	2225	2279	3731	3904
250	–	–	1370	1842	2890	2944	4796	4968
320	–	–	1568	2107	3300	3354	5450	5622
400	–	–	1794	2411	3768	3823	6197	6370

Datasheet

DFM-B with recirculating ball bearing guide KF, cushioning P, PPV								
Stroke [mm]	Piston \varnothing							
	12	16	20	25	32	40	50	63
Product weight [g]								
10	345	543	–	–	–	–	–	–
20	388	596	935	1395	1932	–	–	–
25	405	619	974	1447	1998	2366	3907	5185
30	427	647	1012	1499	2079	–	–	–
40	470	700	1105	1624	2213	–	–	–
50	513	754	1181	1729	2346	2753	4523	5961
80	641	916	1428	2074	2817	3270	5272	6865
100	723	1020	1577	2276	3073	3552	5682	7423
125	852	1190	1809	2599	3490	4006	6327	8226
160	1002	1378	2079	2966	3958	4526	7094	9214
200	1174	1593	2388	3384	4494	5121	7971	10343
250	–	–	2905	4073	5369	6072	9419	12115
320	–	–	3445	4805	6305	7112	10953	14091
400	–	–	4063	5642	7376	8301	12707	16347
Moving mass [g]								
10	168	239	–	–	–	–	–	–
20	178	254	437	631	933	–	–	–
25	183	261	447	646	954	1082	1830	2254
30	188	268	458	661	990	–	–	–
40	198	283	498	716	1030	–	–	–
50	208	297	520	746	1071	1199	2067	2491
80	238	341	602	873	1271	1400	2361	2785
100	259	370	646	934	1352	1481	2492	2915
125	316	452	748	1083	1548	1677	2758	3182
160	352	503	824	1189	1690	1819	2986	3410
200	392	561	911	1310	1852	1981	3247	3671
250	–	–	1180	1656	2291	2420	3953	4377
320	–	–	1332	1868	2575	2703	4410	4833
400	–	–	1505	2111	2899	3027	4931	5355

Datasheet

Additional weights for precision stroke adjustment AJ – GF, KF

When using the precision stroke adjustment AJ, the following weight must be taken into account in addition to the mass specified from page 44.

Product weight [g] Precision stroke adjustment AJ (piston rod + stop)								
Stroke [mm]	Piston ø							
	12	16	20	25	32	40	50	63
10	55.4	58.8	–	–	–	–	–	–
20	57.6	61	75.6	115.4	185.7	–	–	–
25	58.7	62.1	77.6	118.5	190.2	188.7	350.7	350.5
30	59.9	63.3	79.6	121.6	194.7	–	–	–
40	62.1	65.5	83.6	127.8	203.6	–	–	–
50	64.3	67.7	87.5	134	212.5	211	390.4	390.2
80	71	74.4	99.5	152.6	239.3	237.8	438	437.8
100	75.5	78.9	107.5	165	257.2	255.7	469.8	469.6
125	81.1	84.5	117.3	180.5	279.5	278	509.5	509.3
160	88.9	92.3	131.2	202.5	310.8	309.3	565.1	564.9
200	97.8	101.2	147.1	227	346.5	345	628.6	628.4
250	–	–	167	258.1	391.2	389.7	708.1	707.9
320	–	–	194.8	301.5	453.8	452.3	819.2	819
400	–	–	226.5	351.1	525.2	523.7	946.3	946.1

Moving mass [g] Precision stroke adjustment AJ (piston rod + stop)								
Stroke [mm]	Piston ø							
	12	16	20	25	32	40	50	63
10	51.5	52.3	–	–	–	–	–	–
20	53.7	54.5	76	116.6	185.9	–	–	–
25	54.8	55.6	78	119.7	190.4	190	351.7	351.7
30	56	56.8	80	122.8	194.9	–	–	–
40	58.2	59	84	129	203.8	–	–	–
50	60.4	61.2	87.9	135.2	212.7	212.7	391.4	391.4
80	67.1	67.9	99.9	153.8	239.5	239.5	439	439
100	71.6	72.4	107.8	166.2	257.4	257.4	470.8	470.8
125	77.2	78	117.7	181.7	279.7	279.7	510.5	510.5
160	85	85.8	131.6	203.4	311	311	566.1	566.1
200	93.9	94.7	147.5	228.2	346.7	346.7	629.6	629.6
250	–	–	167.4	259.3	391.4	391.4	709.1	709.1
320	–	–	195.2	302.7	454	454	820.2	820.2
400	–	–	226.9	352.3	525.4	525.4	947.3	947.3

Datasheet

Additional weights for precision stroke adjustment EJ – GF, KF

When using the precision stroke adjustment EJ, the following weight must be taken into account in addition to the mass specified from page 44.

Product weight [g] Precision stroke adjustment EJ (piston rod + stop)						
Stroke [mm]	Piston ø					
	20	25	32	40	50	63
20	55.7	117.1	134.1	–	–	–
25	56.4	119.1	136.1	153.9	302.8	354
30	57.2	121	138	–	–	–
40	58.8	125	142	–	–	–
50	60.3	129	146	163.8	318.3	369.5
80	65	140.9	157.9	175.7	336.9	388.1
100	68.1	148.8	165.8	183.6	349.4	400.6
125	71.9	158.8	175.8	193.6	364.9	416.1
160	77.4	172.7	189.7	207.5	386.6	437.8
200	83.6	188.5	205.5	223.3	411.4	462.6
250	91.3	208.4	225.4	243.2	442.4	493.6
320	102.2	236.2	253.2	271	485.9	537.1
400	114.6	268	285	302.8	535.5	586.7

DFM-B with recirculating ball bearing guide KF, cushioning YSRW						
Stroke [mm]	Piston ø					
	20	25	32	40	50	63
Product weight [g]						
20	1684	2641	3717	–	–	–
25	1733	2707	3801	4995	7594	10816
30	1780	2773	3884	–	–	–
40	1874	2903	4053	–	–	–
50	1970	3035	4222	5455	8275	11657
80	2257	3429	4720	5999	9092	12629
100	2444	3687	5047	6352	9614	13298
125	2677	4008	5458	6801	10294	14137
160	3015	4473	6050	7446	11255	15319
200	3401	5004	6728	8183	12354	16670
250	3855	5641	7545	9074	13700	18340
320	4530	6569	8730	10363	15623	20704
400	5302	7631	10085	11837	17821	23405
Moving mass [g]						
20	874	1323	1933	–	–	–
25	894	1350	1969	2386	3735	4996
30	914	1378	2005	–	–	–
40	953	1432	2077	–	–	–
50	993	1487	2149	2566	4021	5282
80	1111	1650	2365	2782	4365	5625
100	1190	1759	2509	2926	4594	5855
125	1289	1896	2690	3106	4880	6141
160	1427	2087	2942	3359	5281	6542
200	1585	2305	3230	3647	5739	7000
250	1782	2578	3590	4007	6312	7572
320	2059	2959	4095	4512	7114	8374
400	2375	3396	4671	5088	8030	9290

Datasheet

Materials			
Guided drive	Plain-bearing guide GF	Recirculating ball bearing guide KF	S6
Housing	Anodised wrought aluminium alloy	Anodised wrought aluminium alloy	Anodised wrought aluminium alloy
Yoke plate	Quenched and tempered steel	Quenched and tempered steel	Wrought aluminium alloy
Bearing and end caps	Anodised wrought aluminium alloy	Anodised wrought aluminium alloy	Anodised wrought aluminium alloy
Piston rod	High-alloy stainless steel	High-alloy stainless steel	High-alloy stainless steel
Guide rods	High-alloy steel	Quenched and tempered steel, hard-chrome plated	High-alloy steel
Static seals	Nitrile rubber	Nitrile rubber	Fluoro rubber
Dynamic seals	Polyurethane	Polyurethane	Fluoro rubber
Note on materials	RoHS-compliant		
LABS (PWIS) conformity	VDMA24364-B1/B2-L		
CE marking (see declaration of conformity)	To EU Explosion Protection Directive (ATEX)		
UKCA marking (see declaration of conformity)	To UK explosion regulations		

Datasheet

Maximum payload F [N]

Plain-bearing guide GF and recirculating ball bearing guide KF

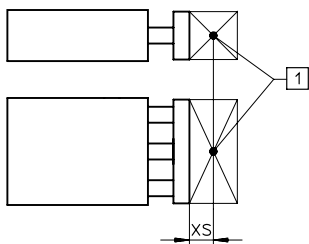

[1] Centre of gravity of payload

Piston \varnothing	12	16	20	25	32	40	50	63
XS [mm]	25	50	50	50	50	50	50	50

Stroke [mm]		Piston \varnothing							
		12	16	20	25	32	40	50	63
10	GF	53	95	–	–	–	–	–	–
	KF	47	75	–	–	–	–	–	–
20	GF	47	86	99	121	188	–	–	–
	KF	42	69	80	88	120	–	–	–
25	GF	45	83	96	116	180	180	257	257
	KF	40	66	77	86	118	118	182	182
30	GF	43	79	92	112	173	–	–	–
	KF	38	64	75	84	116	–	–	–
40	GF	39	73	110	123	161	–	–	–
	KF	35	58	91	100	112	–	–	–
50	GF	36	67	103	115	150	150	216	216
	KF	32	56	88	97	109	109	168	168
80	GF	28	55	86	96	166	166	234	234
	KF	26	51	80	89	134	134	201	201
100	GF	25	49	77	86	150	150	212	212
	KF	23	48	75	85	128	128	193	193
125	GF	23	37	71	86	168	168	229	229
	KF	20	30	65	80	144	144	211	211
160	GF	20	30	63	76	146	146	200	200
	KF	16	21	56	66	135	135	199	199
200	GF	15	25	55	67	127	127	174	174
	KF	13	17	47	56	126	126	188	188
250	GF	–	–	47	53	106	106	145	145
	KF	–	–	40	46	135	135	179	179
320	GF	–	–	41	45	91	91	124	124
	KF	–	–	34	38	125	125	158	158
400	GF	–	–	35	39	78	78	105	105
	KF	–	–	29	32	100	100	130	130



Note

Engineering tool

→ www.festo.com/engineeringtools

Datasheet

Permissible torque load M [Nm]

Plain-bearing guide GF and recirculating ball bearing guide KF

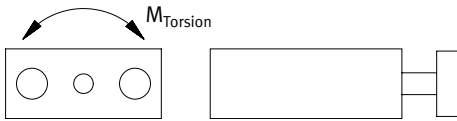

Stroke [mm]		Piston \varnothing							
		12	16	20	25	32	40	50	63
10	GF	1.09	2.19	–	–	–	–	–	–
	KF	0.96	1.73	–	–	–	–	–	–
20	GF	0.96	1.98	2.87	4.15	7.30	–	–	–
	KF	0.86	1.59	2.32	3.00	4.70	–	–	–
25	GF	0.92	1.91	2.78	3.95	7.00	7.90	14.15	15.90
	KF	0.82	1.52	2.23	2.92	4.60	5.20	10.00	11.30
30	GF	0.88	1.82	2.67	3.80	6.70	–	–	–
	KF	0.78	1.47	2.18	2.85	4.55	–	–	–
40	GF	0.80	1.68	3.19	4.20	6.20	–	–	–
	KF	0.72	1.33	2.64	3.40	4.40	–	–	–
50	GF	0.74	1.54	2.99	3.90	5.80	6.55	11.85	13.30
	KF	0.66	1.29	2.55	3.30	4.25	4.80	9.30	10.50
80	GF	0.57	1.27	2.49	3.25	6.40	7.25	12.85	14.45
	KF	0.53	1.17	2.32	3.02	5.25	5.90	11.00	12.50
100	GF	0.51	1.13	2.23	2.90	5.80	6.55	11.65	13.10
	KF	0.47	1.10	2.18	2.89	5.00	5.65	10.60	12.00
125	GF	0.47	0.85	2.06	2.90	6.50	7.35	12.55	14.10
	KF	0.41	0.69	1.89	2.70	5.60	6.35	11.60	13.20
160	GF	0.41	0.69	1.83	2.60	5.70	6.40	11.00	12.30
	KF	0.33	0.48	1.62	2.20	5.25	5.95	11.00	12.40
200	GF	0.31	0.58	1.60	2.30	5.00	5.55	9.60	10.70
	KF	0.27	0.39	1.36	1.90	4.90	5.55	10.30	11.70
250	GF	–	–	1.36	1.80	4.10	4.60	7.98	9.06
	KF	–	–	1.16	1.50	5.20	5.95	9.82	11.16
320	GF	–	–	1.19	1.50	3.50	4.00	6.82	7.75
	KF	–	–	0.99	1.30	4.80	5.50	8.67	9.85
400	GF	–	–	1.02	1.30	3.00	3.40	5.78	6.56
	KF	–	–	0.84	1.10	3.90	4.40	7.17	8.15

Torsional backlash ρ

Plain-bearing guide GF and recirculating ball bearing guide KF in retracted state, unloaded

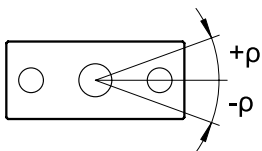

Piston \varnothing		12	16	20	25	32	40	50	63
Average torsional backlash [°]	GF	±0.03	±0.04	±0.03	±0.02	±0.03	±0.02	±0.02	±0.02
Torsional backlash [°]	KF	±0.03	±0.02	±0.02	±0.02	±0.01	±0.01	±0.02	±0.02

Datasheet

Deflection of the end plate

Average deflection f_1 due to bearing clearance as a function of stroke l (with no load)

DFM-GF with 2 bearings per guide rod

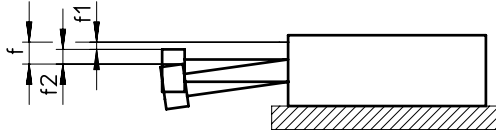

$f = f_1 + f_2$

f = total deflection of the end plate

f_1 = deflection due to average bearing clearance with production tolerance ± 0.01 mm

f_2 = deflection due to transverse force

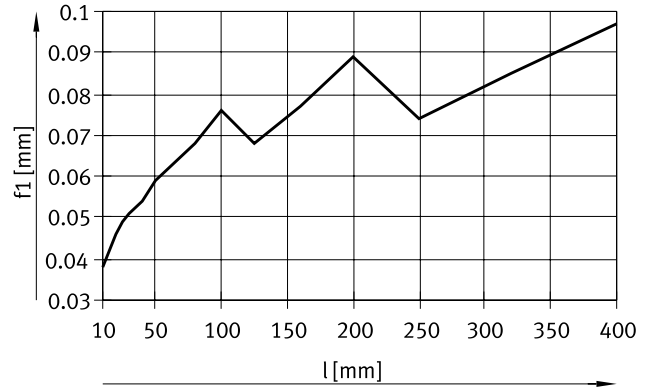

Deflection f_2 due to transverse force F as a function of the stroke with plain-bearing guide GF

Stroke 50 mm

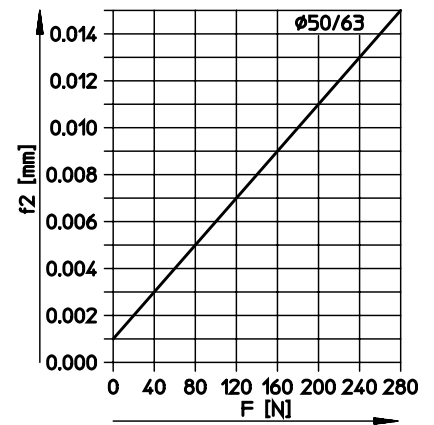
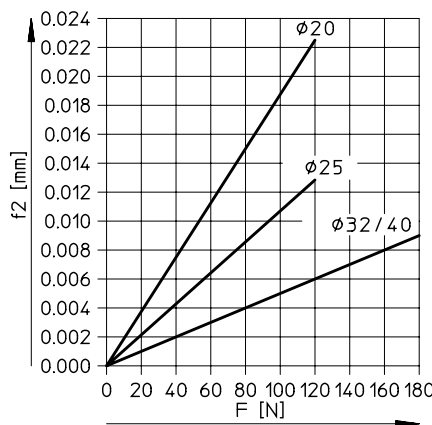
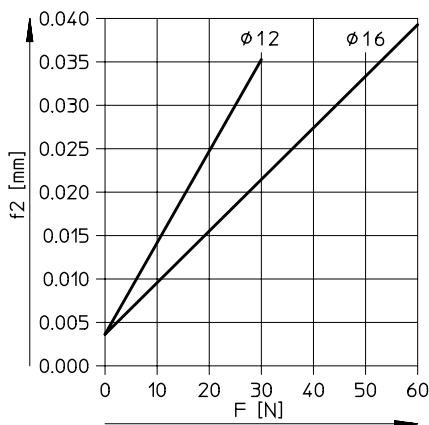

100 mm stroke

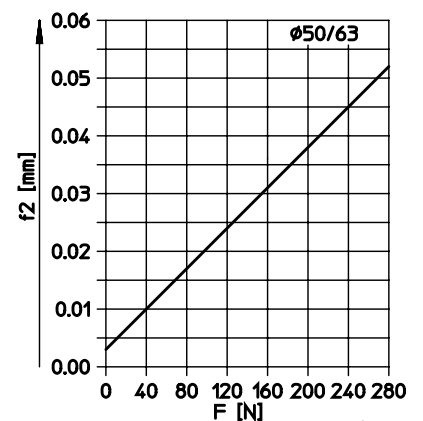
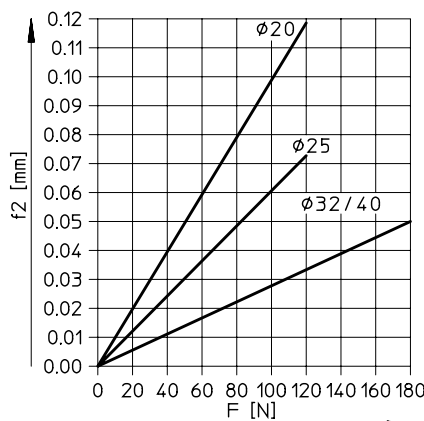
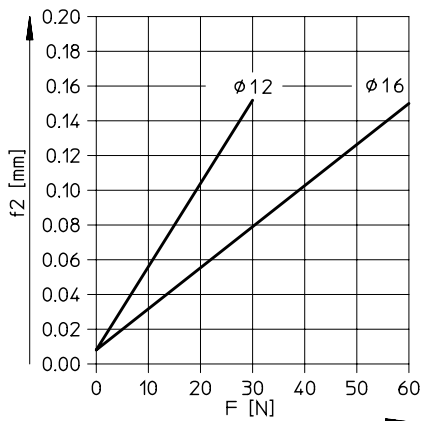

Datasheet

Deflection of the end plate

Average deflection f_1 due to bearing clearance as a function of stroke l (with no load)

DFM-GF with 2 bearings per guide rod

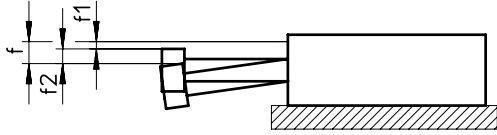

$$f = f_1 + f_2$$

f = total deflection of the end plate

f_1 = deflection due to average bearing clearance with production tolerance ± 0.01 mm

f_2 = deflection due to transverse force

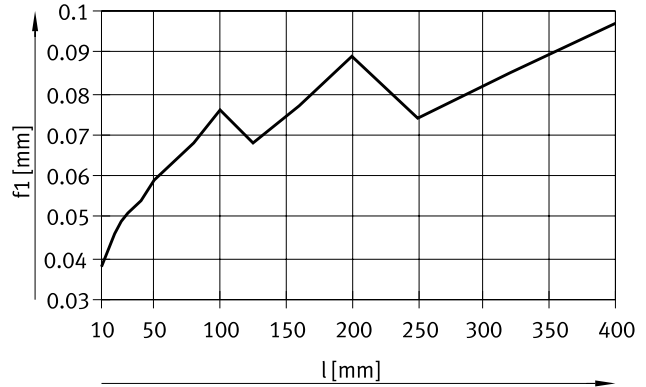

Deflection f_2 due to transverse force F as a function of the stroke with plain-bearing guide GF

200 mm stroke

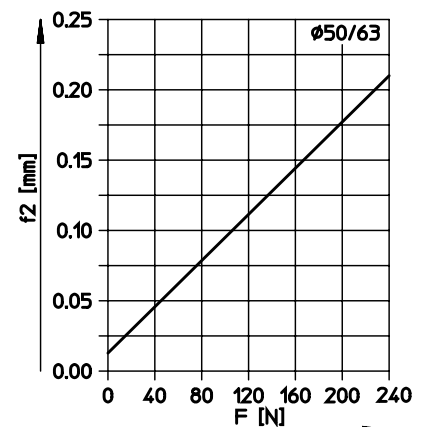
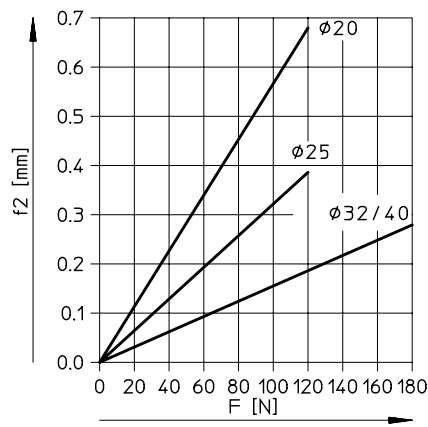
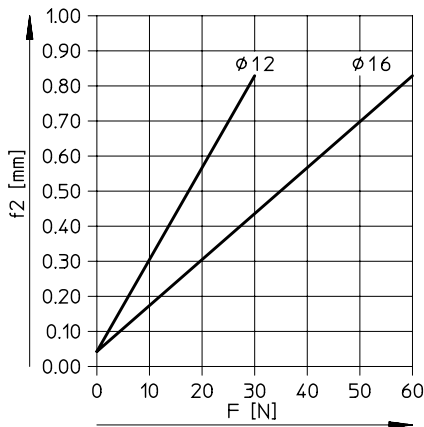

400 mm stroke

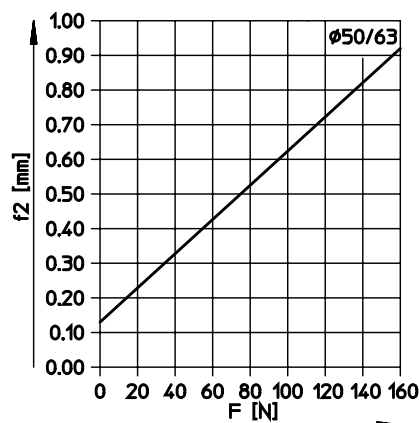
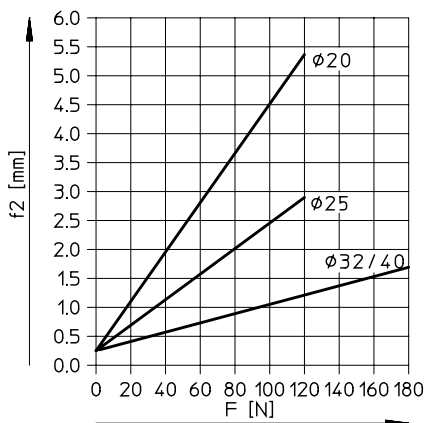

Datasheet

Deflection of the end plate

Deflection f_1 due to bearing clearance as a function of stroke l (with no load)

DFM-KF with 2 bearings per guide rod

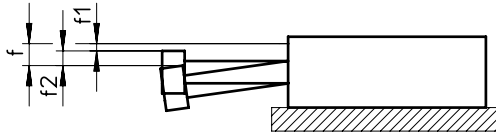

$f = f_1 + f_2$

f = total deflection of the end plate

f_1 = deflection due to average bearing clearance with production tolerance ± 0.01 mm

f_2 = deflection due to transverse force

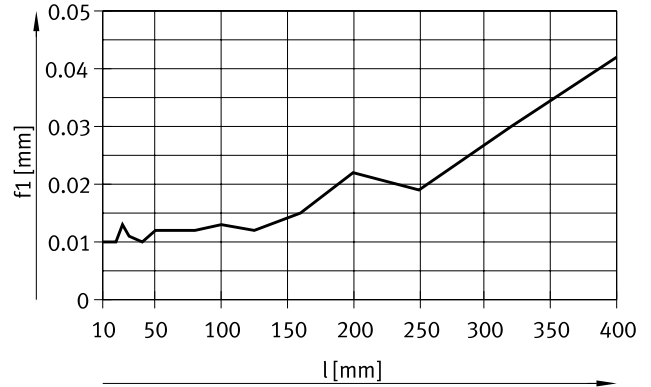

Deflection f_2 due to transverse force F as a function of the stroke with recirculating ball bearing guide KF

Stroke 50 mm

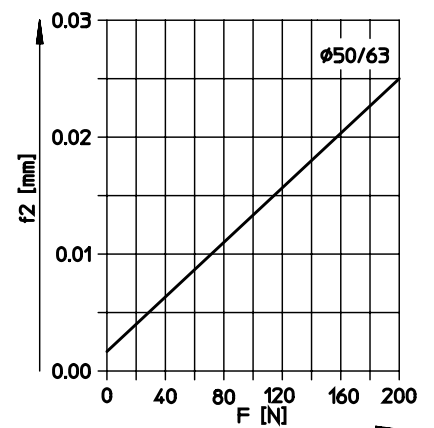
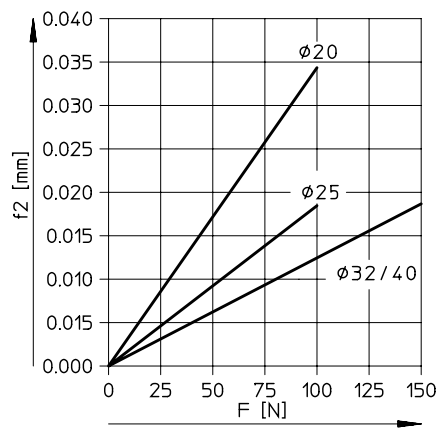
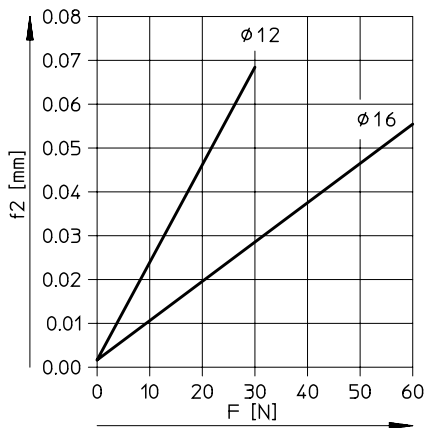

100 mm stroke

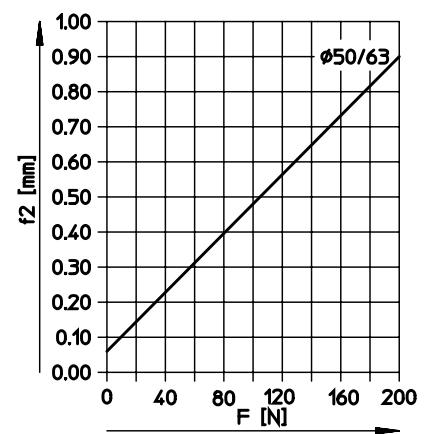
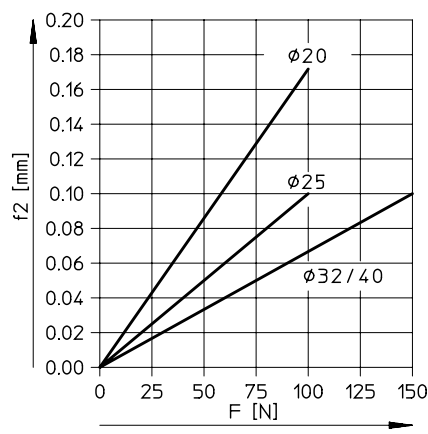
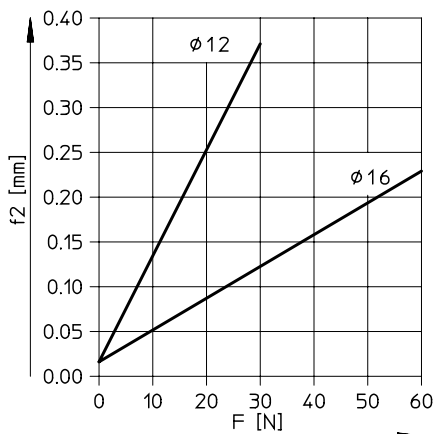

Datasheet

Deflection of the end plate

Deflection f_1 due to bearing clearance as a function of stroke l (with no load)

DFM-KF with 2 bearings per guide rod

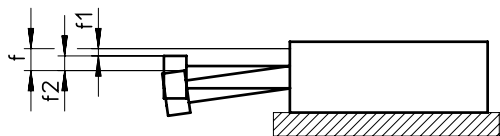

- $f = f_1 + f_2$
- f = total deflection of the end plate
- f_1 = deflection due to average bearing clearance with production tolerance ± 0.01 mm
- f_2 = deflection due to transverse force

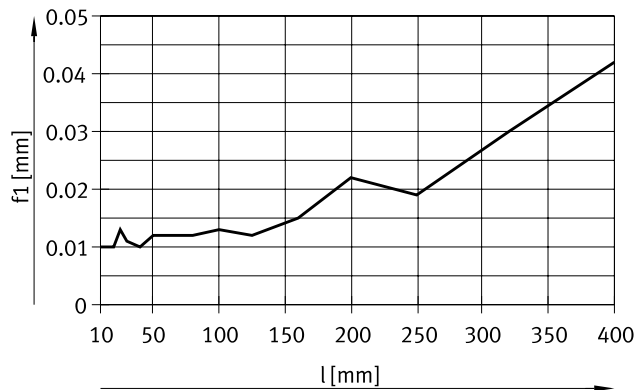

Deflection f_2 due to transverse force F as a function of the stroke with recirculating ball bearing guide KF

200 mm stroke

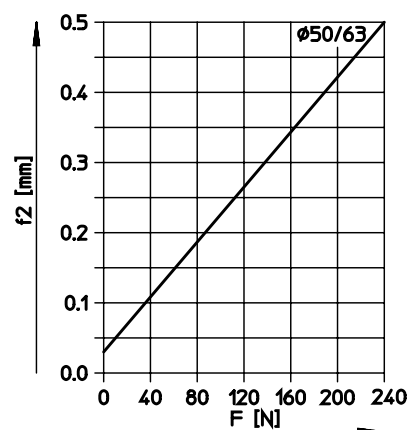
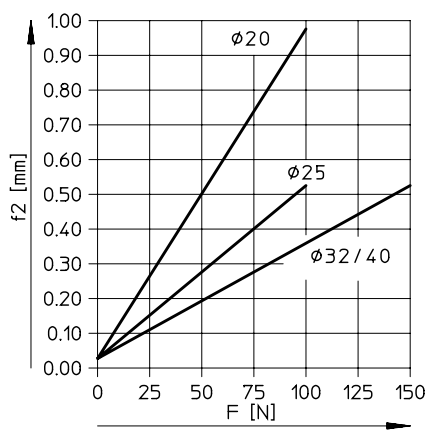
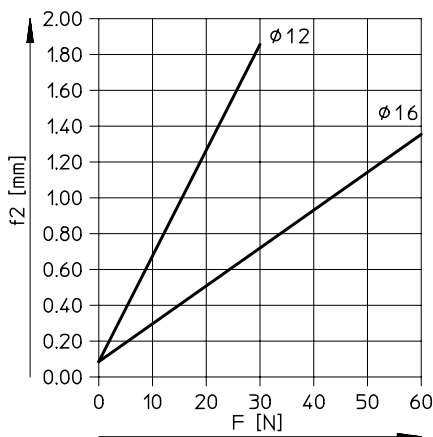

400 mm stroke

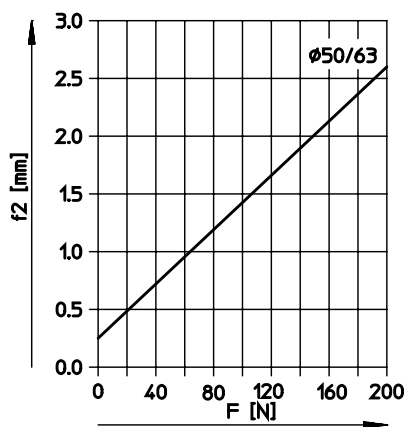
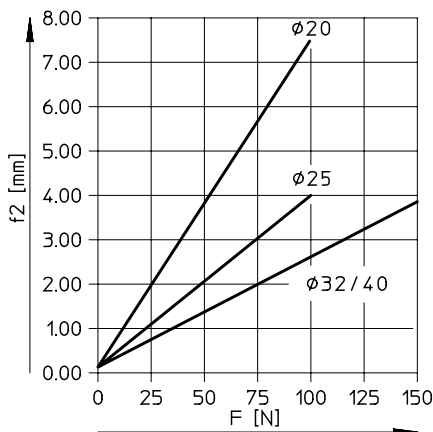

Datasheet

Use as a lifting cylinder

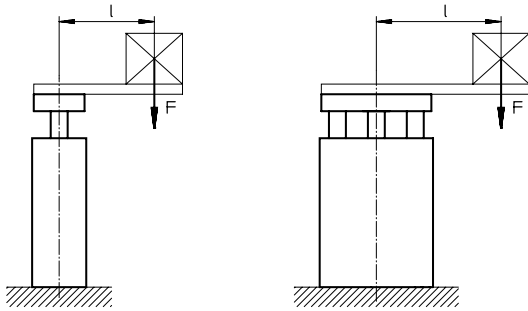

Permissible eccentric load at 0.6 MPa (6 bar, 87 psi):

Piston ϕ	12	16	20	25	32	40	50	63
Load	[N]	27	48	85	133	241	415	935

Permissible eccentric load at different pressure:

Piston ϕ	12	16	20	25	32	40	50	63
Load	[%]	$\leq 40^{1)}$	$\leq 50^{1)}$				$\leq 60^{1)}$	

1) The theoretical transverse force at the corresponding pressure

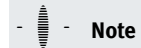

Note
Additional graphs
→ from page 16

F = longitudinal force [N]
l = lever arm [mm]

Permissible load with plain-bearing guide GF

Stroke 40 ... 400 mm

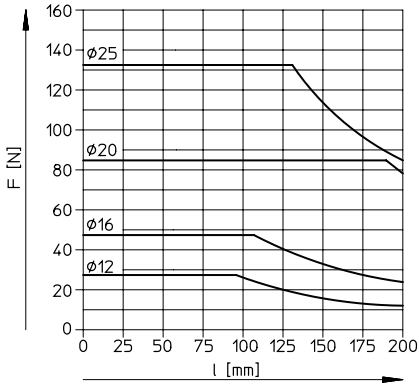

Stroke 250 ... 400 mm

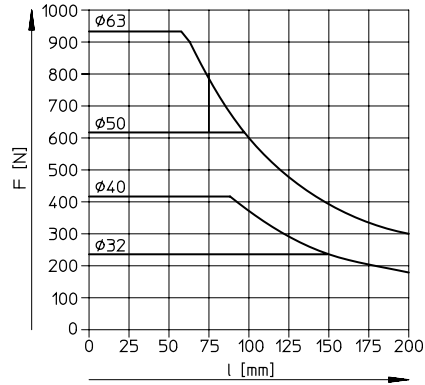

Permissible load with recirculating ball bearing guide KF

Stroke 40 ... 100 mm

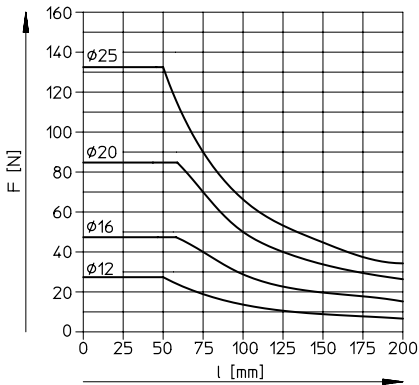

Stroke 125 ... 200 mm

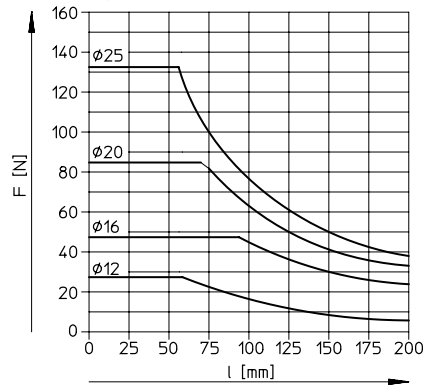

Stroke 250 ... 400 mm

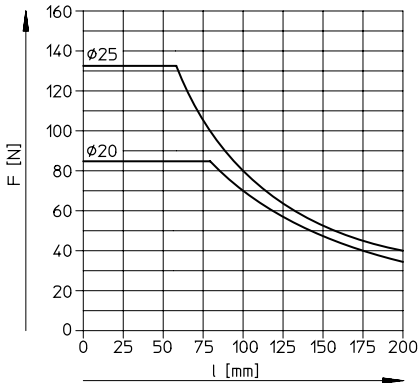

Stroke 200 ... 400 mm

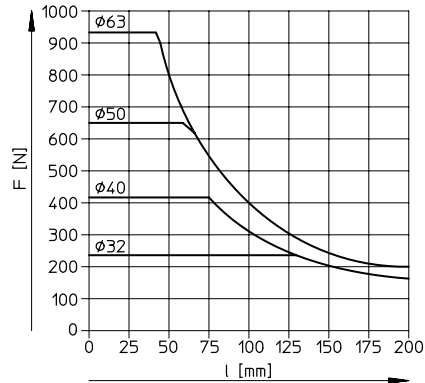

Datasheet

Permissible load mass m as a function of the permissible speed v

Horizontal operation, cushioning YSRW

DFM-20-...-B-YSRW

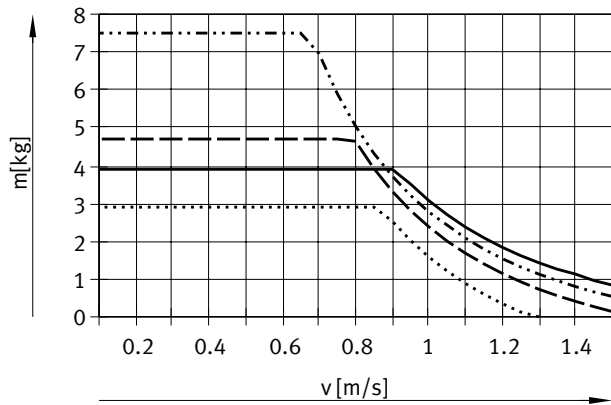

DFM-25-...-B-YSRW

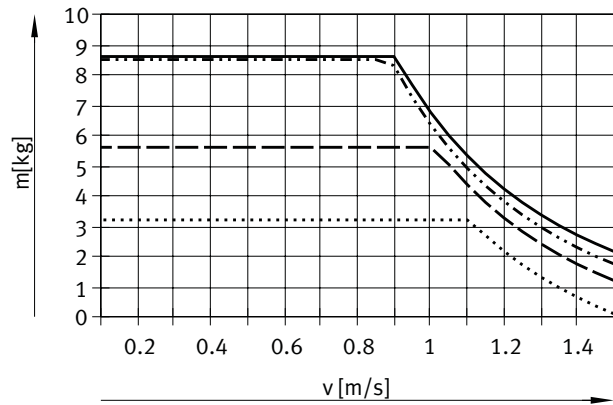

DFM-32-...-B-YSRW

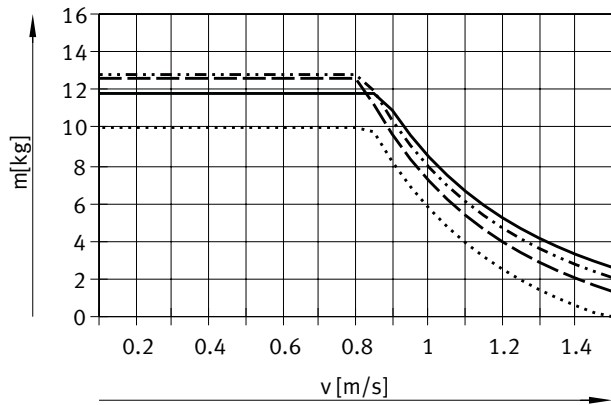

DFM-40-...-B-YSRW

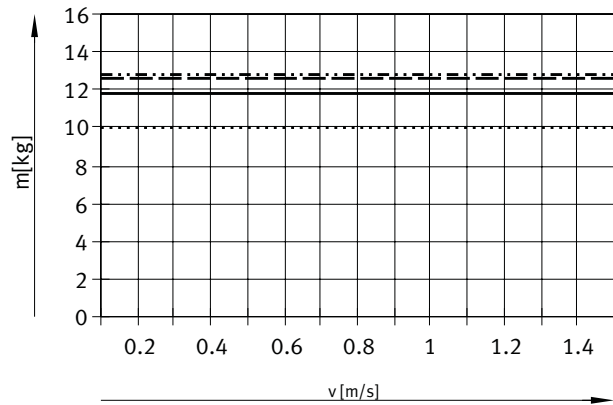

DFM-50-...-B-YSRW

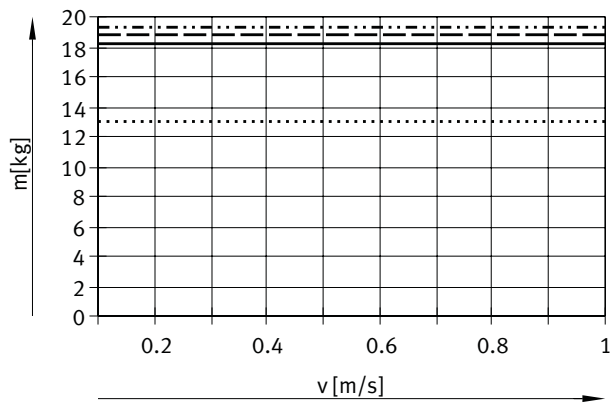

DFM-63-...-B-YSRW

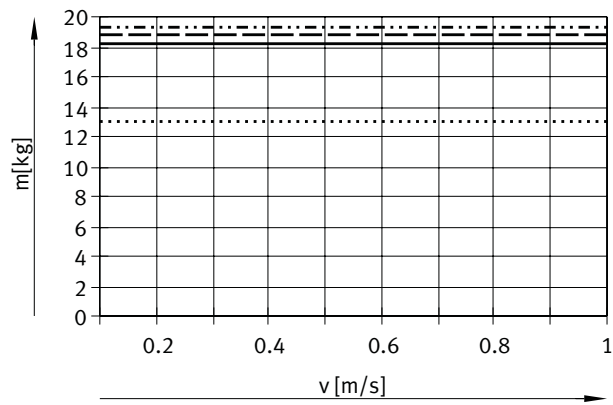

- Stroke 25 mm
- · - · - Stroke 100 mm
- - - Stroke 200 mm
- · · · · Stroke 400 mm

Datasheet

Permissible load mass m as a function of the permissible speed v

Vertical operation, cushioning YSRW

DFM-20-...-B-YSRW

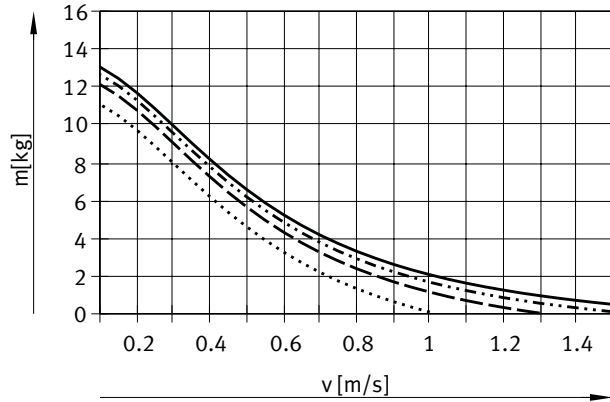

DFM-25-...-B-YSRW

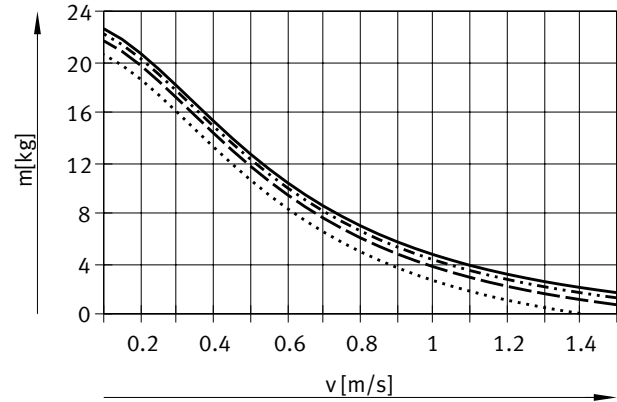

DFM-32-...-B-YSRW

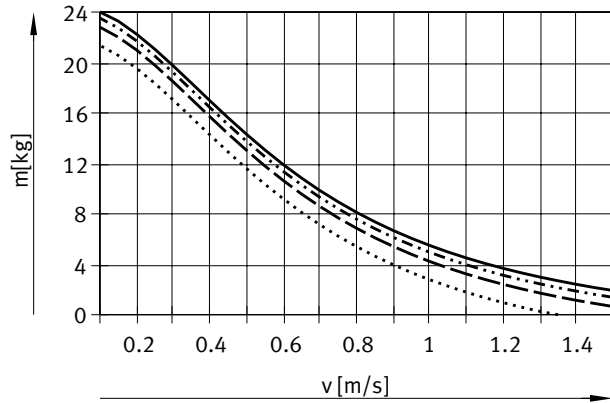

DFM-40-...-B-YSRW

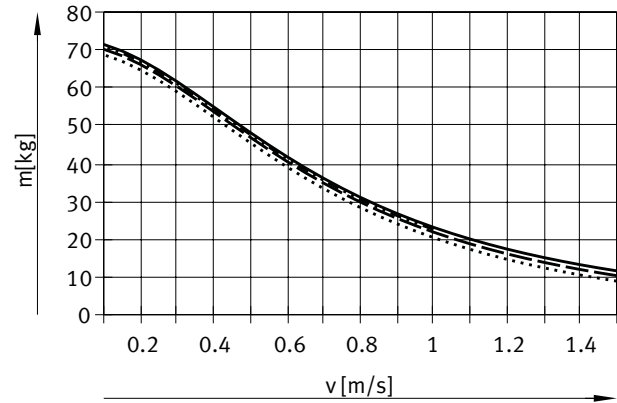

DFM-50-...-B-YSRW

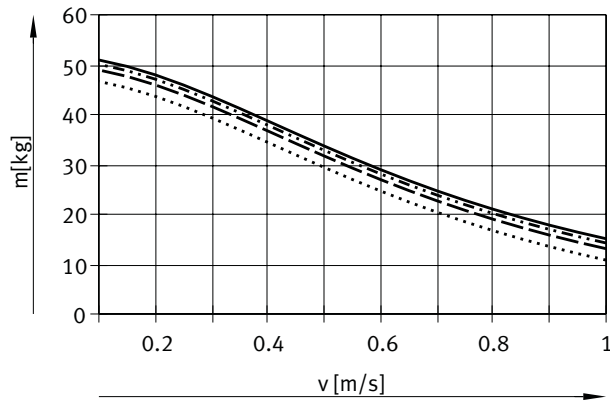

DFM-63-...-B-YSRW

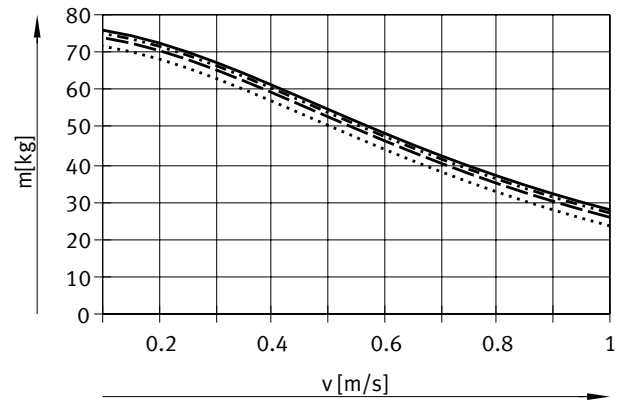

- Stroke 25 mm
- · - · - Stroke 100 mm
- - - - - Stroke 200 mm
- · · · · Stroke 400 mm

Datasheet

Dimensions

∅ 12, 16 mm

Download CAD data → www.festo.com

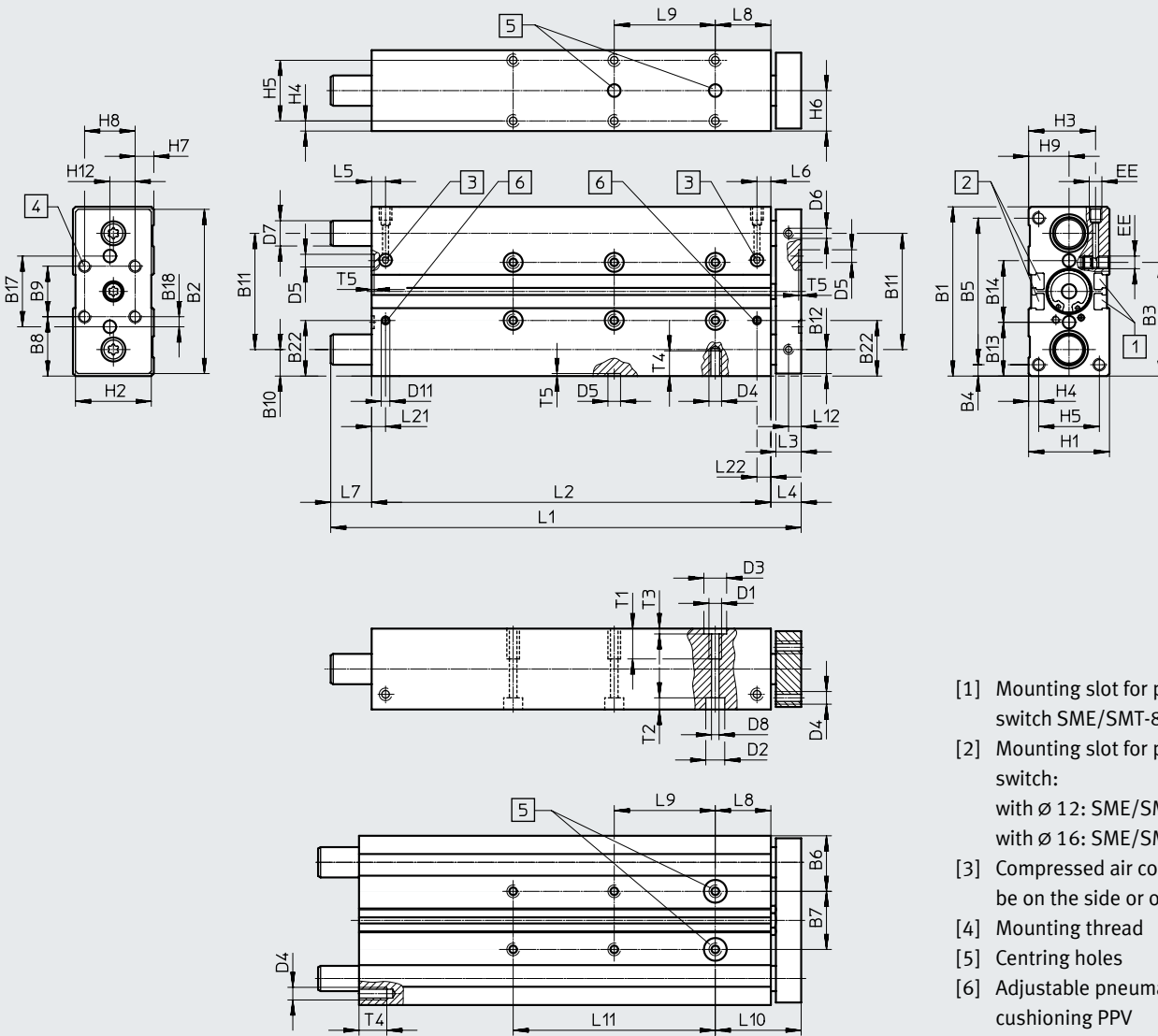

- [1] Mounting slot for proximity switch SME/SMT-8
- [2] Mounting slot for proximity switch:
with ∅ 12: SME/SMT-10
with ∅ 16: SME/SMT-8
- [3] Compressed air connection can be on the side or on top
- [4] Mounting thread
- [5] Centring holes
- [6] Adjustable pneumatic cushioning PPV

∅	B1	B2	B3	B4	B5	B6	B7	B8	B9	B10	B11	B12	B13	B14	B17	B18	B22
[mm]							±0.02 ¹⁾							±0.02 ¹⁾			
12	60	58	41	4.5	51	20.5	19	20	20	9.5	41	8.5	19.5	21	25	2.5	-
16	67	65	45	4.5	58	22	23	23.5	20	10.5	46	9.5	21.3	24.4	28	4	22.5

1) Tolerance between the centring holes

∅	D1	D2 ∅	D3 ∅	D4	D5 ∅	D6 ∅	D7 ∅		D8 ∅	D11 ∅	EE	H1	H2	H3	H4	H5	H6
							GF	KF									
[mm]			H8		H8				H8								
12	M5	8	9	M4	5	M4	10 _{h8}	8 _{h6}	4.3	-	M5	28	26	24	4	20	14
16	M5	7.5	9	M5	5	M4	12 _{h8}	10 _{h6}	4.3	3.3	M5	32	30	26.5	4	24	16

∅	H7	H8	H9	H12	L3	L4	L5	L6	L8	L10	L12	L21	L22	T1	T2	T3	T4	T5
[mm]																		
12	4	20	14	10	10	13	14.6	10.8	21	34	5	-	-	10	9.4	2.1	8	1.2
16	7.4	20	16	10	10	12	9.8	9.3	22	34	5	9.8	9.3	12	4.6	2.1	10	1.2

Datasheet

Stroke [mm]	Piston \varnothing [mm]					Piston \varnothing [mm]				
	12					16				
	L1	L2	L7	L9 $\pm 0.02^{1)}$	L11	L1	L2	L7	L9 $\pm 0.02^{1)}$	L11
10	74	50	11	–	–	80	68	–	–	–
20	84	60	11	–	–	90	78	–	–	–
25	89	65	11	20	–	95	83	–	20	–
30	94	70	11	20	–	100	88	–	20	–
40	104	80	11	20	–	110	98	–	20	–
50	114	90	11	40	–	120	108	–	40	–
80	144	120	11	40	–	150	138	–	40	–
100	164	140	11	40	80	170	158	–	40	80
125	230	165	52	40	80	229	183	34	40	80
160	265	200	52	40	120	264	218	34	40	120
200	305	240	52	40	160	304	258	34	40	160

1) Tolerance between the centring holes

Note

If the guide rods project beyond the housing when the unit is in its retracted end position (\rightarrow dimension L7), a recess must be provided in the mounting surface if the unit is to be mounted on the end face so that the guide rods can move freely.

When using a variable stroke, dimensions L1, L2, L7, L9 and L11 correspond to the next longest standard stroke.

Dimensions Download CAD data \rightarrow www.festo.com

AJ – Precision stroke adjustment in the advanced end position
 \varnothing 12, 16 mm

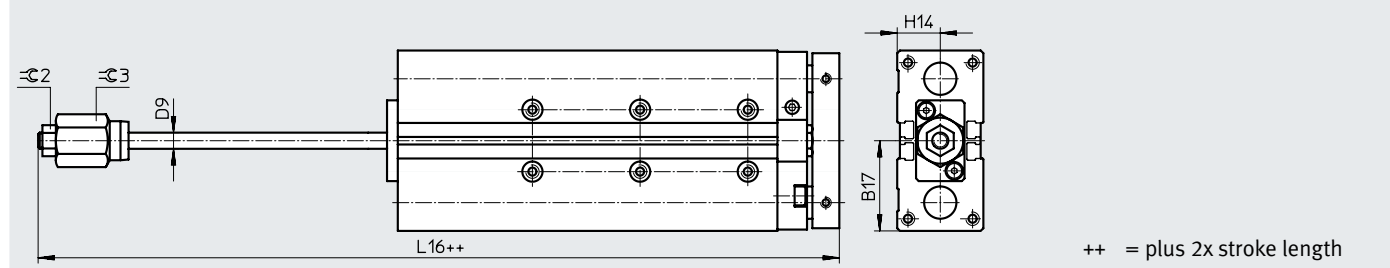

\varnothing	B17	D9 \varnothing	H14	L16	$\approx C2$	$\approx C3$
12	30.5	6	14	90.6	10	17
16	33.5	6	16	107.9	10	17

Datasheet

Dimensions

∅ 20 ... 40 mm

Download CAD data → www.festo.com

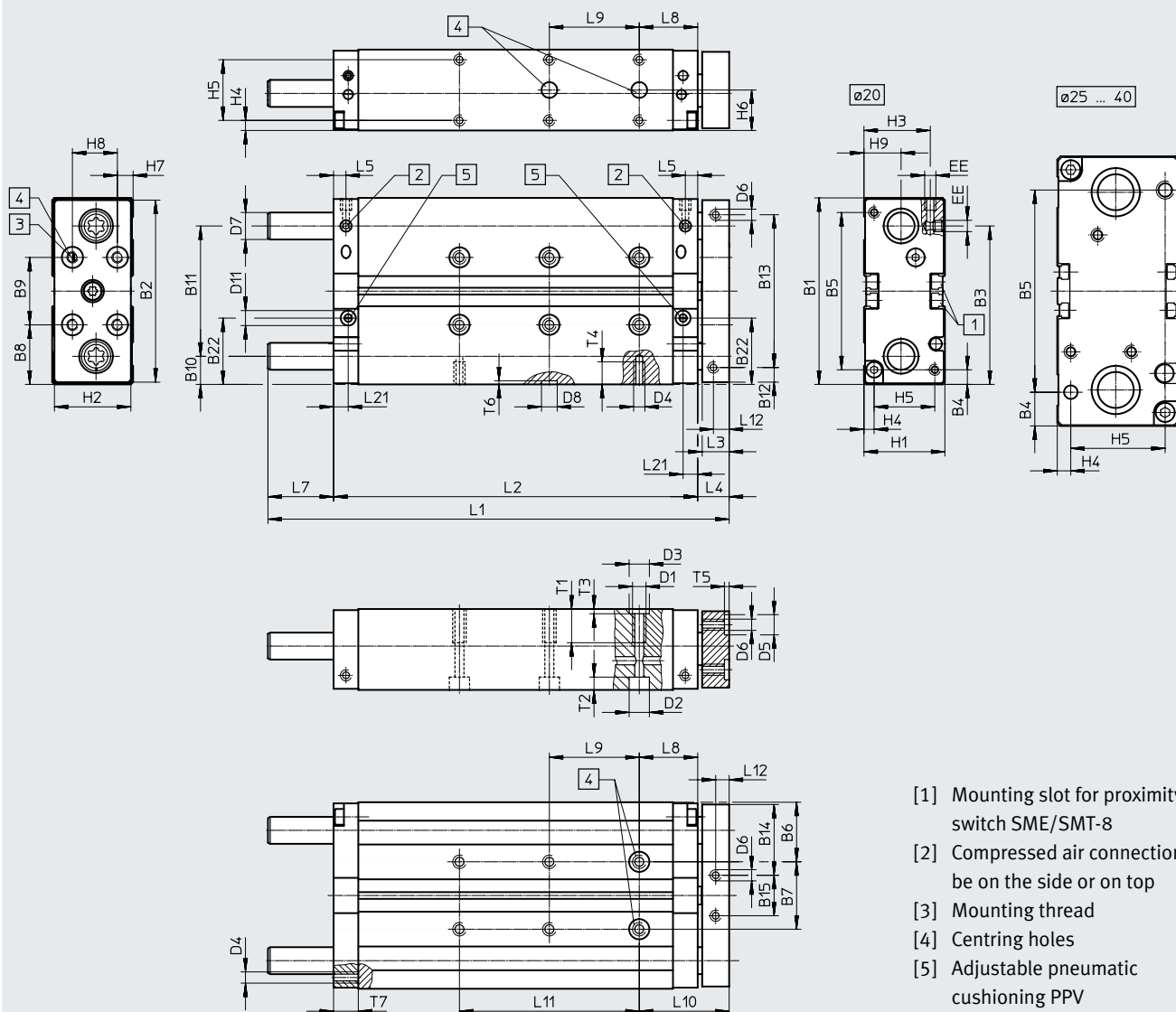

- [1] Mounting slot for proximity switch SME/SMT-8
- [2] Compressed air connection can be on the side or on top
- [3] Mounting thread
- [4] Centring holes
- [5] Adjustable pneumatic cushioning PPV

Datasheet

∅	B1	B2	B3	B4	B5	B6	B7	B8	B9	B10	B11	B12	B13	B14	B15	B22	D1
[mm]							±0.02 ¹⁾		±0.02 ¹⁾								
20	83	81	70	6.5	70	26.5	30	26.5	30	12.5	58	6.5	68	31.5	18	28	M6
25	95	93	69	15.5	64	30	35	27.5	40	13.5	68	12.5	68	32.5	28	32	M6
32	110	108	79.5	20	70	33.5	43	35	40	16	78	15	78	41	26	38	M8
40	120.5	118	85.5	15	90	34.5	51	35	50	16	88	15	88	41	36	41.5	M8

1) Tolerance between the centring holes

∅	D2 ∅	D3 ∅ H8	D4	D5 ∅ H8	D6 ∅	D7 ∅		D8 ∅ H8	D11 ∅	EE	H1	H2	H3	H4	H5	H6	H7
						GF	KF										
20	9	9	M5	9	M5	14	12	7	8.5	M5	36	34	28.5	4.5	27	18	7
25	9	9	M6	9	M6	16	14	7	8.8	G1/8	44	42	34	4.5	35	22	12
32	11	12	M6	9	M6	20	16	9	8.8	G1/8	49	47	37	6	37	24.5	8.5
40	11	12	M8	9	M6	20	16	9	8.8	G1/8	54	52	41.5	6	42	27	10

∅	H8	H9	L3	L4	L5	L8	L10	L12	L21	T1	T2	T3	T4	T5	T6	T7
[mm]																
20	20	16.5	12	14	6	26	40	6	6	12	5.7	2.1	10	2.1	1.6	11
25	20	19	12	14	8.5	26	40	6	8	12	5.7	2.1	12	2.1	1.6	15
32	30	21	14	16	8.5	29	45	7	9	20	6.8	2.6	11	2.1	2.1	15
40	30	26	14	16	8.5	29	45	7	9.5	20	6.8	2.6	16	2.1	2.1	15

Stroke [mm]	Piston ∅ [mm]																						
	20					25					32					40							
	L1	L2	L7	L9 ±0.02 ¹⁾	L11	L1	L2	L7	L9 ±0.02 ¹⁾	L11	L1	L2	L7	L9 ±0.02 ¹⁾	L11	L1	L2	L7	L9 ±0.02 ¹⁾	L11			
20	105	82	9	20	-	111	90	7	20	-	118	95	7	20	-	-	-	-	-	-			
25	110	87				116	95				123	100				123	101	6	20				
30	115	92				121	100				133	105				-	-	-	-				
40	135	102	19	-	-	141	110	17	-	-	143	115	12	-	-	153	125	153	126	11	-		
50	145	112				151	120				153	125				208	155	208	156	36			
80	185	142	29	-	-	196	150	32	-	-	228	175	37	-	-	228	176	208	156	36	-		
100	205	162				216	170				228	175				228	176	208	156				
125	257	187	56	80	-	271	195	62	-	80	283	200	67	40	-	283	201	228	176	208	156	36	80
160	292	222				120	306				230	120				318	235	120	318	236	66	40	120
200	332	262	146	40	-	160	346	270	142	-	160	358	275	142	-	160	358	276	200	483	326	200	160
250	472	312				200	476	320			200	483	325			200	483	326	200	483	326	200	
320	542	382				240	546	390			240	553	395			240	553	396	141	240	553	396	240
400	622	462	320	626	470	320	633	475	320	633	476	320	633	476	320								

1) Tolerance between the centring holes

‡ Note: This product conforms to ISO 1179-1 and ISO 228-1.

Note

If the guide rods project beyond the housing when the unit is in its retracted end position (→ dimension L7), a recess must be provided in the mounting surface if the unit is to be mounted on the end face so that the guide rods can move freely.

When using a variable stroke, dimensions L1, L2, L7, L9 and L11 correspond to the next longest standard stroke.

Datasheet

Dimensions

Download CAD data → www.festo.com

YSRW – self-adjusting cushioning
 ∅ 20 ... 40 mm

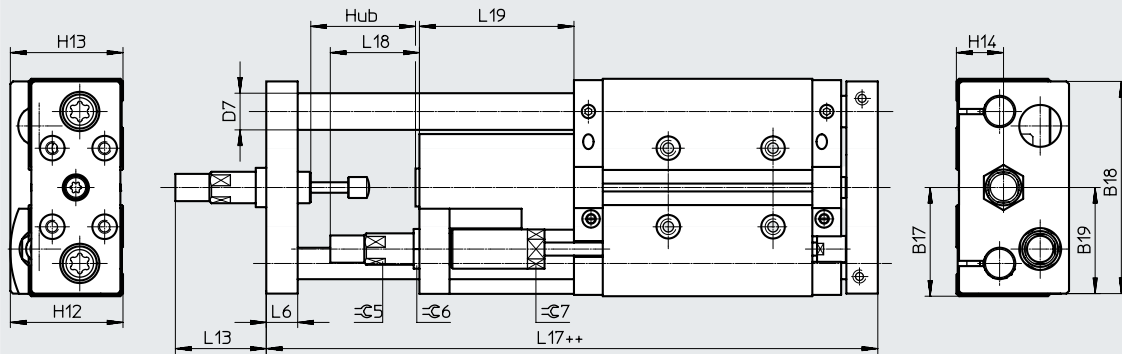

++ = plus 2x stroke length

AJ/EJ – Precision stroke adjustment in the advanced and retracted end position
 ∅ 20 ... 40 mm

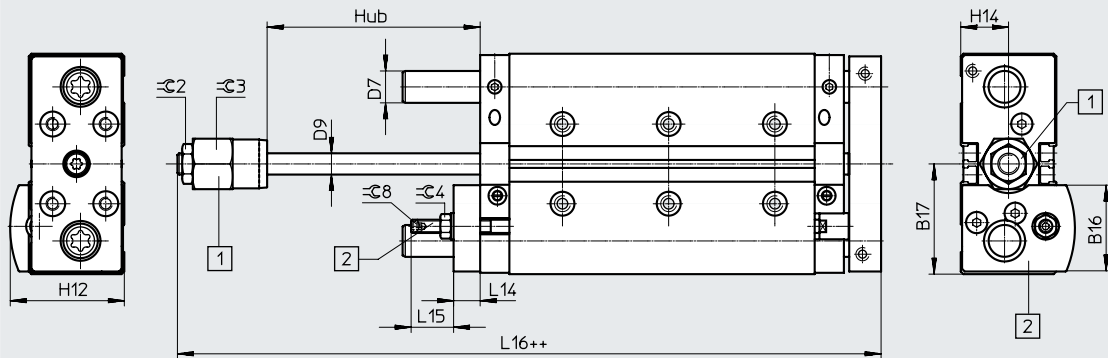

[1] Variant AJ

[2] Variant EJ

++ = plus 2x stroke length

Datasheet

∅ [mm]	B16	B17	B18	B19	D7 ∅		D9 ∅	H12	H13	H14	L6	L13	L14
					GF	KF							
20	32.5	41.5	81	40.5	14	12	8	43	43	18	12	36.5	10
25	38.6	47.5	90	45	16	14	10	49.5	50.5	22	14	43	12
32	43.4	55	105	52.5	20	16	12	56.5	56	24.5	16	52	12
40	46.2	60	116	58	20	16	12	62.5	63.5	27	16	72	12

∅ [mm]	L15	L16	L17	L18	L19	≈C2	≈C3	≈C4	≈C5	≈C6	≈C7	≈C8
25	23.5	119.5	176.5	37.5	71	17	24	13	13	17	16	4
32	18.5	129.5	190.5	48.5	76	17	30	13	15	17	19	4
40	18.5	132	209.5	55.5	95	17	30	13	20	22	27	4

Datasheet

Dimensions

∅ 50 ... 63 mm

Download CAD data → www.festo.com

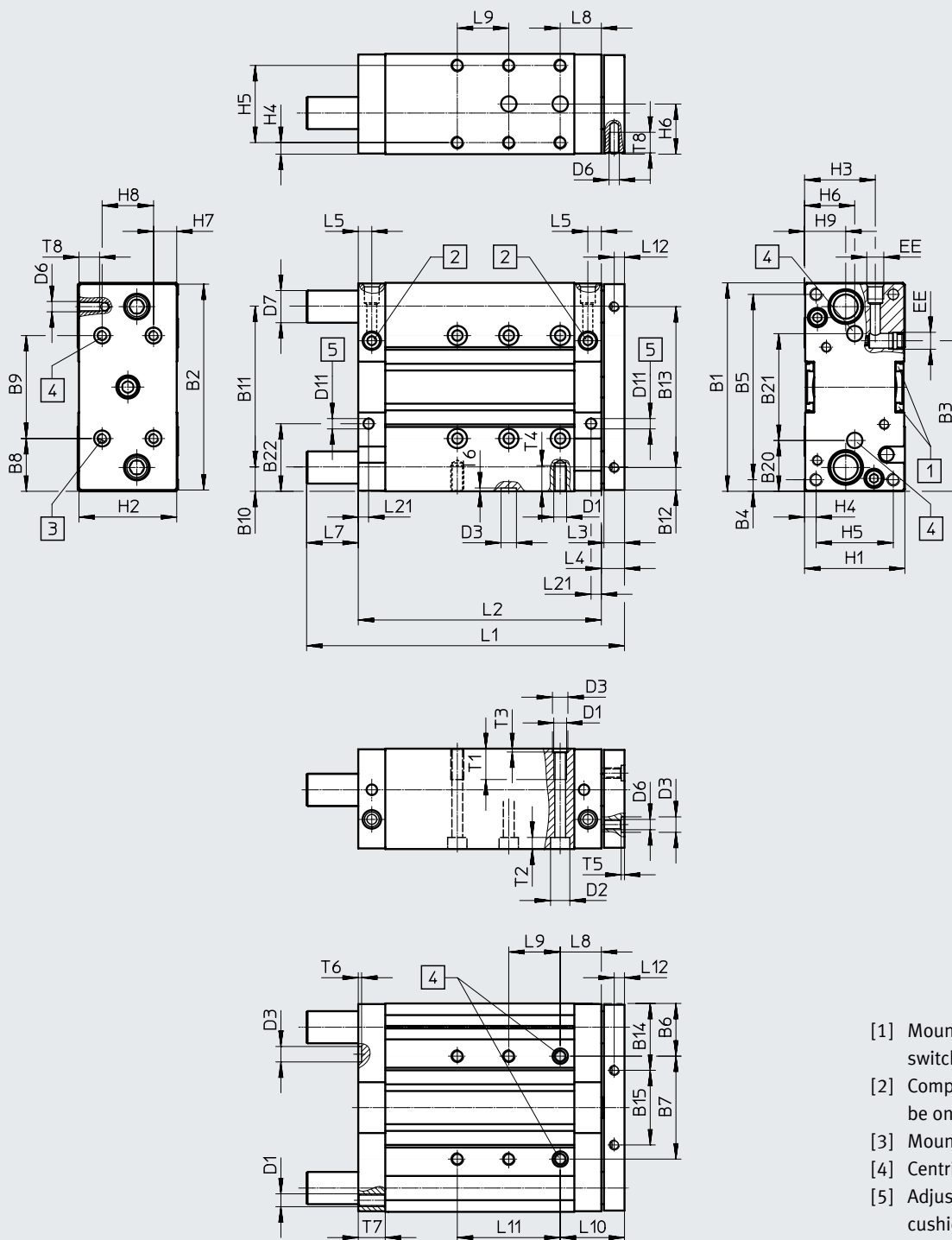

- [1] Mounting slot for proximity switch SME/SMT-8
- [2] Compressed air connection can be on the side or on top
- [3] Mounting thread
- [4] Centring holes
- [5] Adjustable pneumatic cushioning PPV

Datasheet

∅	B1	B2	B3	B4	B5	B6	B7	B8	B9	B10	B11	B12	B13	B14	B15	B20
[mm]							±0.02 ¹⁾		±0.02 ¹⁾							
50	148	146	104	19	110	42	64	44	60	19	110	18	110	52	42	40
63	162	160	116.5	9	144	41	80	41	80	18.5	125	17.5	125	51	58	39.5

∅	B21	B22	D1	D2	D3	D6	D7		D11	EE	H1	H2	H3	H4	H5	H6	H7
[mm]	±0.02 ¹⁾			∅	∅	∅	∅	∅	∅								
				H8			GF	KF									
50	68	52	M8	11	12	M8	25	20	8.8	G1/4	64	62	48.5	7	50	32	12
63	83	53.5	M10	15	12	M8	25	20	8.8	G1/4	78	76	54.5	9	60	39	19

∅	H8	H9	L3	L4	L5	L8	L10	L12	L21	T1	T2	T3	T4	T5	T6	T7	T8
[mm]																	
50	40	29	16	18	11.5	32	50	8	11.5	20	6.8	2.6	16	2.6	2.6	21	16
63	40	32	16	18	10.5	32	50	8	10.5	24	9	2.6	20	2.6	2.6	21	16

Stroke [mm]	Piston ∅ [mm]										
	50					63					
	L1	L2	L7	L9 ±0.02 ¹⁾	L11	L1	L2	L7	L9 ±0.02 ¹⁾	L11	
25	137	113	6	20	-	137	114	5	20	-	
50	177	138	21	40		80	177	139	20		40
80	227	168	41		227		169	61	40	320	
100	247	188	62		247		189				
125	293	213		139	293	214	138	138	320		
160	328	248	120		328	249					
200	368	288	160		368	289					
250	495	338	139	200	495	339	138	320			
320	565	408		240	565	409					
400	645	488		320	645	489					

1) Tolerance between the centring holes
 † Note: This product conforms to ISO 1179-1 and ISO 228-1.

Note

As the guide rods project beyond the housing when the unit is in its retracted end position (→ dimension L7), a recess must be provided in the mounting surface if the unit is to be mounted on the end face so that the guide rods can move freely.

When using a variable stroke, dimensions L1, L2, L7, L9 and L11 correspond to the next longest standard stroke.

Datasheet

Dimensions

Download CAD data → www.festo.com

YSRW – self-adjusting cushioning
 ∅ 50 ... 63 mm

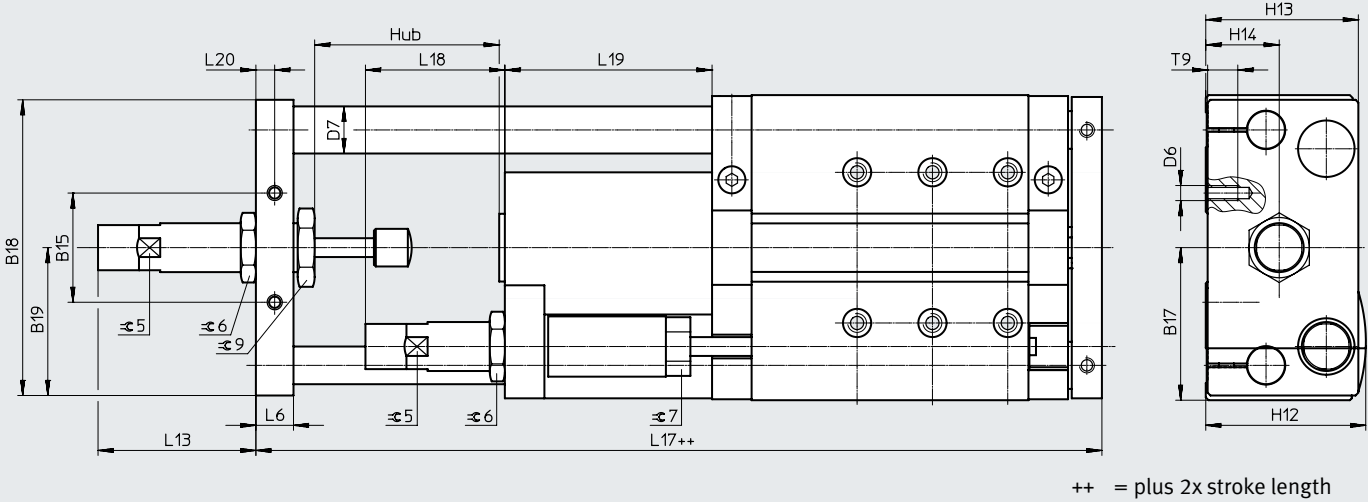

AJ/EJ – Precision stroke adjustment in the advanced and retracted end position
 ∅ 50 ... 63 mm

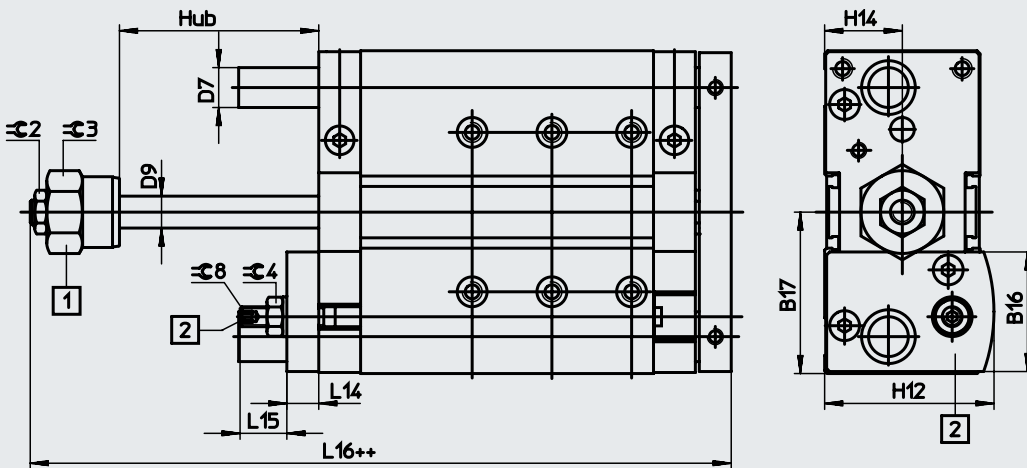

- [1] Variant AJ
- [2] Variant EJ
- ++ = plus 2x stroke length

Datasheet

∅ [mm]	B15	B16	B17	B18	B19	D6	D7 ∅		D9 ∅	H12	H13	H14	L6	L13	L14
							GF	KF							
50	42	57.6	74	144	72	M8	25	20	16	74	71	32	16	67.6	16
63	58	60	81	157	78.5	M8	25	20	16	81	81	39	20	83.3	16

∅ [mm]	L15	L16	L17	L18	L19	L20	T9	=C2	=C3	=C4	=C5	=C6	=C7	=C8	=C9
63	23.5	151.8	249.2	74	110	10	16	19	36	17	24	32	27	5	36

Ordering data – Modular product system

Ordering table												
Size	12	16	20	25	32	40	50	63	Condi- tions	Code	Enter code	
Module no.	529119	529120	532316	532317	532318	532319	534769	534770				
Function	Guided drive									DFM	DFM	
Piston Ø [mm]	12	16	20	25	32	40	50	63		-...		
Stroke [mm]	10	10	-	-	-	-	-	-		-...		
	20	20	20	20	20	-	-	-		-...		
	25	25	25	25	25	25	25	25		-...		
	30	30	30	30	30	-	-	-		-...		
	40	40	40	40	40	-	-	-		-...		
	50	50	50	50	50	50	50	50		-...		
	80	80	80	80	80	80	80	80		-...		
	100	100	100	100	100	100	100	100		-...		
	125	125	125	125	125	125	125	125		-...		
	160	160	160	160	160	160	160	160		-...		
	200	200	200	200	200	200	200	200		-...		
	-	-	250	250	250	250	250	250		-...		
-	-	320	320	320	320	320	320		-...			
-	-	400	400	400	400	400	400		-...			
Variable stroke [mm]	10 ... 200		20 ... 400			25 ... 400			[1]	-...		
Generation	B-series									-B	-B	
Cushioning	Elastic cushioning rings/plates at both ends									-P		
	-	Pneumatic cushioning adjustable at both ends									[2]	-PPV
Position sensing	Via proximity switch									-A	-A	
Guide	Plain-bearing guide									-GF	-GF	

[1] ... Not with precision adjustment AJ
 [2] **PPV** Not with precision adjustment AJ, EJ.

Ordering data – Modular product system

Ordering table		12	16	20	25	32	40	50	63	Condi- tions	Code	Enter code	
Temperature resistance	Heat-resistant seals up to max. 120 °C									[3]	S6		
Precision adjustment advanced	Precision adjustment in the end positions, advanced										-AJ		
Precision adjustment retracted	–	–	Precision adjustment in the end positions, retracted								-EJ		
Accessories	supplied loose										ZUB-	ZUB-	
Slot cover, sensor slot	1 ... 10										...S		
Proximity switch	with cable 2.5 m	1 ... 10										...G	
	contactless with ca- ble, 2.5 m	1 ... 10										...I	

[3] **S6** Not with precision adjustment AJ, EJ

Ordering data – Modular product system

Ordering table												
Size	12	16	20	25	32	40	50	63	Condi- tions	Code	Enter code	
Module no.	529119	529120	532316	532317	532318	532319	534769	534770				
Function	Guided drive									DFM	DFM	
Piston ø [mm]	12	16	20	25	32	40	50	63		-...		
Stroke [mm]	10	10	-	-	-	-	-	-		-...		
	20	20	20	20	20	-	-	-		-...		
	25	25	25	25	25	25	25	25		-...		
	30	30	30	30	30	-	-	-		-...		
	40	40	40	40	40	-	-	-		-...		
	50	50	50	50	50	50	50	50		-...		
	80	80	80	80	80	80	80	80		-...		
	100	100	100	100	100	100	100	100		-...		
	125	125	125	125	125	125	125	125		-...		
	160	160	160	160	160	160	160	160		-...		
	200	200	200	200	200	200	200	200		-...		
	-	-	250	250	250	250	250	250		-...		
	-	-	320	320	320	320	320	320		-...		
	-	-	400	400	400	400	400	400		-...		
Variable stroke [mm]	10 ... 200		20 ... 400			25 ... 400			[1]	-...		
Generation	B-series									-B	-B	
Cushioning	Elastic cushioning rings/plates at both ends									-P		
	-	Pneumatic cushioning adjustable at both ends								[2]	-PPV	
	-	-	Shock absorber, self-adjusting, progressive							[3]	-YSRW	
Position sensing	Via proximity switch									-A	-A	
Guide	Recirculating ball bearing guide									-KF	-KF	

[1] ... Not with precision adjustment A)

[2] **PPV** Not with precision adjustment A), E).

[3] **YSRW** Not with precision adjustment A), E), as already integrated.

Ordering data – Modular product system

Ordering table												
Size	12	16	20	25	32	40	50	63	Condi- tions	Code	Enter code	
Precision adjustment advanced	Precision adjustment in the end positions, advanced										-AJ	
Precision adjustment retracted	-	-	Precision adjustment in the end positions, retracted								-EJ	
Accessories	supplied loose										ZUB-	ZUB-
Slot cover, sensor slot	1 ... 10										...S	
Proximity switch	with cable 2.5 m										...G	
	contactless with cable, 2.5 m										...I	

Ordering data

Ordering data – Plain-bearing guide GF			Part no.		Type	Part no.		Type
Stroke [mm]	∅ 16 mm		∅ 20 mm			∅ 25 mm		
10	8165512	DFM-16-10-B-PPV-A-GF	-			-		
20	8162429	DFM-16-20-B-PPV-A-GF	8161411	DFM-20-20-B-PPV-A-GF	8161420	DFM-25-20-B-PPV-A-GF		
25	8162430	DFM-16-25-B-PPV-A-GF	8161412	DFM-20-25-B-PPV-A-GF	8161421	DFM-25-25-B-PPV-A-GF		
30	8162431	DFM-16-30-B-PPV-A-GF	8161413	DFM-20-30-B-PPV-A-GF	8161423	DFM-25-30-B-PPV-A-GF		
40	8162432	DFM-16-40-B-PPV-A-GF	8161414	DFM-20-40-B-PPV-A-GF	8161424	DFM-25-40-B-PPV-A-GF		
50	8162433	DFM-16-50-B-PPV-A-GF	8161415	DFM-20-50-B-PPV-A-GF	8161425	DFM-25-50-B-PPV-A-GF		
80	8162434	DFM-16-80-B-PPV-A-GF	8161416	DFM-20-80-B-PPV-A-GF	8161426	DFM-25-80-B-PPV-A-GF		
100	604968	DFM-16-100-B-PPV-A-GF	8161417	DFM-20-100-B-PPV-A-GF	578876	DFM-25-100-B-PPV-A-GF		
125	8162435	DFM-16-125-B-PPV-A-GF	8161418	DFM-20-125-B-PPV-A-GF	8161428	DFM-25-125-B-PPV-A-GF		
160	-		609167	DFM-20-160-B-PPV-A-GF	588785	DFM-25-160-B-PPV-A-GF		
200			8161419	DFM-20-200-B-PPV-A-GF	8165513	DFM-25-200-B-PPV-A-GF		
Stroke [mm]	∅ 32 mm		∅ 40 mm		∅ 50 mm			
20	8161431	DFM-32-20-B-PPV-A-GF	-		-			
25	562063	DFM-32-25-B-PPV-A-GF	8161440	DFM-40-25-B-PPV-A-GF	8165515	DFM-50-25-B-PPV-A-GF		
30	8161434	DFM-32-30-B-PPV-A-GF	-		-			
40	8161436	DFM-32-40-B-PPV-A-GF						
50	595430	DFM-32-50-B-PPV-A-GF	595646	DFM-40-50-B-PPV-A-GF	588730	DFM-50-50-B-PPV-A-GF		
80	578877	DFM-32-80-B-PPV-A-GF	8161443	DFM-40-80-B-PPV-A-GF	609206	DFM-50-80-B-PPV-A-GF		
100	578878	DFM-32-100-B-PPV-A-GF	8161445	DFM-40-100-B-PPV-A-GF	593601	DFM-50-100-B-PPV-A-GF		
125	578879	DFM-32-125-B-PPV-A-GF	8161446	DFM-40-125-B-PPV-A-GF	-			
160	578880	DFM-32-160-B-PPV-A-GF	-					
200	604969	DFM-32-200-B-PPV-A-GF						
250	578881	DFM-32-250-B-PPV-A-GF						

Ordering data – Recirculating ball bearing guide KF			Part no.		Type	Part no.		Type
Stroke [mm]	∅ 16 mm		∅ 20 mm			∅ 25 mm		
10	609346	DFM-16-10-B-PPV-A-KF	-		-			
20	609345	DFM-16-20-B-PPV-A-KF	609349	DFM-20-20-B-PPV-A-KF	609351	DFM-25-20-B-PPV-A-KF		
25	559460	DFM-16-25-B-PPV-A-KF	559477	DFM-20-25-B-PPV-A-KF	8161422	DFM-25-25-B-PPV-A-KF		
30	609347	DFM-16-30-B-PPV-A-KF	609348	DFM-20-30-B-PPV-A-KF	578921	DFM-25-30-B-PPV-A-KF		
40	559461	DFM-16-40-B-PPV-A-KF	559478	DFM-20-40-B-PPV-A-KF	609350	DFM-25-40-B-PPV-A-KF		
50	559462	DFM-16-50-B-PPV-A-KF	559479	DFM-20-50-B-PPV-A-KF	604962	DFM-25-50-B-PPV-A-KF		
80	559463	DFM-16-80-B-PPV-A-KF	559480	DFM-20-80-B-PPV-A-KF	609352	DFM-25-80-B-PPV-A-KF		
100	559464	DFM-16-100-B-PPV-A-KF	559481	DFM-20-100-B-PPV-A-KF	8161427	DFM-25-100-B-PPV-A-KF		
125	559465	DFM-16-125-B-PPV-A-KF	559482	DFM-20-125-B-PPV-A-KF	8161429	DFM-25-125-B-PPV-A-KF		
160	-		559483	DFM-20-160-B-PPV-A-KF	609353	DFM-25-160-B-PPV-A-KF		
200			559484	DFM-20-200-B-PPV-A-KF	8161430	DFM-25-200-B-PPV-A-KF		
Stroke [mm]	∅ 32 mm		∅ 40 mm		∅ 50 mm			
20	8161432	DFM-32-20-B-PPV-A-KF	-		-			
25	8161433	DFM-32-25-B-PPV-A-KF	8161441	DFM-40-25-B-PPV-A-KF	8161448	DFM-50-25-B-PPV-A-KF		
30	8161435	DFM-32-30-B-PPV-A-KF	-		-			
40	8161437	DFM-32-40-B-PPV-A-KF						
50	609359	DFM-32-50-B-PPV-A-KF	8161442	DFM-40-50-B-PPV-A-KF	609361	DFM-50-50-B-PPV-A-KF		
80	609355	DFM-32-80-B-PPV-A-KF	8161444	DFM-40-80-B-PPV-A-KF	8161449	DFM-50-80-B-PPV-A-KF		
100	609357	DFM-32-100-B-PPV-A-KF	8165514	DFM-40-100-B-PPV-A-KF	8161450	DFM-50-100-B-PPV-A-KF		
125	609358	DFM-32-125-B-PPV-A-KF	8161447	DFM-40-125-B-PPV-A-KF	-			
160	609356	DFM-32-160-B-PPV-A-KF	-					
200	8161438	DFM-32-200-B-PPV-A-KF						
250	8161439	DFM-32-250-B-PPV-A-KF						

Accessories

Ordering data					
	Description	Weight [g]	Part no.	Type	PE ¹⁾
Centring sleeve ZBH Datasheets → Internet: zbh					
	To be attached to the housing and the yoke plate	1	8146543	ZBH-5-B	10
		1	8146544	ZBH-7-B	
		1	8137184	ZBH-9-B	
		1	8137185	ZBH-12-B	
		1	191409	ZBH-15	

1) Packaging unit

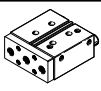
Centring sleeves included in the scope of delivery			
DFM	Piston ø [mm]	Centring sleeves	
		For housing	For yoke plate
	12	2x ZBH-5, 2x ZBH-9	2x ZBH-5
	16	2x ZBH-5, 2x ZBH-9	2x ZBH-5
	20	2x ZBH-7, 2x ZBH-9	2x ZBH-9
	25	2x ZBH-7, 2x ZBH-9	2x ZBH-9
	32	2x ZBH-9, 2x ZBH-12	2x ZBH-9
	40	2x ZBH-9, 2x ZBH-12	2x ZBH-9
	50	2x ZBH-12	2x ZBH-12
	63	2x ZBH-12	2x ZBH-12
	80	2x ZBH-12	2x ZBH-12
	100	2x ZBH-15	2x ZBH-15

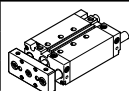
Centring sleeves included in the scope of delivery			
DFM-B	Piston ø [mm]	Centring sleeves	
		For housing	For yoke plate
	12	2x ZBH-5, 2x ZBH-9	2x ZBH-5
	16	2x ZBH-5, 2x ZBH-9	2x ZBH-5
	20	2x ZBH-7, 2x ZBH-9	2x ZBH-9
	25	2x ZBH-7, 2x ZBH-9	2x ZBH-9
	32	2x ZBH-9, 2x ZBH-12	2x ZBH-9
	40	2x ZBH-9, 2x ZBH-12	2x ZBH-9
	50	2x ZBH-12	2x ZBH-12
	63	2x ZBH-12	2x ZBH-12
	–	–	–
	–	–	–

Proximity switch for piston ø 6, 10 with DFM

Ordering data – Proximity switch for C-slot, magneto-resistive

Datasheets → Internet: smt

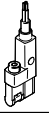
	Type of mounting	Switching output	Electrical connection, outlet direction of connection	Cable length [m]	Part no.	Type
N/O						
	Inserted into the slot lengthwise	PNP	Cable, 3-core, crosswise	2.5	547862	SMT-10G-PS-24V-E-2.5Q-OE
			Plug M8x1, 3-pin, crosswise	0.3	547863	SMT-10G-PS-24V-E-0.3Q-M8D
		NPN	Cable, 3-core, crosswise	2.5	8065030	SMT-10G-NS-24V-E-2.5Q-OE
			Plug M8x1, 3-pin, crosswise	0.3	8065029	SMT-10G-NS-24V-E-0.3Q-M8D

Accessories

Proximity sensor for piston \varnothing 12 with DFM-B

Ordering data – Proximity switch for C-slot, magneto-resistive

Datasheets → Internet: smt

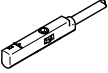
	Type of mounting	Switching output	Electrical connection, outlet direction of connection	Cable length [m]	Part no.	Type
N/O						
	Inserted in the slot from above	PNP	Cable, 3-core, lengthwise	2.5	★ 551373	SMT-10M-PS-24V-E-2.5-L-OE
			Plug M8x1, 3-pin, in-line	0.3	★ 551375	SMT-10M-PS-24V-E-0.3-L-M8D
			Plug M8x1, 3-pin, crosswise	0.3	551376	SMT-10M-PS-24V-E-0.3-Q-M8D

Ordering data – Proximity switch for C-slot, magnetic reed

Datasheets → Internet: sme

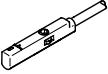
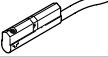
	Type of mounting	Switching output	Electrical connection, outlet direction of connection	Cable length [m]	Part no.	Type
N/O						
	Inserted in the slot from above	Contacting	Plug M8x1, 3-pin, in-line	0.3	★ 551367	SME-10M-DS-24V-E-0.3-L-M8D
			Cable, 3-core, lengthwise	2.5	★ 551365	SME-10M-DS-24V-E-2.5-L-OE
			Cable, 2-core, lengthwise	2.5	★ 551369	SME-10M-ZS-24V-E-2.5-L-OE
	Inserted into the slot lengthwise	Contacting	Plug M8x1, 3-pin, in-line	0.3	173212	SME-10-SL-LED-24
			Cable, 3-core, lengthwise	2.5	173210	SME-10-KL-LED-24

Proximity switch for piston \varnothing 12 ... 100

Ordering data – Proximity switch for T-slot, magneto-resistive

Datasheets → Internet: smt

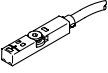
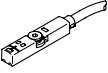
	Type of mounting	Switching output	Electrical connection	Cable length [m]	Part no.	Type
N/O						
	Inserted in the slot from above, flush with the cylinder profile, short design	PNP	Cable, 3-core	2.5	★ 574335	SMT-8M-A-PS-24V-E-2.5-OE
			Plug M8x1, 3-pin	0.3	★ 574334	SMT-8M-A-PS-24V-E-0.3-M8D
			Plug M12x1, 3-pin	0.3	★ 574337	SMT-8M-A-PS-24V-E-0.3-M12
		NPN	Cable, 3-core	2.5	★ 574338	SMT-8M-A-NS-24V-E-2.5-OE
			Plug M8x1, 3-pin	0.3	★ 574339	SMT-8M-A-NS-24V-E-0.3-M8D
N/C						
	Inserted in the slot from above, flush with the cylinder profile, short design	PNP	Cable, 3-core	7.5	★ 574340	SMT-8M-A-PO-24V-E-7.5-OE

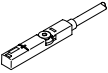
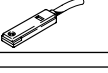
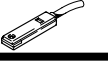

Ordering data – Proximity switch for T-slot, magnetic reed

Datasheets → Internet: sme

	Type of mounting	Switching output	Electrical connection	Cable length [m]	Part no.	Type
N/O						
	Inserted in the slot from above, flush with the cylinder profile	Contacting	Cable, 3-core	2.5	★ 543862	SME-8M-DS-24V-K-2.5-OE ¹⁾
				5.0	★ 543863	SME-8M-DS-24V-K-5.0-OE ¹⁾
			Cable, 2-core	2.5	★ 543872	SME-8M-ZS-24V-K-2.5-OE ¹⁾
			Plug M8x1, 3-pin	0.3	★ 543861	SME-8M-DS-24V-K-0.3-M8D ¹⁾
	Inserted in the slot lengthwise, flush with the cylinder profile	Contacting	Cable, 3-core	2.5	150855	SME-8-K-LED-24 ¹⁾
			Plug M8x1, 3-pin	0.3	150857	SME-8-S-LED-24 ¹⁾
N/C						
	Inserted in the slot lengthwise, flush with the cylinder profile	Contacting	Cable, 3-core	7.5	160251	SME-8-O-K-LED-24 ¹⁾

1) Not compatible with cylinders DFM-...-GF-F1A

Accessories

Ordering data – Connecting cables				Datasheets → Internet: nebu		
	Electrical connection, left		Electrical connection, right	Cable length [m]	Part no.	Type
		Straight socket, M8x1, 3-pin	Cable, open end, 3-core	2.5	★ 541333	NEBU-M8G3-K-2.5-LE3
5				★ 541334	NEBU-M8G3-K-5-LE3	
Straight socket, M12x1, 5-pin		Cable, open end, 3-core	2.5	★ 541363	NEBU-M12G5-K-2.5-LE3	
			5	★ 541364	NEBU-M12G5-K-5-LE3	
	Angled socket, M8x1, 3-pin	Cable, open end, 3-core	2.5	★ 541338	NEBU-M8W3-K-2.5-LE3	
			5	★ 541341	NEBU-M8W3-K-5-LE3	
	Angled socket, M12x1, 5-pin	Cable, open end, 3-core	2.5	541367	NEBU-M12W5-K-2.5-LE3	
			5	541370	NEBU-M12W5-K-5-LE3	

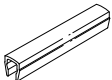
Ordering data – Slot cover for T-slot				
	Mounting	Length	Part no.	Type
	Insertable	2x 0.5 m	151680	ABP-5-S

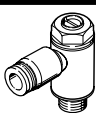
Ordering data – One-way flow control valves				Datasheets → Internet: grla	
	Connection		Material	Part no.	Type
	Thread	For tubing O.D.			
	M3	–	Metal design	175038	GRLA-M3
		3		175041	GRLA-M3-QS-3
	M5	3		★ 193137	GRLA-M5-QS-3-D
		4		★ 193138	GRLA-M5-QS-4-D
		6		★ 193139	GRLA-M5-QS-6-D
	G1/8	3		★ 193142	GRLA-1/8-QS-3-D
		4		★ 193143	GRLA-1/8-QS-4-D
		6		★ 193144	GRLA-1/8-QS-6-D
		8		★ 193145	GRLA-1/8-QS-8-D
	G1/4	6		★ 193146	GRLA-1/4-QS-6-D
		8		★ 193147	GRLA-1/4-QS-8-D
		10		★ 193148	GRLA-1/4-QS-10-D
	G3/8	6		★ 193149	GRLA-3/8-QS-6-D
		8		★ 193150	GRLA-3/8-QS-8-D
		10		★ 193151	GRLA-3/8-QS-10-D

Accessories

Adapter kit
DHAA, HAPB

Material:
Wrought aluminium alloy
RoHS-compliant



Note

The kit includes the individual mounting interface as well as the necessary mounting material.

Permissible drive/drive combinations with adapter kit

Download CAD data → www.festo.com

Combination	[1] Drive	[2] Drive	Adapter kit		
	Size	Size	CRC ¹⁾	Part no.	Type
DGC/DFM	DGC	DFM	DHAA		
	25	12, 16, 20	2	562152	DHAA-D-L-25-G7-12
	32	20, 25		562153	DHAA-D-L-32-G7-20
	40	25, 32, 40		562154	DHAA-D-L-40-G7-25
EGC/DFM	EGC	DFM	DHAA		
	80	12, 16, 20	2	562152	DHAA-D-L-25-G7-12
	120	25, 32, 40		562154	DHAA-D-L-40-G7-25

1) More information www.festo.com/x/topic/crc