

Classic Tiger Series Power Valves

5/2 - 5 Ported, 4 Way, 2 Position Valves, G 1/8 and 1/8" NPT

FESTO

Single Pilot Valve

Spring Return
Type VL-5-1/8
VL-5-1/8-NPT

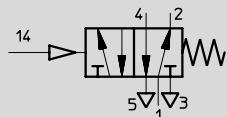

The valve is actuated only while pilot pressure is applied at port 14.

In this state, the valve allows flow from 1 to 4. Return is by means of a spring as soon as the pneumatic signal is removed.

Manifolds: Type PAL-..., see page 451.
Type PRS-..., see page 452.

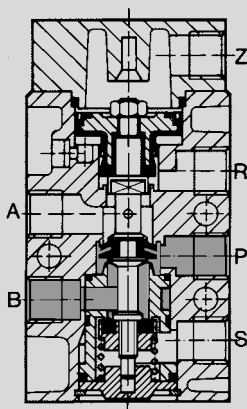

Cover with port Z can be rotated 180°

- 1 (P) = Supply
- 4, 2 (A, B) = Outlet
- 5, 3 (R, S) = Exhaust
- 14 (Z) = Pilot

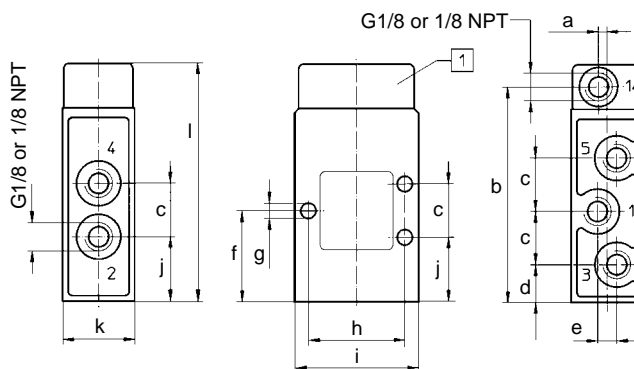
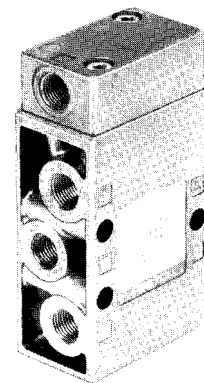

1 Cover with pilot port 14 (Z) can be rotated 180°

Dimensions

a	0.12 in / 3 mm	g	0.21 in / 5.5 mm
b	3.03 in / 77 mm	h	1.37 in / 35 mm
c	0.74 in / 19 mm	i	1.77 in / 45 mm
d	0.53 in / 13.5 mm	j	0.90 in / 23 mm
e	0.27 in / 7 mm	k	1.02 in / 26 mm
f	1.27 in / 32.5 mm	l	3.34 in / 85 mm

Minimum pilot pressure versus supply pressure

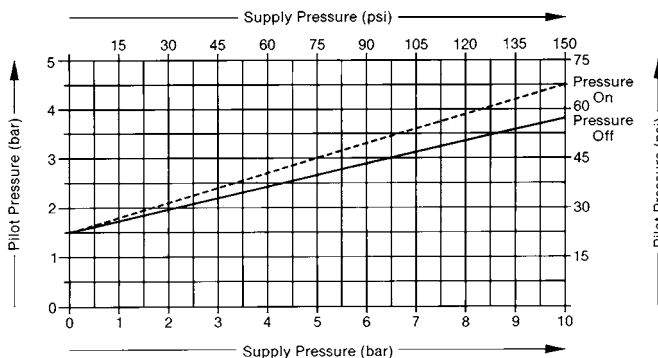

Order Number	Part No./Type	9764 VL-5-1/8	10843 VL-5-1/8-NPT
Medium		Compressed air (filtered, lubricated or unlubricated)	
Design		Poppet valve, with spring return	
Mounting		3 through-holes in housing	
Connection	Working Ports	G 1/8	1/8 NPT
	Pilot Port	G 1/8	1/8 NPT
Orifice Size		0.19 in / 5 mm	
C _v Factor (P → A)		0.5 C _v / 500 l/min	
Supply Pressure Range*		0 to 150 psi / 0 to 10 bar	
Pilot Pressure Range		See graph (max. 150 psi / 10 bar)	
Response Time at 90 psi / 6 bar		On: 5 ms, Off: 16 ms	
Materials		Housing: die cast aluminum, anodized. Seals: Buna N	
Weight		0.397 lb / 0.180 kg	

*14 to 140°F / -10 to +60°C

Classic Tiger Series Power Valves

5/2 - 5 Ported, 4 Way, 2 Position Valves, G 1/4 and 1/4" NPT

Single Pilot Valve

Spring Return

Type VL-5-1/4

VL-5-1/4-NPT

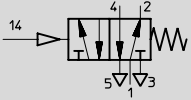

The valve is actuated only while pilot pressure is applied at port 14.

In this state, the valve allows flow from 1 to 4. Return is by means of a spring as soon as the pneumatic signal is removed.

Manifolds: Type PAL-..., see page 451.
Type PRS-..., see page 452.

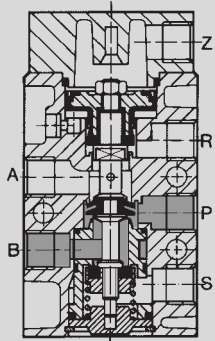

Cover with port Z can be rotated 180°

- 1 (P) = Supply
- 4, 2 (A, B) = Outlet
- 5, 3 (R, S) = Exhaust
- 14 (Z) = Pilot

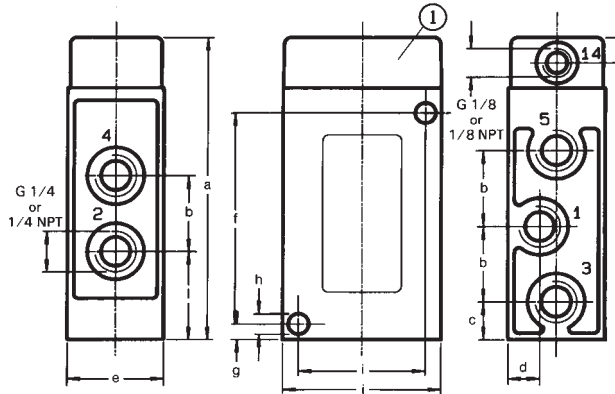

Dimensions

- a 3.78 in / 96 mm
- b 0.95 in / 24 mm
- c 0.47 in / 12 mm
- d 0.39 in / 10 mm
- e 1.20 in / 30.4 mm
- f 2.64 in / 67 mm
- g 0.20 in / 5 mm
- h 0.26 in / 6.5 mm
- i 1.58 in / 40 mm
- j 1.97 in / 50 mm
- k 0.31 in / 8 mm
- l 1.10 in / 28 mm

Minimum Pilot Pressure Versus Supply Pressure

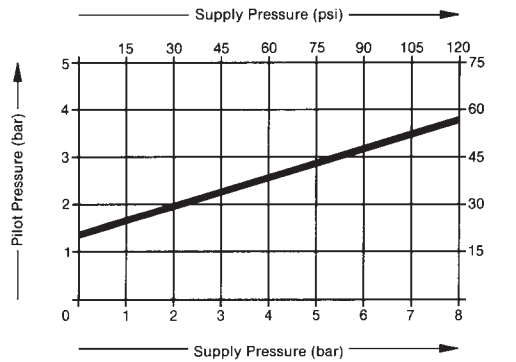

① Cover with port Z can be turned 180°

Order Number	Part No./Type	9199 VL-5-1/4	10844 VL-5-1/4-NPT
Medium		Compressed air (filtered, lubricated or unlubricated)	
Mounting		Two holes through housing	
Connection	Working Ports	G 1/4 ISO	1/4 NPT
	Pilot Port	G 1/8 ISO	1/8 NPT
Orifice Size		0.28 in / 7 mm	
C _v Factor (P → A)		1.0 C _v / 1000 l/min	
Supply Pressure Range*		15 to 120 psi / 1 to 8 bar	
Pilot Pressure Range		See graph (max. 150 psi / 10 bar)	
Response Time at 90 psi / 6 bar		On: 8 ms, Off: 12 ms.	
Design		Poppet valve, with spring return	
Materials		Housing: Diecast aluminum, anodized. Seals: Buna N	
Weight		0.485 lb / 0.220 kg	

*14 to 140°F / -10 to +60°C

Festo - Your Partner in Automation



1 Festo Inc.
5300 Explorer Drive
Mississauga, ON L4W 5G4
Canada

Festo Customer Interaction Center
Tel: 1 877 463 3786
Fax: 1 877 393 3786
Email: customer.service.ca@festo.com

2 Festo Pneumatic
Av. Ceylán 3,
Col. Tequesquináhuac
54020 Tlalneantla,
Estado de México

Multinational Contact Center
01 800 337 8669
ventas.mexico@festo.com

3 Festo Corporation
1377 Motor Parkway
Suite 310
Islandia, NY 11749

Festo Customer Interaction Center
1 800 993 3786
1 800 963 3786
customer.service.us@festo.com

4 Regional Service Center
7777 Columbia Road
Mason, OH 45040

Connect with us



www.festo.com/socialmedia



www.festo.com

Subject to change