

Pneumatic valves VUWS/valve manifold assembly VTUS, NPT

FESTO

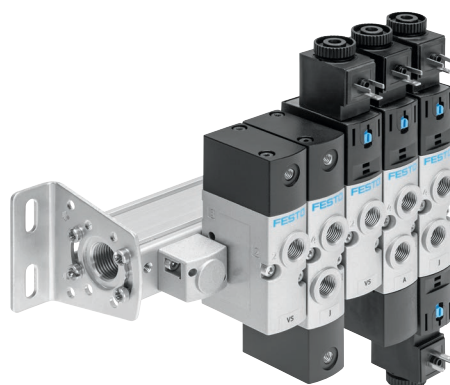

Key features – Pneumatic components

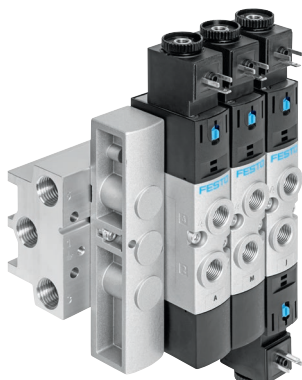

Innovative

- A reliable, robust valve with a long service life
- Design principle:
 - Poppet seat, soft-sealing (VUWS-LT)
 - Piston spool with sealing cartridge (VUWS-L)
- Flow rate up to 1800 l/min with VUWS-LT
- Flow rate up to 2300 l/min with VUWS-L
- Wide range of valve functions

Versatile

- In-line valves can be used as individual valves or manifold valves
- Variable pressure zones
- Wide range of mounting options

Reliable

- Ergonomic and safe operation
- Durable thanks to tried and tested piston spools
- Reliable servicing thanks to valves that can be replaced quickly and easily

Easy to mount

- Pre-assembled units on rails
- Individual valves assembled ready for installation
- Supply manifolds for mounting on both sides
- Secure wall mounting or H-rail mounting

Ordering data – Product options

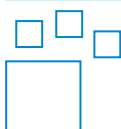

Configurable product
This product and all its product options can be ordered using the configurator.

The configurator can be found at
→ www.festo.com/catalogue/...
Enter the part number or the type.

Part no.	Type
576517	VUWS-20
8022015	VUWS-25
8022018	VUWS-30
577304	VTUS-20
8022016	VTUS-25
8022019	VTUS-30

Key features

Pneumatic valves VUWS

In-line valve VUWS-L as individual valve (piston spool valve)

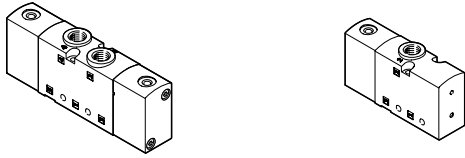

In-line valve VUWS-LT as individual valve (poppet seat valve)

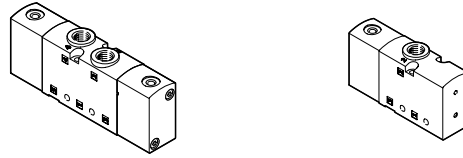

Valve manifold assembly VTUS

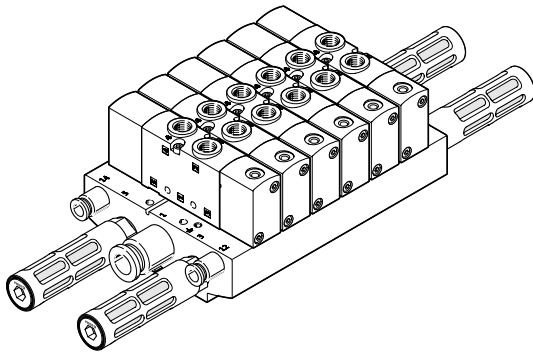

In-line valves are designed to be used without being linked pneumatically. All pneumatic connections are on the valve and can be equipped with fittings/tubing. By using a special seal set, the in-line valves can also be mounted on a manifold rail (pneumatic linking) as semi in-line valves.

Pneumatic valves VUWS have a sturdy design that enables them to be used in harsh environments. Pneumatic valves VUWS are extremely well suited for controlling cylinders or compressed air networks for easy clamping and locking processes in semi-automatic assembly and manufacturing.

Equipment options

VUWS-LT

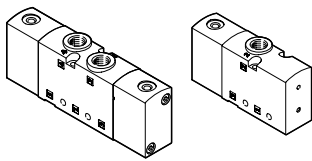

- 3/2-, 2x 3/2- and 5/2-way valves
- Size 20 (21 mm)
- Size 25 (26.5 mm)
- Size 30 (31 mm)
- In-line valves

Valve functions VUWS-LT

3/2-way valve, normally open, monostable:

- Reset via mechanical spring
- Flow direction not reversible

3/2-way valve, normally closed, monostable:

- Reset via mechanical spring
- Flow direction not reversible

2x 3/2-way valve, normally open, monostable:

- Reset via mechanical spring
- Flow direction not reversible

2x 3/2-way valve, normally closed, monostable:

- Reset via mechanical spring
- Flow direction not reversible

2x 3/2-way valve, 1x normally open, 1x normally closed, monostable:

- Reset via mechanical spring
- Flow direction not reversible

5/2-way monostable valve:

- Reset via mechanical spring
- Flow direction not reversible
- Can also be used as 3/2-way valve by closing one outlet port

5/2-way bistable valve:

- Flow direction not reversible

Key features

Equipment options

VUWS-L

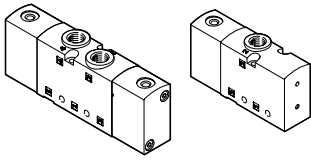

- Size 20 (21 mm)
- Size 25 (26.5 mm)
- Size 30 (31 mm)
- 3/2-, 5/2- and 5/3-way valves
- In-line valves

Valve functions VUWS-L

3/2-way valve, normally open, monostable:

- External pneumatic spring connection (M32U-E)
- Reset via pneumatic/mechanical spring
- Flow direction reversible with mechanical spring return or external pneumatic spring connection
- Dual-pressure operation possible
- If the external pneumatic spring connection is used as signal input, the result is a dominant bistable valve

3/2-way valve, normally closed, monostable:

- External pneumatic spring connection (M32C-E)
- Reset via pneumatic/mechanical spring
- Flow direction reversible with mechanical spring return or external pneumatic spring connection
- Dual-pressure operation possible
- If the external pneumatic spring connection is used as signal input, the result is a dominant bistable valve

5/2-way monostable valve:

- External pneumatic spring connection (M52-E)
- Reset via pneumatic/mechanical spring
- Flow direction reversible with mechanical spring return or external pneumatic spring connection
- Can also be used as 3/2-way valve by closing one outlet port

5/2-way bistable valve:

- Flow direction reversible

5/3-way valve, mid-position

exhausted, pressurised or closed:

- Flow direction reversible
- Reset via mechanical spring

Key features

- A maximum of 16 valve positions can be configured in the standard version
- A maximum of 12 valve positions can be configured in the compact version
- Valve positions 2 ... 10 in increments of 1, valve positions 10 ... 16 in increments of 2
- Manifold block with a maximum of 10 valve positions
- Extension module with 2 valve positions
- Common supply manifold with a maximum of 10 valve positions
- Creation of pressure zones (maximum 9 pressure zones in the case of a valve manifold assembly with 16 valve positions)

Design

Valve replacement

Each valve is attached to the manifold block using two screws. The appropriate seal is mounted on the valve.

This means that the valves can be easily replaced.

Extension

Valve positions covered with blanking plates can be replaced with valves at a later date.

The dimensions, mounting points and existing pneumatic installations remain unchanged.

For the standard manifold block, extension modules with 2 valve positions are available.

Key features

Standard manifold block

For 3/2-way valves

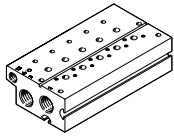

- Connection:
Size 20: 3/8 NPT
Size 25: 1/2 NPT
Size 30: 3/4 NPT
- Maximum 10 valve positions

For 5/2- and 5/3-way valves

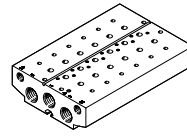

- Connection:
Size 20: 3/8 NPT
Size 25: 1/2 NPT
Size 30: 3/4 NPT
- Maximum 10 valve positions

Compact manifold block

For 3/2-way valves

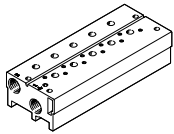

- Connection:
Size 20: 1/4 NPT
Size 25: 3/8 NPT
Size 30: 1/2 NPT
- Maximum 10 valve positions

For 5/2- and 5/3-way valves

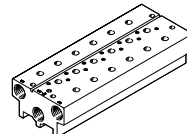

- Connection:
Size 20: 1/4 NPT
Size 25: 3/8 NPT
Size 30: 1/2 NPT
- Maximum 10 valve positions

Common supply manifold

Mounting on both sides

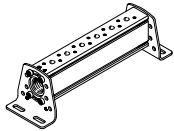

- Connection:
Size 20: 3/8 NPT
Size 25: 1/2 NPT
Size 30: 3/4 NPT
- Maximum 10 valve positions

Blanking plate for vacant position

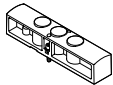

For covering unused valve positions

Supply plate

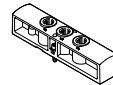

For additional air supply and exhaust via a valve position

Separator for pressure zones



For creating pressure zones (maximum of 9 pressure zones permitted)

Note

A filter must be installed upstream of valves operated in vacuum mode. This prevents any foreign matter in the intake air getting into the valve (e.g. when operating a suction cup).

Key features – Pneumatic components

Creating pressure zones and separating exhaust air

Compressed air is supplied and exhausted via the manifold block/common supply manifold and via supply plates.

The position of the supply plates and duct separations can be freely selected with the VTUS.

A pressure zone is created by isolating the internal ducts between the valve positions with an appropriate separator.

The separator can be used in the following ducts:

- Duct 1
- Duct 3
- Duct 5

 **Note**

- Use a separator if the exhaust air pressures are high
- Use at least one supply plate/air supply for each pressure zone

Duct separation

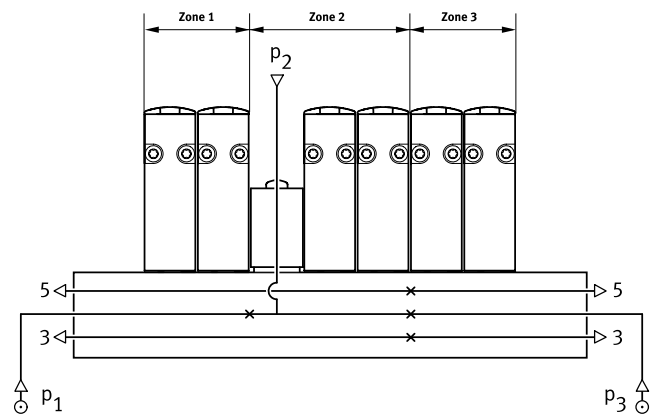
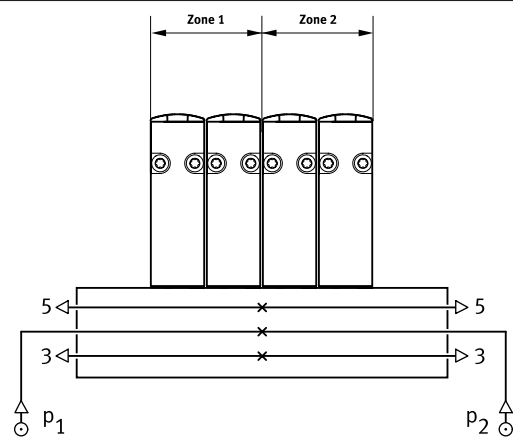

Description

The pressure zones can be freely configured with the VTUS. The following duct separations are possible:

- Duct 1 closed

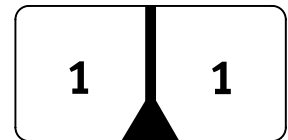

- Duct 1/3/5 closed

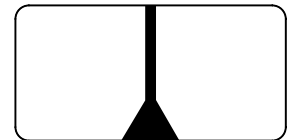

- Duct 3/5 closed

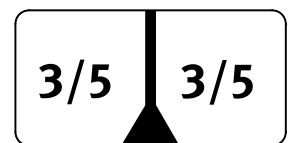

The number of pressure zones with the VTUS is limited by the number of valve positions on the manifold block/common supply manifold. Note that each supply plate occupies one valve position. There must always be at least 2 valve positions between 2 separators. In the case of a maximum extension of 16 valve positions, a maximum of 9 pressure zones can be created.

Key features – Pneumatic components VUWS-LT

Size 20 – Standard nominal flow rate q_{nN} , with several valves n switched in parallel

For 3/2-way valves

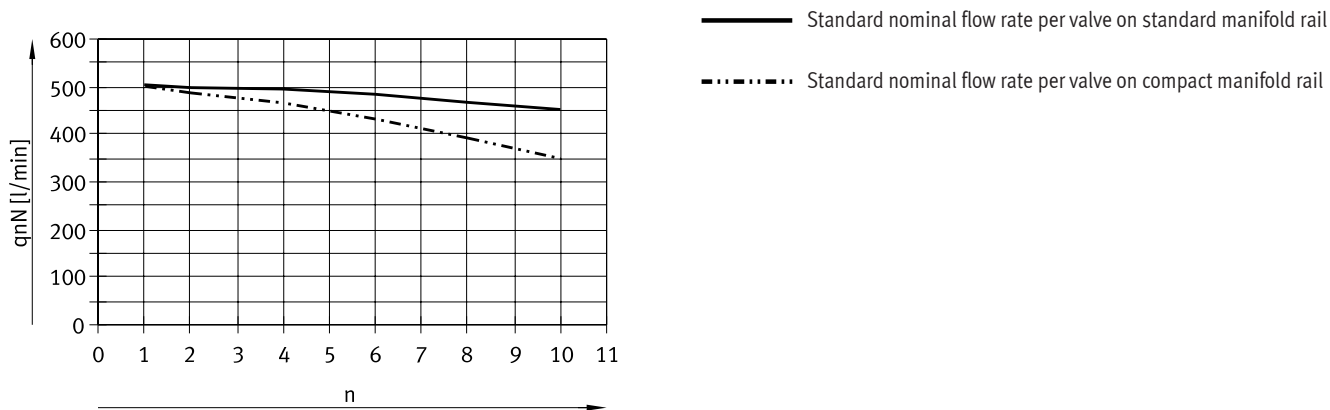

For 5/2-way valves, flow direction 1 → 2

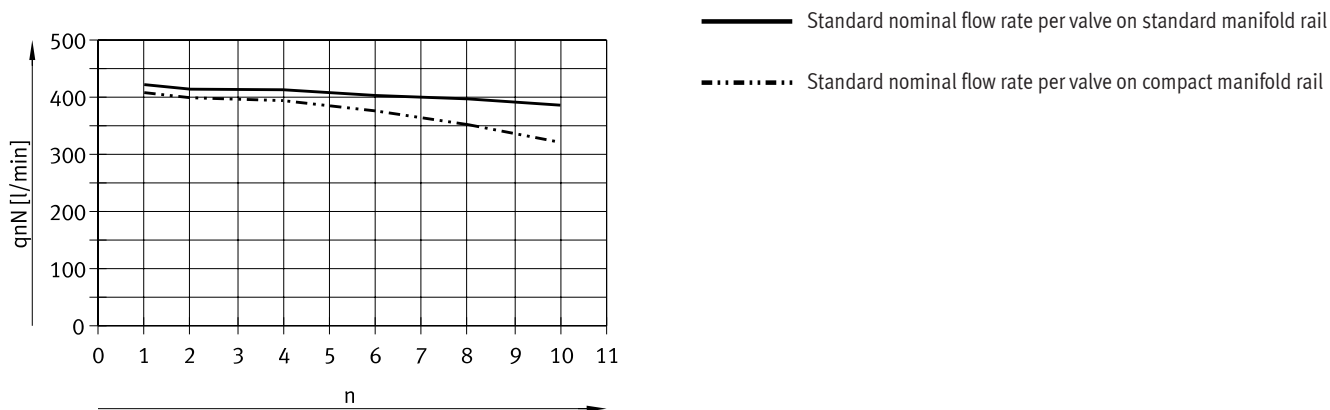

For 5/2-way valves, flow direction 1 → 4

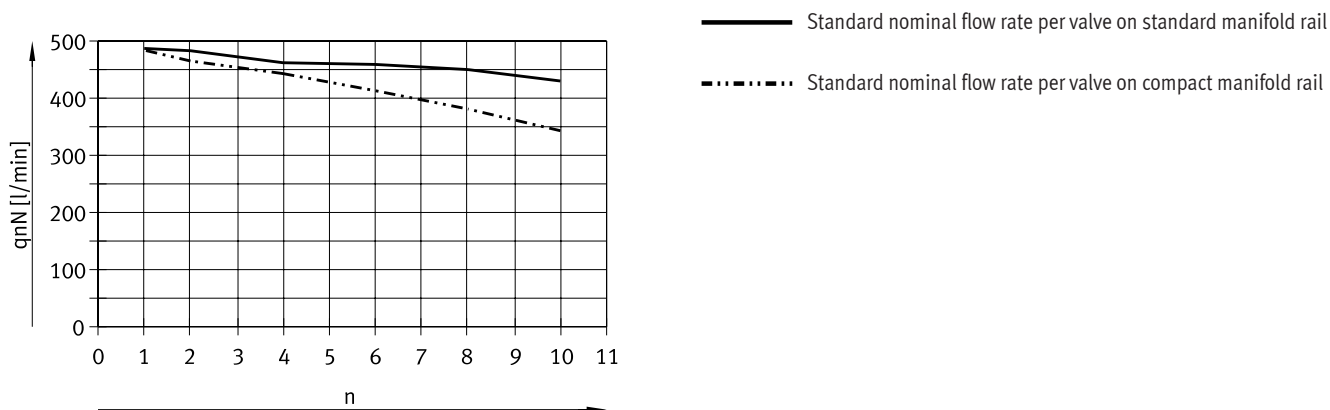

Key features – Pneumatic components VUWS-LT

Size 20 – Standard nominal flow rate q_{nN} , with several valves n switched in parallel

For 2x 3/2-way valves

One valve function per valve position in open switching position

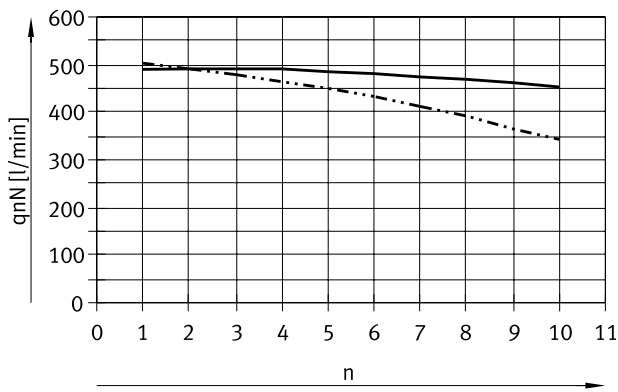

— Standard nominal flow rate per valve on standard manifold rail

- - - Standard nominal flow rate per valve on compact manifold rail

For 2x 3/2-way valves

Both valve functions per valve position simultaneously in open switching position

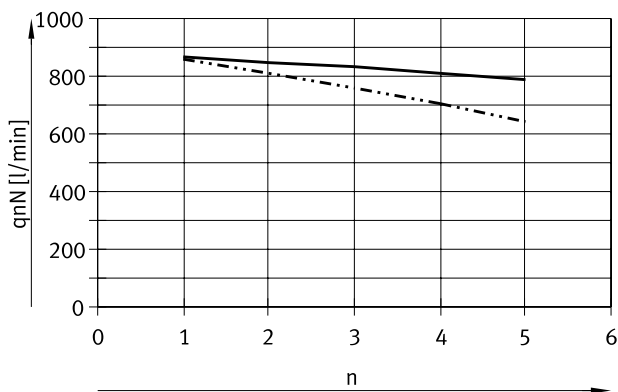

— Standard nominal flow rate per valve on standard manifold rail

- - - Standard nominal flow rate per valve on compact manifold rail

Key features – Pneumatic components VUWS-LT

Size 25 – Standard nominal flow rate q_{nN} , with several valves n switched in parallel

For 3/2-way valves

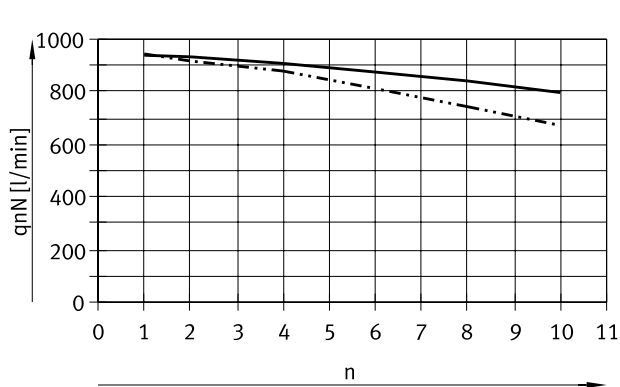

- Standard nominal flow rate per valve on standard manifold rail
- - - Standard nominal flow rate per valve on compact manifold rail

For 5/2-way valves, flow direction 1 → 2

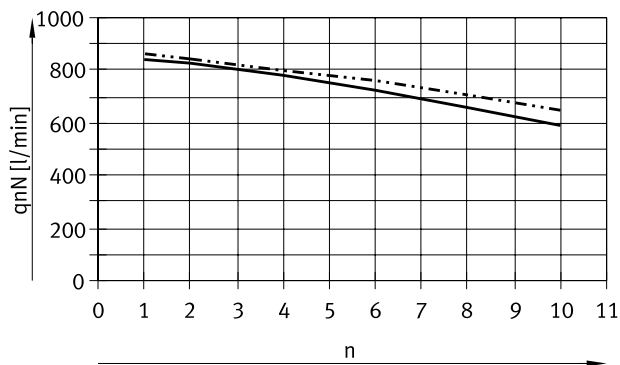

- Standard nominal flow rate per valve on standard manifold rail
- - - Standard nominal flow rate per valve on compact manifold rail

For 5/2-way valves, flow direction 1 → 4

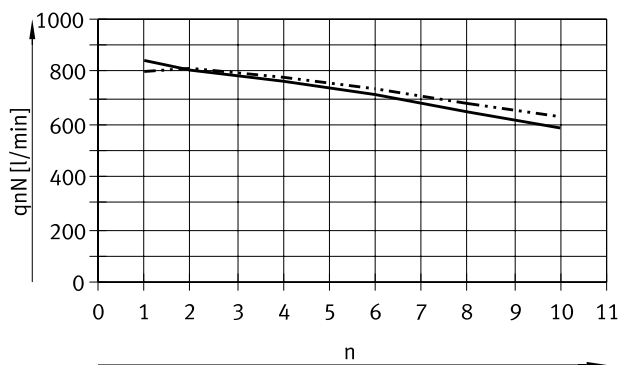

- Standard nominal flow rate per valve on standard manifold rail
- - - Standard nominal flow rate per valve on compact manifold rail

Key features – Pneumatic components VUWS-LT

Size 25 – Standard nominal flow rate q_{nN} , with several valves n switched in parallel

For 2x 3/2-way valves

One valve function per valve position in open switching position

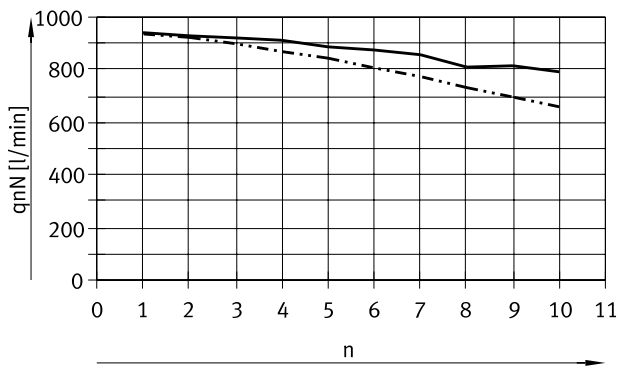

— Standard nominal flow rate per valve on standard manifold rail

- - - Standard nominal flow rate per valve on compact manifold rail

For 2x 3/2-way valves

Both valve functions per valve position simultaneously in open switching position

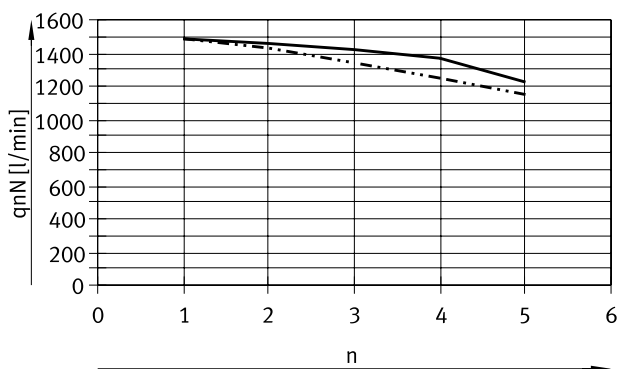

— Standard nominal flow rate per valve on standard manifold rail

- - - Standard nominal flow rate per valve on compact manifold rail

Key features – Pneumatic components VUWS-LT

Size 30 – Standard nominal flow rate q_{nN} , with several valves n switched in parallel

For 3/2-way valves

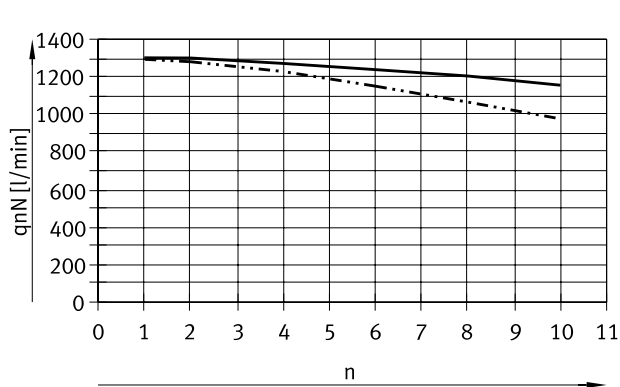

- Standard nominal flow rate per valve on standard manifold rail
- - - Standard nominal flow rate per valve on compact manifold rail

For 5/2-way valves, flow direction 1 → 2

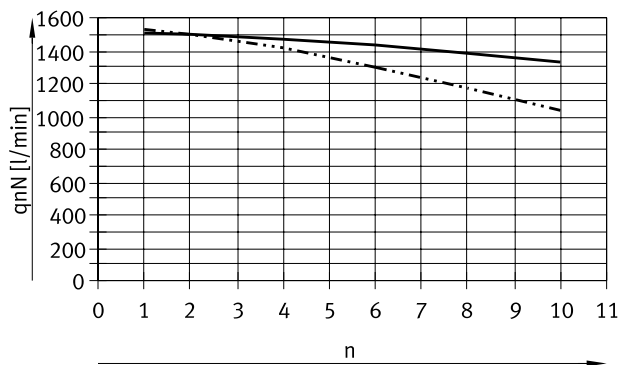

- Standard nominal flow rate per valve on standard manifold rail
- - - Standard nominal flow rate per valve on compact manifold rail

For 5/2-way valves, flow direction 1 → 4

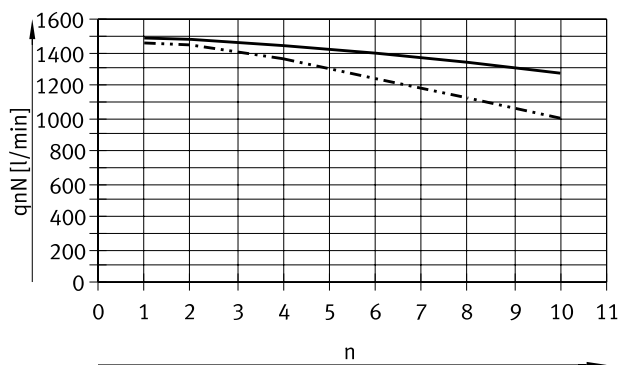

- Standard nominal flow rate per valve on standard manifold rail
- - - Standard nominal flow rate per valve on compact manifold rail

Key features – Pneumatic components VUWS-LT

Size 30 – Standard nominal flow rate q_{nN} , with several valves n switched in parallel

For 2x 3/2-way valves

One valve function per valve position in open switching position

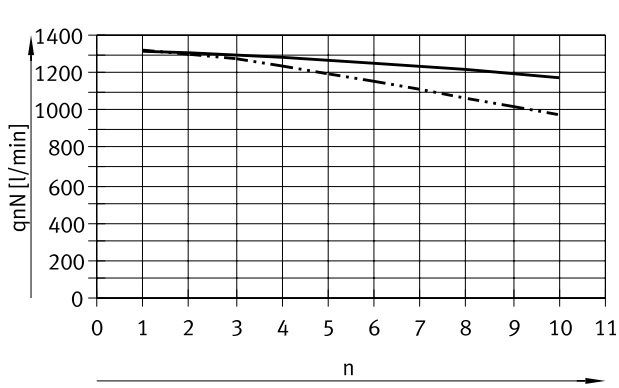

— Standard nominal flow rate per valve on standard manifold rail

- - - Standard nominal flow rate per valve on compact manifold rail

For 2x 3/2-way valves

Both valve functions per valve position simultaneously in open switching position

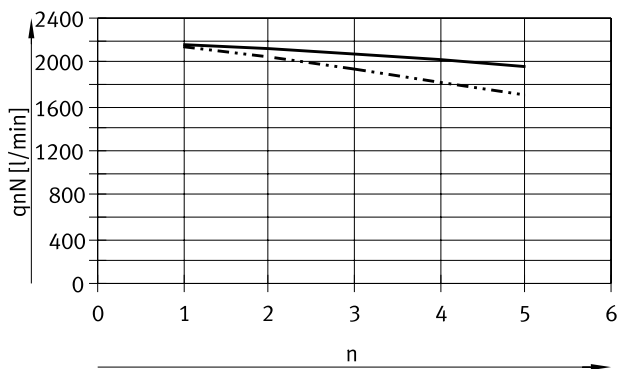

— Standard nominal flow rate per valve on standard manifold rail

- - - Standard nominal flow rate per valve on compact manifold rail

Key features – Pneumatic components VUWS-L

Size 20 – Standard nominal flow rate q_{nN} , with several valves n switched in parallel

For 3/2-way valves

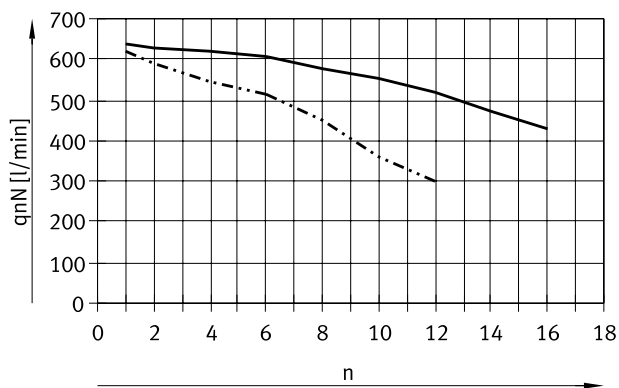

— Standard nominal flow rate per valve on standard manifold rail
 - · - · - · Standard nominal flow rate per valve on compact manifold rail

For 5/2- and 5/3-way valves

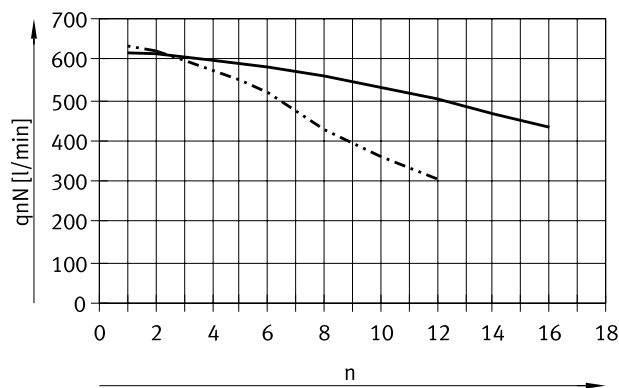

— Standard nominal flow rate per valve on standard manifold rail
 - · - · - · Standard nominal flow rate per valve on compact manifold rail

Size 25 – Standard nominal flow rate q_{nN} , with several valves n switched in parallel

For 3/2-way valves

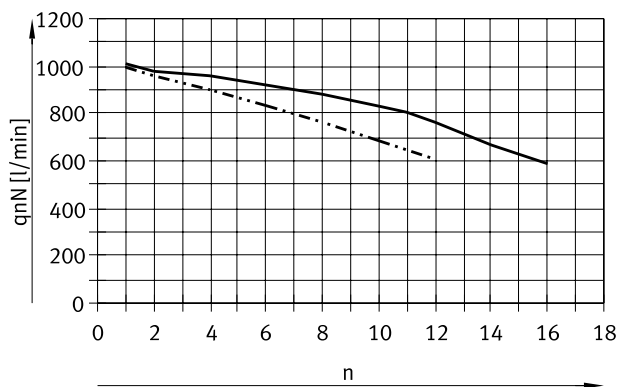

— Standard nominal flow rate per valve on standard manifold rail
 - · - · - · Standard nominal flow rate per valve on compact manifold rail

For 5/2- and 5/3-way valves

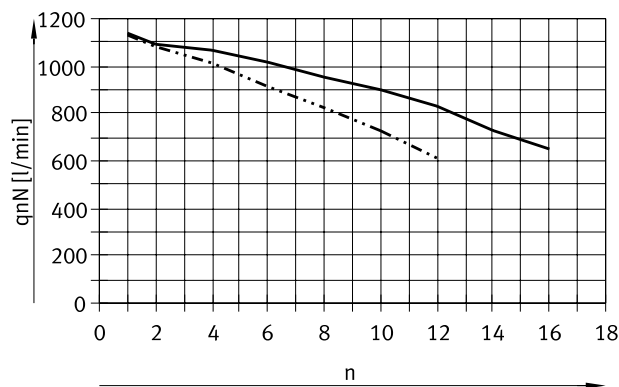

— Standard nominal flow rate per valve on standard manifold rail
 - · - · - · Standard nominal flow rate per valve on compact manifold rail

Key features – Pneumatic components VUWS-L

Size 30 – Standard nominal flow rate q_{nN} , with several valves n switched in parallel

For 3/2-way valves

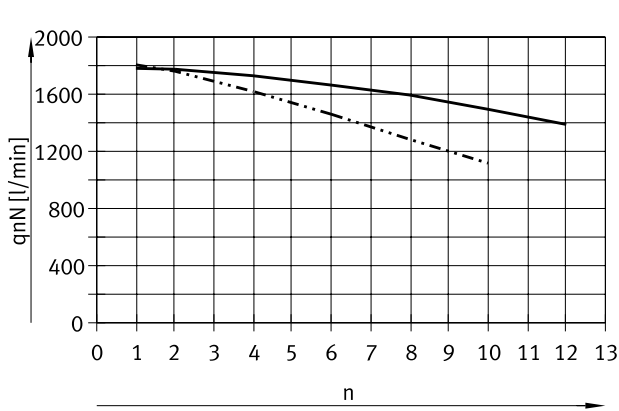

- Standard nominal flow rate per valve on standard manifold rail
- - - Standard nominal flow rate per valve on compact manifold rail

For 5/2- and 5/3-way valves

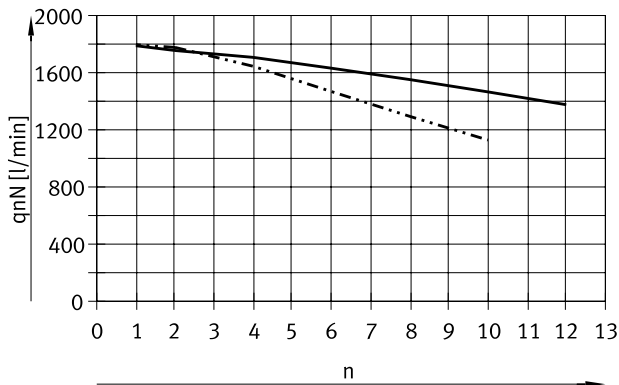

- Standard nominal flow rate per valve on standard manifold rail
- - - Standard nominal flow rate per valve on compact manifold rail

Key features – Pneumatic components VUWS-LT

Size 20 – Pilot pressure p_2 as a function of working pressure p_1

For 3/2-way valves

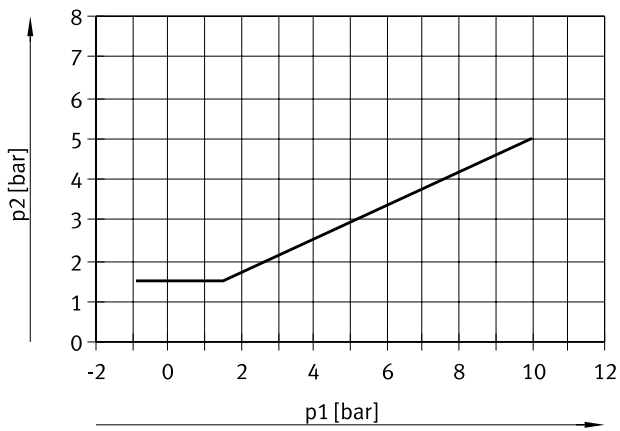
**Size 25 – Pilot pressure p_2 as a function of working pressure p_1**

For 3/2-way valves

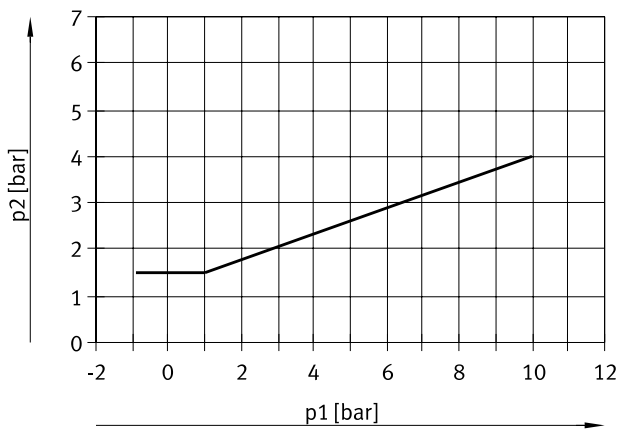

Key features – Pneumatic components VUWS-LT

Size 30 – Pilot pressure p_2 as a function of working pressure p_1

For 3/2-way valves

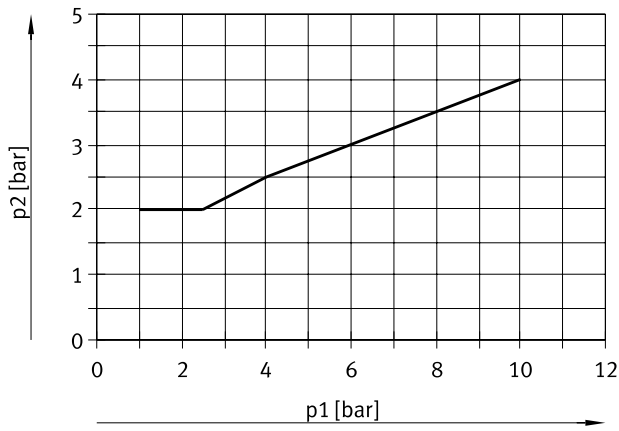

For 5/2-way monostable valves

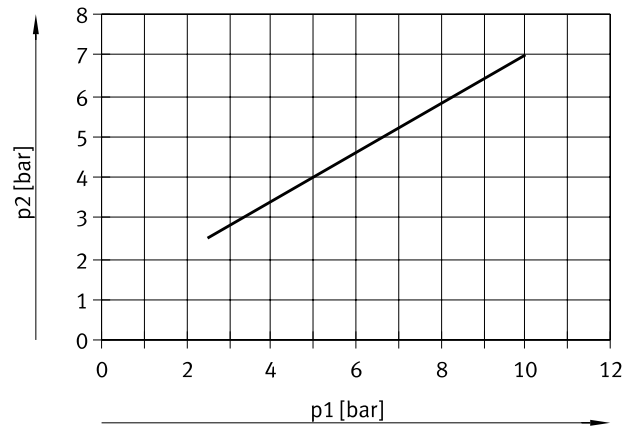

For 5/2-way bistable valves

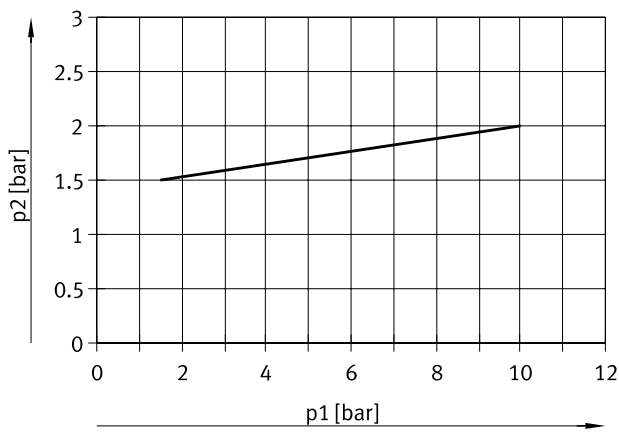

Key features – Mounting

Mounting the valve manifold assembly

- Sturdy manifold assembly thanks to:
- Four through-holes for wall mounting
 - H-rail mounting

 **Note**

Use the thread M4 (M5 for size 30) provided on the manifold block for earthing the valve manifold assembly.

Wall mounting

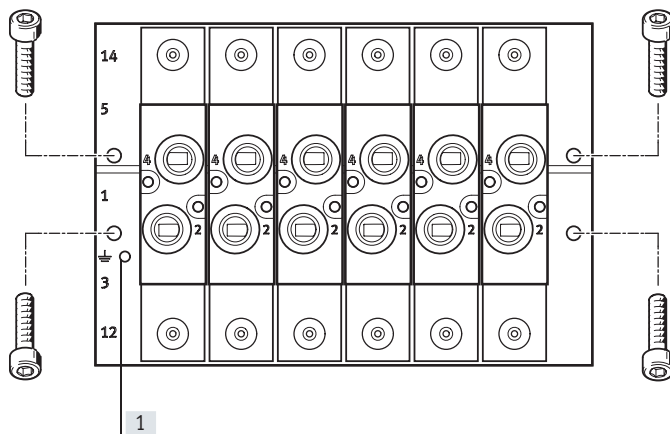

Sturdy wall mounting of the manifold block using four through-holes.

[1] Earth terminal

H-rail mounting

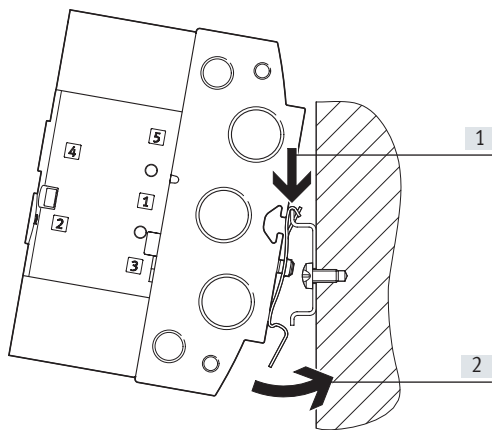

The H-rail mounting VAME-T-M... consists of two mounting clips. These are screwed to the manifold block on the left and right.

The manifold block is then lowered onto the H-rail from above (arrow A) and clipped into the H-rail at the bottom (arrow B).

 **Note**

- Note the max. tightening torque of the screws for H-rail mounting.
- Only horizontal H-rail mounting is permissible
- Mounting only permissible on H-rail TH 35-... to EN 60715
- Vibration/shock loads are not permissible with H-rail mounting.
- Further note on assembly
→ Assembly instructions for H-rail mounting VAME-T-M...

Key features – Mounting

Mounting individual valve VUWS

Wall mounting

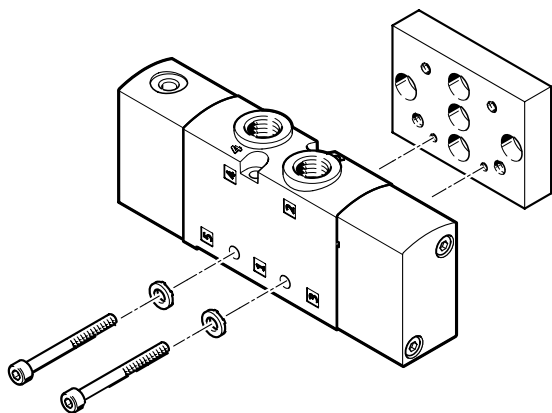

For mounting individual valves on a flat surface, e.g. aluminium profile systems.
The pneumatic valves are provided with two through-holes for attaching to the wall mounting VAME-B10-20-W.

The screw set required is included with the wall mounting VAME-B10-20-W.
The wall mounting VAME-B10-20-W can be used for sizes 20, 25 and 30.

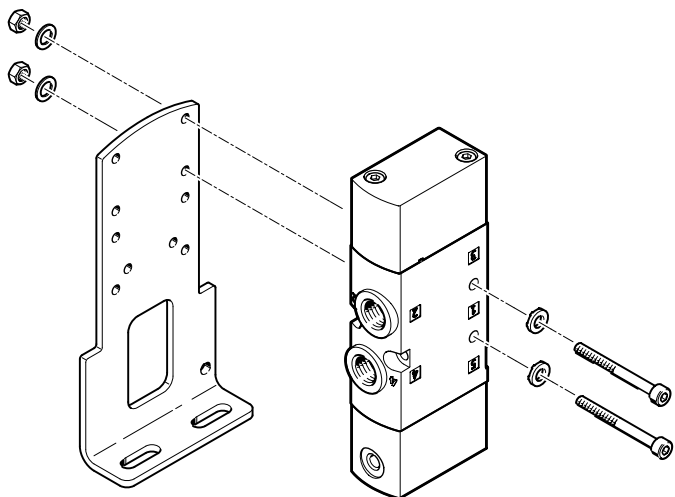

For mounting individual valves on a flat surface, e.g. aluminium profile systems.
The pneumatic valves are provided with two through-holes for attaching to the foot mounting VAME-B10-...-A.

The screw set required is included with the foot mounting VAME-B10-...-A.

Note

Further mounting options for foot mounting VAME-B10-...

→ Data sheet – Pneumatic valves, dimensions

Product range overview

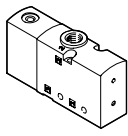
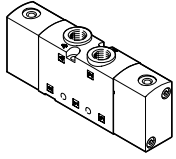
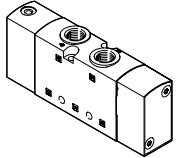
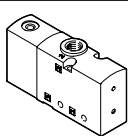
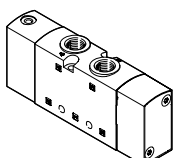
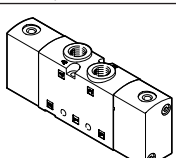
Design type	Size	Working port	Order code for valves and flow rate [l/min]										→ Page/ Internet
			M32C	M32U	T32C	T32U	T32H	M52	B52	P53C	P53E	P53U	
3/2-way valve VUWS-LT													
	20	1/8 NPT	600	600	-	-	-	-	-	-	-	-	40
	25	1/4 NPT	1000	1000	-	-	-	-	-	-	-	-	49
	30	3/8 NPT	1600	1600	-	-	-	-	-	-	-	-	58
2x 3/2-way valve VUWS-LT													
	20	1/8 NPT	-	-	600	600	600	-	-	-	-	-	40
	25	1/4 NPT	-	-	1000	1000	1000	-	-	-	-	-	49
	30	3/8 NPT	-	-	1600	1600	1600	-	-	-	-	-	58
5/2-way valve VUWS-LT													
	20	1/8 NPT	-	-	-	-	-	500	500	-	-	-	40
	25	1/4 NPT	-	-	-	-	-	1000	1000	-	-	-	49
	30	3/8 NPT	-	-	-	-	-	1800	1800	-	-	-	58
3/2-way valve VUWS-L													
	20	1/8 NPT	700	700	-	-	-	-	-	-	-	-	67
	25	1/4 NPT	1000	1000	-	-	-	-	-	-	-	-	76
	30	3/8 NPT	2300	2300	-	-	-	-	-	-	-	-	85
5/2-way valve VUWS-L													
	20	1/8 NPT	-	-	-	-	-	700	700	-	-	-	67
	25	1/4 NPT	-	-	-	-	-	1300	1300	-	-	-	76
	30	3/8 NPT	-	-	-	-	-	2300	2300	-	-	-	85
5/3-way valve VUWS-L													
	20	1/8 NPT	-	-	-	-	-	-	-	700	600	600	67
	25	1/4 NPT	-	-	-	-	-	-	-	1200	1000	1000	76
	30	3/8 NPT	-	-	-	-	-	-	-	2000	1600	1600	85

Product range overview

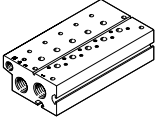
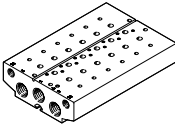
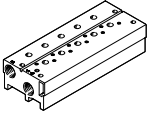
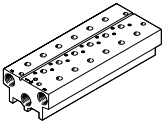
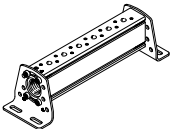
Design type	Size	Description		→ Page/ Internet
Manifold block for 3/2-way valves, standard				
	20	VABM-B10-20E-N38- ... -P3	Connection size 3/8 NPT	99
	25	VABM-B10-25E-N12- ... -P3	Connection size 1/2 NPT	110
	30	VABM-B10-30E-N34- ... -P3	Connection size 3/4 NPT	121
Manifold block for 5/2- and 5/3-way valves, standard				
	20	VABM-B10-20E-N38- ...	Connection size 3/8 NPT	99
	25	VABM-B10-25E-N12- ...	Connection size 1/2 NPT	110
	30	VABM-B10-30E-N34- ...	Connection size 3/4 NPT	121
Manifold block for 3/2-way valves, compact				
	20	VABM-B10-20S-N14- ...-P3	Connection size 1/4 NPT	99
	25	VABM-B10-25S-N38- ...-P3	Connection size 3/8 NPT	110
	30	VABM-B10-30S-N12- ...-P3	Connection size 1/2 NPT	121
Manifold block for 5/2- and 5/3-way valves, compact				
	20	VABM-B10-20S-N14- ...	Connection size 1/4 NPT	99
	25	VABM-B10-25S-N38- ...	Connection size 3/8 NPT	110
	30	VABM-B10-30S-N12- ...	Connection size 1/2 NPT	121
Common supply manifold, for mounting on both sides				
	20	VABM-B10-20-N38- ... -P53	Connection size 3/8 NPT	99
	25	VABM-B10-25-N12- ... -P53	Connection size 1/2 NPT	110
	30	VABM-B10-30-N34- ... -P53	Connection size 3/4 NPT	121

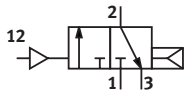
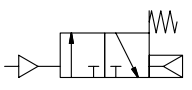
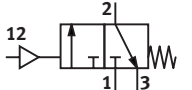
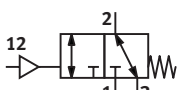
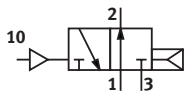
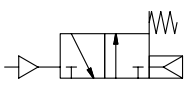
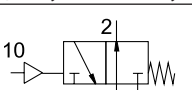
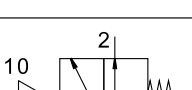

Valve function

Valve	Order code for valves	Description	VUWS-LT			VUWS-L		
			Size			Size		
			20	25	30	20	25	30
3/2-way valve, normally closed, pneumatic spring								
	M32C-A	<ul style="list-style-type: none"> Internal pneumatic spring supply Flow direction: not reversible 	-	-	-	■	■	■
3/2-way valve, normally closed, pneumatic/mechanical spring								
	M32C-M	<ul style="list-style-type: none"> Flow direction: not reversible Reset: mechanical spring, supported internally by pneumatic spring 	-	-	-	■	-	-
3/2-way valve, normally closed, mechanical spring								
	M32C-M	Flow direction: not reversible	■	■	■	-	-	-
	M32C-M	Flow direction: reversible	-	-	-	-	■	■
3/2-way valve, normally open, pneumatic spring								
	M32U-A	<ul style="list-style-type: none"> Internal pneumatic spring supply Flow direction: not reversible Reset: pneumatic spring 	-	-	-	■	■	■
3/2-way valve, normally open, pneumatic/mechanical spring								
	M32U-M	<ul style="list-style-type: none"> Flow direction: not reversible Reset: mechanical spring, supported internally by pneumatic spring 	-	-	-	■	-	-
3/2-way valve, normally open, mechanical spring								
	M32U-M	Flow direction: not reversible	■	■	■	-	-	-
	M32U-M	Flow direction: reversible	-	-	-	-	■	■

Valve function

Valve	Order code for valves	Description	VUWS-LT			VUWS-L		
			Size			Size		
			20	25	30	20	25	30
2x 3/2-way valve, normally closed, mechanical spring								
	T32C	<ul style="list-style-type: none"> Internal pilot air supply Flow direction: not reversible 	■	■	■	-	-	-
2x 3/2-way valve, normally open, mechanical spring								
	T32U	<ul style="list-style-type: none"> Internal pilot air supply Flow direction: not reversible 	■	■	■	-	-	-
2x 3/2-way valve, 1x normally open, 1x normally closed, mechanical spring								
	T32H	<ul style="list-style-type: none"> Internal pilot air supply Flow direction: not reversible 	■	■	■	-	-	-

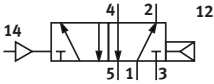
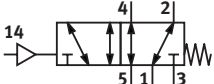
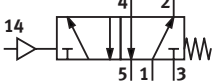
Valve function

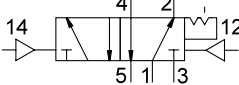
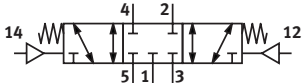
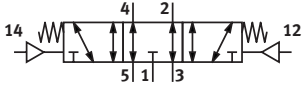
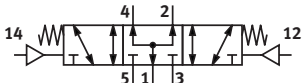
Valve	Order code for valves	Description	VUWS-LT			VUWS-L		
			Size			Size		
			20	25	30	20	25	30
5/2-way valve, pneumatic spring, monostable								
	M52-A	<ul style="list-style-type: none"> Internal pneumatic spring supply Flow direction: not reversible 	-	-	-	■	■	■
5/2-way valve, mechanical spring, monostable								
	M52-M	Flow direction: reversible	-	-	-	■	■	■
	M52-M	Flow direction: not reversible	■	■	■	-	-	-
5/2-way bistable valve								
	B52	Flow direction: reversible	-	-	-	■	■	■
	B52	<ul style="list-style-type: none"> Flow direction: not reversible Holding the switching position: via latch 	■	■	■	-	-	-
5/3-way valve, mid-position closed								
	P53C	Flow direction: reversible	-	-	-	■	■	■
5/3-way valve, mid-position exhausted								
	P53E	Flow direction: reversible	-	-	-	■	■	■
5/3-way valve, mid-position pressurised								
	P53U	Flow direction: reversible	-	-	-	■	■	■

Peripherals overview VUWS-LT, VUWS-L

Manifold block for 3/2-way valves

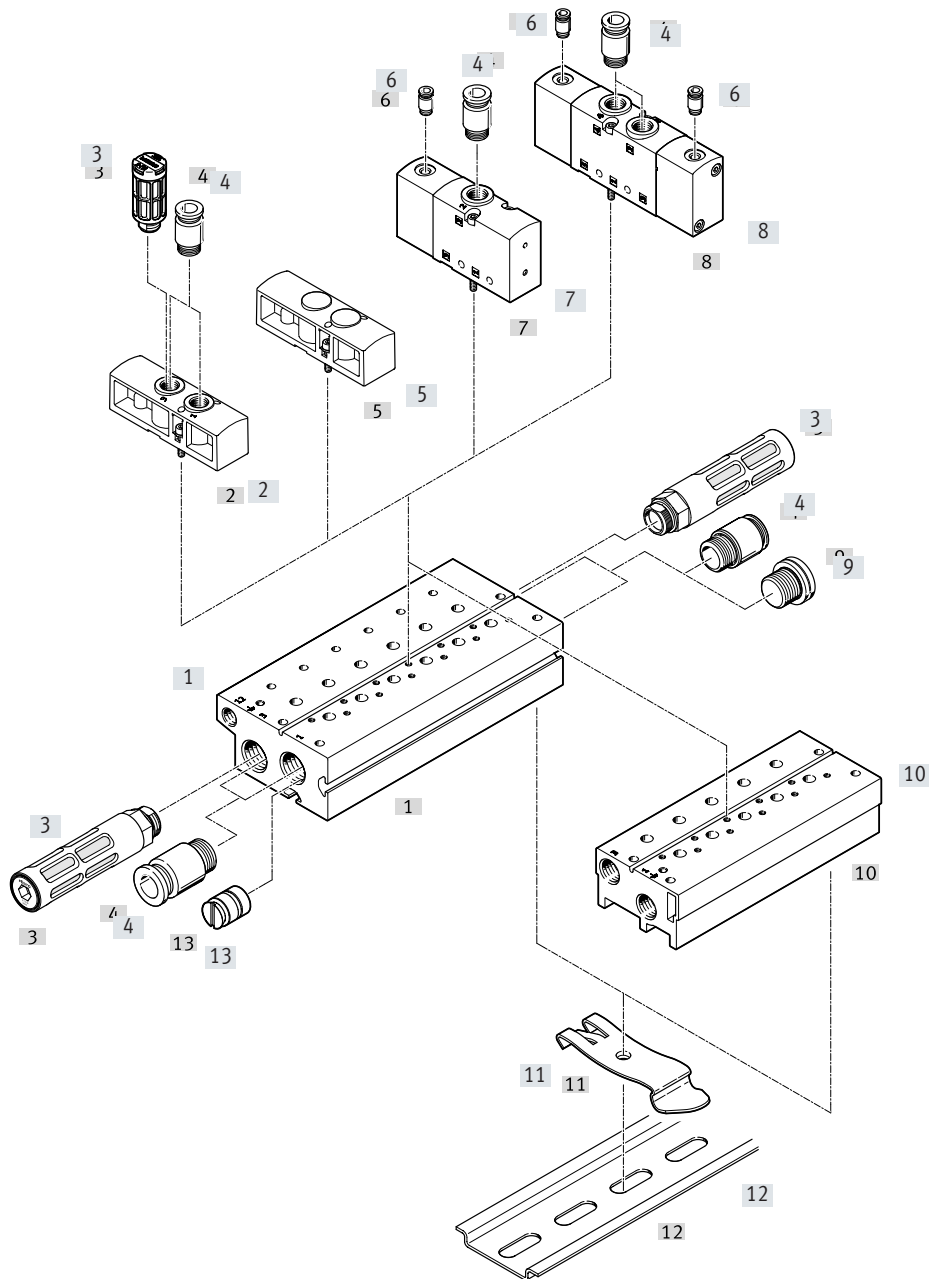

Accessories		
Designation	Brief description	→ Page/Internet
[1] Standard manifold block	For 3/2-way valves	99
[2] Supply plate	For 3/2-way valves	100
[3] Silencer	For exhaust ports (3)	102
[4] Push-in fitting	For supply/exhaust ports (1, 3)	100
[5] Blanking plate	VABB-B10-...	100
[6] Push-in fitting	For pilot air port	100
[7] Pneumatic valve	3/2-way valve	56
[8] Pneumatic valve	2x 3/2-way valve (VUWS-LT...)	56
[9] Blanking plug	For supply/exhaust ports (1, 3)	103
[10] Compact manifold block	For 3/2-way valves	99
[11] H-rail mounting	For mounting on standard H-rails	103
[12] Standard H-rail	Mounting rail to EN 60715	-
[13] Separator	For creating pressure zones (in duct 1 and/or 3)	103

Peripherals overview VUWS-LT, VUWS-L

Manifold block for 5/2 and 5/3-way valves

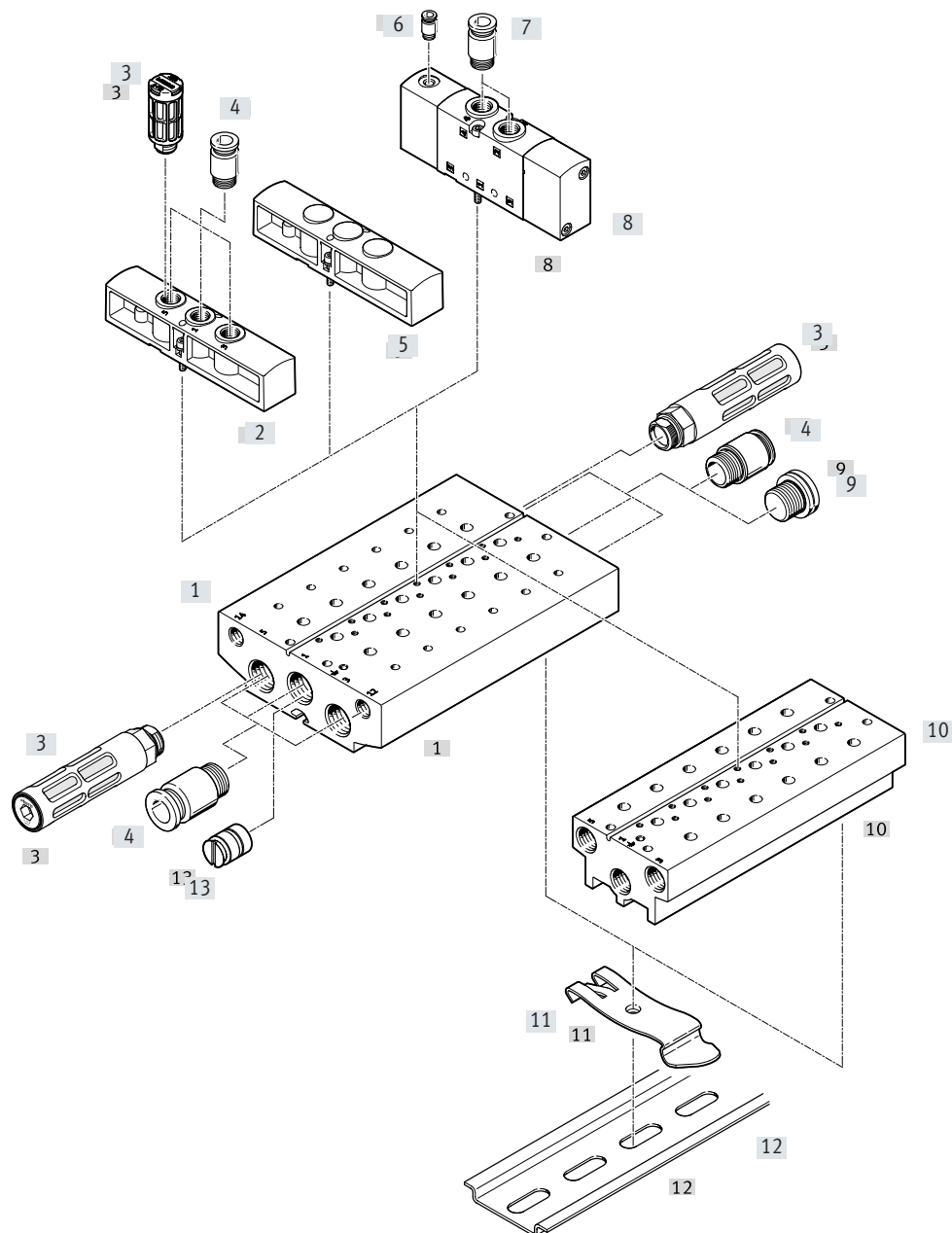

Accessories			
Designation		Brief description	→ Page/Internet
[1]	Standard manifold block	For 5/2- and 5/3-way valves	99
[2]	Supply plate	For 5/2- and 5/3-way valves	100
[3]	Silencer	For exhaust ports (5 and/or 3)	102
[4]	Push-in fitting	For supply/exhaust ports (1, 3, 5)	100
[5]	Blanking plate	VABB-B10-...	100
[6]	Push-in fitting	For pilot air port	100
[7]	Push-in fitting	For working ports (2, 4)	100
[8]	Pneumatic valve	5/2-way, 5/3-way valve	56
[9]	Blanking plug	For supply/exhaust ports (1, 3, 5)	103
[10]	Compact manifold block	For 5/2- and 5/3-way valves	99
[11]	H-rail mounting	For mounting on standard H-rails	103
[12]	Standard H-rail	Mounting rail to EN 60715	-
[13]	Separator	For creating pressure zones (in ducts 1, 3, 5)	103

Peripherals overview VUWS-LT, VUWS-L

Common supply manifold for mounting on both sides

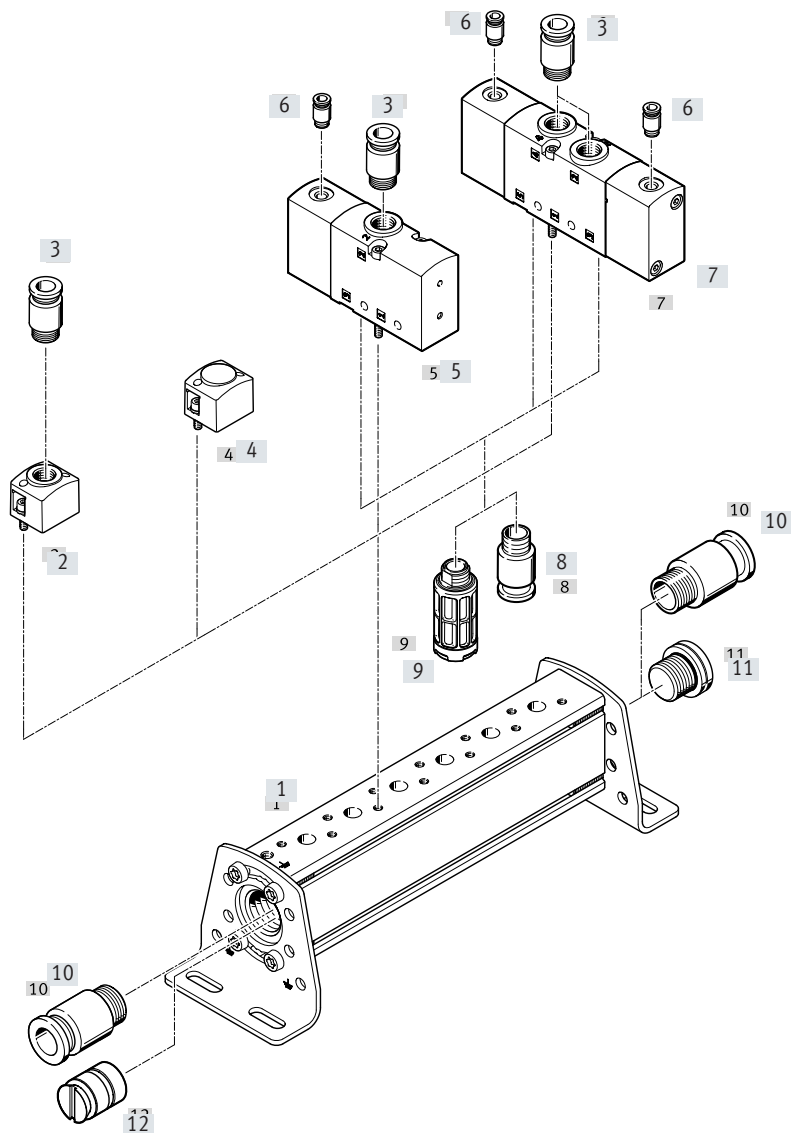

Accessories			
Designation		Brief description	→ Page/Internet
[1]	Common supply manifold	For mounting on both sides Mounting bracket can be adjusted through $\pm 30^\circ$.	99
[2]	Air supply plate/supply plate	For supplying working air (1) (VABF-B10-...-P1...)	100
[3]	Push-in fitting	For supplying air (1) for working ports (2, 4)	100
[4]	Blanking plate	VABB-B10-...	100
[5]	Pneumatic valve	3/2-way valve	56
[6]	Push-in fitting	For pilot air port	100
[7]	Pneumatic valve	5/2-way, 5/3-way valve 2x 3/2-way valve (VUWS-LT...)	56 56
[8]	Push-in fitting	For exhaust ports (3, 5)	100
[9]	Silencer	For exhaust ports (3, 5)	102
[10]	Push-in fitting	For supplying air (1)	100
[11]	Blanking plug	For working port (duct 1)	103
[12]	Separator	For creating pressure zones (in duct 1)	103

Data sheet – Valve manifold assembly

-  - Flow rate
 Size 20:
 up to 700 l/min
 Size 25:
 up to 1300 l/min
 Size 30
 up to 2300 l/min



General technical data			20	25	30
Size			20	25	30
Valve manifold design			Fixed grid		
Valve width		[mm]	21	26.5	31
Valve design	VUWS-L		Piston spool	Piston spool	Piston spool
	VUWS-LT		Poppet seat	Poppet seat	Poppet seat
Reset method for valves	VUWS-L		Pneumatic or mechanical spring		
	VUWS-LT		Mechanical spring		
Pneumatic spring			Internal or external		
Flow direction	VUWS-L		Reversible with restrictions		
	VUWS-LT		Non-reversible		
Suitable for vacuum	VUWS-L		Yes, with restrictions		
	VUWS-LT		Yes, with restrictions		No
Type of control			Direct		
Manual override (MO)			None		
Overlap	VUWS-L		Positive overlap		
	VUWS-LT		Negative overlap		
Sealing principle			Soft		
Max. no. of valve positions			16 (a maximum of 18 valve positions with extension for standard manifold block)		
Max. number of pressure zones			9		
Exhaust air function			Can be throttled		
Actuation type			Pneumatic		
Standard nominal flow rate [qnN]		[l/min]	600...700	1000...1300	1600...2300
Pilot air connection	Standard manifold block	12/14	1/8 NPT		
	Compact manifold block	12/14	On the valve		
	Common supply manifold	12/14	On the valve		
Pilot exhaust air port		82/84	10-32 UNF-2B		
Mounting position			Any		
Corrosion resistance class CRC ¹⁾			2		
Note on materials			RoHS-compliant		
Information on materials: seals	VUWS-L		HNBR, NBR		
	VUWS-LT		HNBR, NBR, TPE-U(PU)		

1) More information: www.festo.com/x/topic/kbk

Data sheet – Valve manifold assembly

ATEX							
ATEX category gas	II 3G						
Type of ignition protection for gas	Ex ec IICT4 X Gc						
ATEX category for dust	II 3D						
Type of ignition protection for dust	Ex tc IIIC T115°C X Dc						
Explosion-proof ambient temperature [°C]	-10 ... +60						
CE marking (see declaration of conformity)	To EU Explosion Protection Directive (ATEX)						
Operating and environmental conditions							
Valve design	Piston spool			Poppet seat			
Size	20	25	30	20	25	30	
Operating medium	Compressed air to ISO 8573-1:2010 [7:4:4]						
Pilot medium	Compressed air to ISO 8573-1:2010 [7:4:4]						
Note on the operating/pilot medium	Lubricated operation possible (in which case lubricated operation will always be required)						
Operating pressure [MPa]	-0.09 ... +1	-0.09 ... +1	-0.09 ... +1	-0.09 ... +1 (M32, T32)	-0.09 ... +1 (M32, T32)	-	
	-	-	-	-	-	+0.1 ... +1 (32)	
	-	-	-	+0.15 ... +1 (B52)	+0.15 ... +1 (B52)	+0.15 ... +1 (B52)	
	+0.25 ... +1 (M32...-A, M32...-M, M52-A)	+0.25 ... +1 (M...-A, M52)	+0.25 ... +1 (M...-A)	+0.25 ... +1 (M52)	+0.25 ... +1 (M52)	+0.25 ... +1 (M52)	
	[bar]	-0.9 ... +10	-0.9 ... +10	-0.9 ... +10	-0.9 ... +10 (M32, T32)	-0.9 ... +10 (M32, T32)	-
	-	-	-	-	-	+1.0 ... +10 (32)	
	-	-	-	+1.5 ... +10 (B52)	+1.5 ... +10 (B52)	+1.5 ... +10 (B52)	
Pilot pressure [MPa]	0.15 ... 1 (B52)	0.15 ... 1 (B52)	0.15 ... 1 (B52)	0.15 ... 1	0.15 ... 1 (B52)	0.15 ... 1 (B52)	
	0.25 ... 1	0.25 ... 1	0.25 ... 1	0.25 ... 1 (M52)	0.25 ... 1	0.25 ... 1	
	[bar]	1.5 ... 10 (B52)	1.5 ... 10 (B52)	1.5 ... 10 (B52)	1.5 ... 10	1.5 ... 10 (B52)	
	2.5 ... 10	2.5 ... 10	2.5 ... 10	2.5 ... 10 (M52)	2.5 ... 10	2.5 ... 10	
Ambient temperature [°C]	-10 ... +60						
Temperature of medium [°C]	-10 ... +60						
Certification	c UL us - Recognized (OL)						

Data sheet – Valve manifold assembly

Dimensions

Download CAD data → www.festo.com

With 3/2-way valves, standard manifold rail

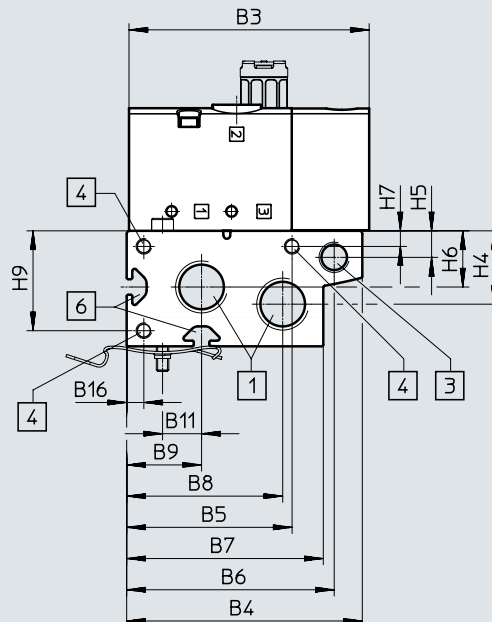
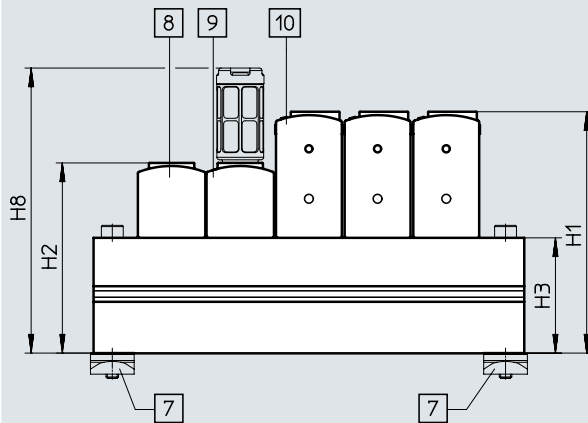
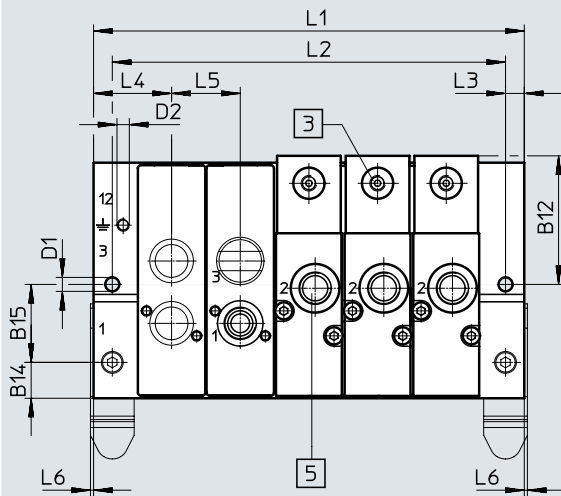

- | | | | |
|--|---|---|---|
| [1] Port 1 and 3 (at both ends):
3/8 NPT for VTUS 20,
1/2 NPT for VTUS 25,
3/4 NPT for VTUS 30 | [4] Thread for extension module:
M5x15.5 for VTUS 20,
M5x18 for VTUS 25,
M5x18 for VTUS 30 | [6] Profile slot IPM-05, system 5 | [9] Supply plate, port 1 and 3:
G1/8 for VTUS 20
G1/4 for VTUS 25
G3/8 for VTUS 30 |
| [3] Port 12 on the manifold block at both ends: 1/8 NPT
Port 10 and 12 on the valve:
10-32 UNF-2B for VTUS 20,
10-32 UNF-2B for VTUS 25,
1/8 NPT for VTUS 30 | [5] Port 2:
1/8 NPT for VTUS 20,
1/4 NPT for VTUS 25,
3/4 NPT for VTUS 30 | [7] H-rail mounting VAME-T-M4 for VTUS 20, VAME-T-M5 for VTUS 25, VAME-T-M6 for VTUS 30 | [10] 3/2-way valve |
| | | [8] Blanking plate | |

 **Note**

Port 12 on the manifold rail (number 3 in the dimensional drawing) is not used when equipped with pneumatic valves.

Data sheet – Valve manifold assembly

Type	B3	B4	B5	B6	B7	B8	B9	B11	B12	B14	B15	B16
VTUS-20	77	75.5	53	66.5	63	50	24	12.5	41.2	11.5	25	5.5
VTUS-25	92	93	67.5	80.5	78	62	30	16	–	14	32	6
VTUS-30	109.2	108.2	79	93.2	94.7	75.7	36.2	19	55.5	17.2	38	6.5

Type	D1 ø	D2	H1	H2	H3	H4	H5	H6	H7	H8	H9	L3	L4	L5	L6
VTUS-20	4.5	M4x6.5	77.4	61	37	23.5	8.5	18	5	91.4	32	6	25	22	1
VTUS-25	5.5	M4x9	95.5	71	45	25	9	22	5	123.4	39	6	29.8	27.5	1
VTUS-30	6.3	M5x11	118	91	61	35	9	28.5	6.5	170.1	54.5	7.2	34	32	–

Valve positions		2	3	4	5	6	7	8	9	10
VTUS-20	L1 [mm]	72	94	116	138	160	182	204	226	248
	L2 [mm]	60	82	104	126	148	170	192	214	236
VTUS-25	L1 [mm]	87	114.5	142	169.5	197	224.5	252	279.5	307
	L2 [mm]	75	102.5	130	157.5	185	212.5	240	267.5	295
VTUS-30	L1 [mm]	100	132	164	196	228	260	292	324	356
	L2 [mm]	85	117	149	181	213	245	277	309	341

Data sheet – Valve manifold assembly

Dimensions – Valve manifold assembly

Download CAD data → www.festo.com

With 3/2-way valves, compact manifold rail

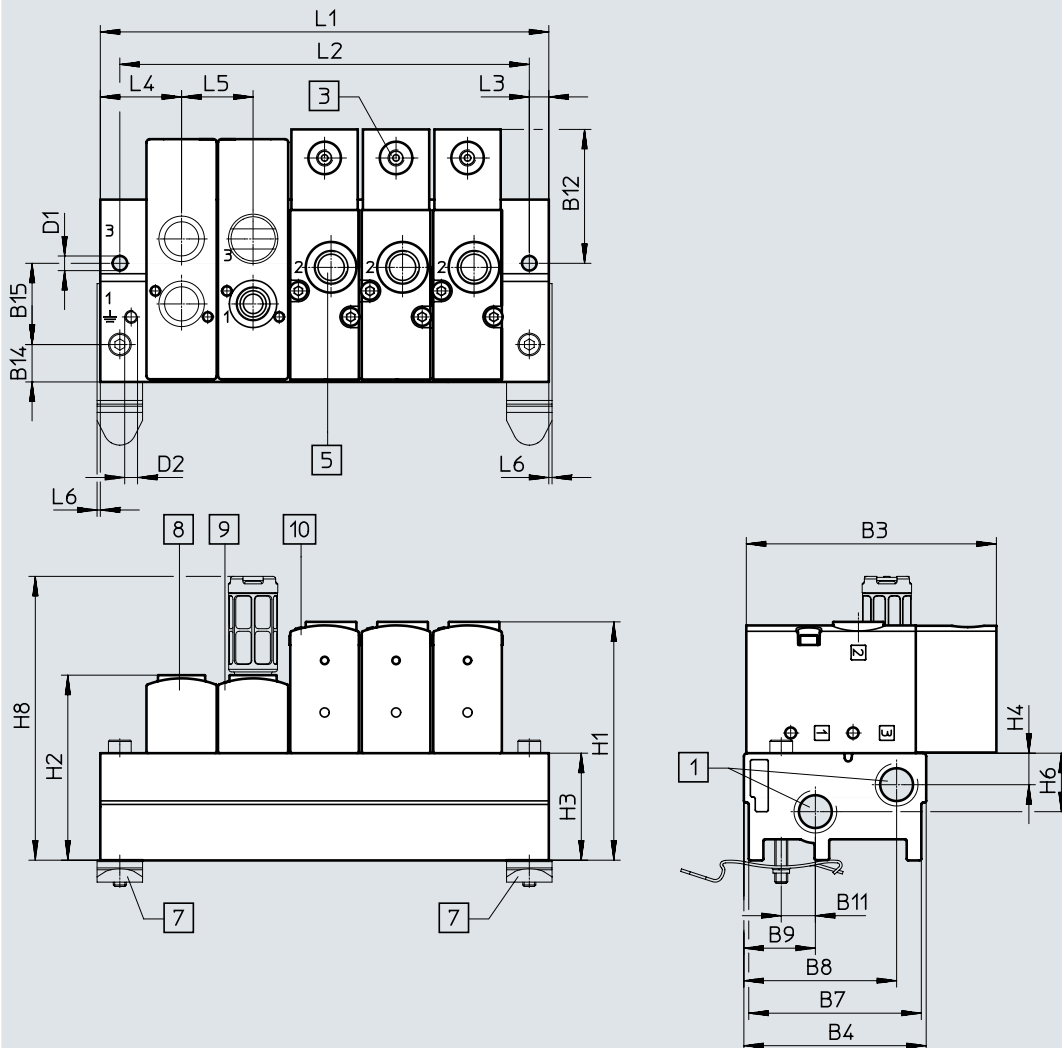

[1] Port 1 and 3 (at both ends):
 1/4 NPT for VTUS 20,
 3/8 NPT for VTUS 25,
 1/2 NPT for VTUS 30

[3] Port 10 and 12 on the valve:
 10-32 UNF-2B for VTUS 20,
 10-32 UNF-2B for VTUS 25,
 1/8 NPT for VTUS 30

[5] Port 2:
 1/8 NPT for VTUS 20,
 1/4 NPT for VTUS 25,
 3/8 NPT for VTUS 30

[7] H-rail mounting VAME-T-M4
 for VTUS 20, VAME-T-M5
 for VTUS 25, VAME-T-M6
 for VTUS 30

[8] Blanking plate
 [9] Supply plate, port 1 and 3:
 G1/8 for VTUS 20
 G1/4 for VTUS 25
 G3/8 for VTUS 30

[10] 3/2-way valve

Data sheet – Valve manifold assembly

Type	B3	B4	B7	B8	B9	B11	B12	B14	B15
VTUS-20	77	56.1	53.1	47	22	10.5	41.2	11.5	25
VTUS-25	92	70.3	67.3	58.8	30	16	47	14	32
VTUS-30	109.2	83	80	69.4	36	19	55.5	17	38

Type	D1 ø	D2	H1	H2	H3	H4	H6	H8	L3	L4	L5	L6
VTUS-20	4.5	M4x6.5	73.4	57	33	9.7	18	87.4	6	25	22	1
VTUS-25	5.5	M4x9	84.5	60	34	13.5	20	112.4	6	29.8	27.5	1
VTUS-30	6.3	M5x11	99.5	72.5	42.5	17.5	26	151.6	7.5	38	32	–

Valve positions		2	3	4	5	6	7	8	9	10
VTUS-20	L1 [mm]	72	94	116	138	160	182	204	226	248
	L2 [mm]	60	82	104	126	148	170	192	214	236
VTUS-25	L1 [mm]	87	114.5	142	169.5	197	224.5	252	279.5	307
	L2 [mm]	75	102.5	130	157.5	185	212.5	240	267.5	295
VTUS-30	L1 [mm]	100	132	164	196	228	260	292	324	356
	L2 [mm]	85	117	149	181	213	245	277	309	341

Data sheet – Valve manifold assembly

Dimensions – Valve manifold assembly

Download CAD data → www.festo.com

With 5/2-, 5/3-way and 2x 3/2-way valves, standard manifold rail

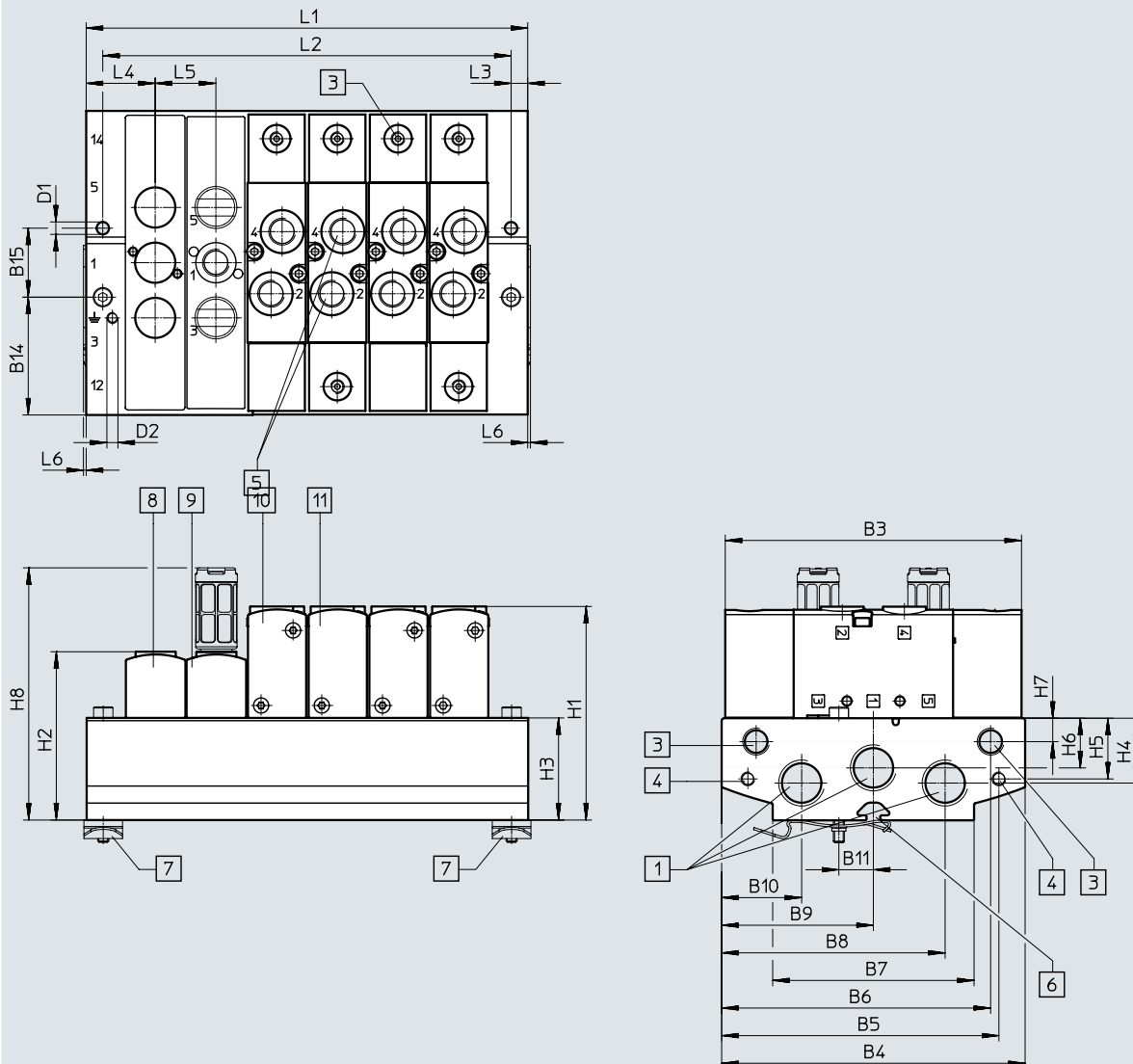

- | | | | |
|--|---|--|---|
| [1] Port 1, 3 and 5 (at both ends):
3/8 NPT for VTUS 20,
1/2 NPT for VTUS 25,
3/4 NPT for VTUS 30 | [4] Thread for extension module:
M5x15.5 for VTUS 20,
M5x18 for VTUS 25,
M5x18 for VTUS 30 | [6] Profile slot IPM-05, system 5 | [9] Supply plate. Port 1, 3 and 5:
G1/8 for VTUS 20,
G1/4 for VTUS 25,
G3/8 for VTUS 30 |
| [3] Port 12 and 14 on the manifold
block at both ends: 1/8 NPT
Port 12 and 14 on the valve:
10-32 UNF-2B for VTUS 20,
10-32 UNF-2B for VTUS 25,
1/8 NPT for VTUS 30 | [5] Port 2 and 4:
1/8 NPT for VTUS 20,
1/4 NPT for VTUS 25,
3/4 NPT for VTUS 30 | [7] H-rail mounting VAME-T-M4
for VTUS 20, VAME-T-M5
for VTUS 25, VAME-T-M6
for VTUS 30 | [10] 5/2-way monostable valve
[11] 5/2-way bistable valve or 5/3-
way valve or 2x 3/2-way valve |
| | | [8] Blanking plate | |

**Note**

Port 12 on the manifold rail (number 3 in the dimensional drawing) is not used when equipped with pneumatic valves.

Data sheet – Valve manifold assembly

Type	B3	B4	B5	B6	B7	B8	B9	B10	B11	B14	B15
VTUS-20	107.4	110	100.5	97.5	73	81	55	29	12.5	42.5	25
VTUS-25	126	126	119	113.5	80	95	63	31	16	47	32
VTUS-30	149	144	137	129	104	111.5	72	32.5	19	53	38

Type	D1 ø	D2	H1	H2	H3	H4	H5	H6	H7	H8	L3	L4	L5	L6
VTUS-20	4.5	M4x6.5	77.4	61	37	23.5	22	18	8.5	91.4	6	25	22	1
VTUS-25	5.5	M4x9	95.5	71	45	25	22	22	9	123.4	6	29.8	27.5	1
VTUS-30	6.3	M5x11	118	91	61	35	22	28.5	9	170.1	7.5	34	32	–

Valve positions		2	3	4	5	6	7	8	9	10
VTUS-20	L1 [mm]	72	94	116	138	160	182	204	226	248
	L2 [mm]	60	82	104	126	148	170	192	214	236
VTUS-25	L1 [mm]	87	114.5	142	169.5	197	224.5	252	279.5	307
	L2 [mm]	75	102.5	130	157.5	185	212.5	240	267.5	295
VTUS-30	L1 [mm]	100	132	164	196	228	260	292	324	356
	L2 [mm]	85	117	149	181	213	245	277	309	341

Data sheet – Valve manifold assembly

Dimensions – Valve manifold assembly

Download CAD data → www.festo.com

With 5/2-, 5/3-way and 2x 3/2-way valves, compact manifold rail

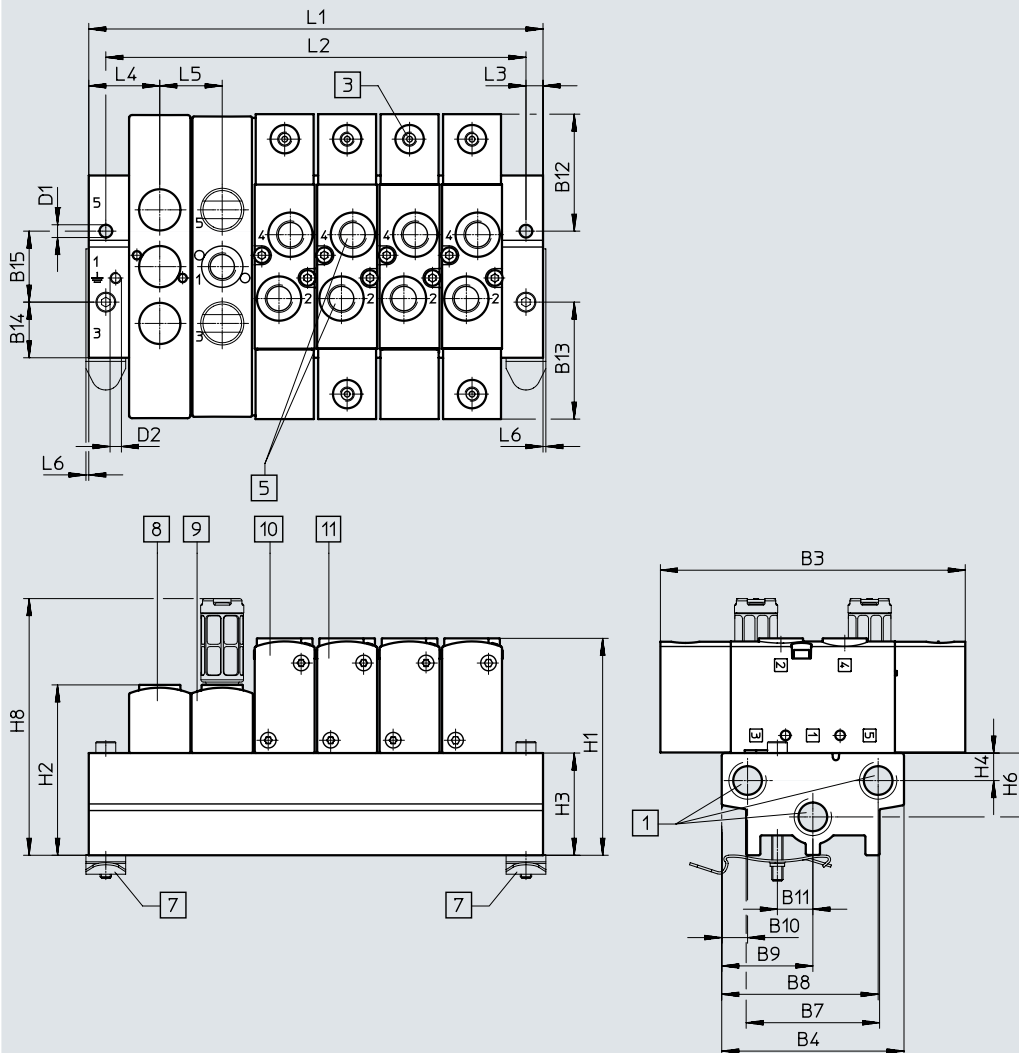

[1] Port 1, 3 and 5 (at both ends):
1/4 NPT for VTUS 20,
3/8 NPT for VTUS 25,
1/2 NPT for VTUS 30

[3] Port 12 and 14 on the valve:
10-32 UNF-2B for VTUS 20,
10-32 UNF-2B for VTUS 25,
1/8 NPT for VTUS 30

[5] Port 2 and 4:
1/8 NPT for VTUS 20,
1/4 NPT for VTUS 25,
3/8 NPT for VTUS 30

[7] H-rail mounting VAME-T-M4
for VTUS 20, VAME-T-M5
for VTUS 25, VAME-T-M6
for VTUS 30

[8] Blanking plate
[9] Supply plate, port 1, 3 and 5:
G1/8 for VTUS 20,
G1/4 for VTUS 25,
G3/8 for VTUS 30

[10] 5/2-way monostable valve
[11] 5/2-way bistable valve or 5/3-
way valve or 2x 3/2-way valve

Data sheet – Valve manifold assembly

Type	B3	B4	B7	B8	B9	B10	B11	B12	B13	B14	B15
VTUS-20	107.4	64.2	47	55.1	32.1	9.1	12.5	41.2	41.2	19.6	25
VTUS-25	126	80.5	61.5	69	40.3	11.5	16	47	47	24.3	32
VTUS-30	149	94	77	80.4	47	13.6	19	55.5	55.5	28	38

Type	D1 ø	D2	H1	H2	H3	H4	H6	H8	L3	L4	L5	L6
VTUS-20	4.5	M4x6.5	76.4	60	36	9.7	22.5	90.4	6	25	22	1
VTUS-25	5.5	M4x9	84.5	60	34	13.5	20	112.1	6	29.8	27.5	1
VTUS-30	6.3	M5x11	99.5	72.5	42.5	17.5	26	151.6	7.5	34	32	–

Valve positions		2	3	4	5	6	7	8	9	10
VTUS-20	L1 [mm]	72	94	116	138	160	182	204	226	248
	L2 [mm]	60	82	104	126	148	170	192	214	236
VTUS-25	L1 [mm]	87	114.5	142	169.5	197	224.5	252	279.5	307
	L2 [mm]	75	102.5	130	157.5	185	212.5	240	267.5	295
VTUS-30	L1 [mm]	100	132	164	196	228	260	292	324	356
	L2 [mm]	85	117	149	181	213	245	277	309	341

Data sheet – Valve manifold assembly

Dimensions – Common supply manifold

Download CAD data → www.festo.com

Mounting on both sides

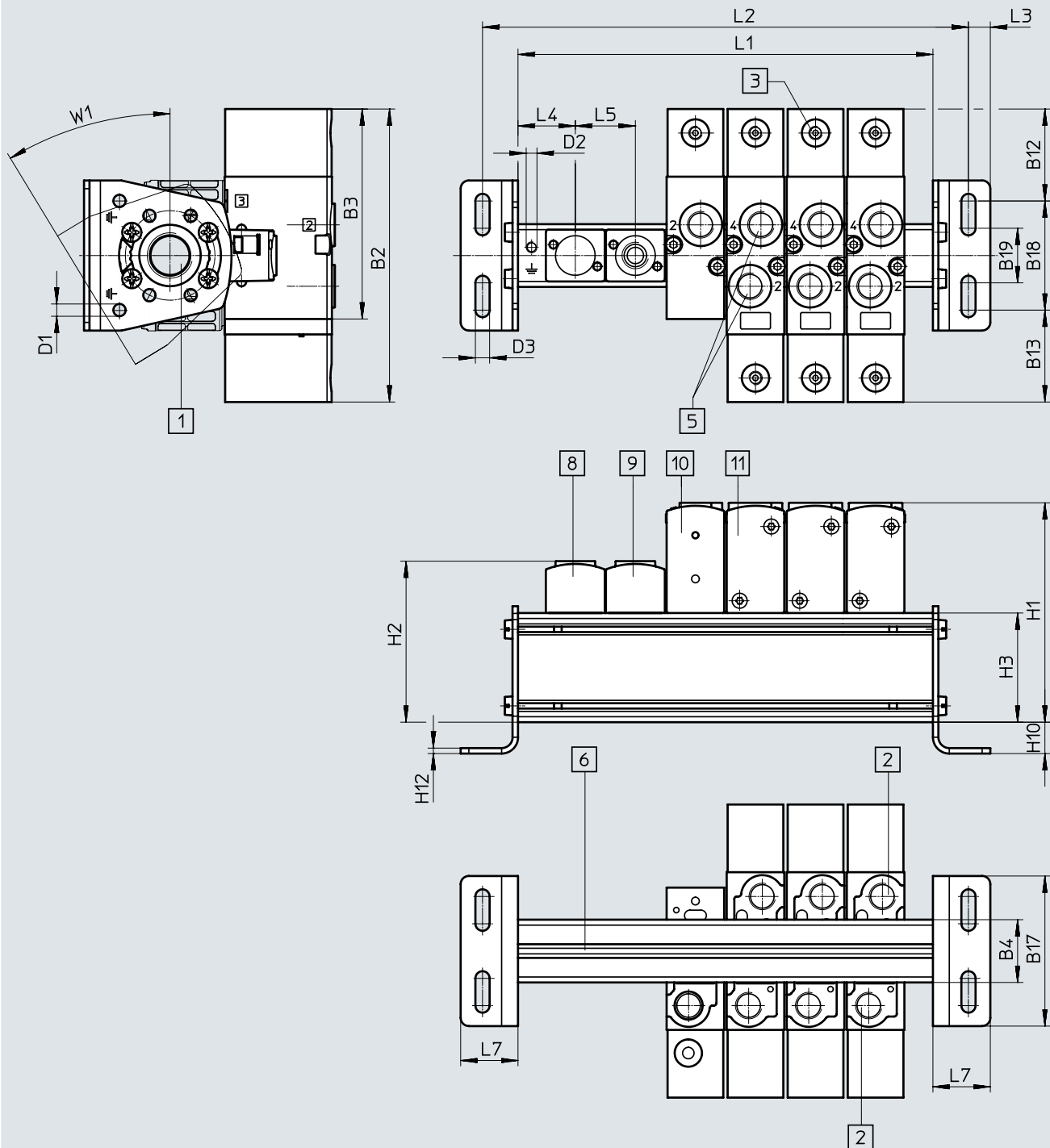

- [1] Port 1 (at both ends):
3/8 NPT for VTUS 20,
1/2 NPT for VTUS 25,
3/4 NPT for VTUS 30
- [2] Port 3 and 5:
1/8 NPT for VTUS 20,
1/4 NPT for VTUS 25,
3/8 NPT for VTUS 30

- [3] Port 12 and 14 on the valve:
10-32 UNF-2B for VTUS 20,
10-32 UNF-2B for VTUS 25,
1/8 NPT for VTUS 30
- [5] Port 2, 4:
1/8 NPT for VTUS 20, 1/4 NPT
for VTUS 25,
3/8 NPT for VTUS 30
- [6] Profile slot IPM-05, system 5

- [8] Blanking plate
- [9] Air supply plate, port 1:
G1/8 for VTUS 20,
G1/4 for VTUS 25,
G3/8 for VTUS 30
- [10] 3/2-way valve
- [11] 5/2-way bistable valve or 5/3-
way valve or 2x 3/2-way valve

Note
Mounting bracket can be adjusted
through $\pm 30^\circ$

Data sheet – Valve manifold assembly

Type	B2	B3	B4	B12	B13	B17	B18	B19	H1	H2	H3
VTUS-20	107.4	77	23	33.7	33.7	55	40	20	80.4	59	40
VTUS-25	126	92	28.7	33	33	75	60	35	102.5	78	52
VTUS-30	149	109.2	34	42	42	85	65	35	122	95	65

Type	H10	H12	D1 ø	D2	D3 ø	L3	L4	L5	L7	W1
VTUS-20	11.5	2	4.5	M4x6.5	5.2	9	21	22	22	31.3°
VTUS-25	18	2	4.5	M4x9	6.6	8	29.8	27.5	24	30°
VTUS-30	17.5	2.5	5.5	M5x11	8.6	9	34	32	26	28°

Valve positions		2	3	4	5	6	7	8	9	10
VTUS-20	L1 [mm]	64	86	108	130	152	174	196	218	240
	L2 [mm]	90	112	134	156	178	200	222	244	266
VTUS-25	L1 [mm]	87	114.5	142	169.5	197	224.5	252	279.5	307
	L2 [mm]	119	156.5	174	201.5	229	256.5	284	311.5	339
VTUS-30	L1 [mm]	100	132	164	196	228	260	292	324	356
	L2 [mm]	134	166	198	230	262	294	326	358	390

Type codes – Pneumatic valves

001	Series	
VUWS	Pneumatic valve	
002	Directional control valve type	
L	In-line valve	
003	Design principle	
	Piston spool	
T	Poppet valve	
004	Size	
20	Size 20	
25	Size 25	
30	Size 30	
005	Valve function	
M32U	3/2-way valve, normally open	
M32C	3/2-way valve, normally closed	
T32U	2x3/2-way valve, normally open	
T32C	2x3/2-way valve, normally closed	
T32H	2x3/2-way valve, 1x normally closed, 1x normally open	
M52	5/2-way valve, monostable	
B52	5/2-way valve, bistable	
P53U	5/3-way valve, mid-position pressurised	
P53E	5/3-way valve, mid-position exhausted	
P53C	5/3-way valve, mid-position closed	

006	Reset method for monostable valves	
	None	
A	Pneumatic spring	
E	Pneumatic spring, external	
M	Mechanical spring	
007	Pneumatic connection	
G18	G1/8	
G14	G1/4	
G38	G3/8	
G12	G1/2	
N18	1/8 NPT	
N14	1/4 NPT	
N38	3/8 NPT	
Q4	Push-in connector 4 mm	
Q6	Push-in connector 6 mm	
Q8	Push-in connector 8 mm	
Q10	Push-in connector 10 mm	
Q12	Push-in connector 12 mm	
T532	Push-in connector 5/32"	
T14	Push-in connector 1/4"	
T38	Push-in connector 3/8"	
T516	Push-in connector 5/16"	
T12	Push-in connector 1/2"	
008	Exhaust	
	No fitting	
QN	With fitting	
U	Silencer	

Data sheet

-  - Flow rate
up to 600 l/min

-  - Valve width
21 mm

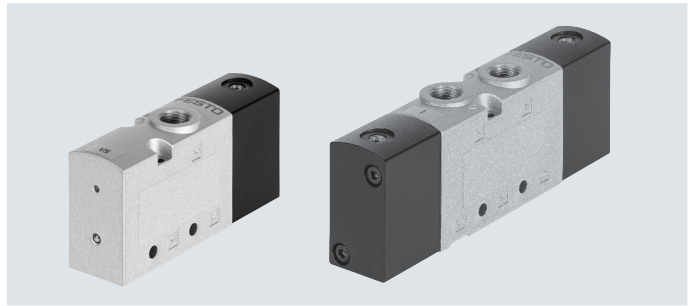

General technical data								
Valve function	3/2-way valve			2x 3/2-way valve			5/2-way valve	
Order code for valves	M32C	M32U	T32C	T32U	T32H	M52	B52	
Valve width [mm]	21							
Design	Poppet seat							
Pneumatic spring supply	Internal							
Type of control	Direct							
Manual override (MO)	None							
Flow direction	Non-reversible							
Overlap	Negative overlap							
Sealing principle	Soft							
Type of mounting	Optionally via through-holes or on manifold rail							
Standard nominal flow rate qnN [l/min]	600	600	600	600	600	500	500	
Through-holes (nominal width) [mm]	5.2	5.2	5.2	5.2	5.2	5	5	
Product weight [g]	117	119	189	191	190	173	192	
Actuation type	Pneumatic							
Mounting position	Any							
Exhaust air function	Can be throttled							
Venting hole	Not ducted							
Pneumatic connection	1, 2, 3	1/8 NPT	1/8 NPT	1/8 NPT	1/8 NPT	1/8 NPT	1/8 NPT	1/8 NPT
	4, 5	-	-	1/8 NPT	1/8 NPT	1/8 NPT	1/8 NPT	1/8 NPT
Pneumatic spring connection 12/14, 10	10-32 UNF-2B							

Technical data – 3/2-way valves						
Order code for valves	M32C	M32U	T32C	T32U	T32H	
Normal position	Closed	Open	Closed	Open	1x open, 1x closed	
Stable position	Monostable					
Reset method	Mechanical spring					
Switching times in [ms]	On	6	6	6	6	6
	Off	19	18	19	18	19

Data sheet

Technical data – 5/2-way valves		
Order code for valves	M52	B52
Stable position	Monostable	Bistable
Reset method	Mechanical spring	–
Switching times in [ms]	On	10
	Off	14
	Change-over	–
		4

Safety characteristics	
Shock resistance	Shock test with severity level 2 to FN 942017-5 and EN 60068-2-27
Vibration resistance	Transport application test with severity level 2 to FN 942017-4 and EN 60068-2-6

Operating and environmental conditions					
Order code for valves		M32	T32	M52	B52
Operating medium		Compressed air to ISO 8573-1:2010 [7:4:4]			
Pilot medium		Compressed air to ISO 8573-1:2010 [7:4:4]			
Note on the operating/pilot medium		Lubricated operation possible (in which case lubricated operation will always be required)			
Operating pressure	[MPa]	–0.09 ... 1	–0.09 ... 1	0.25 ... 1	0.15 ... 1
	[bar]	–0.9 ... 10	–0.9 ... 10	2.5 ... 10	1.5 ... 10
Pilot pressure	[MPa]	0.15 ... 1	0.15 ... 1	0.25 ... 1	0.15 ... 1
	[bar]	1.5 ... 10	1.5 ... 10	2.5 ... 10	1.5 ... 10
Ambient temperature	[°C]	–5 ... +60	–5 ... +60	–10 ... +60	–10 ... +60
Temperature of medium	[°C]	–5 ... +60	–5 ... +60	–10 ... +60	–10 ... +60
Certification		c UL us - Recognized (OL)			
Corrosion resistance class CRC ¹⁾		2			

1) More information: www.festo.com/x/topic/kbk

Information on materials	
Housing	Die-cast aluminium (painted)
Seals	HNBR, NBR, TPE-U(PU)
Screws	Galvanised steel
Note on materials	RoHS-compliant

Data sheet

Dimensions

Download CAD data → www.festo.com

3/2-way valve, normally closed/open

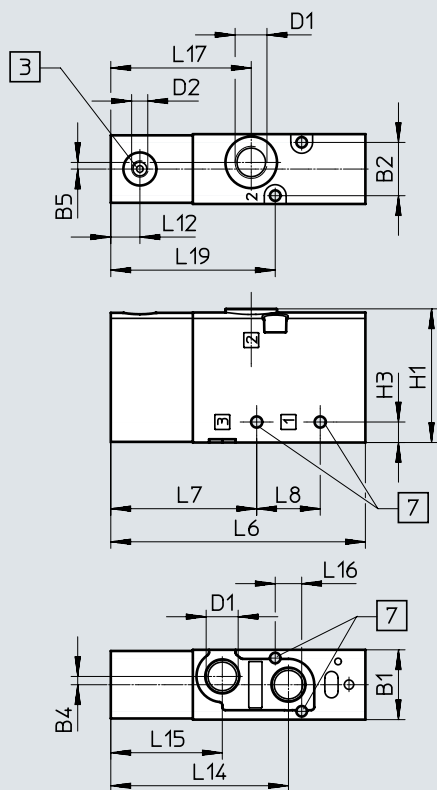

- [3] Port 10 for pilot air (VUWS-LT20-M32U)
Port 12 for pilot air (VUWS-LT20-M32C)
- [7] For retaining screw M3

Type	B1	B2	B4	B5	D1	D2	H1	H3
VUWS-LT20-M32-...-N18	21.1	16.1	2.5	2	1/8 NPT	10-32 UNF-2B	40.4	6.2

Type	L6	L7	L8	L12	L14	L15	L16	L17	L19
VUWS-LT20-M32-...-N18	66.6	44.1	19.2	8.8	53.7	33.7	8	42.5	49.7

Data sheet

Dimensions

5/2-way monostable valve

Download CAD data → www.festo.com

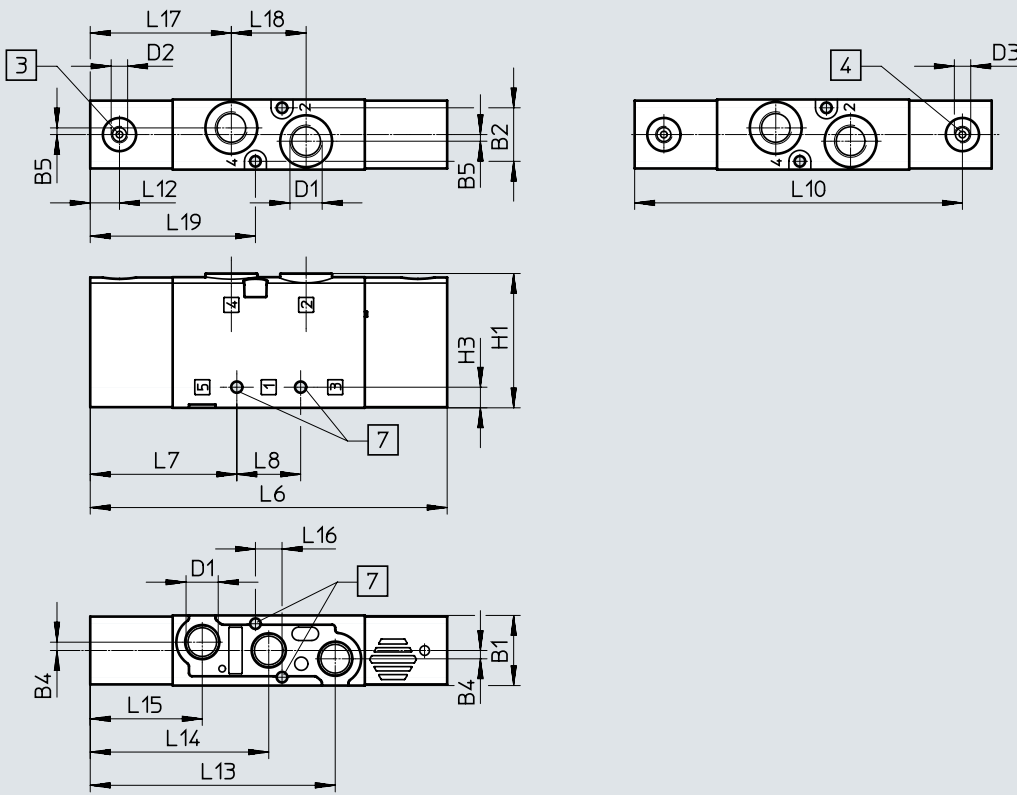

- [3] Port 14: pilot air
- [4] Port 12: pilot air
- [7] For retaining screw M3

Type	B1	B2	B4	B5	D1	D2	D3	H1	H3
VUWS-LT20-M52-M...-N18	21.1	16.1	2.5	2	1/8 NPT	10-32 UNF-2B	-	40.4	6.2

Type	L6	L7	L8	L12	L13	L14	L15	L16	L17	L18	L19
VUWS-LT20-M52-M...-N18	107.4	44.1	19.2	8.8	73.7	53.7	33.7	8	42.5	22.5	49.7

Data sheet

Dimensions

Download CAD data → www.festo.com

2x 3/2-way valve and 5/2-way valve, bistable

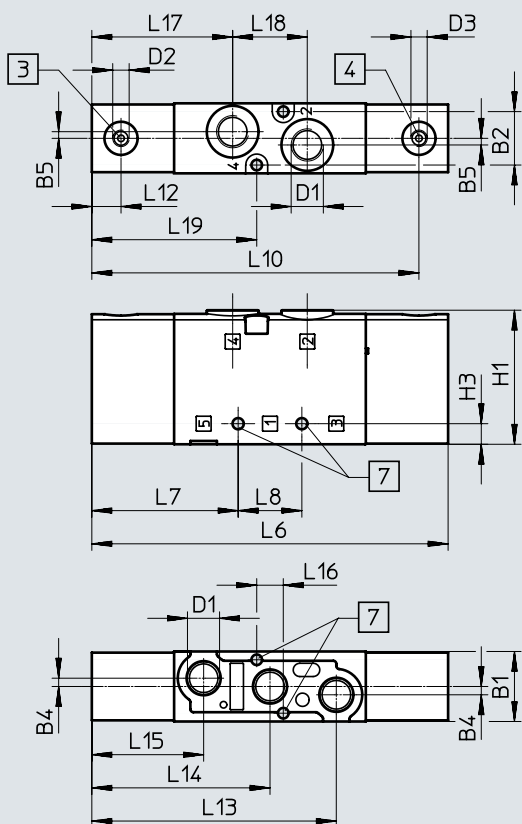

- [3] Port 14: pilot air
- [4] Port 12: pilot air
- [7] For retaining screw M3

Type	B1	B2	B4	B5	D1	D2	D3	H1	H3
VUWS-LT20-T32-...-M-N18	21.1	16.1	2.5	2	1/8 NPT	10-32 UNF-2B	10-32 UNF-2B	40.4	6.2
VUWS-LT20-B52-N18									

Type	L6	L7	L8	L10	L12	L13	L14	L15	L16	L17	L18	L19
VUWS-L20-T32-...-M-N18	107.4	44.1	19.2	98.6	8.8	73.7	53.7	33.7	8	42.5	22.5	49.7
VUWS-LT20-B52-N18												

Data sheet

Dimensions

Foot mounting

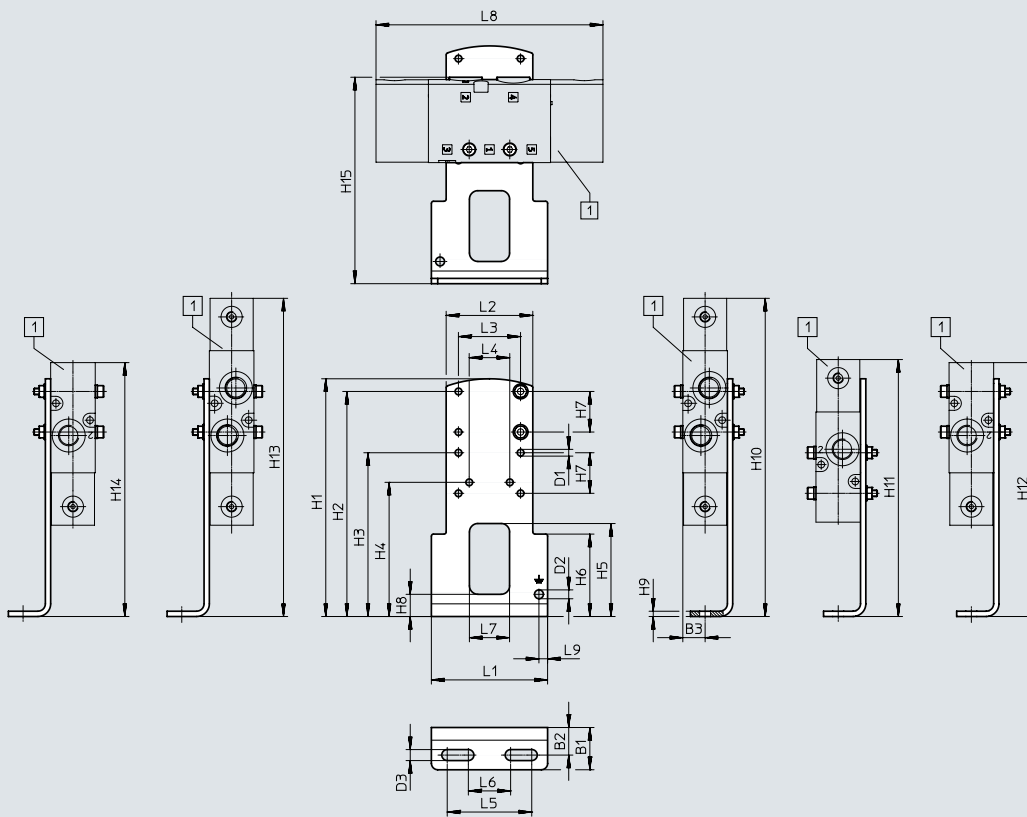

[1] VUWS-L20-B52/T32,
VUWS-L20-M52,
VUWS-L20-M32

Type		B1	B2	B3	D1 ∅	D2 ∅	D3 ∅	H1	H2	H3	H4
VAME-B10-20-A	VUWS-LT20-B52/T32	20	13.1	10.6	3.2	4.2	5.2	112.5	106.5	77.5	63.5
	VUWS-LT20-M52										
	VUWS-LT20-M32										

Type		H5	H6	H7	H8	H9	H10	H11	H12	H13	H14
VAME-B10-20-A	VUWS-LT20-B52/T32	44	39	19.2	10.5	2.5	150.6	121.6	150.6	150.6	150.6
	VUWS-LT20-M52								109.8		
	VUWS-LT20-M32								109.8		

Type		H15	L1	L2	L3	L4	L5	L6	L7	L8	L9
VAME-B10-20-A	VUWS-LT20-B52/T32	97.7	55	41	29.4	19.2	40	20	19	107.4	4.1
	VUWS-LT20-M52									77	
	VUWS-LT20-M32										

Data sheet

Dimensions

Wall mounting

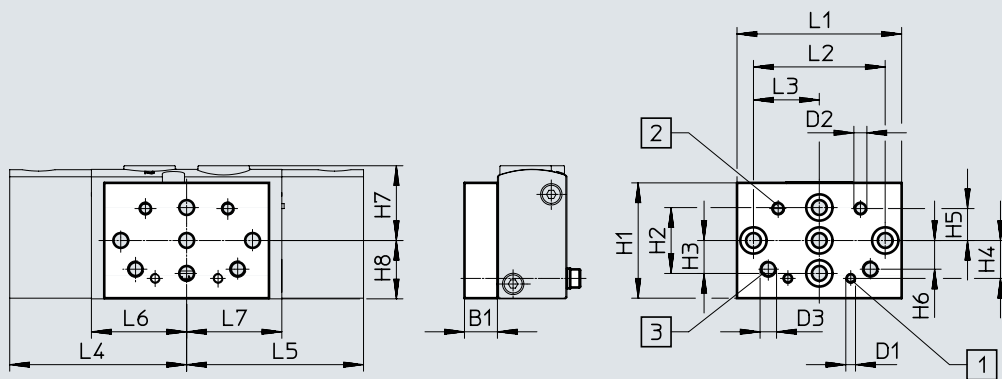

[1] Mounting hole for size 20

[2] Mounting hole for size 25

[3] Mounting hole for size 30



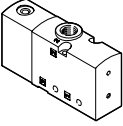
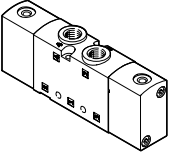
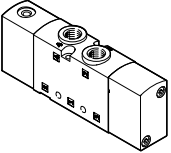

Type		B1	D1	D2	D3	H1	H2	H3	H4	H5	H6
VAME-B10-20-W	VUWS-LT20-B52/T32	10	M3	M4	M5	35	20	10	11.5	9.7	8.7
	VUWS-LT20-M52										
	VUWS-LT20-M32										

Type		H7	H8	L1	L2	L3	L4	L5	L6	L7
VAME-B10-20-W	VUWS-LT20-B52/T32	22.7	17.7	50	40	20	53.7	53.7	28.9	28.9
	VUWS-LT20-M52									
	VUWS-LT20-M32									

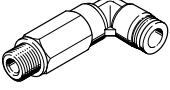
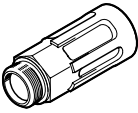

Ordering data

Ordering data				
	Code	Valve function	Part no.	Type
3/2-way valve				
	Normally closed, monostable			
	M32C	Reset via mechanical spring, internal pilot air supply, flow direction not reversible	577532	VUWS-LT20-M32C-M-N18
	Normally open, monostable			
	M32U	Reset via pneumatic spring, internal pilot air supply, flow direction not reversible	577533	VUWS-LT20-M32U-M-N18
2x 3/2-way valve				
	Monostable, normally closed			
	T32C	Reset via mechanical spring, internal pilot air supply, flow direction not reversible	577536	VUWS-LT20-T32C-M-N18
	Monostable, normally open			
	T32U	Reset via mechanical spring, internal pilot air supply, flow direction not reversible	577537	VUWS-LT20-T32U-M-N18
Monostable, 1x normally open, 1x normally closed				
T32H	Reset via mechanical spring, internal pilot air supply, flow direction not reversible	577538	VUWS-LT20-T32H-M-N18	
5/2-way valve				
	Monostable			
	M52-M	Reset via mechanical spring, internal pilot air supply, flow direction not reversible	577534	VUWS-LT20-M52-M-N18
	Bistable			
B52	Internal pilot air supply, flow direction not reversible	577535	VUWS-LT20-B52-N18	

Accessories

Ordering data	Description	Part no.	Type	PU ¹⁾	
Push-in fitting with internal hex					
	Connecting thread 10-32 UNF for tubing O.D.	5/32 "	572312	QBM-10-32-UNF-5/32-I-U	10
	Connecting thread 1/8 NPT for tubing O.D.	5/32 "	572317	QB-1/8-5/32-I-U	10
		1/4 "	572318	QB-1/8-1/4-I-U	10
		5/16 "	572319	QB-1/8-5/16-I-U	10
Angled push-in fitting with external hex					
	Connecting thread 1/8 NPT for tubing O.D.	5/32 "	533290	QBL-1/8-5/32-U	10
		1/4 "	533292	QBL-1/8-1/4-U	10
		5/16 "	533293	QBL-1/8-5/16-U	10
Angled push-in fitting, long, with external hex					
	Connecting thread 1/8 NPT for tubing O.D.	5/32 "	564668	QBL-1/8-5/32-U	10
		1/4 "	564670	QBL-1/8-1/4-U	10
		5/16 "	564671	QBL-1/8-5/16-U	10
Silencer					
	With connecting thread NPT, metal design	1/8 NPT	12638	U-1/8-B-NPT	1
	With connecting thread NPT, sintered design, long	1/8 NPT	1206989	AMTE-M-LH-N18	20

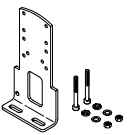
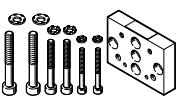
1) Packaging unit

Ordering data	Description	Weight [g]	Part no.	Type
Foot mounting				
	Set for mounting valves, comprising: <ul style="list-style-type: none"> • Mounting bracket and • Screw set for mounting 	97	576412	VAME-B10-20-A
Wall mounting				
	Set for mounting valves for size 20, 25, 30, comprising: <ul style="list-style-type: none"> • Wall mounting and • Screw set for mounting 	53	576413	VAME-B10-20-W
Assortment of spare parts				
	Set comprising: <ul style="list-style-type: none"> • Seals and • Screws 	10	8026203	VAME-B10-20-MK
Inscription label				
	40 pieces in frame	–	565306	ASLR-C-E4

Data sheet

-  - Flow rate
up to 1000 l/min

-  - Valve width
26.5 mm

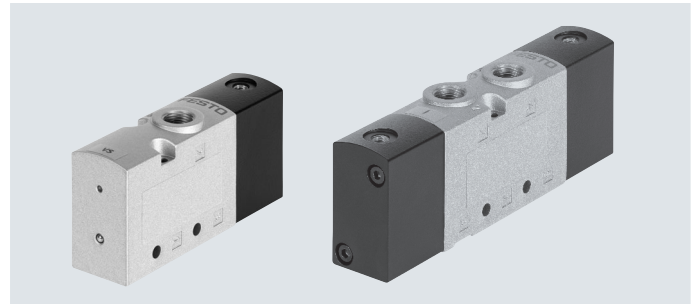
**General technical data**

Valve function	3/2-way valve			2x 3/2-way valve			5/2-way valve	
Order code for valves	M32C	M32U	T32C	T32U	T32H	M52	B52	
Valve width [mm]	26.5							
Design	Poppet seat							
Pneumatic spring supply	Internal							
Type of control	Direct							
Manual override (MO)	None							
Flow direction	Non-reversible							
Overlap	Negative overlap							
Sealing principle	Soft							
Type of mounting	Optionally via through-holes or on manifold rail							
Standard nominal flow rate qnN [l/min]	1000							
Through-holes (nominal width) [mm]	6.9	6.6	6.9	6.9	6.9	6.6	6.6	
Product weight [g]	221	255	343	411	377	317	344	
Actuation type	Pneumatic							
Mounting position	Any							
Exhaust air function	Can be throttled							
Pilot air supply	Internal							
Port for venting hole	Not ducted							
Pneumatic connection	1, 2, 3	1/4 NPT	1/4 NPT	1/4 NPT	1/4 NPT	1/4 NPT	1/4 NPT	1/4 NPT
	4, 5	-	-	1/4 NPT	1/4 NPT	1/4 NPT	1/4 NPT	1/4 NPT
Pneumatic spring connection 12/14, 10	10-32 UNF-2B							

Technical data – 3/2-way valves

Order code for valves	M32C	M32U	T32C	T32U	T32H
Normal position	Closed	Open	Closed	Open	1x open, 1x closed
Stable position	Monostable				
Reset method	Mechanical spring				
Switching times in [ms]	On	6	7	6	7
	Off	29	30	29	30

Data sheet

Technical data – 5/2-way valves		
Order code for valves	M52	B52
Stable position	Monostable	Bistable
Reset method	Mechanical spring	–
Switching times in [ms]	On	8
	Off	23
	Change-over	–
		6

Safety characteristics	
Shock resistance	Shock test with severity level 2 to FN 942017-5 and EN 60068-2-27
Vibration resistance	Transport application test with severity level 2 to FN 942017-4 and EN 60068-2-6

Operating and environmental conditions					
Order code for valves		M32	T32	M52	B52
Operating medium		Compressed air to ISO 8573-1:2010 [7:4:4]			
Pilot medium		Compressed air to ISO 8573-1:2010 [7:4:4]			
Note on the operating/pilot medium		Lubricated operation possible (in which case lubricated operation will always be required)			
Operating pressure	[MPa]	–0.09 ... 1	–0.09 ... 1	0.25 ... 1	0.15 ... 1
	[bar]	–0.9 ... 10	–0.9 ... 10	2.5 ... 10	1.5 ... 10
Pilot pressure	[MPa]	0.25 ... 1	0.25 ... 1	0.25 ... 1	0.15 ... 1
	[bar]	2.5 ... 10	2.5 ... 10	2.5 ... 10	1.5 ... 10
Ambient temperature	[°C]	–5 ... +60	–5 ... +60	–10 ... +60	–10 ... +60
Temperature of medium	[°C]	–5 ... +60	–5 ... +60	–10 ... +60	–10 ... +60
Certification		c UL us - Recognized (OL)			
Corrosion resistance class CRC ¹⁾		2			

1) More information: www.festo.com/x/topic/kbk

Information on materials	
Housing	Die-cast aluminium (painted)
Seals	HNBR, NBR, TPE-U(PU)
Screws	Galvanised steel
Note on materials	RoHS-compliant

Data sheet

Dimensions

Download CAD data → www.festo.com

3/2-way valve, normally closed/open

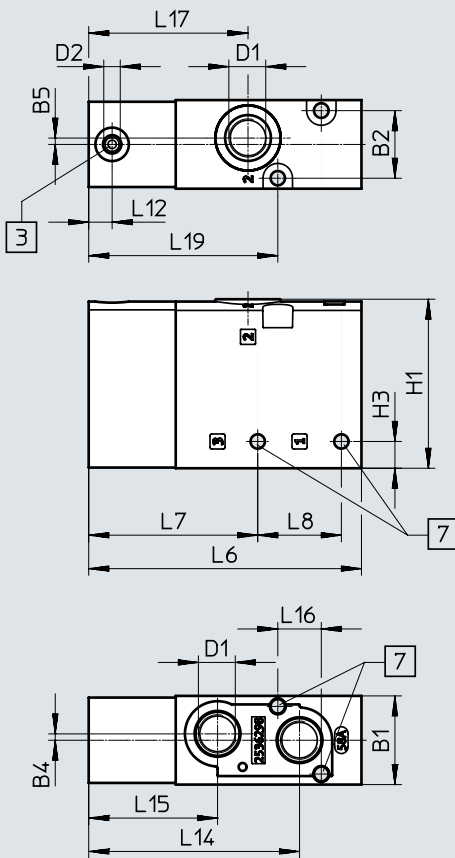

[3] Port 10/12: pilot air

[7] For retaining screw M4

Type	B1	B2	B4	B5	D1	D2	H1	H3
VUWS-LT25-M32...-M-N14	26.5	20.2	1.9	1.9	1/4 NPT	10-32 UNF-2B	50.5	8

Type	L6	L7	L8	L12	L14	L15	L16	L17	L19
VUWS-LT25-M32...-M-N14	81.6	50.5	25	7	63	38.5	13	47.6	56.5

Data sheet

Dimensions

Download CAD data → www.festo.com

5/2-way monostable valve

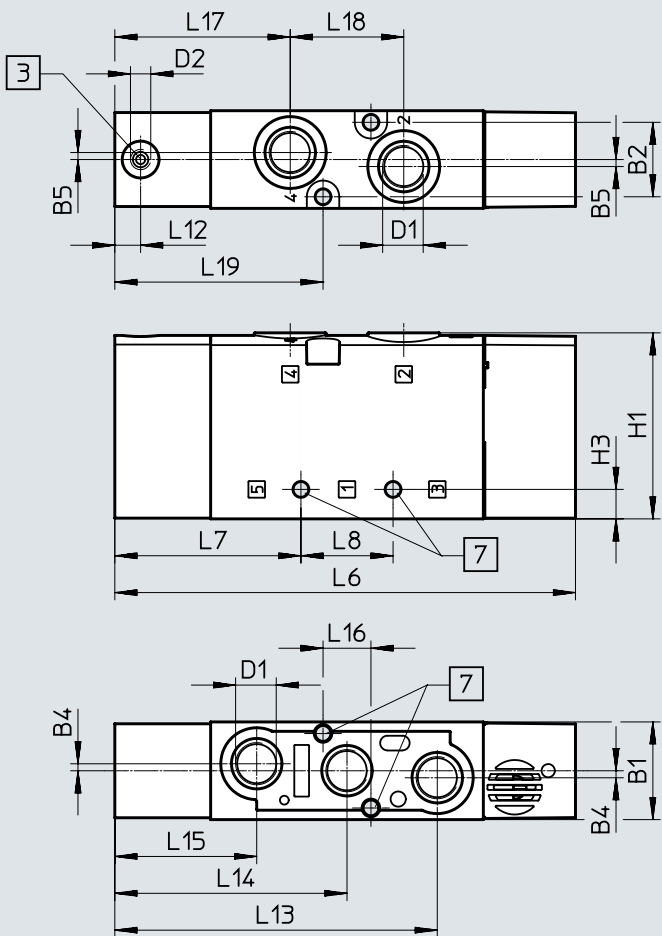

[3] Port 14: pilot air

[7] For retaining screw M4

Type	B1	B2	B4	B5	D1	H1	H3
VUWS-LT25-M52-M-N14	26.5	20.2	1.9	1.9	1/4 NPT	50.5	8

Type	L6	L7	L8	L12	L13	L14	L15	L16	L17	L18	L19
VUWS-LT25-M52-M-N14	125	50.5	25	7	87.5	63	38.5	13	47.6	30.8	56.5

Data sheet

Dimensions

Download CAD data → www.festo.com

2x 3/2-way valve and 5/2-way valve, bistable

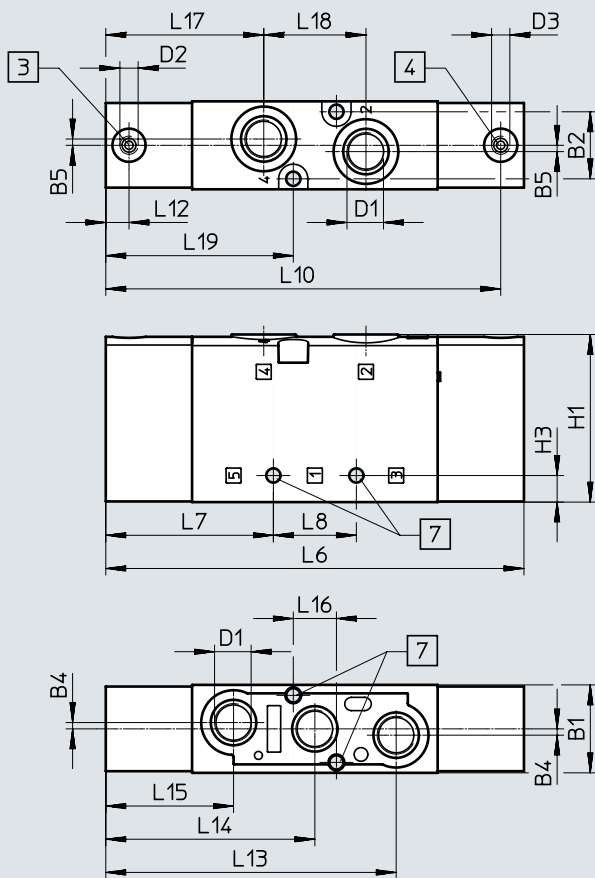

- [3] Port 14: pilot air
- [4] Port 12: pilot air
- [7] For retaining screw M4

Type	B1	B2	B4	B5	D1	D2	D3	H1	H3
VUWS-LT25-B52-N14	26.5	20.2	1.9	1.9	1/4 NPT	10-32 UNF-2B	10-32 UNF-2B	50.5	8
VUWS-LT25-T32...-M-N14									

Type	L6	L7	L8	L10	L12	L13	L14	L15	L16	L17	L18	L19
VUWS-LT25-B52-N14	126	50.5	25	119	7	87.5	63	38.5	13	47.6	30.8	56.5
VUWS-LT25-T32...-M-N14												

Data sheet

Dimensions

Download CAD data → www.festo.com

Foot mounting

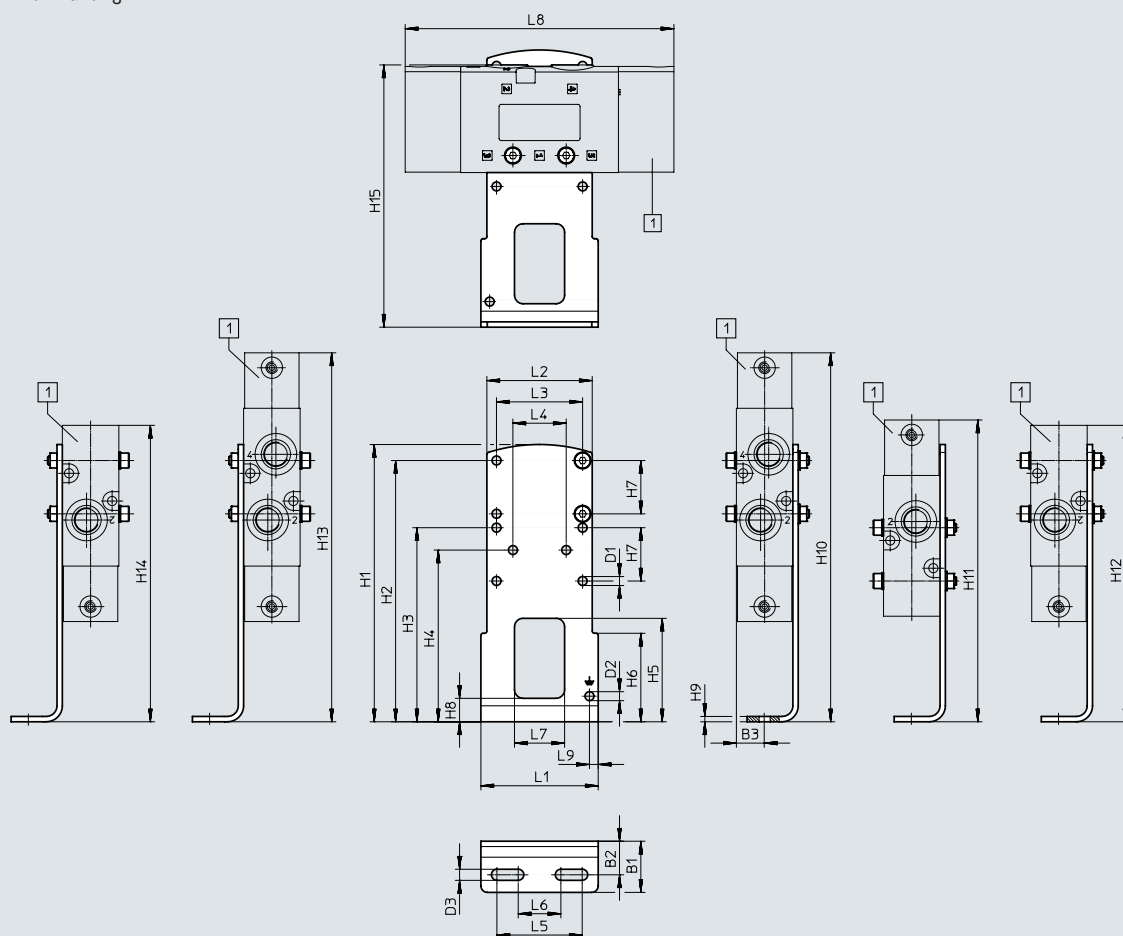

[1] VUWS-LT25-B52/T32,
VUWS-LT25-M52,
VUWS-LT25-M32

Type		B1	B2	B3	D1 ∅	D2 ∅	D3	H1	H2	H3	H4
VAME-B10-25-A	VUWS-LT25-B52/T32	24	15.8	13.3	4.2	4.2	5.2	130	122.5	91	80.5
	VUWS-LT25-M52										
	VUWS-LT25-M32										

Type		H5	H6	H7	H8	H9	H10	H11	H12	H13	H14
VAME-B10-25-A	VUWS-LT25-B52/T32	48.5	41.5	25	11	2.5	173	141.5	173	173	173
	VUWS-LT25-M52								172		172
	VUWS-LT25-M32								128.5		128.5

Type		H15	L1	L2	L3	L4	L5	L6	L7	L8	L9
VAME-B10-25-A	VUWS-LT25-B52/T32	123	55	49.4	40.4	25	40	20	23.5	126	4.1
	VUWS-LT25-M52									125	
	VUWS-LT25-M32									81.5	

Data sheet

Dimensions

Download CAD data → www.festo.com

Wall mounting

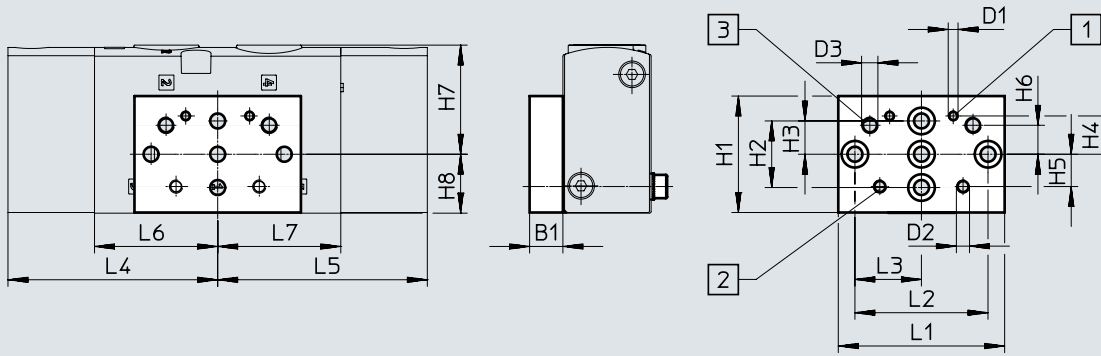

[1] Mounting hole for size 20

[2] Mounting hole for size 25

[3] Mounting hole for size 30



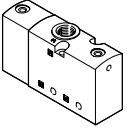
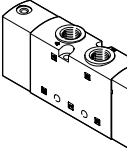
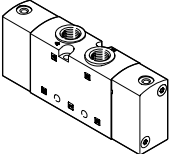
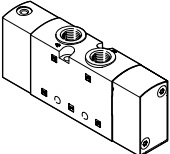
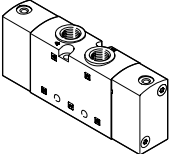

Type		B1	D1	D2	D3	H1	H2	H3	H4	H5	H6
VAME-B10-20-W	VUWS-LT25-B52/T32	10	M3	M4	M5	35	20	10	11.5	9.7	8.7
	VUWS-LT25-M52										
	VUWS-LT25-M32										

Type		H7	H8	L1	L2	L3	L4	L5	L6	L7
VAME-B10-20-W	VUWS-LT25-B52/T32	32.8	17.7	50	40	20	63	37	37	37
	VUWS-LT25-M52									
	VUWS-LT25-M32									

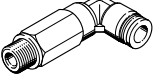
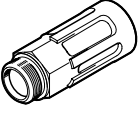

Accessories

Ordering data – Pneumatic valves				
	Code	Valve function	Part no.	Type
3/2-way valve				
	Normally closed, monostable			
	M32C-M	Reset via mechanical spring, internal pilot air supply, flow direction not reversible	8035217	VUWS-LT25-M32C-M-N14
	Normally open, monostable			
	M32U-M	Reset via mechanical spring, internal pilot air supply, flow direction not reversible	8035219	VUWS-LT25-M32U-M-N14
2x 3/2-way valve				
	Normally closed, monostable			
	T32C	Reset via mechanical spring, internal pilot air supply, flow direction not reversible	8035225	VUWS-LT25-T32C-M-N14
	Normally open, monostable			
T32U	Reset via mechanical spring, internal pilot air supply, flow direction not reversible	8035227	VUWS-LT25-T32U-M-N14	
1x normally open, 1x normally closed, monostable				
T32H	Reset via mechanical spring, internal pilot air supply, flow direction not reversible	8035229	VUWS-LT25-T32H-M-N14	
5/2-way valve				
	Monostable			
	M52-M	Reset via mechanical spring, internal pilot air supply, flow direction not reversible	8035221	VUWS-LT25-M52-M-N14
	Bistable			
	B52	Internal pilot air supply, flow direction not reversible	8035223	VUWS-LT25-B52-N14

Accessories

Ordering data		Description	Part no.	Type	PU ¹⁾
Push-in fitting with internal hex					
	Connecting thread 10-32 UNF for tubing O.D.	5/32 "	572312	QBM-10-32-UNF-5/32-I-U	10
	Connecting thread 1/4 NPT for tubing O.D.	1/4 "	572320	QB-1/4-1/4-I-U	10
		5/16 "	572321	QB-1/4-5/16-I-U	10
		3/8 "	572322	QB-1/4-3/8-I-U	10
Angled push-in fitting with external hex					
	Connecting thread 1/4 NPT for tubing O.D.	1/4 "	533295	QBL-1/4-1/4-U	10
		5/16 "	533296	QBL-1/4-5/16-U	10
		3/8 "	533297	QBL-1/4-3/8-U	5
Angled push-in fitting, long, with external hex					
	Connecting thread 1/4 NPT for tubing O.D.	1/4 "	564674	QBL-1/4-1/4-U	10
		5/16 "	564675	QBL-1/4-5/16-U	10
		3/8 "	564676	QBL-1/4-3/8-U	5
Silencer					
	With connecting thread NPT, metal design	1/4 NPT	12639	U-1/4-B-NPT	1
	With connecting thread NPT, sintered design, long	1/4 NPT	1206990	AMTE-M-LH-N14	20

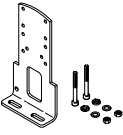
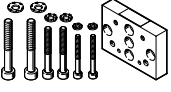
1) Packaging unit

Ordering data		Description	Weight [g]	Part no.	Type
Foot mounting					
	With screw set for attaching the valve to the foot mounting	130	2293485	VAME-B10-25-A	
Wall mounting					
	With screw set for attaching the valve to the wall mounting	53	576413	VAME-B10-20-W	
Assortment of spare parts					
	Set comprising seals and screws	12	8035636	VAME-B10-25-MK	
Inscription label					
	40 pieces in frame	-	565306	ASLR-C-E4	

Data sheet

-  - Flow rate
up to 1800 l/min

-  - Valve width
31 mm

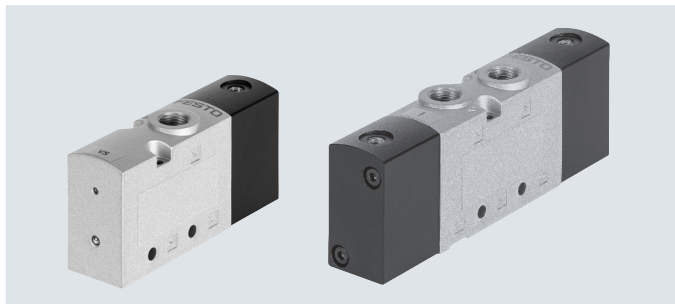

General technical data

Valve function	3/2-way valve		2x 3/2-way valve			5/2-way valve	
Order code for valves	M32C	M32U	T32C	T32U	T32H	M52	B52
Valve width [mm]	31						
Design	Poppet seat						
Pneumatic spring supply	Internal						
Type of control	Direct						
Manual override (MO)	None						
Flow direction	Non-reversible						
Overlap	Negative overlap						
Sealing principle	Soft						
Type of mounting	Optionally via through-holes or on manifold rail						
Standard nominal flow rate qnN [l/min]	1600	1600	1600	1600	1600	1800	1800
Through-holes (nominal width) [mm]	7.9	7.9	7.9	7.8	7.8	8.1	8.7
Product weight [g]	345	352	515	533	524	473	521
Actuation type	Pneumatic						
Mounting position	Any						
Exhaust air function	Can be throttled						
Pilot air supply	Internal						
Port for venting hole	Not ducted						
Pneumatic connection	1, 2, 3	3/8 NPT	3/8 NPT	3/8 NPT	3/8 NPT	3/8 NPT	3/8 NPT
	4, 5	-	-	3/8 NPT	3/8 NPT	3/8 NPT	3/8 NPT
Pneumatic spring connection 12/14, 10	1/8 NPT						

Technical data – 3/2-way valves

Order code for valves	M32C	M32U	T32C	T32U	T32H
Normal position	Closed	Open	Closed	Open	1x open, 1x closed
Stable position	Monostable				
Reset method	Mechanical spring				
Switching times in [ms]	On	11	12	12	12
	Off	37	45	37	45

Data sheet

Technical data – 5/2-way valves		
Order code for valves	M52	B52
Stable position	Monostable	Bistable
Reset method	Mechanical spring	–
Switching times in [ms]	On	17
	Off	77
	Change-over	–
		13

Safety characteristics	
Shock resistance	Shock test with severity level 2 to FN 942017-5 and EN 60068-2-27
Vibration resistance	Transport application test with severity level 2 to FN 942017-4 and EN 60068-2-6

Operating and environmental conditions					
Order code for valves		M32	T32	M52	B52
Operating medium		Compressed air to ISO 8573-1:2010 [7:4:4]			
Pilot medium		Compressed air to ISO 8573-1:2010 [7:4:4]			
Note on the operating/pilot medium		Lubricated operation possible (in which case lubricated operation will always be required)			
Operating pressure	[MPa]	0.1 ... 1	0.1 ... 1	0.25 ... 1	0.15 ... 1
	[bar]	1.0 ... 10	1.0 ... 10	2.5 ... 10	1.5 ... 10
Pilot pressure	[MPa]	0.25 ... 1	0.25 ... 1	0.25 ... 1	0.15 ... 1
	[bar]	2.5 ... 10	2.5 ... 10	2.5 ... 10	1.5 ... 10
Ambient temperature	[°C]	–10 ... +60			
Temperature of medium	[°C]	–10 ... +60			
Certification		c UL us - Recognized (OL)			
Corrosion resistance class CRC ¹⁾		2			

1) More information: www.festo.com/x/topic/kbk

Information on materials				
Order code for valves		M32	T32	B52
Housing		Die-cast aluminium (painted)		
Piston spool		POM		Wrought aluminium alloy
Seals		HNBR, NBR, TPE-U(PU)		
Screws		Galvanised steel		
Note on materials		RoHS-compliant		

Data sheet

Dimensions

Download CAD data → www.festo.com

3/2-way valve, normally closed/open

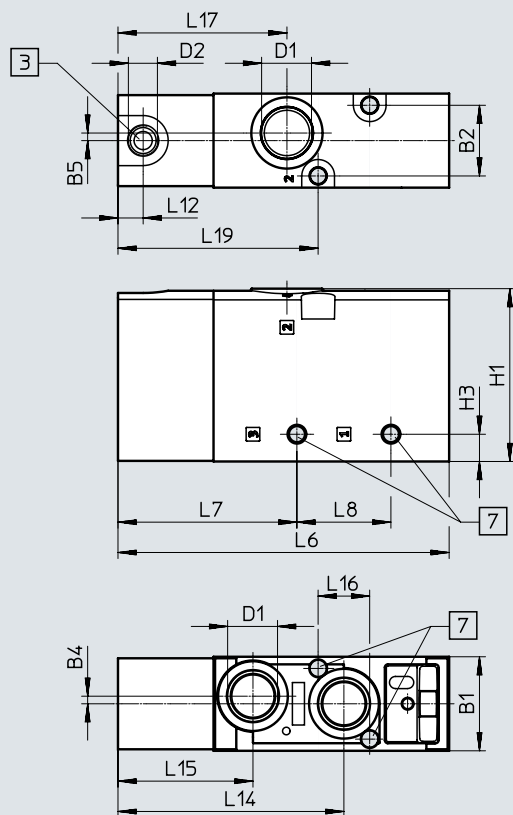

- [3] Port 10: pilot air (...-M32U-...)
Port 12: pilot air (...-M32C-...)
- [7] For retaining screw M5

Type	B1	B2	B4	B5	D1	D2	H1	H3
VUWS-LT30-M32C-...-N38	31	23.3	2.5	2.5	3/8 NPT	1/8 NPT	57	9
VUWS-LT30-M32U-...-N38								

Type	L6	L7	L8	L12	L14	L15	L16	L17	L19
VUWS-LT30-M32C-...-N38	97.5	59	31	8.3	74.5	44.5	17	55.7	66
VUWS-LT30-M32U-...-N38									

Data sheet

Dimensions

Download CAD data → www.festo.com

5/2-way monostable valve

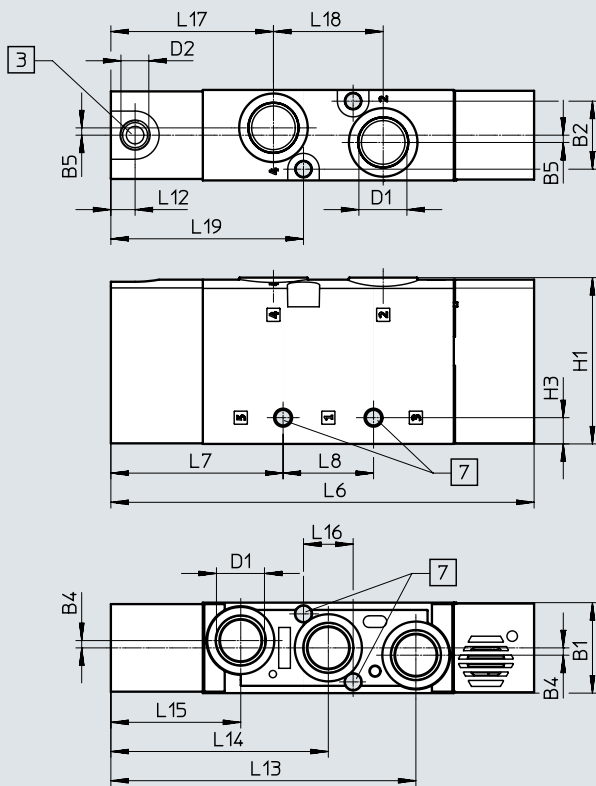

[3] Port 14: pilot air (-M52-...)

[7] For retaining screw M5

Type	B1	B2	B4	B5	D1	D2	H1	H3
VUWS-LT30-M52-...-N38	31	23.3	2.5	2.5	3/8 NPT	1/8 NPT	57	9

Type	L6	L7	L8	L12	L13	L14	L15	L16	L17	L18	L19
VUWS-LT30-M52-...-N38	145	59	31	8.3	104.5	74.5	44.5	17	55.7	37.6	66

Data sheet

Dimensions

Download CAD data → www.festo.com

2x 3/2-way valve and 5/2-way valve, bistable

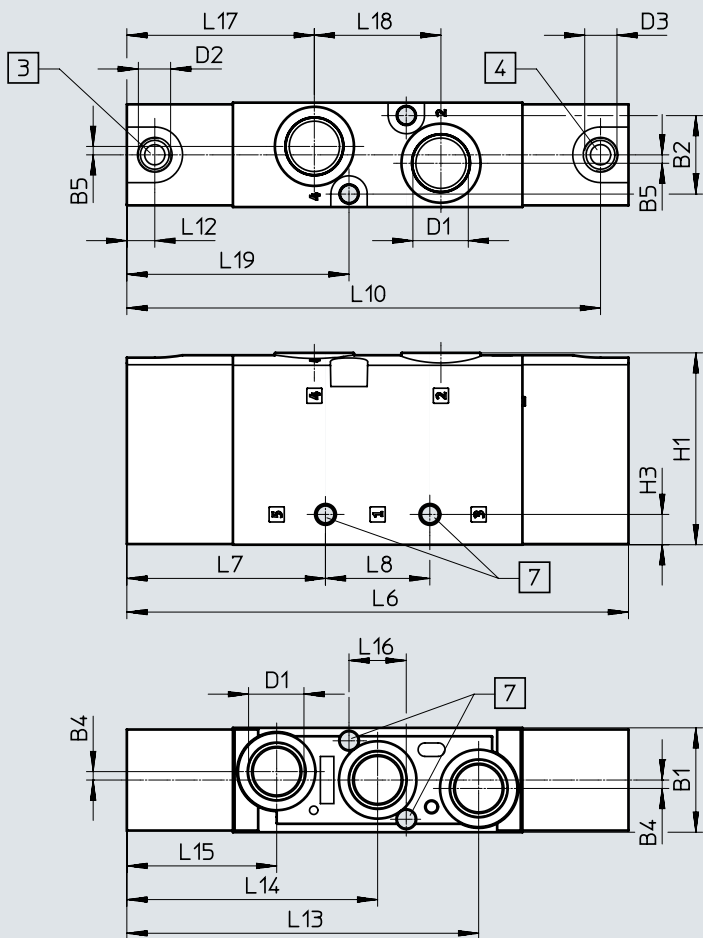

- [3] Port 14: pilot air
- [4] Port 12: pilot air
- [7] For retaining screw M5

Type	B1	B2	B4	B5	D1	D2	D3	H1	H3
VUWS-LT30-T32...-M-N38	31	23.3	2.5	2.5	3/8 NPT	1/8 NPT	1/8 NPT	57	9
VUWS-LT30-B52-N38									

Type	L6	L7	L8	L10	L12	L13	L14	L15	L16	L17	L18	L19
VUWS-LT30-T32...-M-N38	149	59	31	140.7	8.3	104.5	74.5	44.5	17	55.7	37.6	66
VUWS-LT30-B52-N38												

Data sheet

Dimensions

Download CAD data → www.festo.com

Foot mounting

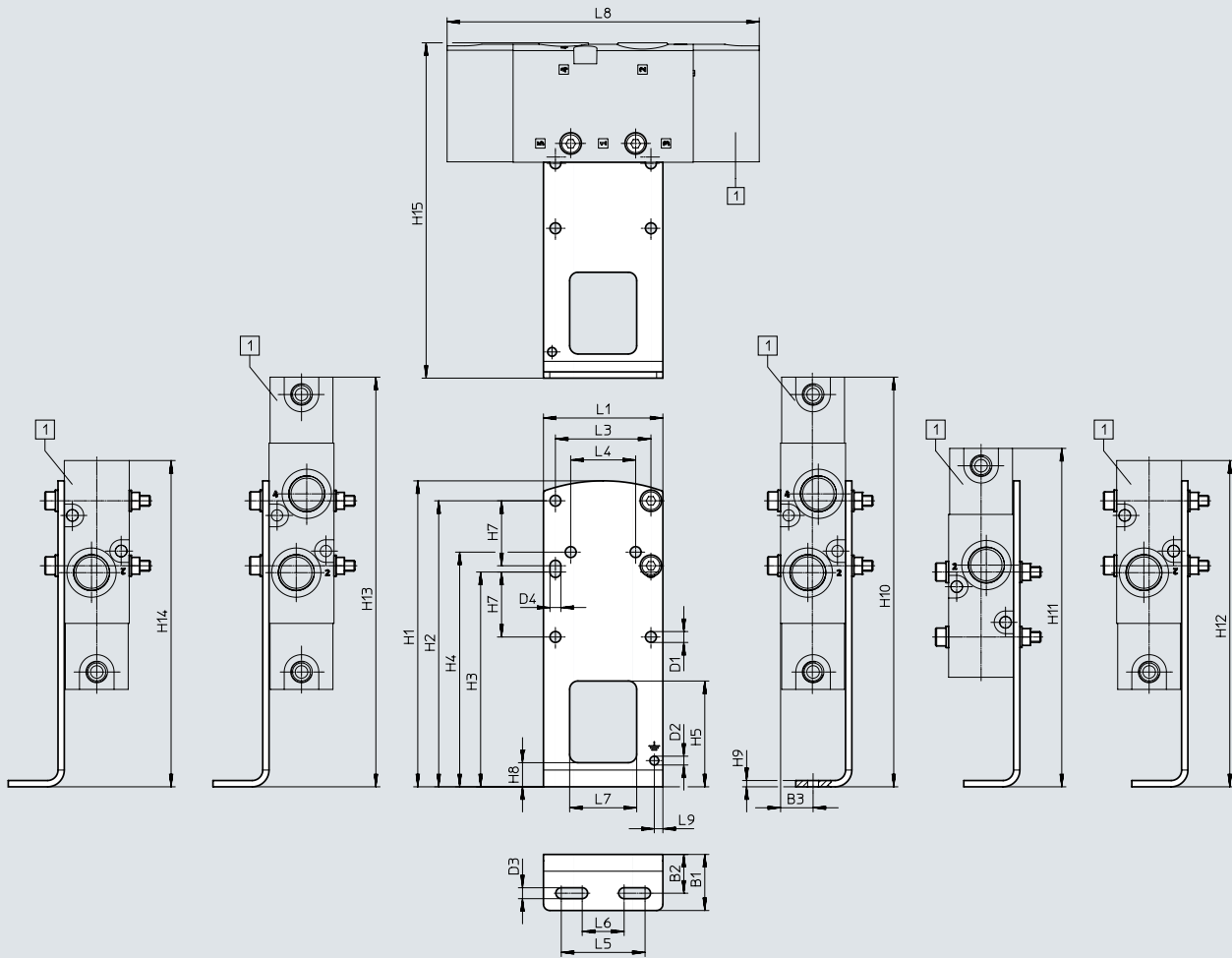

[1] VUWS-LT30-B52/T32,
VUWS-LT30-M52,
VUWS-LT30-M32

Type		B1	B2	B3	D1 ∅	D2 ∅	D3	D4	H1	H2	H3
VAME-B10-30-A	VUWS-LT30-B52/T32	26.8	18.5	15.5	5.2	4.2	5.2	5.2	146	136.5	102.5
	VUWS-LT30-M52										
	VUWS-LT30-M32										

Type		H4	H5	H7	H8	H9	H10	H11	H12	H13	H14
VAME-B10-30-A	VUWS-LT30-B52/T32	112	50.5	31	11.5	3	195.5	161.5	195.5	195.5	195.5
	VUWS-LT30-M52								191.5		191.5
	VUWS-LT30-M32								144		144

Type		H15	L1	L3	L4	L5	L6	L7	L8	L9
VAME-B10-30-A	VUWS-LT30-B52/T32	160	57	45.6	31	40	20	32	149	4.1
	VUWS-LT30-M52								145	
	VUWS-LT30-M32								97.5	

Data sheet

Dimensions

Download CAD data → www.festo.com

Wall mounting

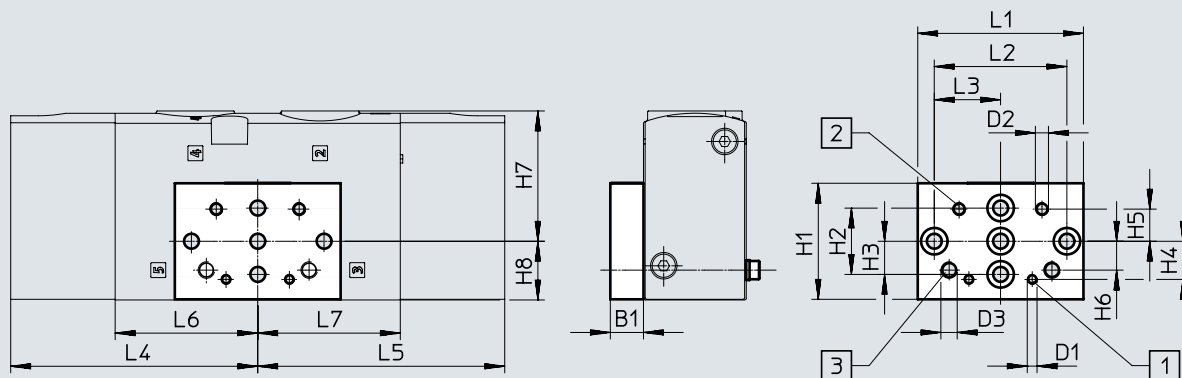

[1] Mounting hole for size 20 [2] Mounting hole for size 25 [3] Mounting hole for size 30



Type		B1	D1	D2	D3	H1	H2	H3	H4	H5	H6
VAME-B10-20-W	VUWS-L30-B52/T32	10	M3	M4	M5	35	20	10	11.5	9.7	8.7
	VUWS-L30-M52										
	VUWS-L30-M32										

Type		H7	H8	L1	L2	L3	L4	L5	L6	L7
VAME-B10-20-W	VUWS-L30-B52/T32	39.3	17.7	50	40	20	74.5	43	74.5	43
	VUWS-L30-M52								70.5	-
	VUWS-L30-M32								34.7	-

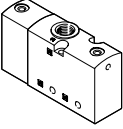
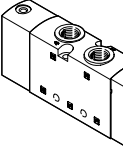
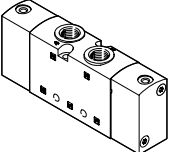
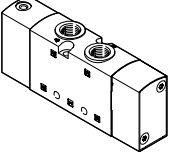
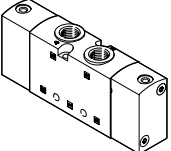

Accessories

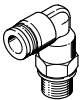
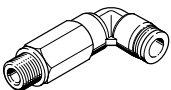
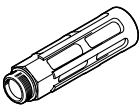
Ordering data – Pneumatic valves				
	Code	Valve function	Part no.	Type
3/2-way valve				
	Normally closed, monostable			
	M32C-M	Reset via mechanical spring, internal pilot air supply, flow direction not reversible	8036722	VUWS-LT30-M32C-M-N38
	Normally open, monostable			
	M32U-M	Reset via mechanical spring, internal pilot air supply, flow direction not reversible	8036724	VUWS-LT30-M32U-M-N38
2x 3/2-way valve				
	Normally closed, monostable			
	T32C	Reset via mechanical spring, internal pilot air supply, flow direction not reversible	8036730	VUWS-LT30-T32C-M-N38
	Normally open, monostable			
T32U	Reset via mechanical spring, internal pilot air supply, flow direction not reversible	8036732	VUWS-LT30-T32U-M-N38	
1x normally open, 1x normally closed, monostable				
T32H	Reset via mechanical spring, internal pilot air supply, flow direction not reversible	8036734	VUWS-LT30-T32H-M-N38	
5/2-way valve				
	Monostable			
	M52-M	Reset via mechanical spring, internal pilot air supply, flow direction not reversible	8036726	VUWS-LT30-M52-M-N38
	Bistable			
	B52	Internal pilot air supply, flow direction not reversible	8036728	VUWS-LT30-B52-N38

Accessories

Ordering data	Description	Part no.	Type	PU ¹⁾	
Push-in fitting with internal hex					
	Connecting thread 1/8 NPT for tubing O.D.	1/4 "	572318	QB-1/8-1/4-I-U	10
	Connecting thread 3/8 NPT for tubing O.D.	5/16 "	572323	QB-3/8-5/16-I-U	10
		3/8 "	572324	QB-3/8-3/8-I-U	10
		1/2 "	572325	QB-3/8-1/2-I-U	10
Angled push-in fitting with external hex					
	Connecting thread 3/8 NPT for tubing O.D.	5/16 "	533299	QBL-3/8-5/16-U	5
		3/8 "	533300	QBL-3/8-3/8-U	5
		1/2 "	533301	QBL-3/8-1/2-U	5
Angled push-in fitting, long, with external hex					
	Connecting thread 3/8 NPT for tubing O.D.	5/16 "	564679	QBL-3/8-5/16-U	5
		3/8 "	564680	QBL-3/8-3/8-U	5
		1/2 "	564681	QBL-3/8-1/2-U	5
Silencer					
	With connecting thread NPT, metal design	3/8 NPT	12740	U-3/8-B-NPT	1
	With connecting thread NPT, sintered design, long	3/8 NPT	1206991	AMTE-M-LH-N38	10

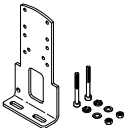
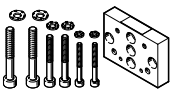
1) Packaging unit

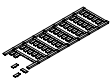
Ordering data	Description	Weight [g]	Part no.	Type
Foot mounting				
	Set for mounting valves, comprising: <ul style="list-style-type: none"> • Mounting bracket and • Screw set for mounting 	–	8026337	VAME-B10-30-A
Wall mounting				
	Set for mounting valves for size 20, 25, 30, comprising: <ul style="list-style-type: none"> • Wall mounting and • Screw set for mounting 	53	576413	VAME-B10-20-W
Assortment of spare parts				
	Set comprising: <ul style="list-style-type: none"> • Seals and • Screws 	–	8035637	VAME-B10-30-MK
Inscription label				
	40 pieces in frame	–	565306	ASLR-C-E4

Data sheet

-  - Flow rate
up to 700 l/min

-  - Valve width
21 mm

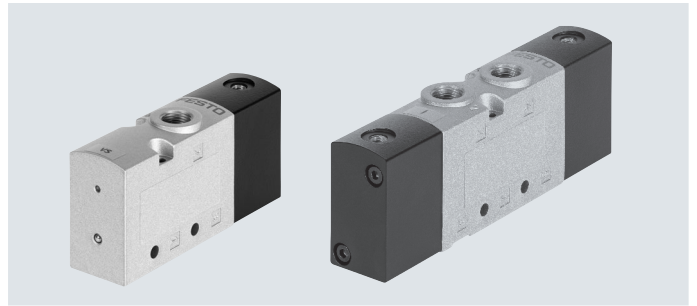

General technical data		3/2		5/2		5/3			
Valve function		3/2		5/2		5/3			
Order code for valves		M32C	M32U	M52	B52	P53C	P53U	P53E	
Valve width	[mm]	21							
Design		Piston spool							
Pneumatic spring supply		Internal							
Type of control		Direct							
Manual override (MO)		None							
Flow direction		Reversible with restrictions							
Overlap		Positive overlap							
Sealing principle		Soft							
Type of mounting		Optionally via through-holes ¹⁾ or on manifold rail							
Standard nominal flow rate qnN	[l/min]	700		700		700	600	600	
Through-holes (nominal width)	[mm]	5.7		5.7		5.0	4.8	4.5	
Product weight	[g]	145		178/190 ²⁾		211	207	207	207
Actuation type		Pneumatic							
Mounting position		Any							
Exhaust air function		Can be throttled							
Venting hole		Not ducted							
Pneumatic connection	1, 2, 3 4, 5	1/8 NPT	1/8 NPT	1/8 NPT	1/8 NPT	1/8 NPT	1/8 NPT	1/8 NPT	
Pneumatic spring connection 12/14, 10		10-32 UNF-2B							

1) If several valves are to be screwed together via through-holes to form a block, a minimum distance of 0.3 mm must be ensured by placing spacer discs between them.
2) With external pneumatic spring: 190 g, with internal pneumatic spring or mechanical spring: 178 g

Technical data – 3/2-way valves		M32C		M32U	
Normal position		Closed		Open	
Stable position		Monostable		Monostable	
Reset method		Pneumatic spring		Mechanical spring (supported internally by pneumatic spring)	
Switching times in [ms]	On	7	10	7	10
	Off	15	28	15	28

Data sheet

Technical data – 5/2-way valves			
Order code for valves		M52	B52
Stable position		Monostable	
Reset method		Pneumatic spring	Mechanical spring
Switching times in [ms]	On	13	7
	Off	26	39
	Change-over	–	–
			6

Technical data – 5/3-way valves				
Order code for valves		P53C	P53U	P53E
Stable position		Monostable		
Reset method		Mechanical spring		
Switching times in [ms]	On	10	10	10
	Off	44	43	46
	Change-over	26	21	21

Safety characteristics	
Shock resistance	Shock test with severity level 2 to FN 942017-5 and EN 60068-2-27
Vibration resistance	Transport application test with severity level 2 to FN 942017-4 and EN 60068-2-6

Operating and environmental conditions						
Valve function		M32 ... A M32 ... M	M52-A	M52-M	B52	P53
Operating medium		Compressed air to ISO 8573-1:2010 [7:4:4]				
Pilot medium		Compressed air to ISO 8573-1:2010 [7:4:4]				
Note on the operating/pilot medium		Lubricated operation possible (in which case lubricated operation will always be required)				
Operating pressure	[MPa]	0.25 ... 1	0.25 ... 1	–0.09 ... +1	–0.09 ... +1	–0.09 ... +1
	[bar]	2.5 ... 10	2.5 ... 10	–0.9 ... +10	–0.9 ... +10	–0.9 ... +10
Pilot pressure	[MPa]	0.25 ... 1	0.25 ... 1	0.25 ... 1	0.15 ... 1	0.25 ... 1
	[bar]	2.5 ... 10	2.5 ... 10	2.5 ... 10	1.5 ... 10	2.5 ... 10
Ambient temperature	[°C]	–10 ... +60				
Temperature of medium	[°C]	–10 ... +60				
Certification		c UL us - Recognized (OL)				
Corrosion resistance class CRC ¹⁾		2				

1) More information: www.festo.com/x/topic/kbk

Information on materials	
Housing	Die-cast aluminium (painted)
Seals	HNBR, NBR
Piston spool	Wrought aluminium alloy (P53 types: High-alloy stainless steel)
Screws	Galvanised steel
Note on materials	RoHS-compliant

Special features of pneumatic 3/2-way valves

Reset via mechanical spring

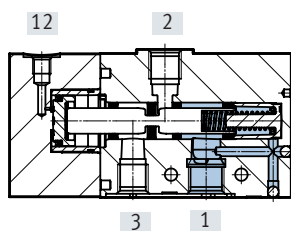

Internal pneumatic spring

- Faster switch-off time
- In the case of dual-pressure operation, the higher pressure must always be present at port 1
- Pressure on port 2 not permitted

Data sheet

Dimensions

Download CAD data → www.festo.com

3/2-way valve, normally closed/open

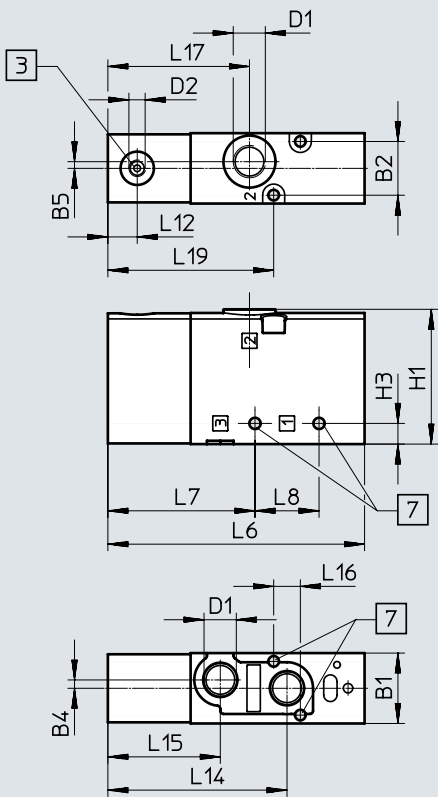

- [3] Port 10: for pilot air (...-M32U-...)
Port 12: for pilot air (...-M32C-...)
- [7] For retaining screw M3

Type	B1	B2	B4	B5	D1	D2	H1	H3
VUWS-L20-M32C-...-N18	21.1	16.1	2.5	2	1/8 NPT	10-32 UNF-2B	40.4	6.2
VUWS-L20-M32U-...-N18								

Type	L6	L7	L8	L10	L12	L14	L15	L16	L17	L19
VUWS-L20-M32C-...-N18	77	44.1	19.2	-	8.8	53.7	33.7	8	42.5	49.7
VUWS-L20-M32U-...-N18										

Data sheet

Dimensions

Download CAD data → www.festo.com

5/2-way monostable valve

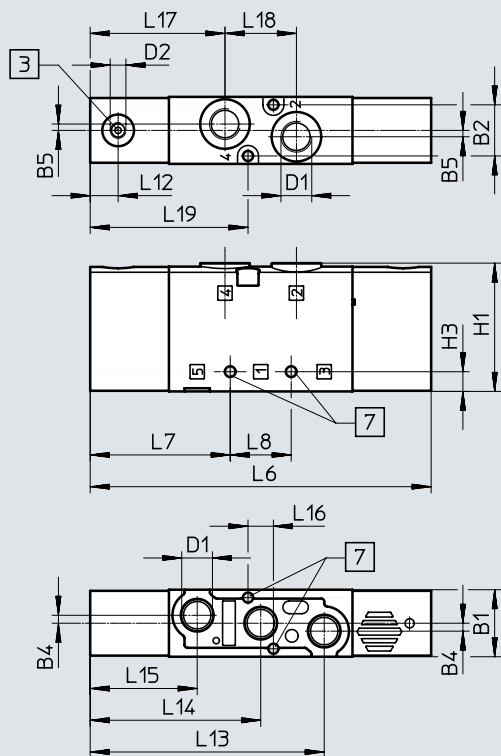

[3] Port 14: for pilot air (-M52-A-...)

[7] For retaining screw M3

Type	B1	B2	B4	B5	D1	D2	H1	H3
VUWS-L20-M52-...-N18	21.1	16.1	2.5	2	1/8 NPT	10-32 UNF-2B	40.4	6.2

Type	L6	L7	L8	L10	L12	L13	L14	L15	L16	L17	L18	L19
VUWS-L20-M52-...-N18	107.4	44.1	19.2	98.6	8.8	73.7	53.7	33.7	8	42.5	22.5	49.7

Data sheet

Dimensions

Download CAD data → www.festo.com

5/2-way valve, bistable, 5/3-way valve

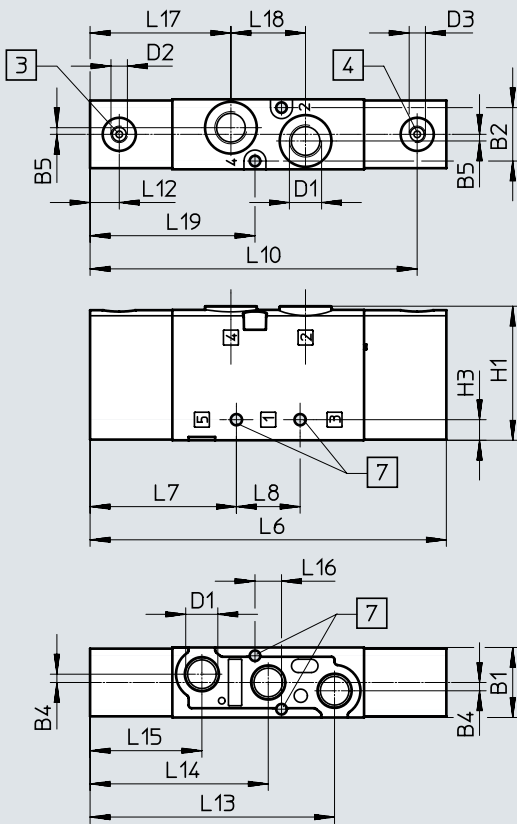

- [3] Port 14: for pilot air
- [4] Port 12: for pilot air
- [7] For retaining screw M3

Type	B1	B2	B4	B5	D1	D2	D3	H1	H3
VUWS-L20-P53...-M-N18	21.1	16.1	2.5	2	1/8 NPT	10-32 UNF-2B	10-32 UNF-2B	40.4	6.2
VUWS-L20-B52-N18									

Type	L6	L7	L8	L10	L12	L13	L14	L15	L16	L17	L18	L19
VUWS-L20-P53...-M-N18	107.4	44.1	19.2	98.6	8.8	73.7	53.7	33.7	8	42.5	22.5	49.7
VUWS-L20-B52-N18												

Data sheet

Dimensions

Foot mounting

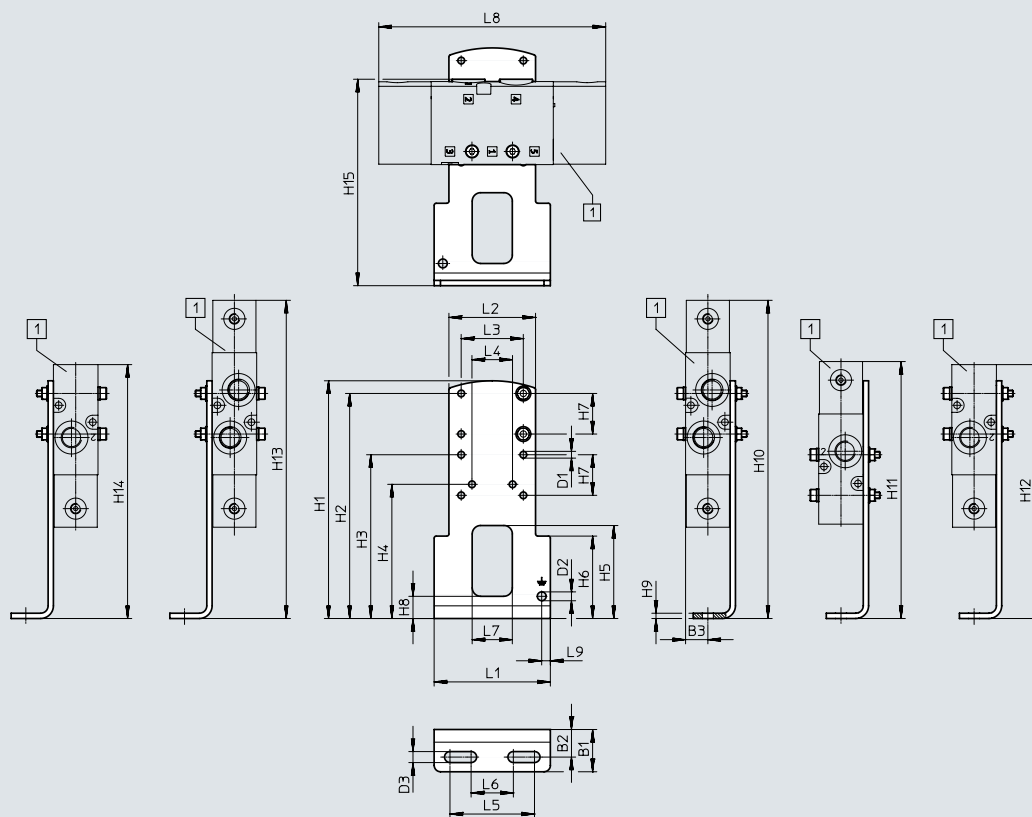

[1] VUWS-L20-B52,
VUWS-L20-P53,
VUWS-L20-M52,
VUWS-L20-M32

Type		B1	B2	B3	D1 ∅	D2 ∅	D3 ∅	H1	H2	H3	H4
VAME-B10-20-A	VUWS-L20-B52/P53	20	13.1	10.6	3.2	4.2	5.2	112.5	106.5	77.5	63.5
	VUWS-L20-M52										
	VUWS-L20-M32										

Type		H5	H6	H7	H8	H9	H10	H11	H12	H13	H14
VAME-B10-20-A	VUWS-L20-B52/P53	44	39	19.2	10.5	2.5	150.6	121.6	150.6	150.6	150.6
	VUWS-L20-M52								120.2		
	VUWS-L20-M32								120.2		

Type		H15	L1	L2	L3	L4	L5	L6	L7	L8	L9
VAME-B10-20-A	VUWS-L20-B52/P53	97.7	55	41	29.4	19.2	40	20	19	107.4	4.1
	VUWS-L20-M52									77	
	VUWS-L20-M32									77	

Data sheet

Dimensions

Wall mounting

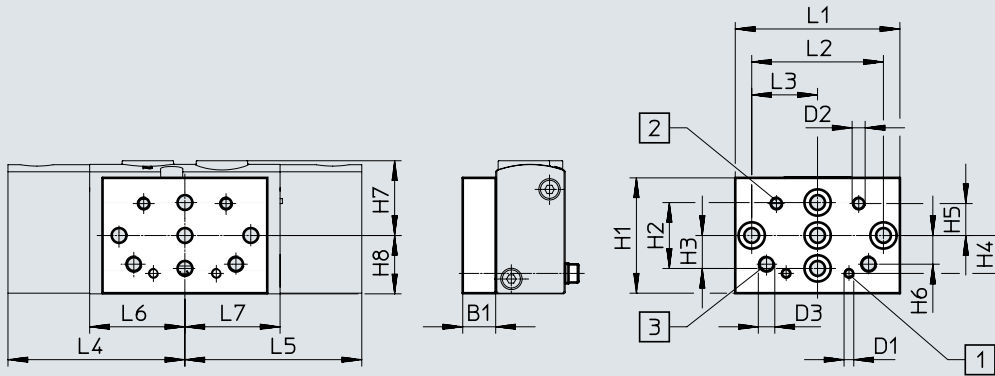

[1] Mounting hole for size 20

[2] Mounting hole for size 25

[3] Mounting hole for size 30



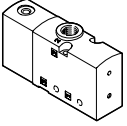
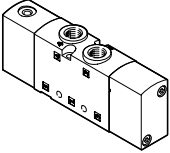
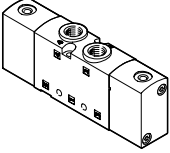

Type		B1	D1	D2	D3	H1	H2	H3	H4	H5	H6
VAME-B10-20-W	VUWS-L20-B52/P53	10	M3	M4	M5	35	20	10	11.5	9.7	8.7
	VUWS-L20-M52										
	VUWS-L20-M32										

Type		H7	H8	L1	L2	L3	L4	L5	L6	L7
VAME-B10-20-W	VUWS-L20-B52/P53	22.7	17.7	50	40	20	53.7	53.7	28.9	28.9
	VUWS-L20-M52									
	VUWS-L20-M32									

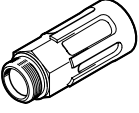

Ordering data

Ordering data – Pneumatic valves				
	Code	Valve function	Part no.	Type
3/2-way valve				
	Normally closed, monostable			
	M32C-A	Reset via pneumatic spring, internal pneumatic spring, flow direction not reversible	575696	VUWS-L20-M32C-A-N18
	M32C-M	Reset via mechanical spring, supported by internal pneumatic spring, flow direction not reversible	575697	VUWS-L20-M32C-M-N18
	Normally open, monostable			
	M32U-A	Reset via pneumatic spring, internal pneumatic spring, flow direction not reversible	575700	VUWS-L20-M32U-A-N18
	M32U-M	Reset via mechanical spring, supported by internal pneumatic spring, flow direction not reversible	575701	VUWS-L20-M32U-M-N18
5/2-way valve				
	Monostable			
	M52-A	Reset via pneumatic spring, internal pneumatic spring, flow direction not reversible	575703	VUWS-L20-M52-A-N18
	M52-M	Reset via mechanical spring, flow direction reversible	575705	VUWS-L20-M52-M-N18
	Bistable			
B52	Flow direction reversible	575707	VUWS-L20-B52-N18	
5/3-way valve				
	Mid-position closed			
	P53C	Reset via mechanical spring, flow direction reversible	575709	VUWS-L20-P53C-M-N18
	Mid-position exhausted			
	P53E	Reset via mechanical spring, flow direction reversible	575713	VUWS-L20-P53E-M-N18
Mid-position pressurised				
P53U	Reset via mechanical spring, flow direction reversible	575711	VUWS-L20-P53U-M-N18	

Accessories

Ordering data		Description	Part no.	Type	PU ¹⁾
Push-in fitting with internal hex					
	Connecting thread 10-32 UNF for tubing O.D.	5/32 "	572312	QBM-10-32-UNF-5/32-I-U	10
	Connecting thread 1/8 NPT for tubing O.D.	5/32 "	572317	QB-1/8-5/32-I-U	10
		1/4 "	572318	QB-1/8-1/4-I-U	10
		5/16 "	572319	QB-1/8-5/16-I-U	10
Angled push-in fitting with external hex					
	Connecting thread 1/8 NPT for tubing O.D.	5/32 "	533290	QBL-1/8-5/32-U	10
		1/4 "	533292	QBL-1/8-1/4-U	10
		5/16 "	533293	QBL-1/8-5/16-U	10
Angled push-in fitting, long, with external hex					
	Connecting thread 1/8 NPT for tubing O.D.	5/32 "	564668	QBLL-1/8-5/32-U	10
		1/4 "	564670	QBLL-1/8-1/4-U	10
		5/16 "	564671	QBLL-1/8-5/16-U	10
Silencer					
	With connecting thread NPT, metal design	1/8 NPT	12638	U-1/8-B-NPT	1
	With connecting thread NPT, sintered design, long	1/8 NPT	1206989	AMTE-M-LH-N18	20

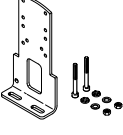
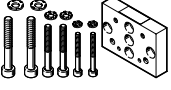
1) Packaging unit

Ordering data		Description	Weight [g]	Part no.	Type
Foot mounting					
	Set for mounting valves, comprising: <ul style="list-style-type: none"> • Mounting bracket and • Screw set for mounting 	97	576412	VAME-B10-20-A	
Wall mounting					
	Set for mounting valves for size 20, 25, 30, comprising: <ul style="list-style-type: none"> • Wall mounting and • Screw set for mounting 	53	576413	VAME-B10-20-W	
Assortment of spare parts					
	Set comprising: <ul style="list-style-type: none"> • Seals and • Screws 	10	8026203	VAME-B10-20-MK	
Inscription label					
	40 pieces in frame	-	565306	ASLR-C-E4	

Data sheet

-  - Flow rate
up to 1300 l/min

-  - Valve width
26.5 mm

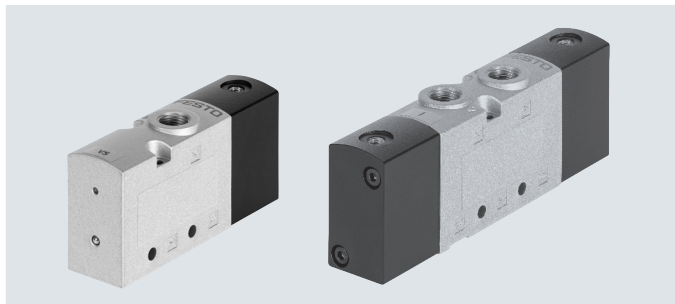

General technical data

Valve function	3/2		5/2		5/3		
Order code for valves	M32C	M32U	M52	B52	P53C	P53U	P53E
Valve width [mm]	26.5						
Design	Piston spool						
Pneumatic spring supply	Internal						
Type of control	Direct						
Manual override (MO)	None						
Flow direction	Reversible with restrictions (not reversible: identified by A in type code)						
Overlap	Positive overlap						
Sealing principle	Soft						
Type of mounting	Optionally via through-holes ¹⁾ or on manifold rail						
Standard nominal flow rate qnN [l/min]	1000	1000	1300	1300	1200	1000	1000
Through-holes (nominal width) [mm]	6.3	6.3	6.9	6.9	6.3	6.3	6.3
Product weight [g]	268	268	330/360 ²⁾	363	364	364	364
Actuation type	Pneumatic						
Mounting position	Any						
Exhaust air function	Can be throttled						
Venting hole	Not ducted						
Pneumatic connection	1, 2, 3	1/4 NPT	1/4 NPT	1/4 NPT	1/4 NPT	1/4 NPT	1/4 NPT
	4, 5	-	-	1/4 NPT	1/4 NPT	1/4 NPT	1/4 NPT
Pneumatic spring connection 12/14, 10	10-32 UNF-2B						

1) If several valves are to be screwed together via through-holes to form a block, a minimum distance of 0.3 mm must be ensured by placing spacer discs between them.

2) With external pneumatic spring: 360 g, with internal pneumatic spring or mechanical spring: 330 g

Technical data – 3/2-way valves

Order code for valves	M32C		M32U	
Normal position	Closed		Open	
Stable position	Monostable			
Reset method	Pneumatic spring		Mechanical spring	
Switching times in [ms]	On	10	10	10
	Off	25	43	25

Data sheet

Technical data – 5/2-way valves			
Order code for valves		M52	B52
Stable position		Monostable	Bistable
Reset method		Pneumatic spring	Mechanical spring
Switching times in [ms]	On	15	10
	Off	32	42
	Change-over	–	10

Technical data – 5/3-way valves				
Order code for valves		P53C	P53U	P53E
Stable position		Monostable		
Reset method		Mechanical spring		
Switching times in [ms]	On	13	13	13
	Off	65	65	65
	Change-over	30	30	30

Safety characteristics	
Shock resistance	Shock test with severity level 2 to FN 942017-5 and EN 60068-2-27
Vibration resistance	Transport application test with severity level 2 to FN 942017-4 and EN 60068-2-6

Operating and environmental conditions							
Valve function		M32 ... A	M32 ... M	M52-A	M52-M	B52	P53
Operating medium		Compressed air to ISO 8573-1:2010 [7:4:4]					
Pilot medium		Compressed air to ISO 8573-1:2010 [7:4:4]					
Note on the operating/pilot medium		Lubricated operation possible (in which case lubricated operation will always be required)					
Operating pressure	[MPa]	0.25 ... 1	–0.09 ... +1	0.25 ... 1	–0.09 ... +1	–0.09 ... +1	–0.09 ... +1
	[bar]	2.5 ... 10	–0.9 ... +10	2.5 ... 10	–0.9 ... +10	–0.9 ... +10	–0.9 ... +10
Pilot pressure	[MPa]	0.25 ... 1	0.25 ... 1	0.25 ... 1	0.25 ... 1	0.15 ... 1	0.25 ... 1
	[bar]	2.5 ... 10	2.5 ... 10	2.5 ... 10	2.5 ... 10	1.5 ... 10	2.5 ... 10
Ambient temperature	[°C]	–10 ... +60					
Temperature of medium	[°C]	–10 ... +60					
Certification		c UL us - Recognized (OL)					
Corrosion resistance class CRC ¹⁾		2					

1) More information: www.festo.com/x/topic/kbk

Information on materials	
Housing	Die-cast aluminium (painted)
Seals	HNBR, NBR
Piston spool	Wrought aluminium alloy
Screws	Galvanised steel
Note on materials	RoHS-compliant

Data sheet

Dimensions

Download CAD data → www.festo.com

3/2-way valve, normally closed/open

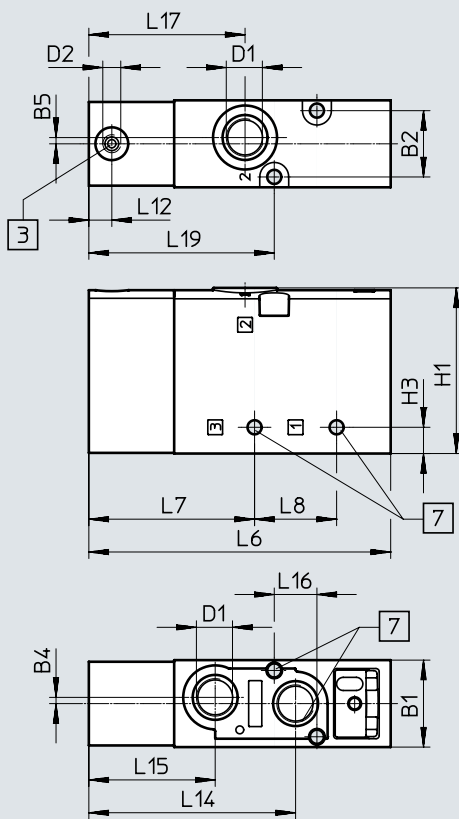

- [3] Port 10: for pilot air (...-M32U-...)
- Port 12: for pilot air (...-M32C-...)
- [7] For retaining screw M4

Type	B1	B2	B3	B4	B5	D1	D2	H1	H3
VUWS-L25-M32C-...-N14	26.5	20.2	1.9	1.9	1.9	1/4 NPT	10-32 UNF-2B	50.5	8
VUWS-L25-M32U-...-N14									

Type	L6	L7	L8	L12	L14	L15	L16	L17	L19
VUWS-L25-M32C-...-N14	92	50.5	25	7	63	38.5	13	47.6	56.5
VUWS-L25-M32U-...-N14									

Data sheet

Dimensions

Download CAD data → www.festo.com

5/2-way monostable valve

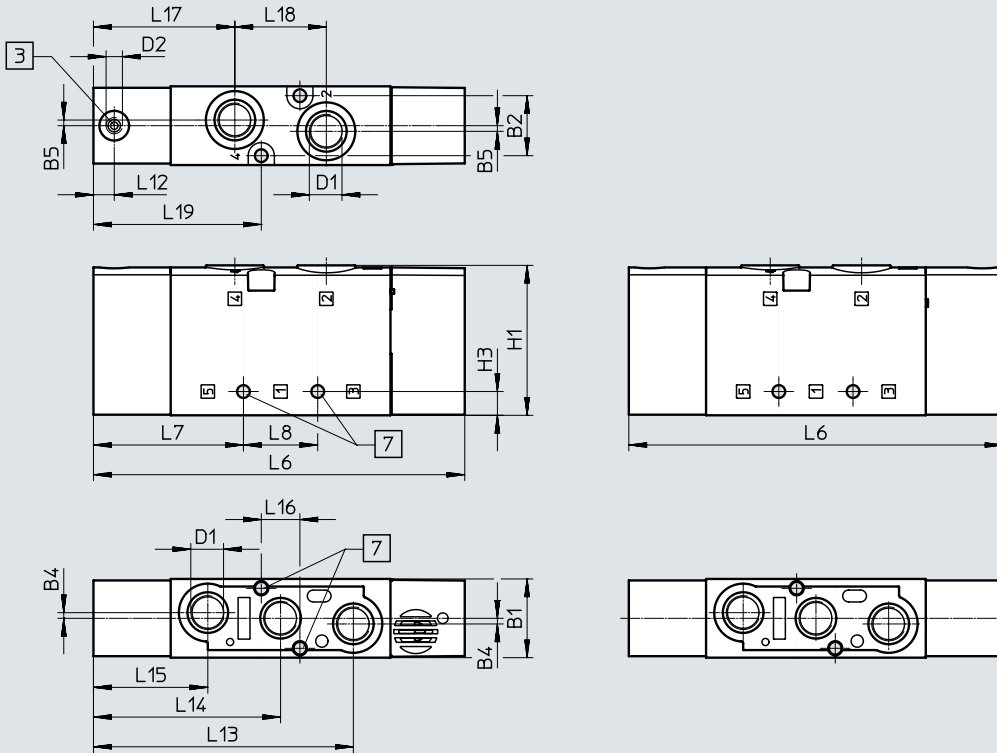

- [3] Port 14: for pilot air (-M52-A-...)
- [7] For retaining screw M4

Type	B1	B2	B4	B5	D1	D2	H1	H3
VUWS-L25-M52-...-N14	26.5	20.2	1.9	1.9	1/4 NPT	10-32 UNF-2B	50.5	8

Type	L6	L7	L8	L12	L13	L14	L15	L16	L17	L18	L19
VUWS-L25-M52-...-N14	125	50.5	25	7	87.5	63	38.5	13	47.6	30.8	56.5

Data sheet

Dimensions

Download CAD data → www.festo.com

5/2-way valve, bistable, 5/3-way valve

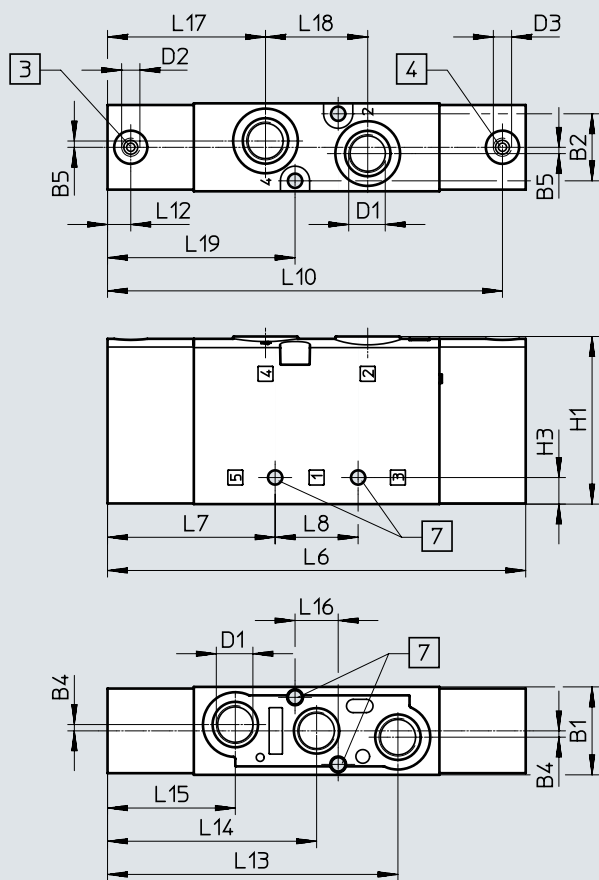

- [3] Port 14: for pilot air
- [4] Port 12: for pilot air
- [7] For retaining screw M4

Type	B1	B2	B4	B5	D1	D2	D3	H1	H3
VUWS-L25-P53...-M-N14	26.5	20.2	1.9	1.9	1/4 NPT	10-32 UNF-2B	10-32 UNF-2B	50.5	8
VUWS-L25-B52-N14									

Type	L6	L7	L8	L10	L12	L13	L14	L15	L16	L17	L18	L19
VUWS-L25-P53...-M-N14	126	50.5	25	119	7	87.5	63	38.5	13	47.6	30.8	56.5
VUWS-L25-B52-N14												

Data sheet

Dimensions

Foot mounting

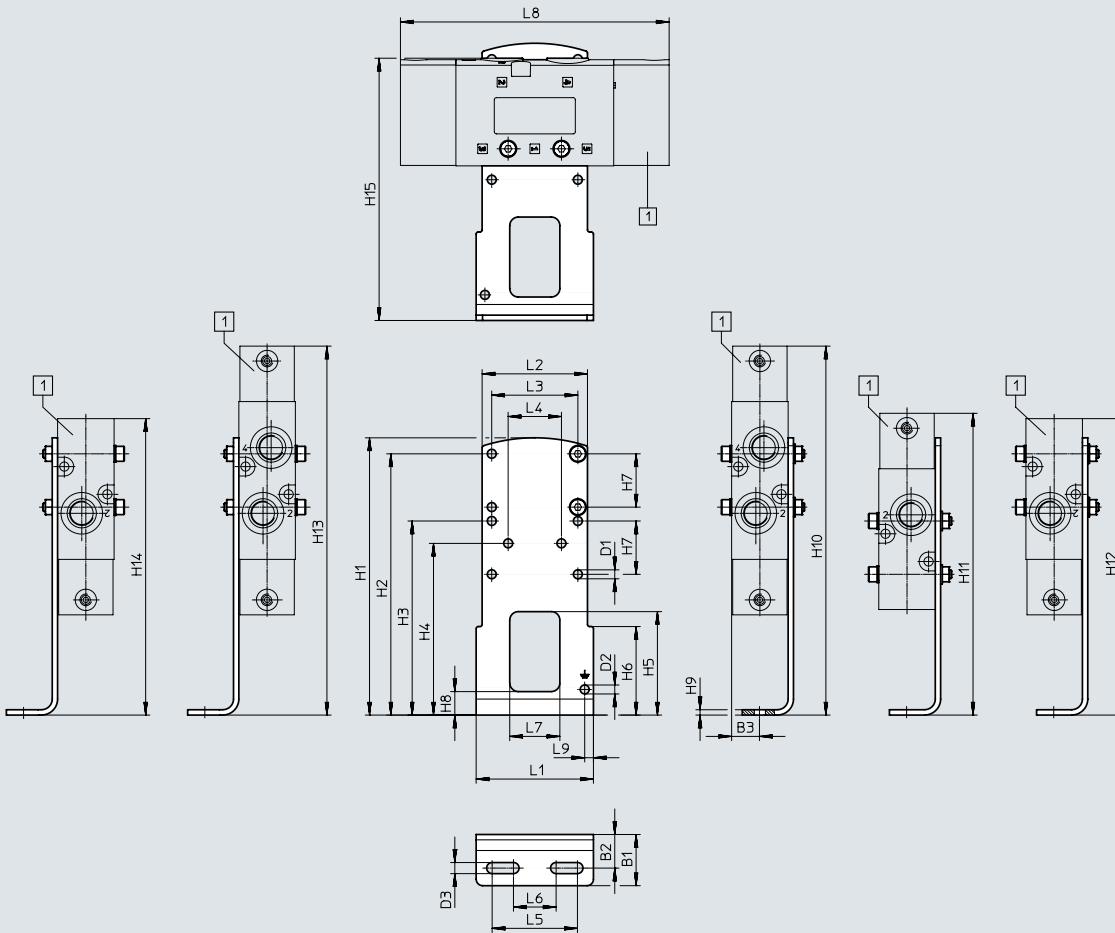

[1] VUWS-L25-B52,
VUWS-L25-P53,
VUWS-L25-M52,
VUWS-L25-M32

Type		B1	B2	B3	D1 ∅	D2 ∅	D3	H1	H2	H3	H4
VAME-B10-25-A	VUWS-L25-B52/P53	24	15.8	13.3	4.2	4.2	5.2	130	122.5	91	80.5
	VUWS-L25-M52-E										
	VUWS-L25-M52										
	VUWS-L25-M32										

Type		H5	H6	H7	H8	H9	H10	H11	H12	H13	H14
VAME-B10-25-A	VUWS-L25-B52/P53	48.5	41.5	25	11	2.5	173	141.5	173	173	173
	VUWS-L25-M52-E								172		172
	VUWS-L25-M52								139		139
	VUWS-L25-M32										139

Type		H15	L1	L2	L3	L4	L5	L6	L7	L8	L9
VAME-B10-25-A	VUWS-L25-B52/P53	123	55	49.4	40.4	25	40	20	23.5	126	4.1
	VUWS-L25-M52-E									125	
	VUWS-L25-M52									92	
	VUWS-L25-M32										

Data sheet

Dimensions

Wall mounting

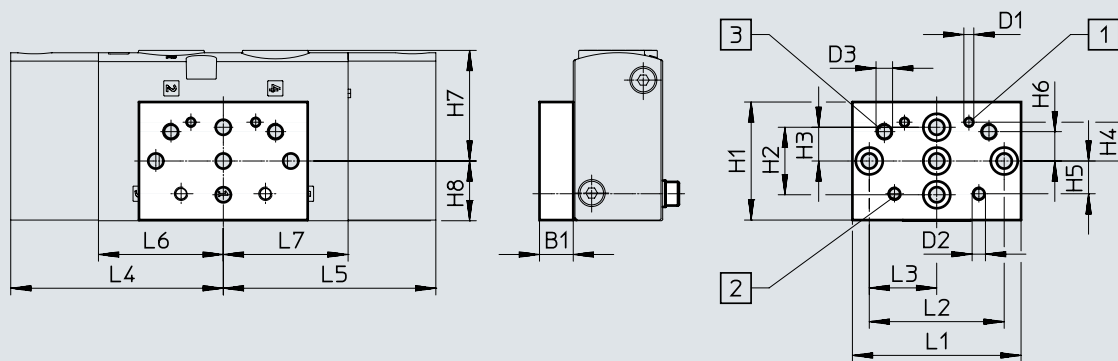

[1] Mounting hole for size 20

[2] Mounting hole for size 25

[3] Mounting hole for size 30



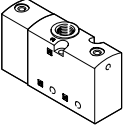
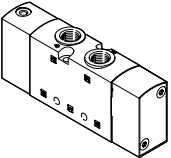
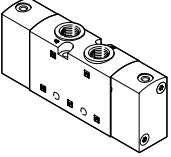

Type		B1	D1	D2	D3	H1	H2	H3	H4	H5	H6
VAME-B10-20-W	VUWS-L25-B52/P53	10	M3	M4	M5	35	20	10	11.5	9.7	8.7
	VUWS-L25-M52-E										
	VUWS-L25-M52										
	VUWS-L25-M32										

Type		H7	H8	L1	L2	L3	L4	L5	L6	L7
VAME-B10-20-W	VUWS-L25-B52/P53	32.8	17.7	50	40	20	63	63	37	37
	VUWS-L25-M52-E									
	VUWS-L25-M52									
	VUWS-L25-M32									

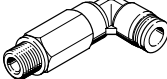
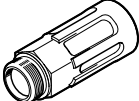

Ordering data

Ordering data – Pneumatic valves				
	Code	Valve function	Part no.	Type
3/2-way valve				
	Normally closed, monostable			
	M32C-A	Reset via pneumatic spring, internal pneumatic spring, flow direction not reversible	575546	VUWS-L25-M32C-A-N14
	M32C-M	Reset via mechanical spring, internal pneumatic spring, flow direction reversible	575547	VUWS-L25-M32C-M-N14
	Normally open, monostable			
	M32U-A	Reset via pneumatic spring, internal pneumatic spring, flow direction not reversible	575550	VUWS-L25-M32U-A-N14
	M32U-M	Reset via mechanical spring, internal pneumatic spring, flow direction reversible	575551	VUWS-L25-M32U-M-N14
5/2-way valve				
	Monostable			
	M52-A	Reset via pneumatic spring, internal pneumatic spring, flow direction not reversible	575553	VUWS-L25-M52-A-N14
	M52-M	Reset via mechanical spring, flow direction reversible	575555	VUWS-L25-M52-M-N14
	Bistable			
B52	Flow direction reversible	575557	VUWS-L25-B52-N14	
5/3-way valve				
	Mid-position closed			
	P53C	Reset via mechanical spring, flow direction reversible	575559	VUWS-L25-P53C-M-N14
	Mid-position exhausted			
	P53E	Reset via mechanical spring, flow direction reversible	575563	VUWS-L25-P53E-M-N14
Mid-position pressurised				
P53U	Reset via mechanical spring, flow direction reversible	575561	VUWS-L25-P53U-M-N14	

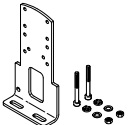
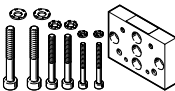

Accessories

Ordering data	Description	Part no.	Type	PU ¹⁾	
Push-in fitting with internal hex					
	Connecting thread 10-32 UNF for tubing O.D.	5/32 "	572312	QBM-10-32-UNF-5/32-I-U	10
	Connecting thread 1/4 NPT for tubing O.D.	1/4 "	572320	QB-1/4-1/4-I-U	10
		5/16 "	572321	QB-1/4-5/16-I-U	10
		3/8 "	572322	QB-1/4-3/8-I-U	10
Angled push-in fitting with external hex					
	Connecting thread 1/4 NPT for tubing O.D.	1/4 "	533295	QBL-1/4-1/4-U	10
		5/16 "	533296	QBL-1/4-5/16-U	10
		3/8 "	533297	QBL-1/4-3/8-U	5
Angled push-in fitting, long, with external hex					
	Connecting thread 1/4 NPT for tubing O.D.	1/4 "	564674	QBL-1/4-1/4-U	10
		5/16 "	564675	QBL-1/4-5/16-U	10
		3/8 "	564676	QBL-1/4-3/8-U	5
Silencer					
	With connecting thread NPT, metal design	1/4 NPT	12639	U-1/4-B-NPT	1
	With connecting thread NPT, sintered design, long	1/4 NPT	1206990	AMTE-M-LH-N14	20

1) Packaging unit

Ordering data	Description	Weight [g]	Part no.	Type
Foot mounting				
	Set for mounting valves, comprising: <ul style="list-style-type: none"> • Mounting bracket and • Screw set for mounting 	130	2293485	VAME-B10-25-A
Wall mounting				
	Set for mounting valves for size 20, 25, 30, comprising: <ul style="list-style-type: none"> • Wall mounting and • Screw set for mounting 	53	576413	VAME-B10-20-W
Assortment of spare parts				
	Set comprising: <ul style="list-style-type: none"> • Seals and • Screws 	12	8035636	VAME-B10-25-MK
Inscription label				
	40 pieces in frame	-	565306	ASLR-C-E4

Data sheet

-  Flow rate
up to 2300 l/min
-  Valve width
31 mm

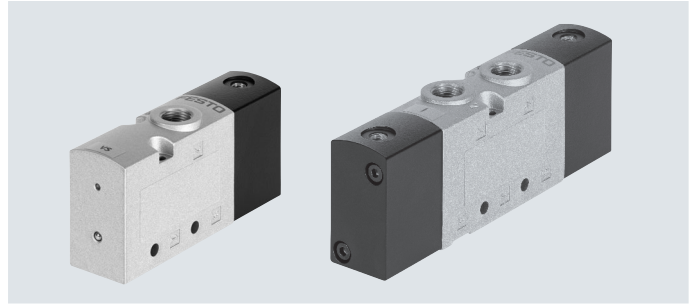

General technical data

Valve function	3/2		5/2		5/3		
Order code for valves	M32C	M32U	M52	B52	P53C	P53U	P53E
Valve width [mm]	31						
Design	Piston spool						
Pneumatic spring supply	Internal or external						
Type of control	Direct						
Manual override (MO)	None						
Flow direction	Reversible with restrictions (not reversible: identified by A in type code)						
Sealing principle	Soft						
Type of mounting	Optionally via through-holes ¹⁾ or on manifold rail						
Standard nominal flow rate qnN [l/min]	2300	2300	2300	2300	2000	1600	1600
Through-holes (nominal width) [mm]	9.4	9.4	9.4	9.4	8.9	8.1	8.1
Product weight [g]	394	394	487/546 ²⁾	545	542	542	542
Actuation type	Pneumatic						
Overlap	Positive overlap						
Mounting position	Any						
Exhaust air function	Can be throttled						
Venting hole	Not ducted						
Pneumatic connection	1, 2, 3	3/8 NPT	3/8 NPT	3/8 NPT	3/8 NPT	3/8 NPT	3/8 NPT
	4, 5	-	-	3/8 NPT	3/8 NPT	3/8 NPT	3/8 NPT
Pneumatic spring connection 12/14, 10	1/8 NPT						

1) If several valves are to be screwed together via through-holes to form a block, a minimum distance of 0.3 mm must be ensured by placing spacer discs between them.

2) With external pneumatic spring: 546 g, with internal pneumatic spring or mechanical spring: 487 g

Technical data – 3/2-way valves

Order code for valves	M32C-A	M32C-M	M32U-A	M32U-M
Normal position	Closed		Open	
Stable position	Monostable			
Reset method	Pneumatic spring		Mechanical spring	
Switching times in [ms]	On	19	16	19
	Off	36	73	37

Data sheet

Technical data – 5/2-way valves				
Order code for valves		M52	B52	
Stable position		Monostable		Bistable
Reset method		Pneumatic spring	Mechanical spring	–
Switching times in [ms]	On	24	17	–
	Off	59	77	–
	Change-over	–	–	13

Technical data – 5/3-way valves					
Order code for valves		P53C	P53U	P53E	
Stable position		Monostable			
Reset method		Mechanical spring			
Switching times in [ms]	On	19	19	19	
	Off	98	98	98	
	Change-over	41	41	41	

Safety characteristics	
Shock resistance	Shock test with severity level 2 to FN 942017-5 and EN 60068-2-27
Vibration resistance	Transport application test with severity level 2 to FN 942017-4 and EN 60068-2-6

Operating and environmental conditions						
Valve function		M32	M52-A	M52-M	B52	P53
Operating medium		Compressed air to ISO 8573-1:2010 [7:4:4]				
Pilot medium		Compressed air to ISO 8573-1:2010 [7:4:4]				
Note on the operating/pilot medium		Lubricated operation possible (in which case lubricated operation will always be required)				
Operating pressure	[MPa]	–0.09 ... +1	0.25 ... 1	–0.09 ... +1	–0.09 ... +1	–0.09 ... +1
	[bar]	–0.9 ... +10	2.5 ... 10	–0.9 ... +10	–0.9 ... +10	–0.9 ... +10
Pilot pressure	[MPa]	0.25 ... 1	0.25 ... 1	0.25 ... 1	0.15 ... 1	0.25 ... 1
	[bar]	2.5 ... 10	2.5 ... 10	2.5 ... 10	1.5 ... 10	2.5 ... 10
Ambient temperature	[°C]	–10 ... +60				
Temperature of medium	[°C]	–10 ... +60				
Certification		cUL us - Recognized (OL)				
Corrosion resistance class CRC ¹⁾		2				

1) More information: www.festo.com/x/topic/kbk

Information on materials	
Housing	Die-cast aluminium (painted)
Seals	HNBR, NBR
Piston spool	Wrought aluminium alloy
Screws	Nickel-plated steel
Note on materials	RoHS-compliant

Data sheet

Dimensions

Download CAD data → www.festo.com

3/2-way valve, normally closed/open

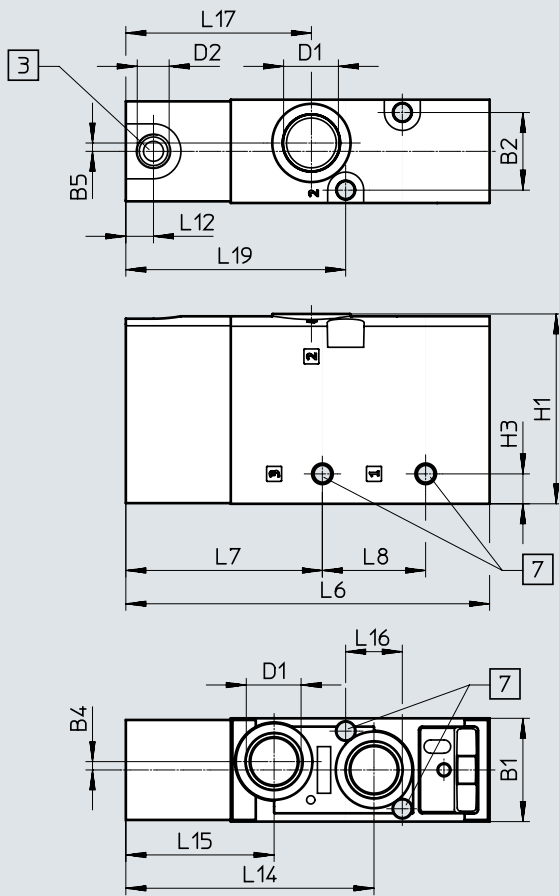

- [3] Port 10: pilot air (...-M32U-...)
Port 12: pilot air (...-M32C-...)
- [7] For retaining screw M5

Type	B1	B2	B3	B4	B5	D1	D2	H1	H3
VUWS-L30-M32C-...-N38	31	23.3	2.5	2.5	2.5	3/8 NPT	1/8 NPT	57	9
VUWS-L30-M32U-...-N38									

Type	L6	L7	L8	L12	L14	L15	L16	L17	L19
VUWS-L30-M32C-...-N38	109.2	59	31	8.3	74.5	44.5	17	55.7	66
VUWS-L30-M32U-...-N38									

Data sheet

Dimensions

Download CAD data → www.festo.com

5/2-way monostable valve

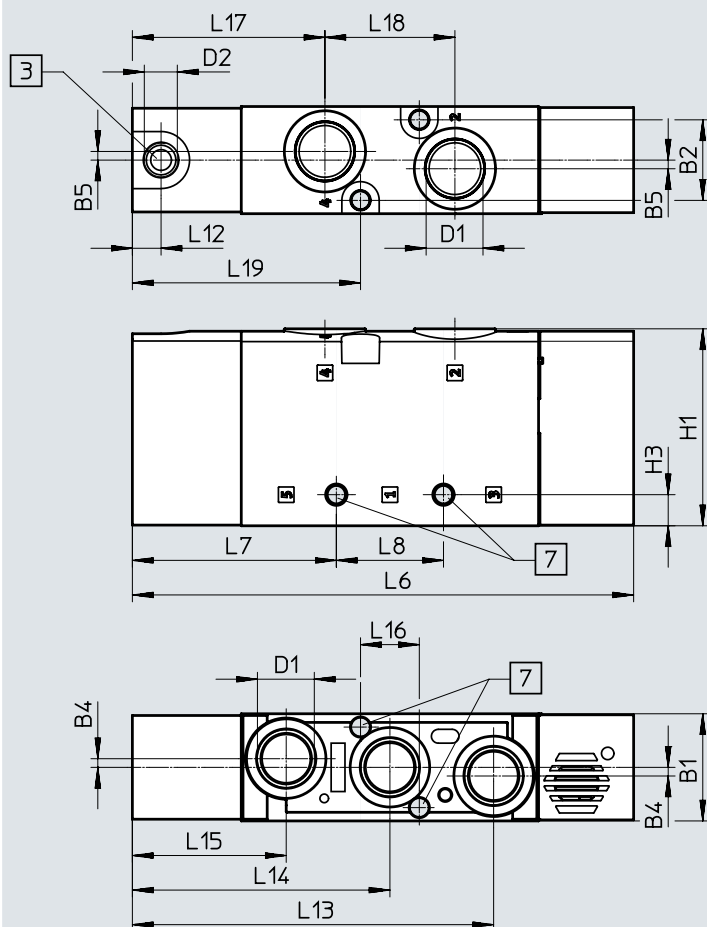

[3] Port 14: pilot air (-M52-...)

[7] For retaining screw M5

Type	B1	B2	B4	B5	D1	D2	H1	H3
VUWS-L30-M52-...-N38	31	23.3	2.5	2.5	3/8 NPT	1/8 NPT	57	9

Type	L6	L7	L8	L12	L13	L14	L15	L16	L17	L18	L19
VUWS-L30-M52-...-N38	145	59	31	8.3	104.5	74.5	44.5	17	55.7	37.6	66

Data sheet

Dimensions

Download CAD data → www.festo.com

5/2-way valve, bistable, 5/3-way valve

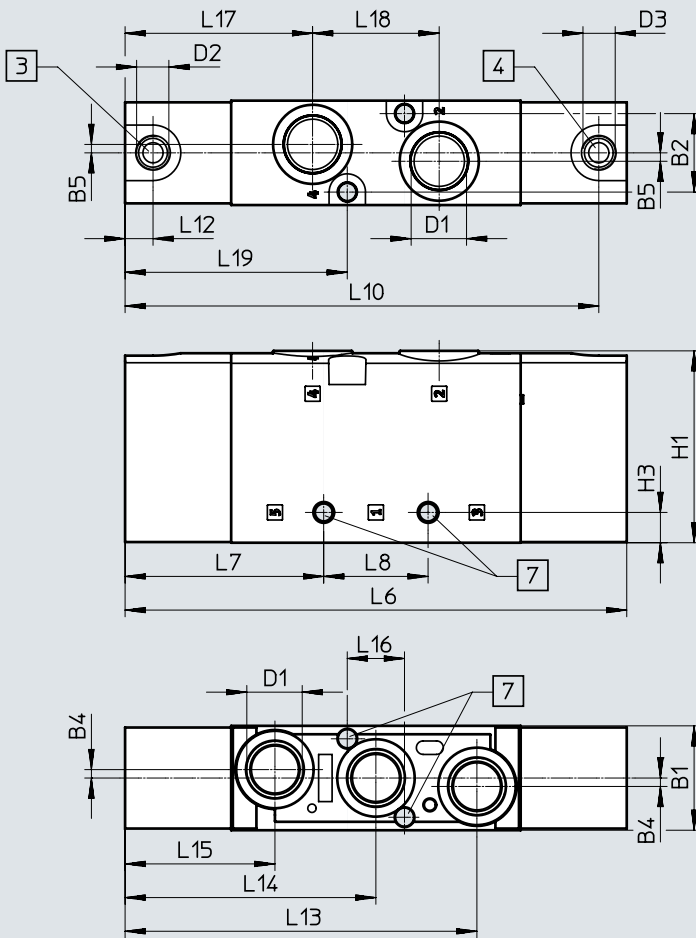

- [3] Port 14: pilot air
- [4] Port 12: pilot air
- [7] For retaining screw M5

Type	B1	B2	B4	B5	D1	D2	D3	H1	H3
VUWS-L30-P53...-M-N38	31	23.3	2.5	2.5	3/8 NPT	1/8 NPT	1/8 NPT	57	9
VUWS-L30-B52-N38									

Type	L6	L7	L8	L10	L12	L13	L14	L15	L16	L17	L18	L19
VUWS-L30-P53...-M-N38	149	59	31	140.7	8.3	104.5	74.5	44.5	17	55.7	37.6	66
VUWS-L30-B52-N38												

Data sheet

Dimensions

Foot mounting

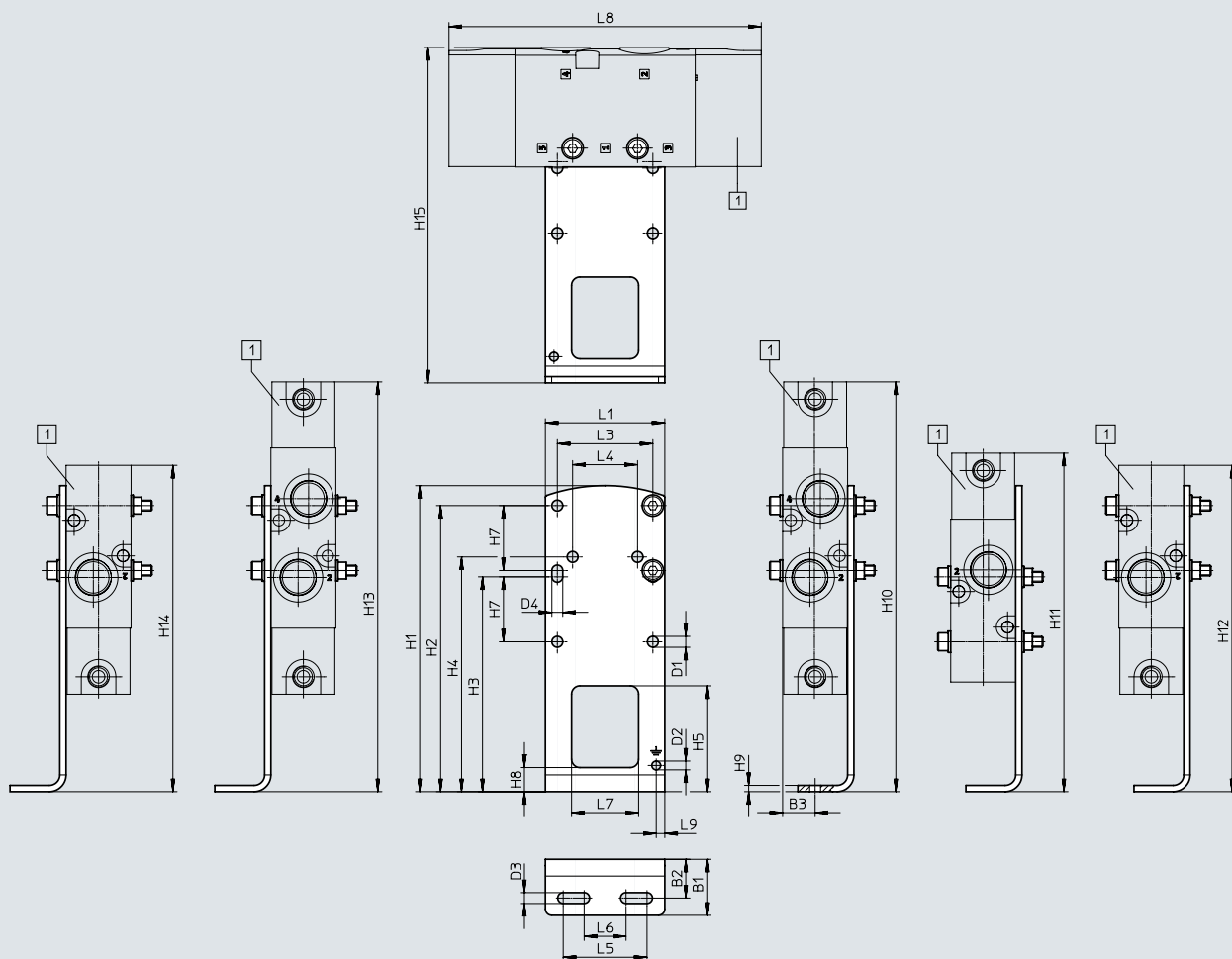

[1] VUWS-L30-B52,
VUWS-L30-P53,
VUWS-L30-M52,
VUWS-L30-M32

Type		B1	B2	B3	D1 ∅	D2 ∅	D3	D4	H1	H2	H3
VAME-B10-30-A	VUWS-L30-B52/P53	26.8	18.5	15.5	5.2	4.2	5.2	5.2	146	136.5	102.5
	VUWS-L30-M52-E										
	VUWS-L30-M52										
	VUWS-L30-M32										

Type		H4	H5	H7	H8	H9	H10	H11	H12	H13	H14		
VAME-B10-30-A	VUWS-L30-B52/P53	112	50.5	31	11.5	3	195.5	161.5	195.5	195.5	195.5		
	VUWS-L30-M52-E												
	VUWS-L30-M52											191.5	191.5
	VUWS-L30-M32											155.7	155.7

Type		H15	L1	L3	L4	L5	L6	L7	L8	L9	
VAME-B10-30-A	VUWS-L30-B52/P53	160	57	45.6	31	40	20	32	149	4.1	
	VUWS-L30-M52-E										
	VUWS-L30-M52										145
	VUWS-L30-M32										109.2

Data sheet

Dimensions

Wall mounting

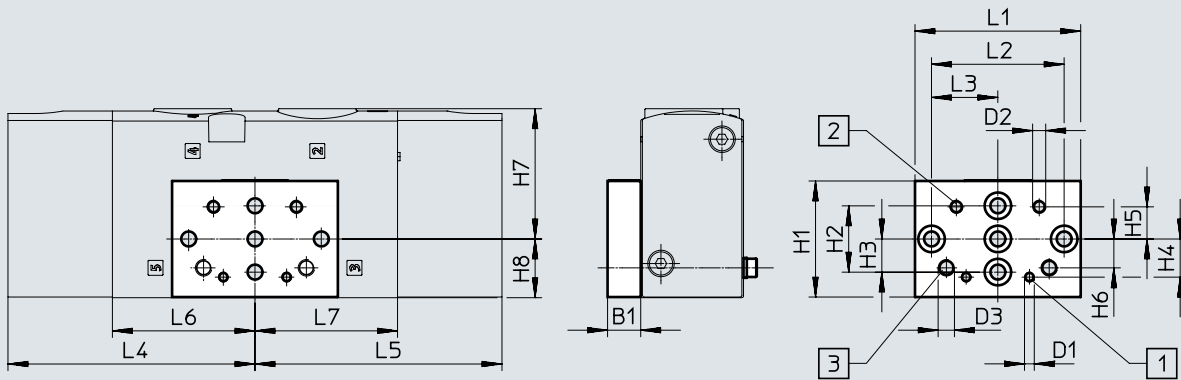

[1] Mounting hole for size 20

[2] Mounting hole for size 25

[3] Mounting hole for size 30



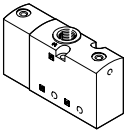
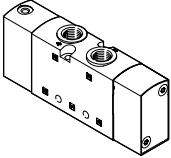
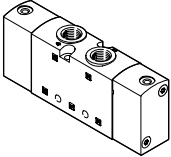

Type		B1	D1	D2	D3	H1	H2	H3	H4	H5	H6
VAME-B10-20-W	VUWS-L30-B52/P53	10	M3	M4	M5	35	20	10	11.5	9.7	8.7
	VUWS-L30-M52										
	VUWS-L30-M32										

Type		H7	H8	L1	L2	L3	L4	L5	L6	L7
VAME-B10-20-W	VUWS-L30-B52/P53	39.3	17.7	50	40	20	74.5	74.5	43	43
	VUWS-L30-M52									-
	VUWS-L30-M32									-

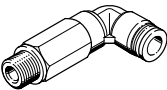
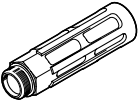

Ordering data

Ordering data – Pneumatic valves				
	Code	Valve function	Part no.	Type
3/2-way valve				
	Normally closed, monostable			
	M32C-A	Reset via pneumatic spring, internal pneumatic spring, flow direction not reversible	575639	VUWS-L30-M32C-A-N38
	M32C-M	Reset via mechanical spring, flow direction reversible	575640	VUWS-L30-M32C-M-N38
	Normally open, monostable			
	M32U-A	Reset via pneumatic spring, internal pneumatic spring, flow direction not reversible	575643	VUWS-L30-M32U-A-N38
	M32U-M	Reset via mechanical spring, flow direction reversible	575644	VUWS-L30-M32U-M-N38
5/2-way valve				
	Monostable			
	M52-A	Reset via pneumatic spring, internal pneumatic spring, flow direction not reversible	575646	VUWS-L30-M52-A-N38
	M52-M	Reset via mechanical spring, flow direction reversible	575648	VUWS-L30-M52-M-N38
	Bistable			
B52	Flow direction reversible	575650	VUWS-L30-B52-N38	
5/3-way valve				
	Mid-position closed			
	P53C	Reset via mechanical spring, flow direction reversible	575652	VUWS-L30-P53C-M-N38
	Mid-position exhausted			
	P53E	Reset via mechanical spring, flow direction reversible	575656	VUWS-L30-P53E-M-N38
Mid-position pressurised				
P53U	Reset via mechanical spring, flow direction reversible	575654	VUWS-L30-P53U-M-N38	

Accessories

Ordering data		Description	Part no.	Type	PU ¹⁾
Push-in fitting with internal hex					
	Connecting thread 1/8 NPT for tubing O.D.	1/4 "	572318	QB-1/8-1/4-I-U	10
	Connecting thread 3/8 NPT for tubing O.D.	5/16 "	572323	QB-3/8-5/16-I-U	10
		3/8 "	572324	QB-3/8-3/8-I-U	10
		1/2 "	572325	QB-3/8-1/2-I-U	10
Angled push-in fitting with external hex					
	Connecting thread 3/8 NPT for tubing O.D.	5/16 "	533299	QBL-3/8-5/16-U	5
		3/8 "	533300	QBL-3/8-3/8-U	5
		1/2 "	533301	QBL-3/8-1/2-U	5
Angled push-in fitting, long, with external hex					
	Connecting thread 3/8 NPT for tubing O.D.	5/16 "	564679	QBLL-3/8-5/16-U	5
		3/8 "	564680	QBLL-3/8-3/8-U	5
		1/2 "	564681	QBLL-3/8-1/2-U	5
Silencer					
	With connecting thread NPT, metal design	3/8 NPT	12740	U-3/8-B-NPT	1
	With connecting thread NPT, sintered design, long	3/8 NPT	1206991	AMTE-M-LH-N38	10

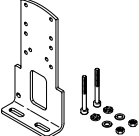
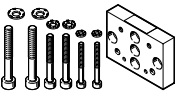
1) Packaging unit

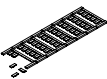
Ordering data		Description	Weight [g]	Part no.	Type
Foot mounting					
	Set for mounting valves, comprising: <ul style="list-style-type: none"> • Mounting bracket and • Screw set for mounting 	–	8026337	VAME-B10-30-A	
Wall mounting					
	Set for mounting valves for size 20, 25, 30, comprising: <ul style="list-style-type: none"> • Wall mounting and • Screw set for mounting 	53	576413	VAME-B10-20-W	
Assortment of spare parts					
	Set comprising: <ul style="list-style-type: none"> • Seals and • Screws 	–	8035637	VAME-B10-30-MK	
Inscription label					
	40 pieces in frame	–	565306	ASLR-C-E4	

Data sheet – Manifold block, size 20

-  - Flow rate
up to 700 l/min

-  - Valve width
21 mm



General technical data					
	Manifold block standard		Manifold block compact		Common supply manifold on both sides
Valve function	3/2	5/2, 5/3	3/2	5/2, 5/3	3/2, 5/2, 5/3
Grid dimension [mm]	22				
Type of mounting	With through-hole				With mounting bracket
Max. number of valve positions	10	10	10		10
Port 1	3/8 NPT	3/8 NPT	1/4 NPT	1/4 NPT	3/8 NPT
Port 3	3/8 NPT	3/8 NPT	1/4 NPT	1/4 NPT	-
Port 5	-	3/8 NPT	-	1/4 NPT	-
Port 12	1/8 NPT	1/8 NPT	-	-	-
Port 14	-	1/8 NPT	-	-	-
CRC ¹⁾	2 ¹⁾				

1) More information: www.festo.com/x/topic/kbk

Weight [g]										
Valve positions	2	3	4	5	6	7	8	9	10	
Manifold block for 3/2-way valves, standard										
VABM-B10-20E-N38-...-P3	449	574	699	825	950	1075	1200	1326	1451	
Manifold block for 5/2- and 5/3-way valves, standard										
VABM-B10-20E-N38-...	680	866	1053	1239	1425	1612	1798	1985	2171	
Manifold block for 3/2-way valves, compact										
VABM-B10-20S-N14-...-P3	280	360	441	521	601	681	762	842	922	
Manifold block for 5/2- and 5/3-way valves, compact										
VABM-B10-20S-N14-...	344	439	535	630	726	821	917	1012	1108	
Common supply manifold for mounting on both sides										
VABM-B10-20-N38-...-P53	226	268	310	352	395	437	479	521	563	

Information on materials	
Information on materials	Wrought aluminium alloy
Note on materials	RoHS-compliant

Data sheet – Manifold block, size 20

Dimensions

Manifold block for 3/2-way valves, standard

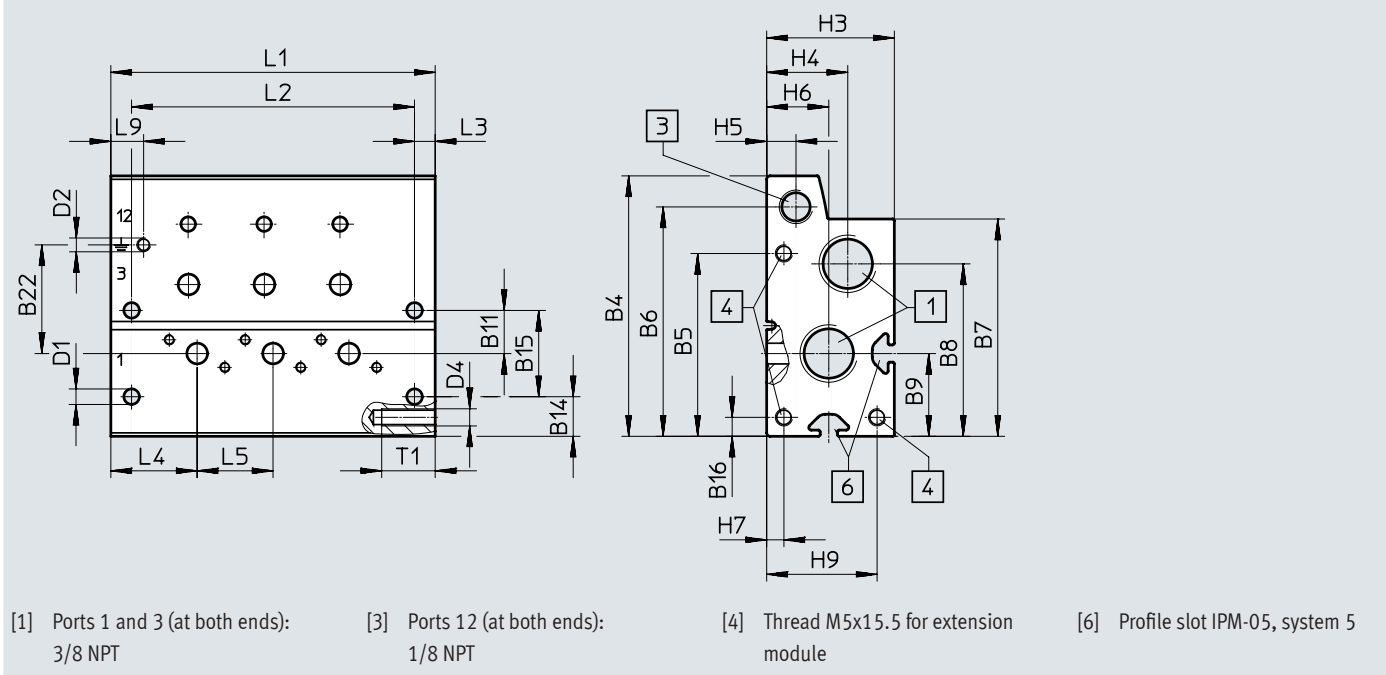

Type	B4	B5	B6	B7	B8	B9	B11	B14	B15	B16	B22
VABM-B10-20E-N38-...-P3	75.5	53	66.5	63	50	24	12.5	11.5	25	5.5	31.5

Type	D1 \varnothing	D2	D4	H3	H4	H5	H6	H7	H9	L3	L4	L5	L9	T1
VABM-B10-20E-N38-...-P3	4.5	M4x6.5	M5	37	23.5	8.5	18	5	32	6	25	22	9.5	15.5

Valve positions	2	3	4	5	6	7	8	9	10
L1 [mm]	72	94	116	138	160	182	204	226	248
L2 [mm]	60	82	104	126	148	170	192	214	236

Data sheet – Manifold block, size 20

Dimensions

Manifold block for 5/2- and 5/3-way valves, standard

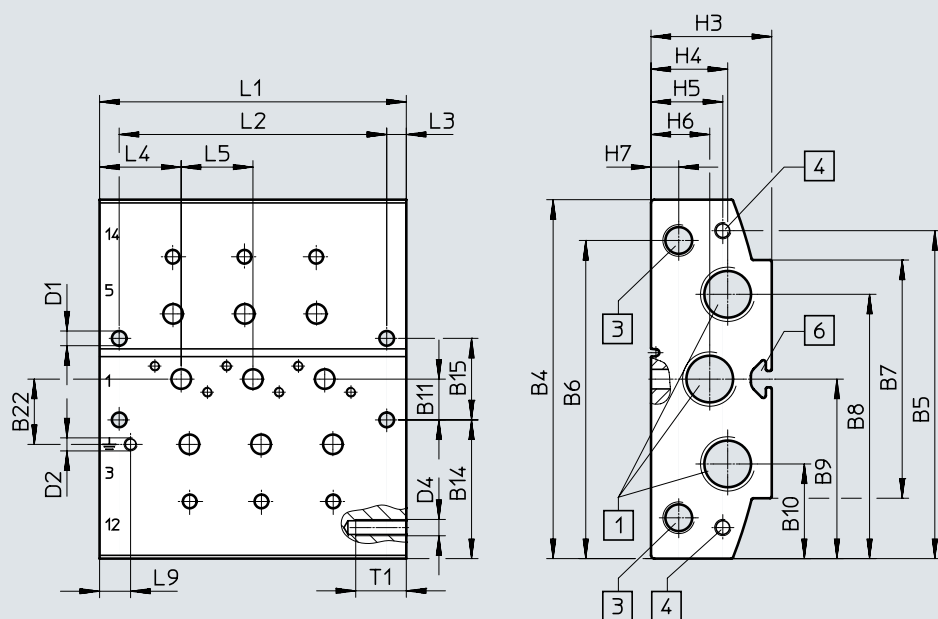

[1] Ports 1, 3 and 5 (at both ends):
3/8 NPT

[3] Ports 12 and 14 (at both ends):
1/8 NPT

[4] Thread M5x15.5 for extension
module

[6] Profile slot IPM-05, system 5

Type	B4	B5	B6	B7	B8	B9	B10	B11	B14	B15	B22
VABM-B10-20E-N38-...	110	100.5	97.5	73	81	55	29	12.5	42.5	25	20

Type	D1 ø	D2	D4	H3	H4	H5	H6	H7	L3	L4	L5	L9	T1
VABM-B10-20E-N38-...	4.5	M4x6.5	M5	37	23.5	22	18	8.5	6	25	22	9.5	15.5

Valve positions	2	3	4	5	6	7	8	9	10
L1 [mm]	72	94	116	138	160	182	204	226	248
L2 [mm]	60	82	104	126	148	170	192	214	236

Data sheet – Manifold block, size 20

Dimensions

Manifold block for 3/2-way valves, compact

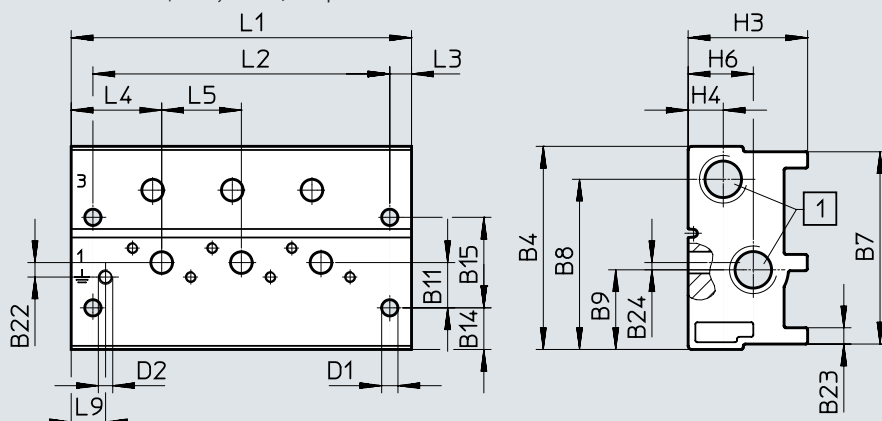

[1] Ports 1 and 3 (at both ends):
1/4 NPT

Type	B4	B7	B8	B9	B11	B14	B15	B22	B23	B24
VABM-B10-20S-N14-...-P3	56.1	53.1	471	22	12.5	11.5	25	4	5	2

Type	D1 ø	D2	H3	H4	H6	L3	L4	L5	L9
VABM-B10-20S-N14-...-P3	4.5	M4x6.5	33	9.7	18	6	25	22	9.5

Valve positions	2	3	4	5	6	7	8	9	10
L1 [mm]	72	94	116	138	160	182	204	226	248
L2 [mm]	60	82	104	126	148	170	192	214	236

Dimensions

Manifold block for 5/2- and 5/3-way valves, compact

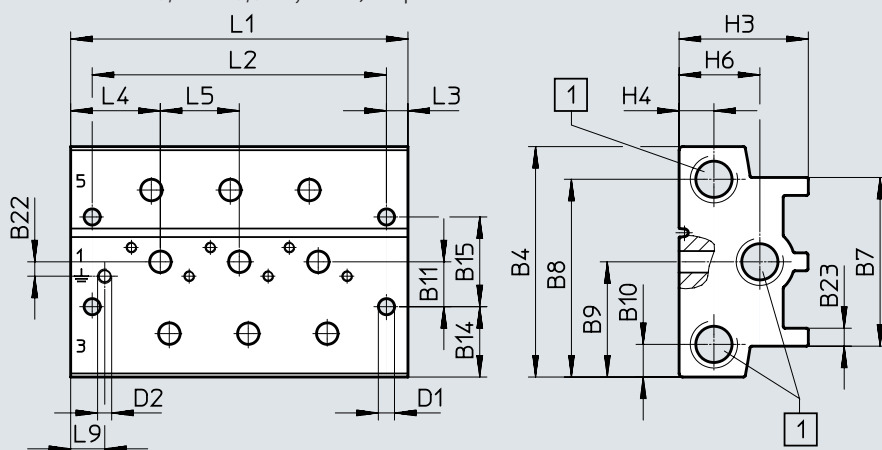

[1] Ports 1, 3 and 5 (at both ends):
1/4 NPT

Type	B4	B7	B8	B9	B10	B11	B14	B15	B22	B23
VABM-B10-20S-N14-...	64.2	47	55.1	32.1	9.1	12.5	149.6	25	4	5

Type	D1 ø	D2	H3	H4	H6	L3	L4	L5	L9
VABM-B10-20S-N14-...	4.5	M4x6.5	36	9.7	22.5	6	25	22	9.5

Valve positions	2	3	4	5	6	7	8	9	10
L1 [mm]	72	94	116	138	160	182	204	226	248
L2 [mm]	60	82	104	126	148	170	192	214	236

Data sheet – Manifold block, size 20

Dimensions

Common supply manifold, mounting on both sides

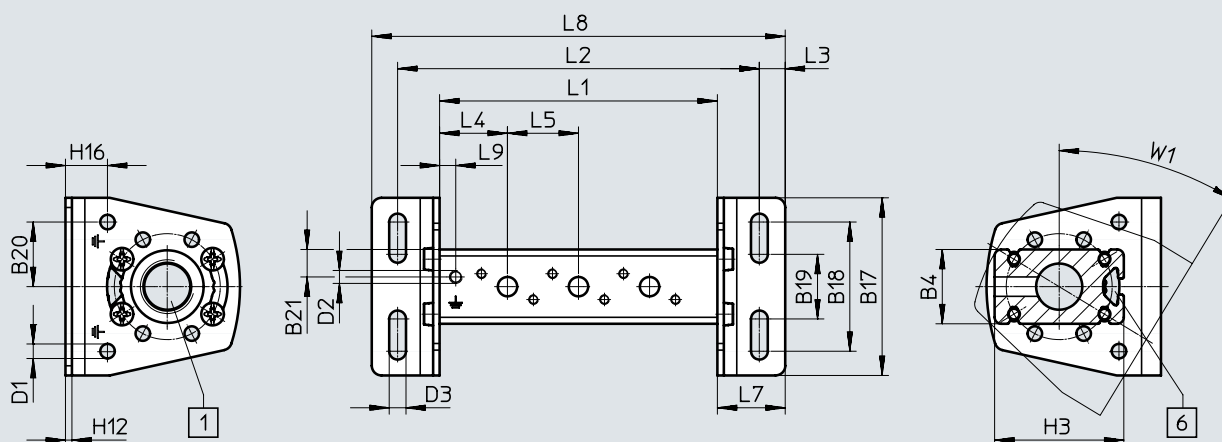

[1] Port 1: (at both ends): 3/8 NPT









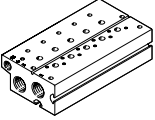

[6] Profile slot IPM-05, system 5

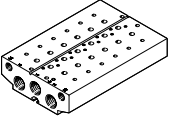
 **Note**
Mounting bracket can be adjusted through $\pm 30^\circ$

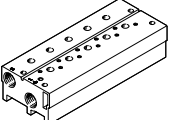

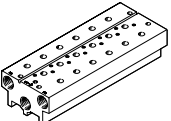

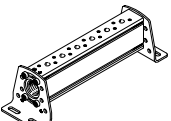

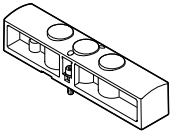
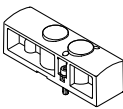

Type	B4	B17	B18	B19	B20	B21	D1 \varnothing	D2	D3 \varnothing	H3	H12	H16	L3	L4	L5	L7	L9	W1
VABM-B10-20-N38-...-P53	23	55	40	20	20	8.5	4.5	M4x6.5	5.2	40	2	13	9	21	22	22	5	31.3°

Valve positions	2	3	4	5	6	7	8	9	10
L1 [mm]	64	86	108	130	152	174	196	218	240
L2 [mm]	90	112	134	156	178	200	222	244	266
L8 [mm]	106	128	150	172	194	216	238	260	282

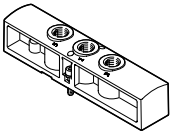
Ordering data – Manifold block, size 20

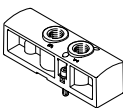
Ordering data		Valve positions	Part no.	Type
Description				
Standard manifold block				
 <p>For 3/2-way valves, including seals and screws for mounting valves</p> <p> Note Blanking plugs for sealing the supply ports (1, 3 and 14) at one end are included in the scope of delivery.</p>		2	576453	VABM-B10-20E-N38-2-P3
		3	576454	VABM-B10-20E-N38-3-P3
		4	576455	VABM-B10-20E-N38-4-P3
		5	576456	VABM-B10-20E-N38-5-P3
		6	576457	VABM-B10-20E-N38-6-P3
		7	576458	VABM-B10-20E-N38-7-P3
		8	576459	VABM-B10-20E-N38-8-P3
		9	576460	VABM-B10-20E-N38-9-P3
		10	576461	VABM-B10-20E-N38-10-P3
	 <p>For 5/2 and 5/3-way valves, including seals and screws for mounting valves</p> <p> Note Blanking plugs for sealing the supply ports (1, 3, 5, 12 and 14) at one end are included in the scope of delivery.</p>		2	576351
		3	576352	VABM-B10-20E-N38-3
		4	576353	VABM-B10-20E-N38-4
		5	576354	VABM-B10-20E-N38-5
		6	576355	VABM-B10-20E-N38-6
		7	576356	VABM-B10-20E-N38-7
		8	576357	VABM-B10-20E-N38-8
		9	576358	VABM-B10-20E-N38-9
		10	576359	VABM-B10-20E-N38-10
Compact manifold block				
 <p>For 3/2-way valves, including seals and screws for mounting valves</p> <p> Note Blanking plugs for sealing the supply ports (1 and 3) at one end are included in the scope of delivery.</p>		2	576477	VABM-B10-20S-N14-2-P3
		3	576478	VABM-B10-20S-N14-3-P3
		4	576479	VABM-B10-20S-N14-4-P3
		5	576480	VABM-B10-20S-N14-5-P3
		6	576481	VABM-B10-20S-N14-6-P3
		7	576482	VABM-B10-20S-N14-7-P3
		8	576483	VABM-B10-20S-N14-8-P3
		9	576484	VABM-B10-20S-N14-9-P3
		10	576485	VABM-B10-20S-N14-10-P3
	 <p>For 5/2 and 5/3-way valves, including seals and screws for mounting valves</p> <p> Note Blanking plugs for sealing the supply ports (1, 3 and 5) at one end are included in the scope of delivery.</p>		2	576429
		3	576430	VABM-B10-20S-N14-3
		4	576431	VABM-B10-20S-N14-4
		5	576432	VABM-B10-20S-N14-5
		6	576433	VABM-B10-20S-N14-6
		7	576434	VABM-B10-20S-N14-7
		8	576435	VABM-B10-20S-N14-8
		9	576436	VABM-B10-20S-N14-9
		10	576437	VABM-B10-20S-N14-10
Common supply manifold				
 <p>For mounting on both sides, including seals and screws for valve mounting</p> <p> Note Blanking plug for sealing the supply port (1) at one end included in the scope of delivery.</p>		2	576375	VABM-B10-20-N38-2-P53
		3	576376	VABM-B10-20-N38-3-P53
		4	576377	VABM-B10-20-N38-4-P53
		5	576378	VABM-B10-20-N38-5-P53
		6	576379	VABM-B10-20-N38-6-P53
		7	576380	VABM-B10-20-N38-7-P53
		8	576381	VABM-B10-20-N38-8-P53
		9	576382	VABM-B10-20-N38-9-P53
		10	576383	VABM-B10-20-N38-10-P53

Accessories – Manifold block, size 20

Ordering data		Weight [g]	Part no.	Type
Description				
Blanking plate				
	For valve position on manifold block for 5/2-, 5/3-way valves	78	576410	VABB-B10-20-E
	For valve position on manifold block for 3/2-way valves	56	576411	VABB-B10-20-E-P3
	For valve position on common supply manifold	13	576409	VABB-B10-20-A
Supply plate				
	For valve position on manifold block for 5/2-, 5/3-way valves -  - Note Supply plates and air supply plates are available with G thread only.	78	576492	VABF-B10-20-P1A4-G18
	For valve position on manifold block for 3/2-way valves -  - Note Supply plates and air supply plates are available with G thread only.	56	576493	VABF-B10-20-P1A4-G18-P3
Air supply plate				
	For valve position on common supply manifold -  - Note Supply plates and air supply plates are available with G thread only.	13	576491	VABF-B10-20-P1-G18





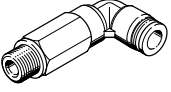

Ordering data		Description of NPT thread	Part no.	Type	PU ¹⁾
Push-in fitting with internal hex					
	Connecting thread 1/8 NPT for tubing O.D.	5/32 "	572317	QB-1/8-5/32-I-U	10
		1/4 "	572318	QB-1/8-1/4-I-U	10
		5/16 "	572319	QB-1/8-5/16-I-U	10
	Connecting thread 1/4 NPT for tubing O.D.	5/16 "	572321	QB-1/4-5/16-I-U	10
		3/8 "	572322	QB-1/4-3/8-I-U	10
		1/2 "	567771	QB-1/4-1/2-U	10
	Connecting thread 3/8 NPT for tubing O.D.	5/16 "	572323	QB-3/8-5/16-I-U	10
		3/8 "	572324	QB-3/8-3/8-I-U	10
		1/2 "	572325	QB-3/8-1/2-I-U	10

1) Packaging unit

Accessories – Manifold block, size 20

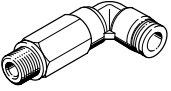

Ordering data		Description of NPT thread	Part no.	Type	PJ ¹⁾
Angled push-in fitting with external hex					
	Connecting thread 1/8 NPT for tubing O.D.	5/32 "	533290	QBL-1/8-5/32-U	10
		1/4 "	533292	QBL-1/8-1/4-U	10
		5/16 "	533293	QBL-1/8-5/16-U	10
	Connecting thread 1/4 NPT for tubing O.D.	5/16 "	533296	QBL-1/4-5/16-U	10
		3/8 "	533297	QBL-1/4-3/8-U	5
		1/2 "	567775	QBL-1/4-1/2-U	5
	Connecting thread 3/8 NPT for tubing O.D.	5/16 "	533299	QBL-3/8-5/16-U	5
		3/8 "	533300	QBL-3/8-3/8-U	5
		1/2 "	533301	QBL-3/8-1/2-U	5
Angled push-in fitting, long, with external hex					
	Connecting thread 1/8 NPT for tubing O.D.	5/32 "	564668	QBLL-1/8-5/32-U	10
		1/4 "	564670	QBLL-1/8-1/4-U	10
		5/16 "	564671	QBLL-1/8-5/16-U	10

1) Packaging unit





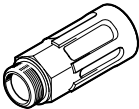

Ordering data		Description of G thread	Part no.	Type	PJ ¹⁾
Push-in fitting with internal hex					
	 Note Push-in fittings with G thread are for supply plates and air supply plates only.	4 mm	186106	QS-G1/8-4-I	10
			133008	QS-G1/8-4-1-100	100
		6 mm	186107	QS-G1/8-6-I	10
			133009	QS-G1/8-6-1-100	100
		8 mm	186109	QS-G1/8-8-I	10
			133010	QS-G1/8-8-1-100	100
Angled push-in fitting with external hex					
	 Note Push-in fittings with G thread are for supply plates and air supply plates only.	4 mm	186116	QSL-G1/8-4	10
			132048	QSL-G1/8-4-100	100
		6 mm	186117	QSL-G1/8-6	10
			132049	QSL-G1/8-6-100	100
		8 mm	186119	QSL-G1/8-8	10
			132050	QSL-G1/8-8-50	50
Angled push-in fitting, long, with external hex					
	 Note Push-in fittings with G thread are for supply plates and air supply plates only.	4 mm	186127	QSLG-G1/8-4	10
			133015	QSLG-G1/8-4-100	100
		6 mm	186128	QSLG-G1/8-6	10
			133016	QSLG-G1/8-6-100	100
		8 mm	186130	QSLG-G1/8-8	10
			133017	QSLG-G1/8-8-100	100

1) Packaging unit

Accessories – Manifold block, size 20

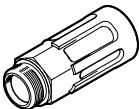

Ordering data		Description of NPT thread	Part no.	Type	PU ¹⁾
Silencer					
	With connecting thread NPT, metal design	1/4 NPT	12639	U-1/4-B-NPT	1
		3/8 NPT	12740	U-3/8-B-NPT	1
	With connecting thread NPT, sintered design, long	1/4 NPT	1206990	AMTE-M-LH-N14	20
		3/8 NPT	1206991	AMTE-M-LH-N38	10

1) Packaging unit

Ordering data		Description of G thread	Part no.	Type	PU ¹⁾
Silencer					
	With connecting thread G, polymer design -  - Note Silencers with G thread are for supply plates and air supply plates only.	G1/8	2307	U-1/8	1
			534222	U-1/8-50	50
	With connecting thread G, metal design -  - Note Silencers with G thread are for supply plates and air supply plates only.	G1/8	6841	U-1/8-B	1
	With connecting thread G, sintered design, long -  - Note Silencers with G thread are for supply plates and air supply plates only.	G1/8	1205860	AMTE-M-LH-G18	20

1) Packaging unit

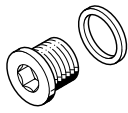
Accessories – Manifold block, size 20

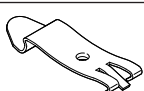
Ordering data		Description	Part no.	Type	PU ¹⁾
Blanking plug					
	With connecting thread NPT	1/8 NPT	173985	B-1/8-NPT	1
		1/4 NPT	174165	B-1/4-NPT	1
		3/8 NPT	174169	B-3/8-NPT	1
Separator					
	For creating pressure zones for port	G1/8	569995	VABD-8-B	1
		1/8 NPT			
		G1/4	569996	VABD-10-B	1
		1/4 NPT			
		G3/8	574483	VABD-14-B	1
		3/8 NPT			
H-rail mounting					
	For size 20, for mounting on standard H-rails TH 35-7.5 or TH 35-15 to EN 60715		569998	VAME-T-M4	2

1) Packaging unit

Data sheet – Manifold block, size 25

-  - Flow rate
up to 1300 l/min

-  - Valve width
26.5 mm



General technical data

For valves	Manifold block standard		Manifold block compact		Common supply manifold on both sides
	3/2	5/2, 5/3	3/2	5/2, 5/3	3/2, 5/2, 5/3
Grid dimension [mm]	27.5				
Type of mounting	With through-hole				With mounting bracket
Maximum number of valve positions	10	10	10	10	10
Port 1	1/2 NPT	1/2 NPT	3/8 NPT	3/8 NPT	1/2 NPT
Port 3	1/2 NPT	1/2 NPT	3/8 NPT	3/8 NPT	-
Port 5	-	1/2 NPT	-	3/8 NPT	-
Port 12	1/8 NPT	1/8 NPT	-	-	-
Port 14	-	1/8 NPT	-	-	-
CRC ¹⁾	2 ¹⁾				

1) More information: www.festo.com/x/topic/kbk

Weight [g]

Valve positions	2	3	4	5	6	7	8	9	10
Manifold block for 3/2-way valves, standard									
VABM-B10-25E-N12-...-P3	726	960	1194	1428	1662	1896	2130	2364	2598
Manifold block for 5/2- and 5/3-way valves, standard									
VABM-B10-25E-N12-...	927	1224	1521	1818	2115	2412	2709	3006	3303
Manifold block for 3/2-way valves, compact									
VABM-B10-25S-N38-...-P3	369	488	607	726	845	964	1083	1202	1321
Manifold block for 5/2- and 5/3-way valves, compact									
VABM-B10-25S-N38-...	438	579	720	861	1002	1143	1284	1425	1566
Common supply manifold for mounting on both sides									
VABM-B10-25-N12-...-P53	258	340	422	504	586	668	750	832	914

Information on materials

Information on materials	Wrought aluminium alloy
Note on materials	RoHS-compliant

Data sheet – Manifold block, size 25

Dimensions

Manifold block for 3/2-way valves, standard

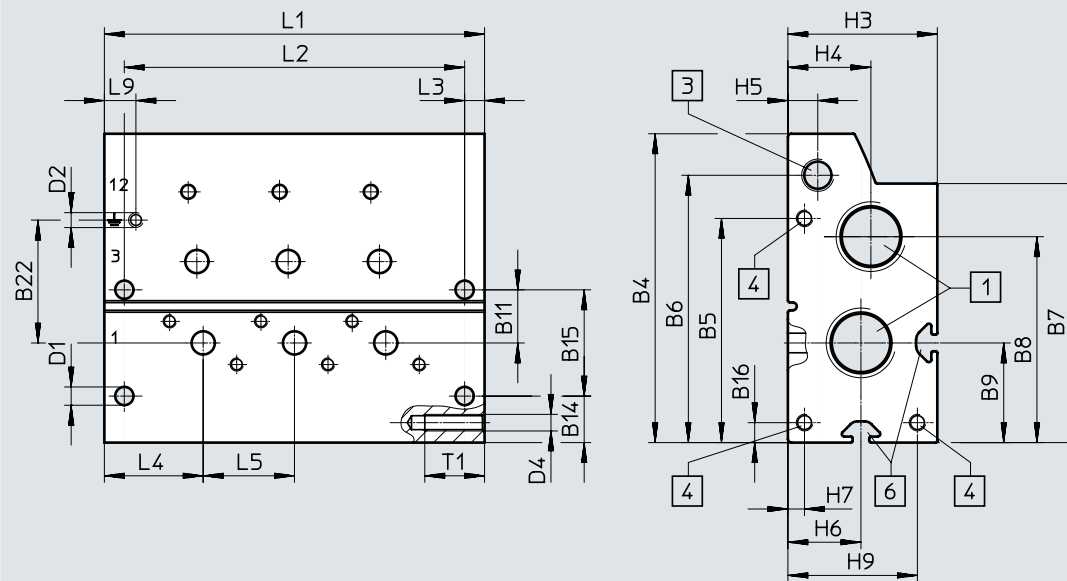

[1] Ports 1 and 3 (at both ends):
1/2 NPT

[3] Ports 12 (at both ends):
1/8 NPT

[4] Thread M5x18 for extension
module

[6] Profile slot IPM-05, system 5

Type	B4	B5	B6	B7	B8	B9	B11	B14	B15	B16	B22
VABM-B10-25-E-N12-...-P3	93	67.5	80.5	78	62	30	16	14	32	6	37

Type	D1 ø	D2	D4	H3	H4	H5	H6	H7	H9	L3	L4	L5	L9	T1
VABM-B10-25-E-N12-...-P3	5.5	M4x9	M5	45	25	9	22	5	39	6	29.8	27.5	9.5	18

Valve positions	2	3	4	5	6	7	8	9	10
L1 [mm]	87	114.5	142	169.5	197	224.5	252	279.5	307
L2 [mm]	75	102.5	130	157.5	185	212.5	240	267.5	295

Data sheet – Manifold block, size 25

Dimensions

Manifold block for 5/2- and 5/3-way valves, standard

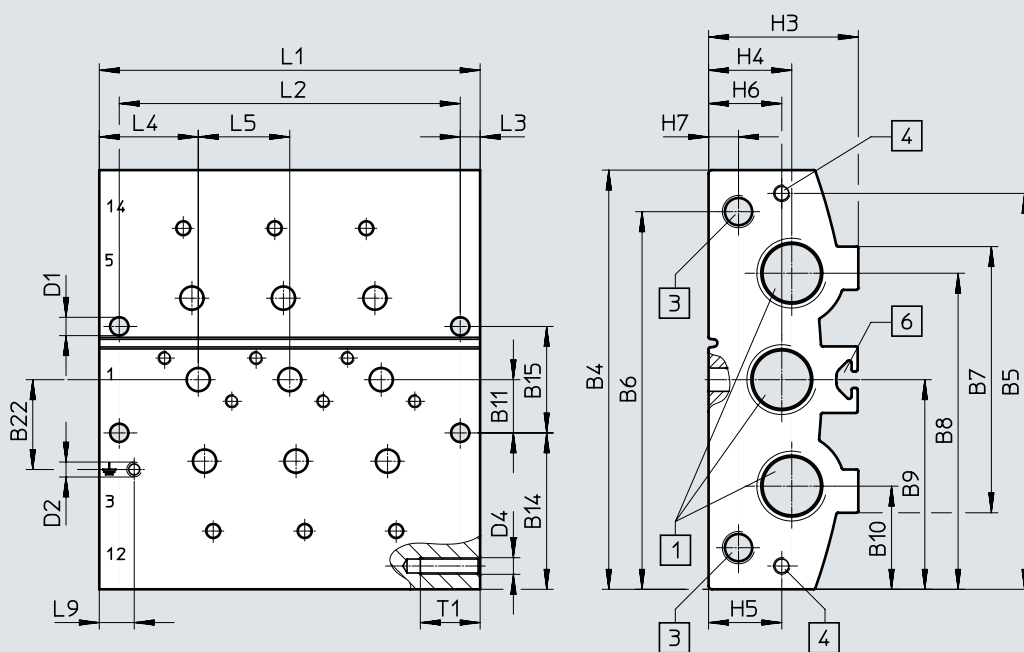

[1] Ports 1, 3 and 5 (at both ends):
1/2 NPT

[3] Ports 12 and 14 (at both ends):
1/8 NPT

[4] Thread M5x18 for extension
module

[6] Profile slot IPM-05, system 5

Type	B4	B5	B6	B7	B8	B9	B10	B11	B14	B15	B22
VABM-B10-25E-N12-...	126	119	113.5	80	95	63	31	16	47	32	27

Type	D1 \varnothing	D2	D4	H3	H4	H5	H6	H7	L3	L4	L5	L9	T1
VABM-B10-25E-N12-...	5.5	M4x9	M5	45	25	22	22	9	6	29.8	27.5	10.5	18

Valve positions	2	3	4	5	6	7	8	9	10
L1 [mm]	87	114.5	142	169.5	197	224.5	252	279.5	307
L2 [mm]	75	102.5	130	157.5	185	212.5	240	267.5	295

Data sheet – Manifold block, size 25

Dimensions

Manifold block for 3/2-way valves, compact

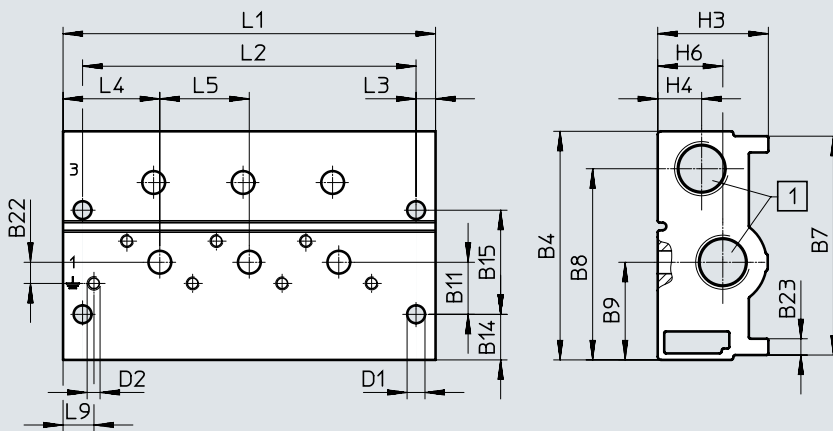

[1] Ports 1 and 3 (at both ends):
3/8 NPT

Type	B4	B7	B8	B9	B11	B14	B15	B22	B23
VABM-B10-25S-N38-...-P3	70.3	67.3	58.8	30	16	14	32	6.5	5

Type	D1 ø	D2	H3	H4	H6	L3	L4	L5	L9
VABM-B10-25S-N38-...-P3	5.5	M4x9	34	13.5	20	6	29.8	27.5	9.5

Valve positions	2	3	4	5	6	7	8	9	10
L1 [mm]	87	114.5	142	169.5	197	224.5	252	279.5	307
L2 [mm]	75	102.5	130	157.5	185	212.5	240	267.5	295

Data sheet – Manifold block, size 25

Dimensions

Manifold block for 5/2- and 5/3-way valves, compact

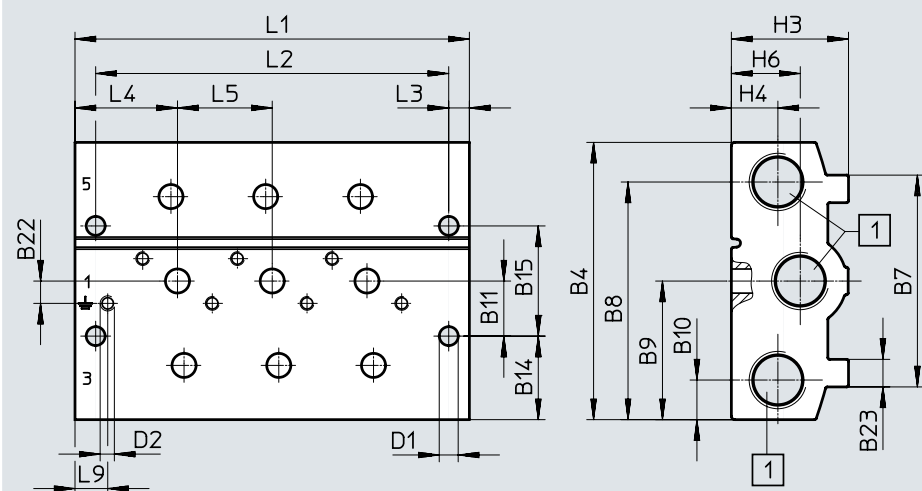

[1] Ports 1, 3 and 5 (at both ends):
3/8 NPT

Type	B4	B7	B8	B9	B10	B11	B14	B15	B22	B23
VABM-B10-25S-N38-...	80.5	61.5	69	40.3	11.5	16	24.3	32	6.5	8

Type	D1 ø	D2	H3	H4	H6	L3	L4	L5	L9
VABM-B10-25S-N38-...	5.5	M4x9	34	13.5	20	6	29.8	27.5	9.5

Valve positions	2	3	4	5	6	7	8	9	10
L1 [mm]	87	114.5	142	169.5	197	224.5	252	279.5	307
L2 [mm]	75	102.5	130	157.5	185	212.5	240	267.5	295

Data sheet – Manifold block, size 25

Dimensions

Common supply manifold, mounting on both sides

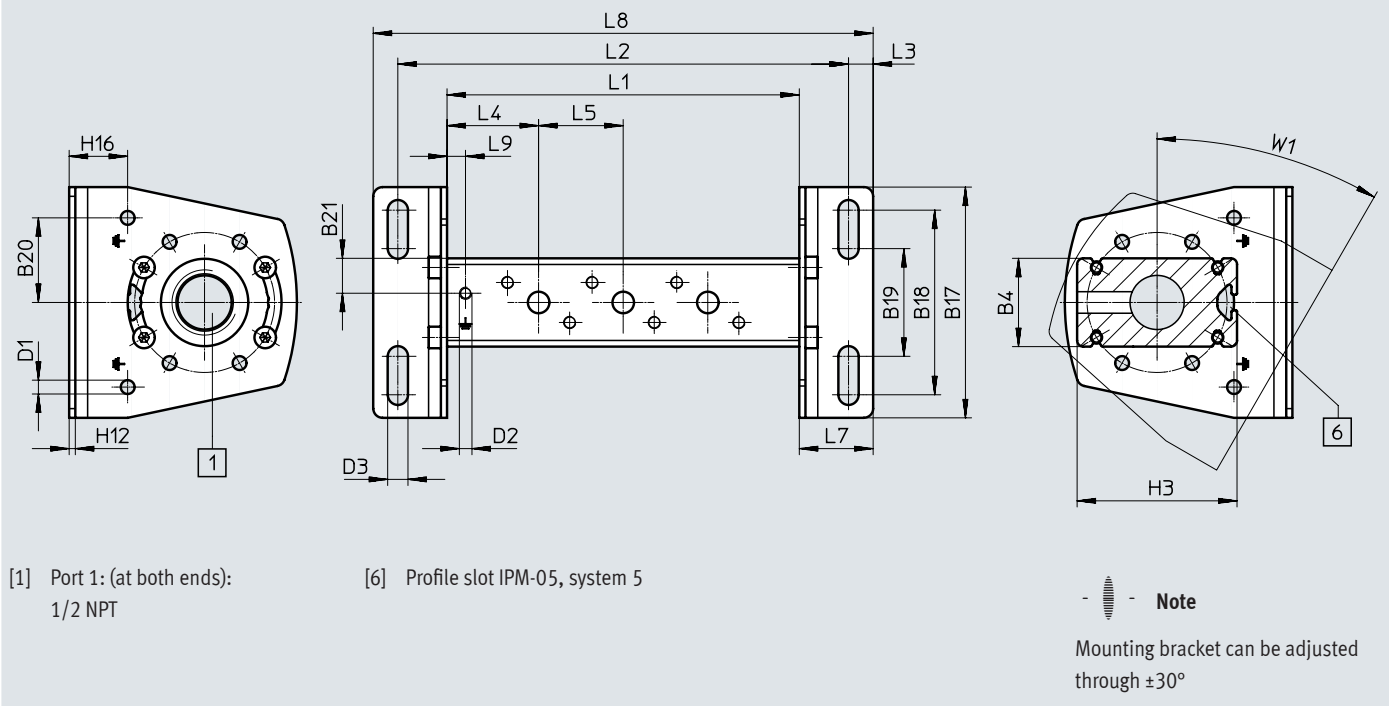







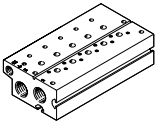
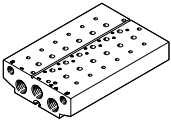
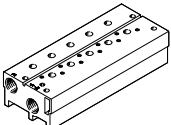
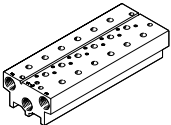
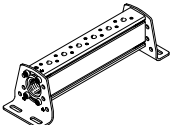

Type	B4	B17	B18	B19	B20	B21	D1 \varnothing	D2	D3 \varnothing	H3	H12	H16	L3	L4	L5	L7	L9	W1
VABM-B10-25-N12-...-P53	28.7	75	60	35	27.5	11.4	4.5	M4x9	6.6	52	2	19	8	29.8	27.5	24	6	30

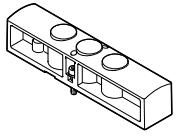
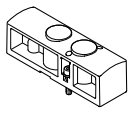
Valve positions	2	3	4	5	6	7	8	9	10
L1 [mm]	87	114.5	142	169.5	197	224.5	252	279.5	307
L2 [mm]	119	146.5	174	201.5	229	256.5	284	311.5	339
L8 [mm]	135	162.5	190	217.5	245	272.5	300	327.5	355

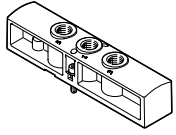

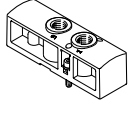
Ordering data – Manifold block, size 25

Ordering data		Valve positions	Part no.	Type
Description				
Standard manifold block				
 <p>For 3/2-way valves, including seals and screws for mounting valves</p> <p>Note Blanking plugs for sealing the supply ports (1, 3 and 14) on one side are included in the scope of delivery</p>	2	8026288	VABM-B10-25E-N12-2-P3	
	3	8026289	VABM-B10-25E-N12-3-P3	
	4	8026290	VABM-B10-25E-N12-4-P3	
	5	8026291	VABM-B10-25E-N12-5-P3	
	6	8026292	VABM-B10-25E-N12-6-P3	
	7	8026293	VABM-B10-25E-N12-7-P3	
	8	8026294	VABM-B10-25E-N12-8-P3	
	9	8026295	VABM-B10-25E-N12-9-P3	
	10	8026296	VABM-B10-25E-N12-10-P3	
	 <p>For 5/2 and 5/3-way valves, including seals and screws for mounting valves</p> <p>Note Blanking plugs for sealing the supply ports (1, 3, 5, 12 and 14) at one end are included in the scope of delivery.</p>	2	8026252	VABM-B10-25E-N12-2
3		8026253	VABM-B10-25E-N12-3	
4		8026254	VABM-B10-25E-N12-4	
5		8026255	VABM-B10-25E-N12-5	
6		8026256	VABM-B10-25E-N12-6	
7		8026257	VABM-B10-25E-N12-7	
8		8026258	VABM-B10-25E-N12-8	
9		8026259	VABM-B10-25E-N12-9	
10		8026260	VABM-B10-25E-N12-10	
Compact manifold block				
 <p>For 3/2-way valves, including seals and screws for mounting valves</p> <p>Note Blanking plugs for sealing the supply ports (1 and 3) at one end are included in the scope of delivery.</p>	2	8026306	VABM-B10-25S-N38-2-P3	
	3	8026307	VABM-B10-25S-N38-3-P3	
	4	8026308	VABM-B10-25S-N38-4-P3	
	5	8026309	VABM-B10-25S-N38-5-P3	
	6	8026310	VABM-B10-25S-N38-6-P3	
	7	8026311	VABM-B10-25S-N38-7-P3	
	8	8026312	VABM-B10-25S-N38-8-P3	
	9	8026313	VABM-B10-25S-N38-9-P3	
	10	8026314	VABM-B10-25S-N38-10-P3	
	 <p>For 5/2 and 5/3-way valves, including seals and screws for mounting valves</p> <p>Note Blanking plugs for sealing the supply ports (1, 3 and 5) at one end are included in the scope of delivery.</p>	2	8026270	VABM-B10-25S-N38-2
3		8026271	VABM-B10-25S-N38-3	
4		8026272	VABM-B10-25S-N38-4	
5		8026273	VABM-B10-25S-N38-5	
6		8026274	VABM-B10-25S-N38-6	
7		8026275	VABM-B10-25S-N38-7	
8		8026276	VABM-B10-25S-N38-8	
9		8026277	VABM-B10-25S-N38-9	
10		8026278	VABM-B10-25S-N38-10	
Common supply manifold				
 <p>For mounting on both sides, including seals and screws for valve mounting</p> <p>Note Blanking plug for sealing the supply port (1) at one end included in the scope of delivery.</p>	2	8026228	VABM-B10-25-N12-2-P53	
	3	8026229	VABM-B10-25-N12-3-P53	
	4	8026230	VABM-B10-25-N12-4-P53	
	5	8026231	VABM-B10-25-N12-5-P53	
	6	8026232	VABM-B10-25-N12-6-P53	
	7	8026233	VABM-B10-25-N12-7-P53	
	8	8026234	VABM-B10-25-N12-8-P53	
	9	8026235	VABM-B10-25-N12-9-P53	
	10	8026236	VABM-B10-25-N12-10-P53	





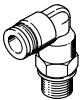

Accessories – Manifold block, size 25

Ordering data		Weight [g]	Part no.	Type
Description				
Blanking plate				
	For valve position on manifold block for 5/2-, 5/3-way valves	117	8026209	VABB-B10-25-E
	For valve position on manifold block for 3/2-way valves	84	8026210	VABB-B10-25-E-P3
	For valve position on common supply manifold	28	8026208	VABB-B10-25-A
Supply plate				
	For valve position on manifold block for 3/2-way valves  - Note Supply plates and air supply plates are available with G thread only.	80	8026319	VABF-B10-25-P1A4-G14-P3
	For valve position on manifold block for 5/2-, 5/3-way valves  - Note Supply plates and air supply plates are available with G thread only.	110	8026318	VABF-B10-25-P1A4-G14
Air supply plate				
	For valve position on common supply manifold  - Note Supply plates and air supply plates are available with G thread only.	26	8026317	VABF-B10-25-P1-G14

Accessories – Manifold block, size 25

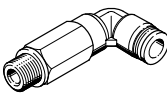

Ordering data		Description of NPT thread	Part no.	Type	PU ¹⁾
Push-in fitting with internal hex					
	Connecting thread 1/8 NPT for tubing O.D.	1/4 "	572318	QB-1/8-1/4-I-U	10
	Connecting thread 3/8 NPT for tubing O.D.	5/16 "	572323	QB-3/8-5/16-I-U	10
		3/8 "	572324	QB-3/8-3/8-I-U	10
		1/2 "	572325	QB-3/8-1/2-I-U	10
	Connecting thread 1/2 NPT for tubing O.D.	1/2 "	572326	QB-1/2-1/2-I-U	10
Push-in fitting with external hex					
	Connecting thread 1/2 NPT for tubing O.D.	3/8 "	533283	QB-1/2-3/8-U	5
Angled push-in fitting with external hex					
	Connecting thread 3/8 NPT for tubing O.D.	5/16 "	533299	QBL-3/8-5/16-U	5
		3/8 "	533300	QBL-3/8-3/8-U	5
		1/2 "	533301	QBL-3/8-1/2-U	5
	Connecting thread 1/2 NPT for tubing O.D.	3/8 "	533302	QBL-1/2-3/8-U	5
		1/2 "	533303	QBL-1/2-1/2-U	5

1) Packaging unit





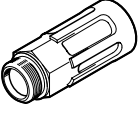

Ordering data		Description of G thread	Part no.	Type	PU ¹⁾	
Push-in fitting with internal hex						
	 - Note Push-in fittings with G thread are for supply plates and air supply plates only.	Connecting thread G1/4 for tubing O.D.	6 mm	186108	QS-G1/4-6-I	10
		8 mm	186110	QS-G1/4-8-I	10	
		10 mm	186112	QS-G1/4-10-I	10	
Angled push-in fitting with external hex						
	 - Note Push-in fittings with G thread are for supply plates and air supply plates only.	Connecting thread G1/4 for tubing O.D.	6 mm	186118	QSL-G1/4-6	10
			132051	QSL-G1/4-6-100	100	
		8 mm	186120	QSL-G1/4-8	10	
			132052	QSL-G1/4-8-50	50	
		10 mm	186122	QSL-G1/4-10	10	
			132053	QSL-G1/4-10-50	50	
Angled push-in fitting, long, with external hex						
	 - Note Push-in fittings with G thread are for supply plates and air supply plates only.	Connecting thread G1/4 for tubing O.D.	6 mm	186129	QSL-G1/4-6	10
			8 mm	186131	QSL-G1/4-8	10
			10 mm	186133	QSL-G1/4-10	10

1) Packaging unit

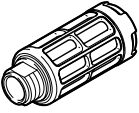
Accessories – Manifold block, size 25

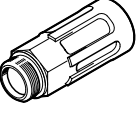

Ordering data		Description of NPT thread	Part no.	Type	PU ¹⁾
Silencer					
	With connecting thread NPT, metal design	3/8 NPT	12740	U-3/8-B-NPT	1
		1/2 NPT	12741	U-1/2-B-NPT	1
	With connecting thread NPT, sintered design, long	3/8 NPT	1206991	AMTE-M-LH-N38	10
		1/2 NPT	1206992	AMTE-M-LH-N12	10

1) Packaging unit

Ordering data		Description of G thread	Part no.	Type	PU ¹⁾
Silencer					
	With connecting thread G, polymer design	G1/4	2316	U-1/4	1
			534223	U-1/4-20	20
 Note Silencers with G thread are for supply plates and air supply plates only.					
	With connecting thread G, metal design	G1/4	6842	U-1/4-B	1
			 Note Silencers with G thread are for supply plates and air supply plates only.		
	With connecting thread G, sintered design, long	G1/4	1205861	AMTE-M-LH-G14	20
			 Note Silencers with G thread are for supply plates and air supply plates only.		

1) Packaging unit

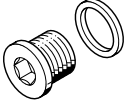
Accessories – Manifold block, size 25

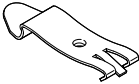
Ordering data	Description	Part no.	Type	PU ¹⁾	
Blanking plug					
	With connecting thread NPT	1/8 NPT	173985	B-1/8-NPT	1
		3/8 NPT	174169	B-3/8-NPT	1
		1/2 NPT	31785	B-1/2-NPT	1
Separator					
	For creating pressure zones for port	G1/8 1/8 NPT	569995	VABD-8-B	1
		G3/8 3/8 NPT	574483	VABD-14-B	1
		G1/2 1/2 NPT	8022483	VABD-17.5-B	1
H-rail mounting					
	For size 25, for mounting on standard H-rails TH 35-7.5 or TH 35-15 to EN 60715	2636436	VAME-T-M5	2	

1) Packaging unit

Data sheet – Manifold block, size 30

-  - Flow rate
up to 2300 l/min

-  - Valve width
31 mm



General technical data					
	Manifold block standard		Manifold block compact		Common supply manifold on both sides
For valves	3/2	5/2, 5/3	3/2	5/2, 5/3	3/2, 5/2, 5/3
Grid dimension [mm]	32				
Type of mounting	With through-hole				With mounting bracket
Maximum number of valve positions	10	10	10	10	10
Port 1	3/4 NPT	3/4 NPT	1/2 NPT	1/2 NPT	3/4 NPT
Port 3	3/4 NPT	3/4 NPT	1/2 NPT	1/2 NPT	-
Port 5	-	3/4 NPT	-	1/2 NPT	-
Port 12	1/8 NPT	1/8 NPT	-	-	-
Port 14	-	1/8 NPT	-	-	-
CRC ¹⁾	2 ¹⁾				

1) More information: www.festo.com/x/topic/kbk

Weight [g]									
Valve positions	2	3	4	5	6	7	8	9	10
Manifold block for 3/2-way valves, standard									
VABM-B10-30E-N34-...-P3	1411	1828	2245	2662	3079	3496	3913	4330	4747
Manifold block for 5/2- and 5/3-way valves, standard									
VABM-B10-30E-N34-...	1722	2213	2703	3194	3684	4175	4665	5156	5646
Manifold block for 3/2-way valves, compact									
VABM-B10-30S-N12-...-P3	652	872	1093	1313	1533	1753	1973	2193	2413
Manifold block for 5/2- and 5/3-way valves, compact									
VABM-B10-30S-N12-...	759	1013	1267	1522	1776	2030	2285	2539	2793
Common supply manifold for mounting on both sides									
VABM-B10-30-N34-...-P53	818	977	1135	1293	1452	1610	1768	1927	2085

Information on materials	
Information on materials	Wrought aluminium alloy
Note on materials	RoHS-compliant

Data sheet – Manifold block, size 30

Dimensions

Manifold block for 3/2-way valves, standard

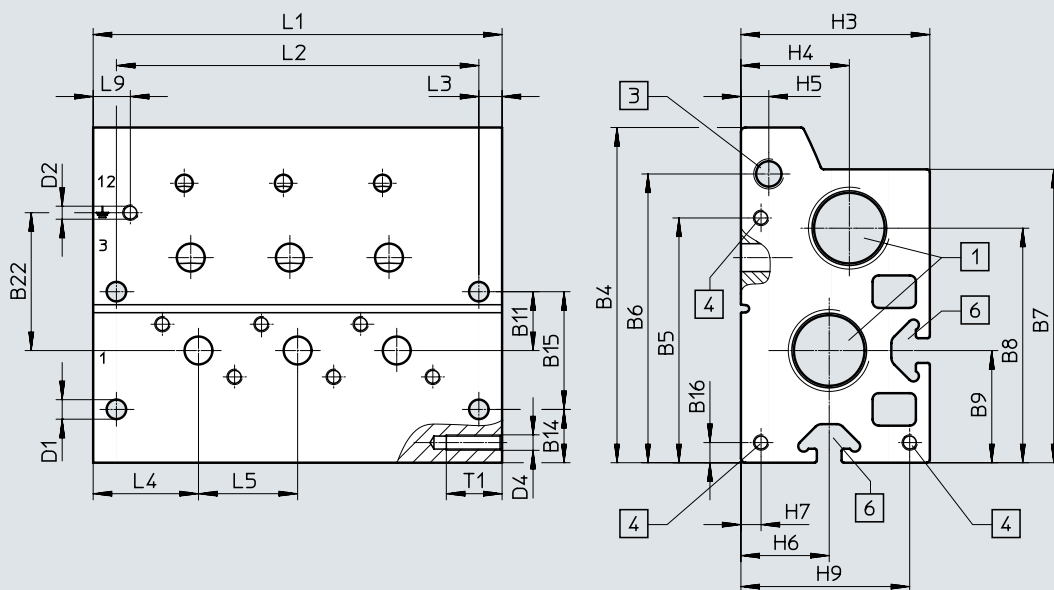

[1] Ports 1 and 3 (at both ends):
3/4 NPT

[3] Ports 12 (at both ends):
1/8 NPT

[4] Thread M5x18 for extension
module

[6] Profile slot IPM-08, system 8

Type	B4	B5	B6	B7	B8	B9	B11	B14	B15	B16	B22
VABM-B10-30-E-N34-...-P3	108.2	79	93.2	94.7	75.7	36.2	19	17.2	38	6.5	44.5

Type	D1 ø	D2	D4	H3	H4	H5	H6	H7	H9	L3	L4	L5	L9	T1
VABM-B10-30-E-N34-...-P3	6.3	M5x11	M5	61	35	9	28.5	6.5	54.5	7.5	34	32	12	18

Valve positions	2	3	4	5	6	7	8	9	10
L1 [mm]	100	132	164	196	228	260	292	324	356
L2 [mm]	85	117	149	181	213	245	277	309	341

Data sheet – Manifold block, size 30

Dimensions

Manifold block for 5/2- and 5/3-way valves, standard

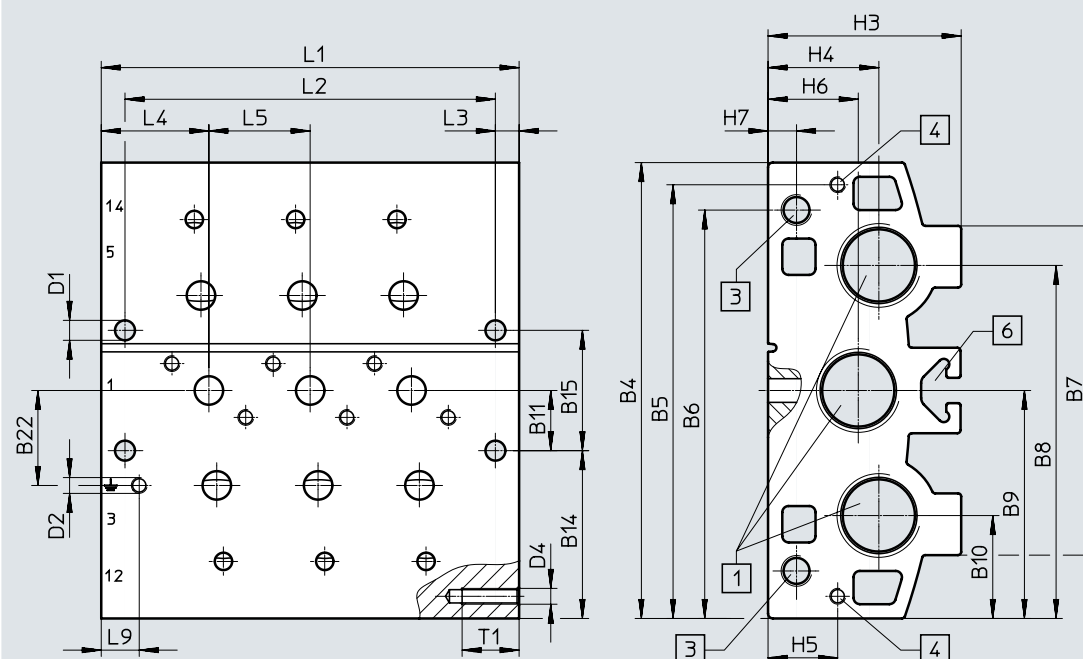

[1] Ports 1, 3 and 5 (at both ends):
3/4 NPT

[3] Ports 12 and 14 (at both ends):
1/8 NPT

[4] Thread M5x18 for extension
module

[6] Profile slot IPM-08, system 8

Type	B4	B5	B6	B7	B8	B9	B10	B11	B14	B15	B22
VABM-B10-30E-N34-...	144	137	129	104	111.5	72	32.5	19	53	38	30

Type	D1 ø	D2	D4	H3	H4	H5	H6	H7	L3	L4	L5	L9	T1
VABM-B10-30E-N34-...	6.3	M5*11	M5	61	35	22	28.5	9	7.5	34	32	12	18

Valve positions	2	3	4	5	6	7	8	9	10
L1 [mm]	100	132	164	196	228	260	292	324	356
L2 [mm]	85	117	149	181	213	245	277	309	341

Data sheet – Manifold block, size 30

Dimensions

Manifold block for 3/2-way valves, compact

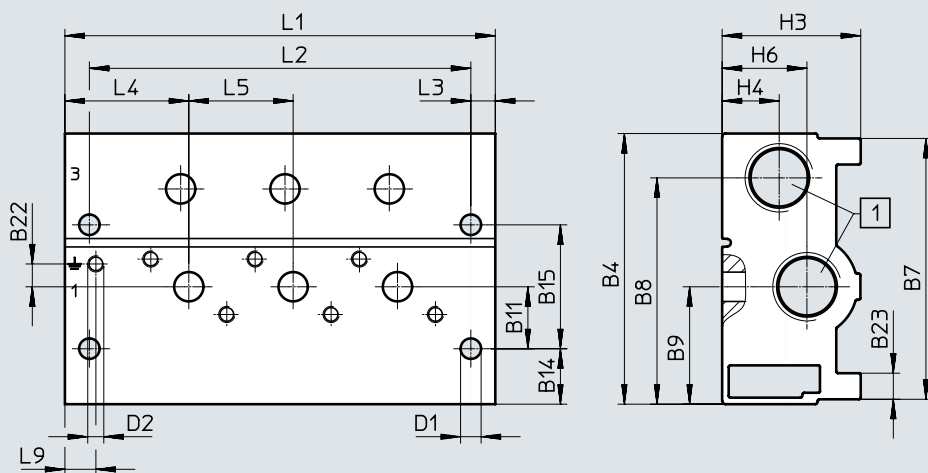

[1] Ports 1 and 3 (at both ends):
1/2 NPT

Type	B4	B7	B8	B9	B11	B14	B15	B22	B23
VABM-B10-30S-N12-...-P3	83	80	69.4	36	19	17	38	7	8

Type	D1 ø	D2	H3	H4	H6	L3	L4	L5	L9
VABM-B10-30S-N12-...-P3	6.3	M5x11	42.5	17.5	26	7.5	38	32	12

Valve positions	2	3	4	5	6	7	8	9	10
L1 [mm]	100	132	164	196	228	260	292	324	356
L2 [mm]	85	117	149	181	213	245	277	309	341

Data sheet – Manifold block, size 30

Dimensions

Manifold block for 5/2- and 5/3-way valves, compact

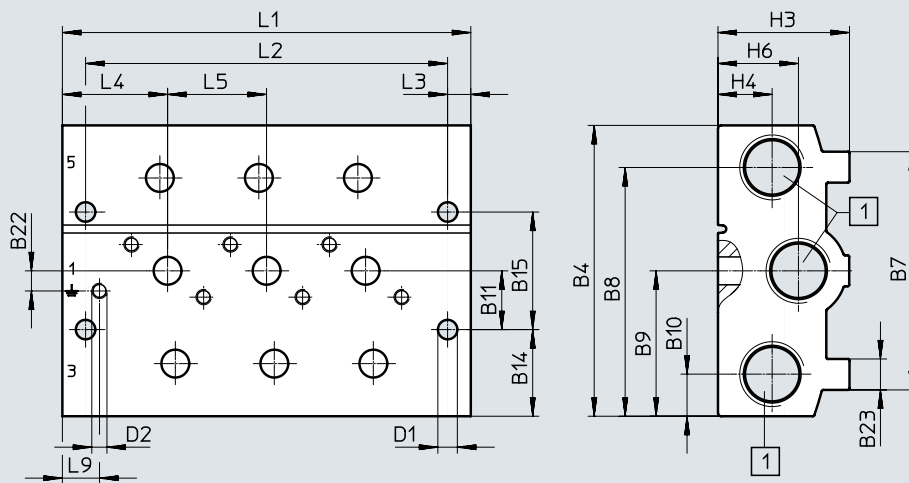

[1] Ports 1, 3 and 5 (at both ends):
1/2 NPT

Type	B4	B7	B8	B9	B10	B11	B14	B15	B22	B23
VABM-B10-30S-N12-...	94	77	80.4	47	13.6	19	28	38	6.5	10

Type	D1 \varnothing	D2	H3	H4	H6	L3	L4	L5	L9
VABM-B10-30S-N12-...	6.3	M5x11	42.5	17.5	26	7.5	34	32	12

Valve positions	2	3	4	5	6	7	8	9	10
L1 [mm]	100	132	164	196	228	260	292	324	356
L2 [mm]	85	117	149	181	213	245	277	309	341

Data sheet – Manifold block, size 30

Dimensions



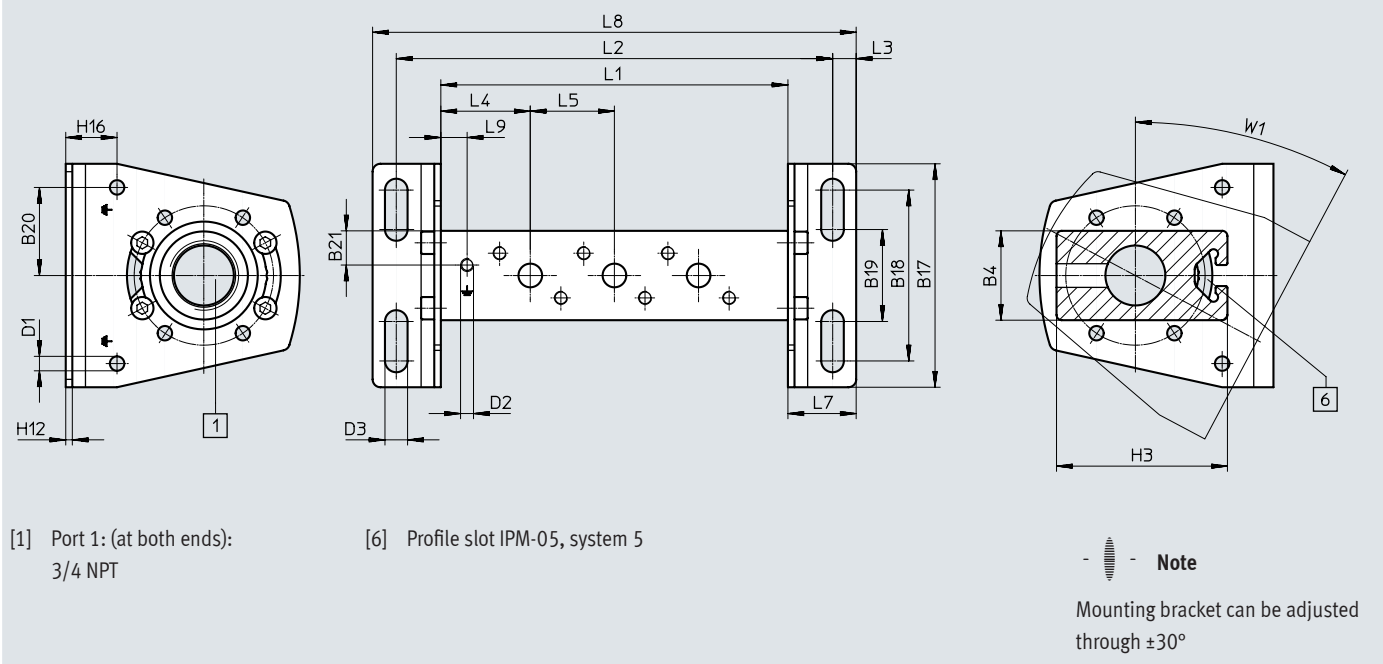





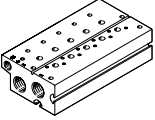

Common supply manifold, mounting on both sides

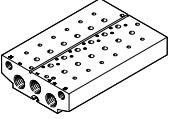

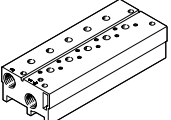

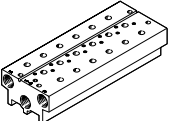

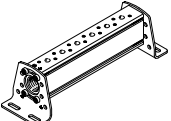
Type	B4	B17	B18	B19	B20	B21	D1 \varnothing	D2	D3 \varnothing	H3	H12	H16	L3	L4	L5	L7	L9	W1
VABM-B10-30-N34-...-P53	34	85	65	35	33.5	13	5.5	M5x11	8.6	65	2.5	19.5	9	34	32	26	10	28°

Valve positions	2	3	4	5	6	7	8	9	10
L1 [mm]	100	132	164	196	228	260	292	324	356
L2 [mm]	134	166	198	230	262	294	326	358	390
L8 [mm]	152	184	216	248	280	312	344	376	408



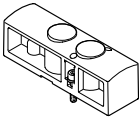
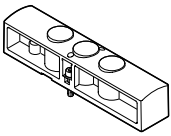

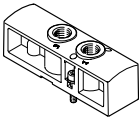
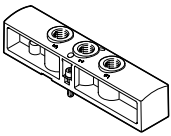
Ordering data – Manifold block, size 30

Ordering data		Valve positions	Part no.	Type
Description				
Standard manifold block				
 <p>For 3/2-way valves, including seals and screws for mounting valves</p> <p> Note Blanking plugs for sealing the supply ports (1, 3 and 14) at one end are included in the scope of delivery.</p>		2	8026404	VABM-B10-30E-N34-2-P3
		3	8026405	VABM-B10-30E-N34-3-P3
		4	8026406	VABM-B10-30E-N34-4-P3
		5	8026407	VABM-B10-30E-N34-5-P3
		6	8026408	VABM-B10-30E-N34-6-P3
		7	8026409	VABM-B10-30E-N34-7-P3
		8	8026410	VABM-B10-30E-N34-8-P3
		9	8026411	VABM-B10-30E-N34-9-P3
		10	8026412	VABM-B10-30E-N34-10-P3
	 <p>For 5/2 and 5/3-way valves, including seals and screws for mounting valves</p> <p> Note Blanking plugs for sealing the supply ports (1, 3, 5, 12 and 14) at one end are included in the scope of delivery.</p>		2	8026368
		3	8026369	VABM-B10-30E-N34-3
		4	8026370	VABM-B10-30E-N34-4
		5	8026371	VABM-B10-30E-N34-5
		6	8026372	VABM-B10-30E-N34-6
		7	8026373	VABM-B10-30E-N34-7
		8	8026374	VABM-B10-30E-N34-8
		9	8026375	VABM-B10-30E-N34-9
		10	8026376	VABM-B10-30E-N34-10
Compact manifold block				
 <p>For 3/2-way valves, including seals and screws for mounting valves</p> <p> Note Blanking plugs for sealing the supply ports (1 and 3) at one end are included in the scope of delivery.</p>		2	8026422	VABM-B10-30S-N12-2-P3
		3	8026423	VABM-B10-30S-N12-3-P3
		4	8026424	VABM-B10-30S-N12-4-P3
		5	8026425	VABM-B10-30S-N12-5-P3
		6	8026426	VABM-B10-30S-N12-6-P3
		7	8026427	VABM-B10-30S-N12-7-P3
		8	8026428	VABM-B10-30S-N12-8-P3
		9	8026429	VABM-B10-30S-N12-9-P3
		10	8026430	VABM-B10-30S-N12-10-P3
	 <p>For 5/2 and 5/3-way valves, including seals and screws for mounting valves</p> <p> Note Blanking plugs for sealing the supply ports (1, 3 and 5) at one end are included in the scope of delivery.</p>		2	8026386
		3	8026387	VABM-B10-30S-N12-3
		4	8026388	VABM-B10-30S-N12-4
		5	8026389	VABM-B10-30S-N12-5
		6	8026390	VABM-B10-30S-N12-6
		7	8026391	VABM-B10-30S-N12-7
		8	8026392	VABM-B10-30S-N12-8
		9	8026393	VABM-B10-30S-N12-9
		10	8026394	VABM-B10-30S-N12-10
Common supply manifold				
 <p>For mounting on both sides, including seals and screws for valve mounting</p> <p> Note Blanking plug for sealing the supply port (1) at one end included in the scope of delivery.</p>		2	8026347	VABM-B10-30-N34-2-P53
		3	8026348	VABM-B10-30-N34-3-P53
		4	8026349	VABM-B10-30-N34-4-P53
		5	8026350	VABM-B10-30-N34-5-P53
		6	8026351	VABM-B10-30-N34-6-P53
		7	8026352	VABM-B10-30-N34-7-P53
		8	8026353	VABM-B10-30-N34-8-P53
		9	8026354	VABM-B10-30-N34-9-P53
		10	8026355	VABM-B10-30-N34-10-P53







Accessories – Manifold block, size 30

Ordering data		Weight [g]	Part no.	Type
Description				
Blanking plate				
	For valve position on manifold block for 3/2-way valves	128	8026336	VABB-B10-30-E-P3
	For valve position on manifold block for 5/2-, 5/3-way valves	179	8026335	VABB-B10-30-E
	For valve position on common supply manifold	43	8026334	VABB-B10-30-A
Supply plate				
	For valve position on manifold block for 3/2-way valves - - Note Supply plates and air supply plates are available with G thread only.	121	8026435	VABF-B10-30-P1A4-G38-P3
	For valve position on manifold block for 5/2-, 5/3-way valves - - Note Supply plates and air supply plates are available with G thread only.	167	8026434	VABF-B10-30-P1A4-G38
Air supply plate				
	For valve position on common supply manifold - - Note Supply plates and air supply plates are available with G thread only.	40	8026433	VABF-B10-30-P1-G38

Accessories – Manifold block, size 30

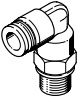

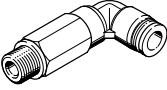
Ordering data		Description of NPT thread	Part no.	Type	PU ¹⁾
Push-in fitting with internal hex					
	Connecting thread 1/8 NPT for tubing O.D.	1/4 "	572318	QB-1/8-1/4-I-U	10
	Connecting thread 1/2 NPT for tubing O.D.	1/2 "	572326	QB-1/2-1/2-I-U	10
Push-in fitting with external hex					
	Connecting thread 1/2 NPT for tubing O.D.	3/8 "	533283	QB-1/2-3/8-U	5
Angled push-in fitting with external hex					
	Connecting thread 1/2 NPT for tubing O.D.	3/8 "	533302	QBL-1/2-3/8-U	5
		1/2 "	533303	QBL-1/2-1/2-U	5
Barbed fitting with external hex					
	Connecting thread 3/4 NPT for tubing I.D. Aluminium design	19 mm	564848	N-3/4-P-19-NPT	1

1) Packaging unit





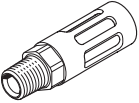

Ordering data		Description of G thread	Part no.	Type	PU ¹⁾
Push-in fitting with internal hex					
	 Note Push-in fittings with G thread are for supply plates and air supply plates only.	8 mm	186111	QS-G3/8-8-I	10
		10 mm	186113	QS-G3/8-10-I	10
		12 mm	186114	QS-G3/8-12-I	10
Angled push-in fitting with external hex					
	 Note Push-in fittings with G thread are for supply plates and air supply plates only.	8 mm	186121	QSL-G3/8-8	10
			132055	QSL-G3/8-8-50	50
		10 mm	186123	QSL-G3/8-10	10
			132056	QSL-G3/8-10-20	20
		12 mm	186124	QSL-G3/8-12	10
			132057	QSL-G3/8-12-20	20
Angled push-in fitting, long, with external hex					
	 Note Push-in fittings with G thread are for supply plates and air supply plates only.	8 mm	186132	QSL-G3/8-8	10
		10 mm	186134	QSL-G3/8-10	10
		12 mm	186135	QSL-G3/8-12	10

1) Packaging unit

Accessories – Manifold block, size 30

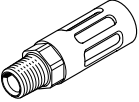

Ordering data		Description of NPT thread	Part no.	Type	PU ¹⁾
Silencer					
	With connecting thread NPT, metal design	1/2 NPT	12741	U-1/2-B-NPT	1
		3/4 NPT	566823	U-3/4-B-NPT	1
	With connecting thread NPT, sintered design, long	1/2 NPT	1206992	AMTE-M-LH-N1	10

1) Packaging unit

Ordering data		Description of G thread	Part no.	Type	PU ¹⁾
Silencer					
	With connecting thread G, polymer design	G3/8	534224	U-3/8-20	20
		 - Note Silencers with G thread are for supply plates and air supply plates only.			
	With connecting thread G, metal design	G3/8	6843	U-3/8-B	1
		 - Note Silencers with G thread are for supply plates and air supply plates only.			
	With connecting thread G, sintered design, long	G3/8	1205862	AMTE-M-LH-G38	10
 - Note Silencers with G thread are for supply plates and air supply plates only.					

1) Packaging unit

Accessories – Manifold block, size 30

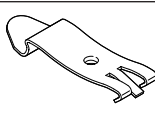
Ordering data		Description	Part no.	Type	PJ ¹⁾
Blanking plug					
	With connecting thread NPT	1/8 NPT	173985	B-1/8-NPT	1
		1/2 NPT	31785	B-1/2-NPT	1
		3/4 NPT	31786	B-3/4-NPT	1
Separator					
	For creating pressure zones for port	G1/8 1/8 NPT	569995	VABD-8-B	1
		G1/2 1/2 NPT	8022483	VABD-17.5-B	1
		G3/4 3/4 NPT	8022484	VABD-22.7-B	1
H-rail mounting					
	For size 30, for mounting on standard H-rails TH 35-7.5 or TH 35-15 to EN 60715		3488412	VAME-T-M6	2

1) Packaging unit