

Solenoid valves VUVG/valve manifold assembly VTUG-S

FESTO

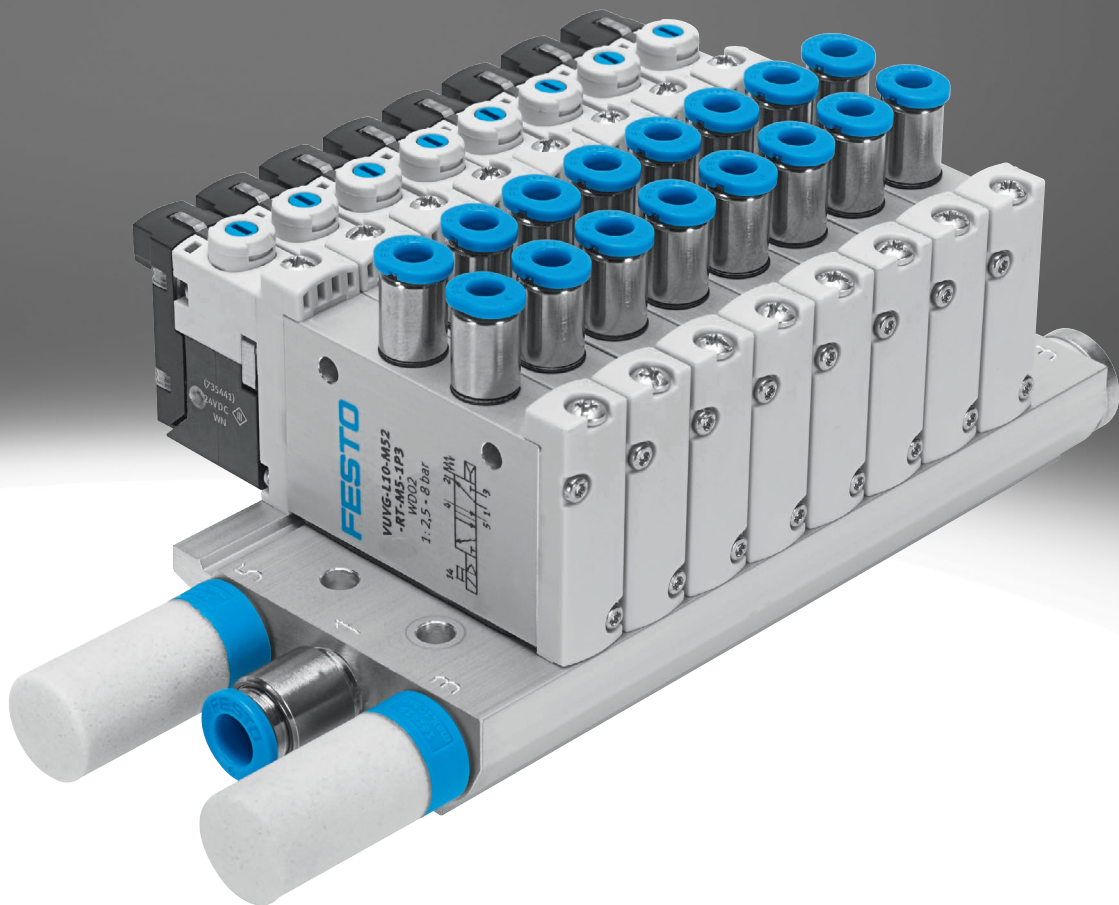

Festo Core Range
Solves the majority of your automation tasks

Worldwide:
Simply good:
Fast:

Quickest delivery – wherever, whenever
Expected high Festo quality
Easy and fast to select

With the Festo Core Range, we have selected the most important products and functions from our broad product catalogue, and added the quickest delivery.

The Core Range offers you the best value for your automation tasks.

Just look
for the
star!

Key features

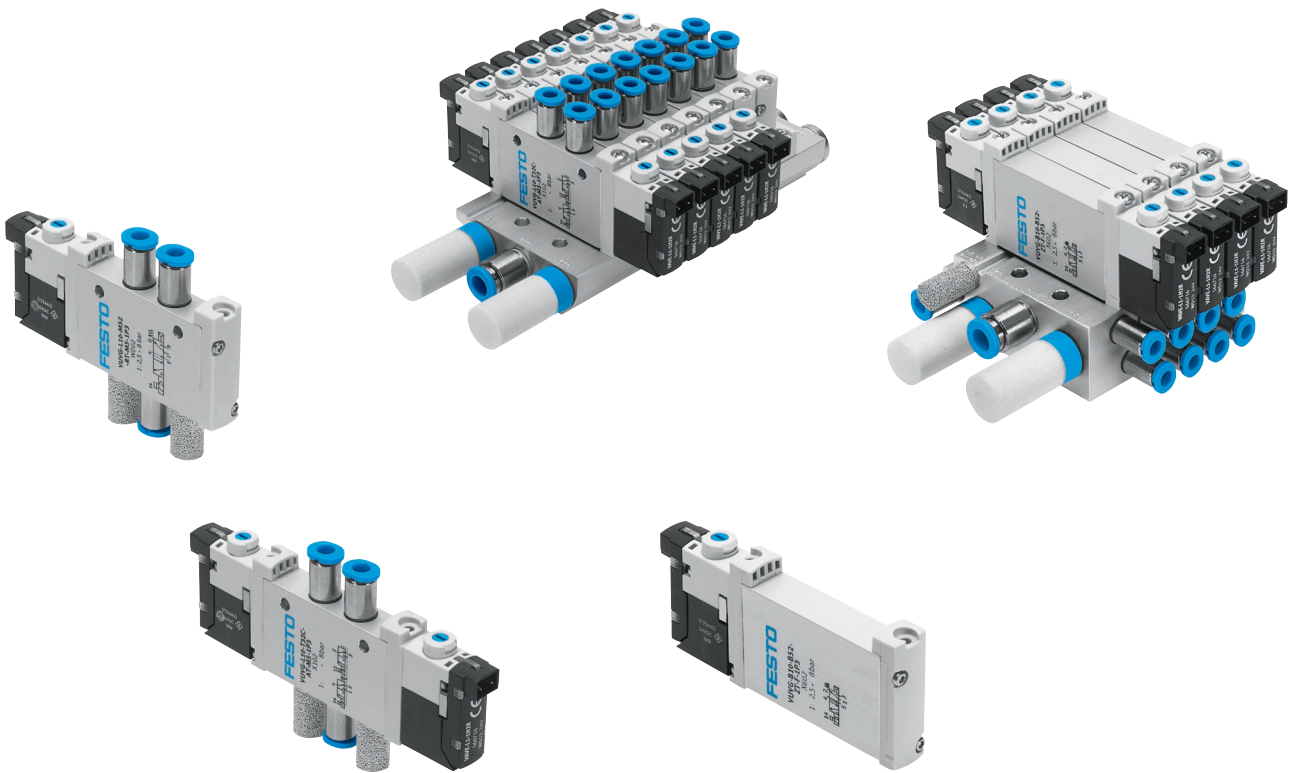

Innovative

- Can be set to internal or external pilot air supply for manifold assemblies with sub-base valves
- Maximum pressure 10 bar
- Design principle:
 - Piston spool with sealing ring (VUVG-LK, VUVG-BK)
 - Piston spool with sealing cartridge (VUVG-L, VUVG-B)

Versatile

- Wide range of valve functions
- Choice of quick push-in connectors
- In-line valves
- Semi in-line valves for manifold assembly
- M5 and M7 in-line valves can be combined on one manifold rail
- Valve manifold with pressure zones
- IP40, IP65
- Connection technology via:
 - Electrical connection box (E-box)
 - Pneumatic interface CNOMO, to ISO 15218

Reliable

- Sturdy and durable metal components
 - Valves
 - Manifold rails
- Fast troubleshooting thanks to 360° LED display
- Reliable servicing thanks to valves that can be replaced quickly and easily
- Choice of manual override: non-detenting, covered, non-detenting/detenting or detenting (without accessories)

Easy to install

- Solid wall mounting or DIN rail mounting
- Easy mounting, captive screws and seal
- Connection technology easy to change via the E-box
- Inscription label holder for labelling the valves

Ordering data – Product options

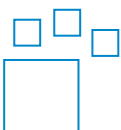

Configurable product
This product and all its product options can be ordered using the configurator.

The configurator can be found at
→ www.festo.com/catalogue/...
Enter the part number or the type.

Part no.	Type
564212	VUVG
575203	VUVG-...T1
8163285	VUVG-...F1A

Key features – Pneumatic components

Individual valves and valve manifold assemblies

In-line valves as individual valve

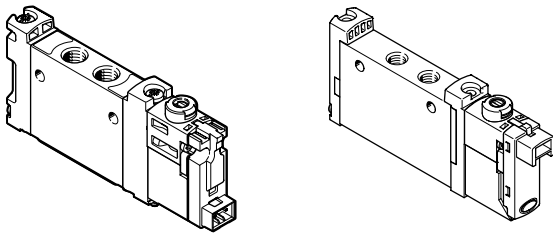

In-line valves are designed to be used without pneumatic links. All pneumatic connections are on the valve and can be equipped with fittings/tubing. The electrical connection is established via different E-boxes.

If a special seal set is used, in-line valves VUVG can also be mounted on a manifold rail (pneumatic linking) as semi in-line valves.

In-line valve VUVG-LK/VUVG-L

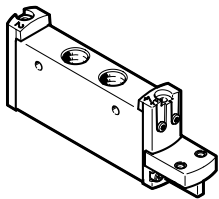

The in-line valve VTUG-L...-P1 to ISO 15218 is a solenoid valve without electrical pilot control. The basic valve with the CNOMO pneumatic interface to ISO 15218 can be equipped with pilot controls with the following electrical connection:

- Connection type C (DIN EN175301-803)
- Connection type C to industry standard
- M12 connection (IEC 61076-2-101)

In-line valve VUVG-L to ISO 15218 (CNOMO)

Semi in-line valves for manifold assembly

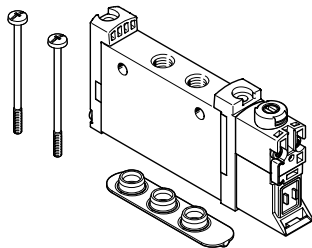

Semi in-line valve VUVG-S

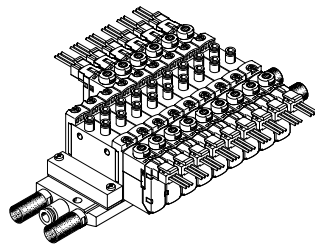

Valve manifold assembly VTUG comprising semi in-line valves VUVG-S

The supply ports (1, 3 and 5) for semi in-line valves are connected to the valve by common pneumatic links (e.g. sub-base).

The working ports (2, 4) are on the valve. The electrical connection is established via different E-boxes.

Sub-base valves for manifold assembly

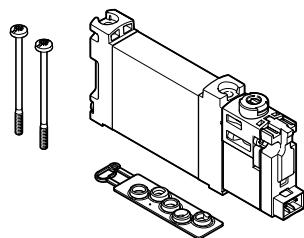

Sub-base valve VUVG-BK/VUVG-B

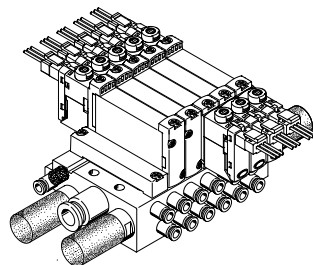

Valve manifold assembly VTUG comprising sub-base valves VUVG-BK/VUVG-B

The supply ports (1, 3 and 5) and the working ports (2, 4) of sub-base valves are connected through the sub-base or the

manifold. The electrical connection is established via different E-boxes.

Key features – Pneumatic components

Basic valves VUVG

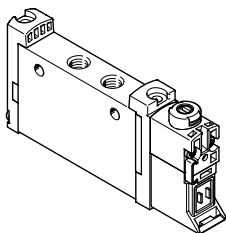

- Size 10, 14 and 18 mm
- In-line valves and semi in-line valves
- Sub-base valves
- 2x 3/2-way, 5/2-way and 5/3-way valves

E-boxes

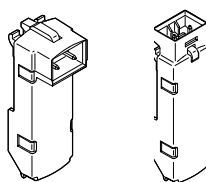

- 5, 12 and 24 V DC
- With or without holding current reduction
- LED

Combinations of basic valve and E-boxes

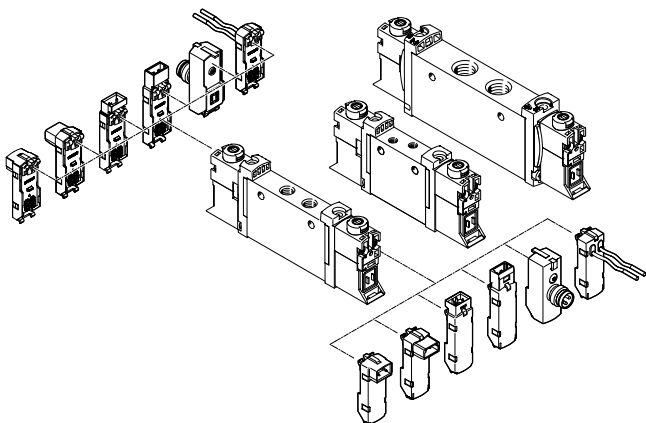

 **Note**
More E-boxes → page 113

Cover caps for manual override

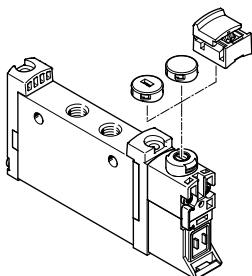

- Closed cover cap, covered manual override
- Slotted cover cap, non-detenting manual override
- Cover, detenting manual override

Inscription label holder

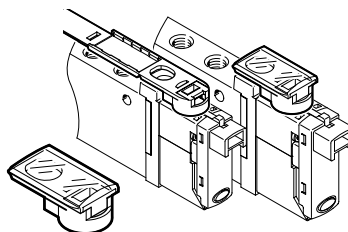

- The identification holder is mounted in the same way as a cover cap for manual override
- The identification holder folds over to cover the retaining screw and the manual override

Key features – Pneumatic components

Manifold rail for in-line valves

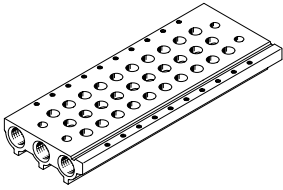

- For in-line valves M3, M5, M7, G1/8 and G1/4
- For 2x 3/2-way, 5/2-way and 5/3-way valves
- 2 to 10 and 12, 14, 16 valve positions

Manifold rail for sub-base valves

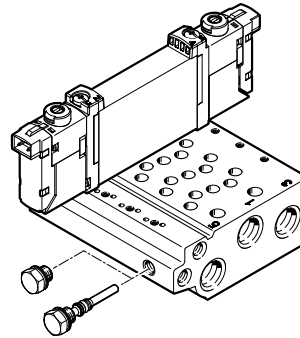

- For sub-base valves 10A, 10, 14 and 18
- Manifold rail with M5, M7, G1/8 and G1/4 working ports
- For 2x 3/2-way, 5/2-way and 5/3-way valves
- 2 to 10, 12, 14 and 16 valve positions
- The sub-base valves are always supplied with external pilot air. The pilot air is set via the manifold rail. A short and a long blanking plug are therefore included in the scope of delivery of the manifold rail.

 **Note**

Pressurisation and exhaust at both ends is recommended for an optimised flow rate in cases where multiple valves switch simultaneously.

Cover plate for vacant position

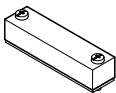

Vacant position cover

Supply plate

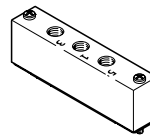

For additional air supply and exhaust via a valve position

Separator for pressure zones



For creating multiple pressure zones in a valve manifold assembly

Key features – Pneumatic components

Vertical pressure supply plate

For in-line valves M5/M7 and G1/8

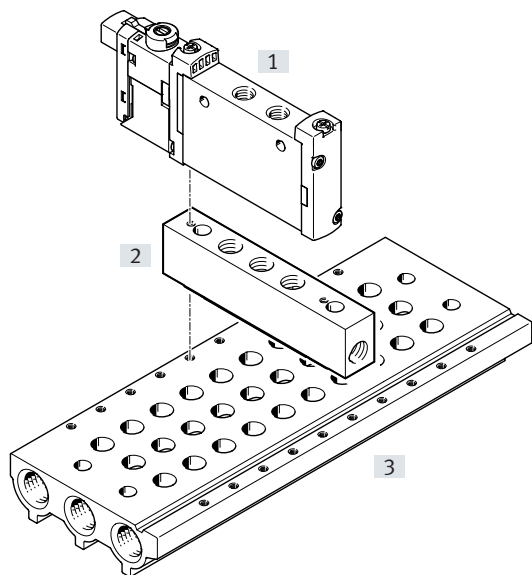

- [1] In-line valves VUVG
- [2] Vertical pressure supply plate
- [3] Manifold rail

The vertical pressure supply plate allows the valve mounted on it to be pressurised and exhausted separately.

If two vertical pressure supply plates are mounted on top of each other, the valve can be supplied with compressed air and exhausted completely independently of the valve terminal (terminal code CS).

Code	Type	For in-line valves		Description
		M5/M7	G1/8	
ZU	VABF-L1-P3A	■	■	Plate with port 1 for supplying an individual operating pressure or separate exhausting (reverse operation) for a valve position.
ZV	VABF-L1-P7A	■	■	Plate with ports 3 and 5 for exhausting the valve or supplying an individual operating pressure (reverse operation) for a valve position.

Key features – Pneumatic components

Exhaust functions

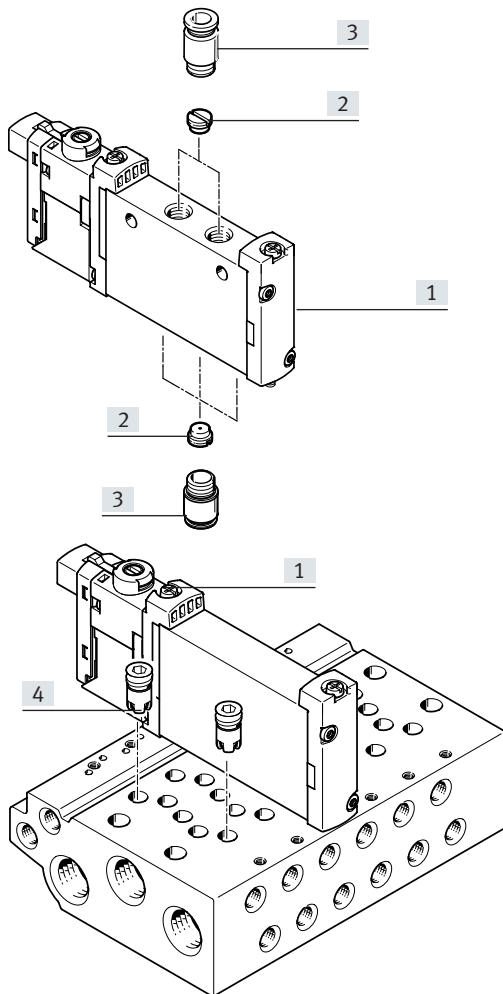

- [1] Valves VUVG with individual electrical connection
- [2] Flow restrictor for M5 thread
- [3] Fitting
- [4] Fixed flow restrictor, self-tapping/check valve

Flow control valve for M5 thread

In-line valve, individual electrical connection: flow restrictor can be fitted in port 1, 3, 5 and/or in port 2, 4.

Sub-base valve, individual electrical connection: flow control valve can be fitted in port 2, 4.

Fixed flow restrictor, self-tapping

The fixed flow restrictor can be used to permanently set the exhaust flow rate in ducts 3 and 5.

The fixed flow restrictors are screwed into ducts 3 and 5 in the manifold rail.

Please see the relevant assembly instructions:
www.festo.com/catalogue/... → Support/Downloads

Check valve

Check valves block the flow towards the valves, thus preventing actuators from switching unexpectedly if back pressure develops in ducts 3 and 5 in the case of a high exhaust capacity. The check valves are screwed into ducts 3 and 5 in the manifold rail.

Please see the relevant assembly instructions:
www.festo.com/catalogue/... → Support/Downloads

**Note**

- It is not possible to use a check valve and a fixed flow restrictor (in the same duct) at the same time.
- When screwing in again, use the threads already present.

Key features – Pneumatic components

Creating pressure zones and separating exhaust air

Compressed air is supplied and exhausted via the manifold rail and via supply plates. The position of the supply plates and channel separations can be freely selected with the VUVG.

Pressure zones are created by isolating the internal supply ducts between the manifold sub-bases by appropriate duct separation.









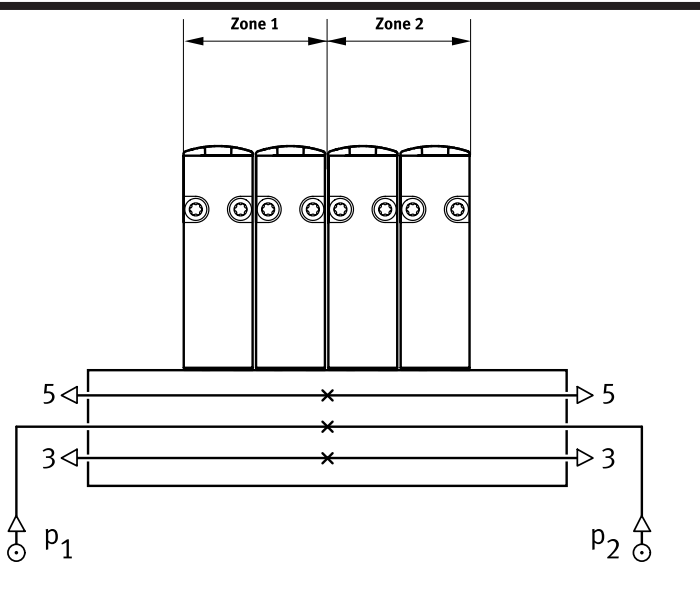

Pressure zone separation can be used for the following ducts:

- Duct 1
- Duct 3
- Duct 5

Note

- Use a separator if the exhaust air pressures are high
- Use at least one supply plate/air supply for each pressure zone
- Pressure zone separation is not possible in duct 12/14 (pilot air supply)

Duct separation

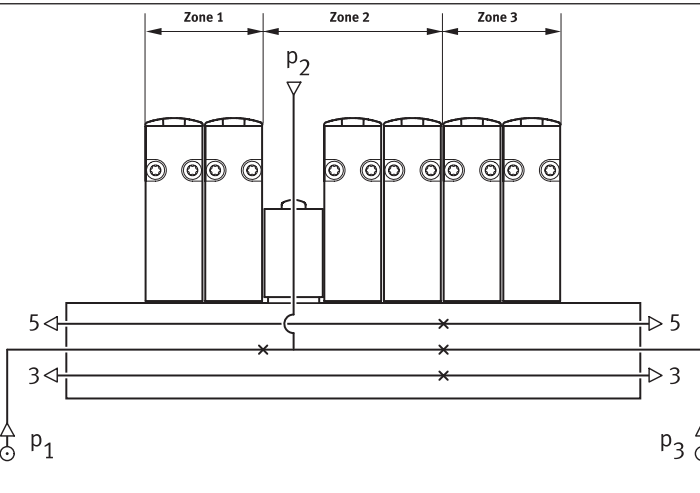
Duct separation	Description						
	<p>The pressure zones can be freely configured with the VUVG. The following duct separations are possible:</p> <table border="1"> <tr> <td data-bbox="788 792 1094 976">Duct 1 closed</td> <td data-bbox="1094 792 1484 976">  </td> </tr> <tr> <td data-bbox="788 976 1094 1160">Duct 1, 3, 5 closed</td> <td data-bbox="1094 976 1484 1160">  </td> </tr> <tr> <td data-bbox="788 1160 1094 1339">Duct 3, 5 closed</td> <td data-bbox="1094 1160 1484 1339">  </td> </tr> </table>	Duct 1 closed		Duct 1, 3, 5 closed		Duct 3, 5 closed	
Duct 1 closed							
Duct 1, 3, 5 closed							
Duct 3, 5 closed							
	<p>The number of pressure zones with the VUVG is only limited by the number of valve positions on the manifold rail. Note that each supply plate occupies one valve position.</p>						

Separator VABD

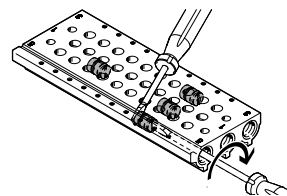

Note

As the separators are only fitted from one side using a slotted screwdriver, several pressure zones can be created in one profile.

Key features – Pneumatic components

Pilot air supply

Internal pilot air supply

Internal pilot air supply can be chosen with an operating pressure between 0.15 ... 0.8 MPa, 0.25 ... 0.8 MPa, or 0.3 ... 0.8 MPa (depending on the valve used).

The pilot air supply is branched from duct 1 (compressed air supply) using an internal connection.

External pilot air supply

External pilot air supply is required for vacuum operation. The port for external pilot air supply (port 12/14) is located on the valve in the case of in-line valves and on the manifold rail in the case of sub-base valves.

Pilot exhaust air

With in-line valves, the pilot exhaust air escapes via exhaust holes. With sub-base valves, the pilot exhaust air is discharged via duct 82/84 of the manifold rail.

Pilot air supply with in-line and semi in-line valves

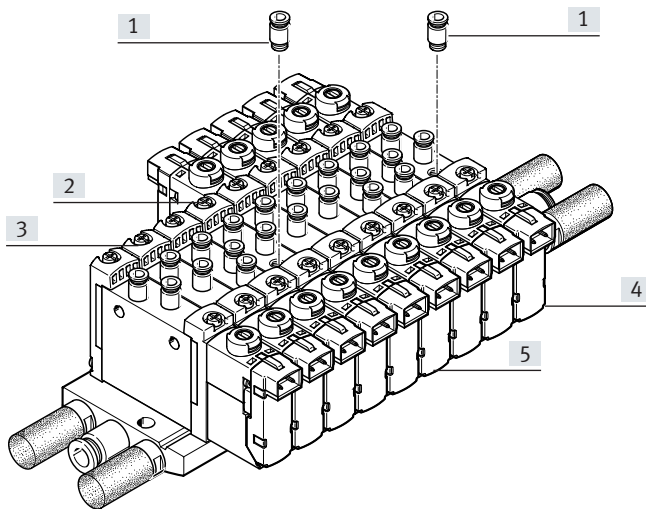

- [1] Push-in fitting for external pilot air supply at port 12/14
- [2] Single solenoid valve with external pilot air supply
- [3] Single solenoid valve with internal pilot air supply
- [4] Double solenoid valve with external pilot air supply
- [5] Double solenoid valve with internal pilot air supply

The internal pilot air is branched from port 1 in the valve body. The external pilot air (port 12/14) is supplied individually at each valve housing.

Note

Semi in-line valves cannot be supplied centrally with pilot air via the manifold rail.

Pilot air supply with sub-base valves

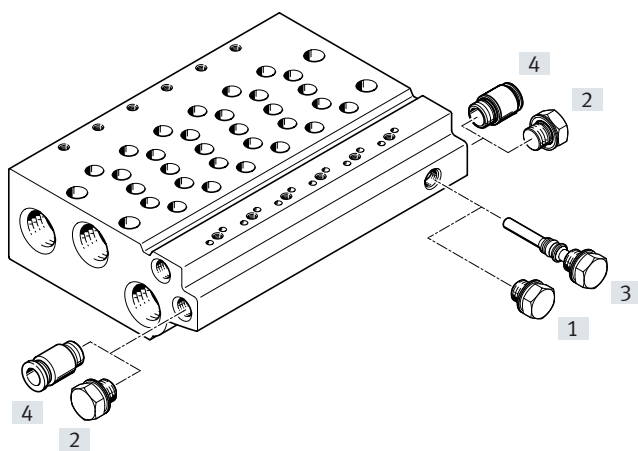

- [1] Blanking plug, short, for internal pilot air
- [2] Blanking plug for duct 12/14 with internal pilot air
- [3] Blanking plug, long, for external pilot air
- [4] Push-in fitting in duct 12/14 with external pilot air

The manifold rails for sub-base valves have an internal connection between duct 12/14 and duct 1. By inserting a blanking plug into this connection, it is possible to switch between internal and external pilot air.

Key features – Pneumatic components

Operation with different pressures

Vacuum operation

Points to note with 3/2-way valves

The 3/2-way valves are available in a design with two valves in one valve body and with pneumatic spring return. With these valves, the force for the return movement is obtained from port 1.

Vacuum operation is therefore only possible at port 3 and 5, not at port 1.

With external pilot air supply, vacuum can be connected at port 1, 3, 5 of the 5/2-way and 5/3-way valves.

Reverse operation

The 3/2-way valves with pneumatic spring are not suitable for reverse operation, since at least the minimum pilot pressure must be available at duct 1.

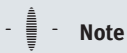

Note

Pressure must be available at port 1.

Pressure divider (internal pilot air)

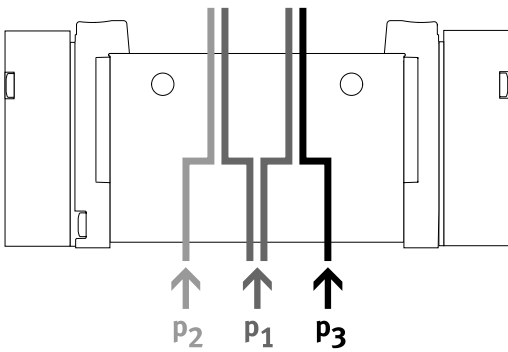

- If two different pressures are required.

- Different pressures can be supplied at duct 1, 3 and 5.



Note

- With internal pilot air supply, the minimum pilot pressure must be adhered to in duct 1
- With 2x 3/2-way valves without spring return, the minimum pilot pressure must always be adhered to in duct 1

Advantages

Either pressure or vacuum can be connected at ducts 3 and 5 both with external and internal pilot air.

Vacuum, ejector pulse and normal position

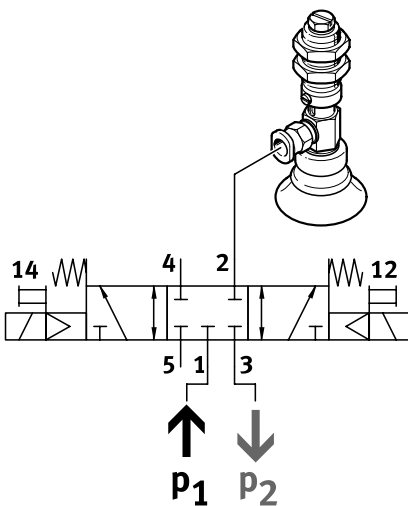

Vacuum, ejector pulse and normal position can be achieved as follows:

- Internal pilot air supply
- Vacuum in duct 3
- Pressure for the ejector pulse in duct 1

Key features – Mounting

Mounting – Individual valve VUVG

Cylinder mounting

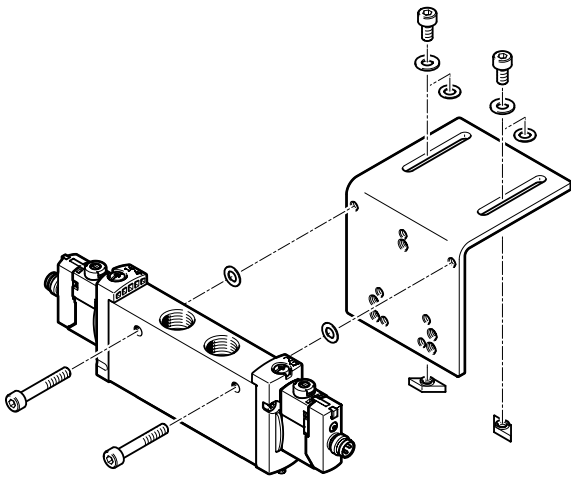

For mounting individual valves directly on a drive.

The solenoid valves are provided with two through-holes for attaching to the cylinder mounting DAVM-MW-V1...-V.

Mounting is only possible on the side on which the pneumatic connections are located.

The relevant screw set is included when the cylinder mounting DAVM-MW-V1...-V is ordered.

Product range overview

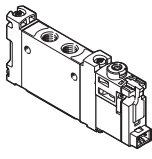
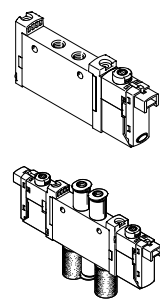
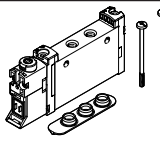
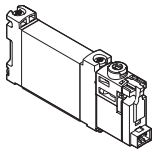
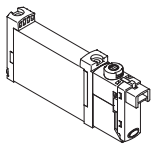
Design	Working port	Size	Functions and flow rate [l/min]											→ Page/ Internet			
			T32C	T32U	T32H	T32C/M	T32U/M	T32H/M	M52	M52/M	B52	P53C	P53U		P53E		
In-line valve as individual valve, solenoid valve VUVG-LK																	
	M5	10	■ 180	-	-	-	-	-	-	■ 195	-	■ 195	-	-	-	30	
	M7	10	■ 280	-	-	-	-	-	-	■ 340	-	■ 340	-	-	-		34
	G1/8	14	■ 570	-	-	-	-	-	-	■ 660	-	■ 660	-	-	-		
In-line valve as individual valve, solenoid valve VUVG-L																	
	M3	10A	-	-	-	-	-	-	-	■ 100	■ 80	■ 100	■ 90	■ 90	■ 90	24	
	M5	10	■ 150	■ 150	■ 150	■ 135	■ 125	■ 125	■ 220	■ 190	■ 220	■ 210	■ 210	■ 210	38		
	M7	10	■ 190	■ 190	■ 190	■ 150	■ 140	■ 140	■ 330	■ 220	■ 380	■ 320	■ 320	■ 320			44
	G1/8	14	■ 560	■ 600	■ 590	■ 550	■ 500	■ 500	■ 780	■ 780	■ 780	■ 650	■ 560	■ 560	57		
	G1/4	18	■ 880	■ 970	■ 950	■ 870	■ 990	■ 920	■ 1300	■ 1300	■ 1380	■ 1200	■ 1000	■ 910			69
Semi in-line valve for manifold assembly, solenoid valve VUVG-S																	
	M5	10	■ 150	■ 150	■ 150	■ 135	■ 125	■ 125	■ 220	■ 190	■ 220	■ 210	■ 210	■ 210	38		
	M7	10	■ 190	■ 190	■ 190	■ 150	■ 140	■ 140	■ 330	■ 220	■ 380	■ 320	■ 320	■ 320		44	
	G1/8	14	■ 560	■ 600	■ 590	■ 550	■ 500	■ 500	■ 780	■ 780	■ 780	■ 650	■ 560	■ 560			57
	G1/4	18	■ 880	■ 970	■ 950	■ 870	■ 990	■ 920	■ 1300	■ 1300	■ 1380	■ 1200	■ 1000	■ 910		69	
Sub-base valve, solenoid valve VUVG-BK																	
	M5	10	■ 160	-	-	-	-	-	-	■ 160	-	■ 160	-	-	-	84	
	M7	10	■ 160	-	-	-	-	-	-	■ 160	-	■ 160	-	-	-		84
	G1/8	14	■ 350	-	-	-	-	-	-	■ 380	-	■ 380	-	-	-		
Sub-base valve, solenoid valve VUVG-B																	
	M3	10A	-	-	-	-	-	-	-	■ 100	■ 80	■ 100	■ 90	■ 90	■ 90	79	
	M5	10	■ 150	■ 150	■ 150	■ 130	■ 120	■ 120	■ 210	■ 180	■ 210	■ 200	■ 200	■ 200	87		
	M7	10	■ 160	■ 160	■ 160	■ 140	■ 130	■ 130	■ 270	■ 230	■ 270	■ 250	■ 250	■ 250			87
	G1/8	14	■ 510	■ 510	■ 510	■ 430	■ 410	■ 410	■ 520	■ 570	■ 570	■ 520	■ 500	■ 460	93		
	G1/4	18	■ 800	■ 800	■ 800	■ 800	■ 800	■ 800	■ 1000	■ 1000	■ 1000	■ 950	■ 950	■ 950			103

Product range overview

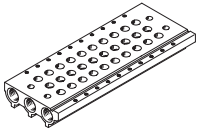
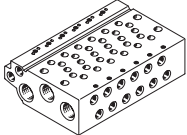
Design	Size	Description	→ Page/ Internet
Manifold rail VABM- ... -S- ... , for in-line valves (manifold assembly)			
	10AS	Size M3	29,
	10S	Size M5, M7	51,
	14S	Size G1/8	67,
	18S	Size G1/4	77
Manifold rail VABM, for sub-base valves (manifold assembly)			
	10AW	Size M3	83,
	10W	Size M5	92,
	10HW	Size M7	102,
	14W	Size G1/8	109
	18W	Size G1/4	

Overview of valve functions

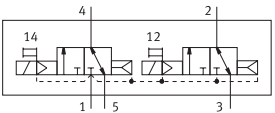
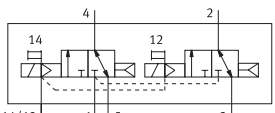
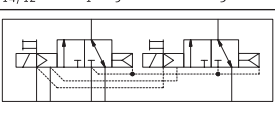
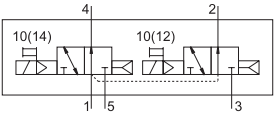
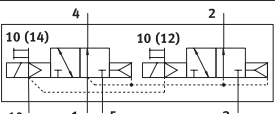
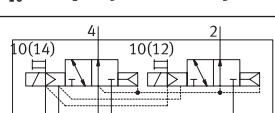
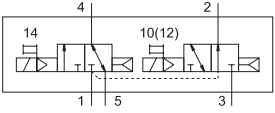
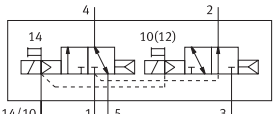
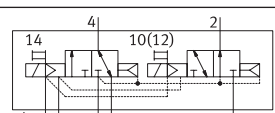
Valve	Valve code	Description	VUVG-LK, VUVG-BK		VUVG-L, VUVG-B			
			Size		Size			
			M5/M7	G1/8	M3	M5/M7	G1/8	G1/4
2x 3/2-way valve, normally closed, pneumatic spring								
	T32C-A	In-line valve, pilot air supply Internal	■	■	-	■	■	■
		In-line valve, pilot air supply External	-	-	-	■	■	-
		Sub-base valve, external pilot air supply	-	-	-	■	■	■
2x 3/2-way valve, normally open, pneumatic spring								
	T32U-A	In-line valve, pilot air supply Internal	-	-	-	■	■	■
		In-line valve, pilot air supply External	-	-	-	■	■	-
		Sub-base valve, external pilot air supply	-	-	-	■	■	■
2x 3/2-way valve, 1x normally open, 1x normally closed, pneumatic spring								
	T32H-A	In-line valve, pilot air supply Internal	-	-	-	■	■	■
		In-line valve, pilot air supply External	-	-	-	■	■	-
		Sub-base valve, external pilot air supply	-	-	-	■	■	■

Overview of valve functions

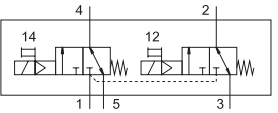
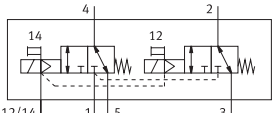
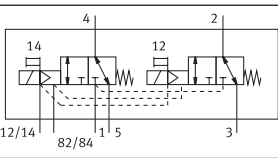
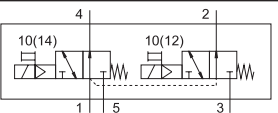
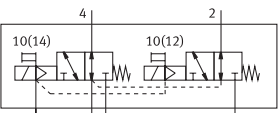
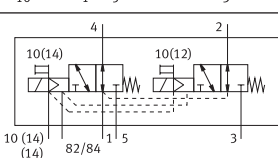
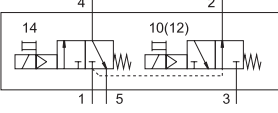
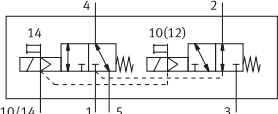
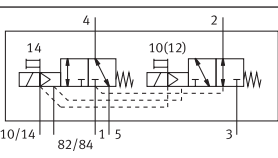
Valve	Valve code	Description	VUVG-LK, VUVG-BK		VUVG-L, VUVG-B			
			Size		Size			
			M5/M7	G1/8	M3	M5/M7	G1/8	G1/4
2x 3/2-way valve, normally closed, mechanical spring								
	T32C-M	In-line valve, pilot air supply Internal	-	-	-	■	■	■
		In-line valve, pilot air supply External	-	-	-	■	■	■
		Sub-base valve, external pilot air supply	-	-	-	■	■	■
2x 3/2-way valve, normally open, mechanical spring								
	T32U-M	In-line valve, pilot air supply Internal	-	-	-	■	■	■
		In-line valve, pilot air supply External	-	-	-	■	■	■
		Sub-base valve, external pilot air supply	-	-	-	■	■	■
2x 3/2-way valve, 1x normally open, 1x normally closed, mechanical spring								
	T32H-M	In-line valve, pilot air supply Internal	-	-	-	■	■	■
		In-line valve, pilot air supply External	-	-	-	■	■	■
		Sub-base valve, external pilot air supply	-	-	-	■	■	■

Overview of valve functions

Valve	Valve code	Description	VUVG-LK, VUVG-BK		VUVG-L, VUVG-B			
			Size		Size			
			M5/M7	G1/8	M3	M5/M7	G1/8	G1/4
5/2-way valve, double solenoid								
	B52	In-line valve, pilot air supply Internal	■	■	■	■	■	■
		In-line valve, pilot air supply External	-	-	■	■	■	■
		Sub-base valve, external pilot air supply	-	-	■	■	■	■
5/2-way valve, single solenoid, pneumatic spring								
	M52-A	In-line valve, pilot air supply Internal	■	■	-	-	■	-
		In-line valve, pilot air supply External	-	-	-	-	■	-
		Sub-base valve, external pilot air supply	-	-	-	-	■	-
5/2-way valve, single solenoid, mechanical spring								
	M52-M	In-line valve, pilot air supply Internal	-	-	■	■	■	■
		In-line valve, pilot air supply External	-	-	■	■	■	■
		Sub-base valve, external pilot air supply	-	-	■	■	■	■
5/2-way valve, single solenoid, pneumatic/mechanical spring								
	M52-R	In-line valve, pilot air supply Internal	-	-	■	■	-	■
		In-line valve, pilot air supply External	-	-	■	■	-	■
		Sub-base valve, external pilot air supply	-	-	■	■	-	■

Overview of valve functions

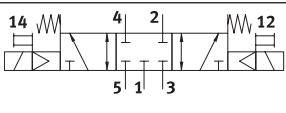
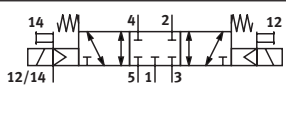
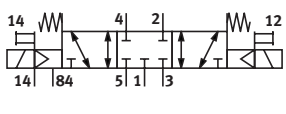
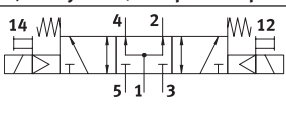
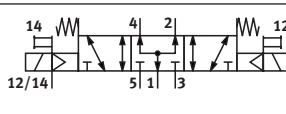
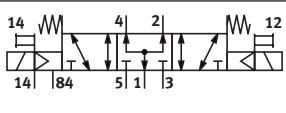
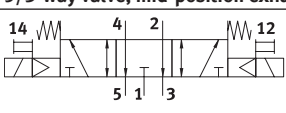
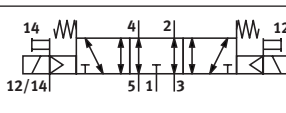
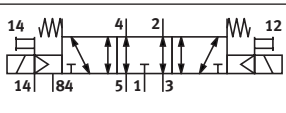
Valve	Valve code	Description	VUVG-LK, VUVG-BK		VUVG-L, VUVG-B			
			Size		Size			
			M5/M7	G1/8	M3	M5/M7	G1/8	G1/4
5/3-way valve, mid-position closed								
	P53C	In-line valve, pilot air supply Internal	-	-	■	■	■	■
		In-line valve, pilot air supply External	-	-	■	■	■	■
		Sub-base valve, external pilot air supply	-	-	■	■	■	■
5/3-way valve, mid-position pressurised								
	P53U	In-line valve, pilot air supply Internal	-	-	■	■	■	■
		In-line valve, pilot air supply External	-	-	■	■	■	■
		Sub-base valve, external pilot air supply	-	-	■	■	■	■
5/3-way valve, mid-position exhausted								
	P53E	In-line valve, pilot air supply Internal	-	-	■	■	■	■
		In-line valve, pilot air supply External	-	-	■	■	■	■
		Sub-base valve, external pilot air supply	-	-	■	■	■	■

Peripherals overview example – In-line valves

Manifold assembly

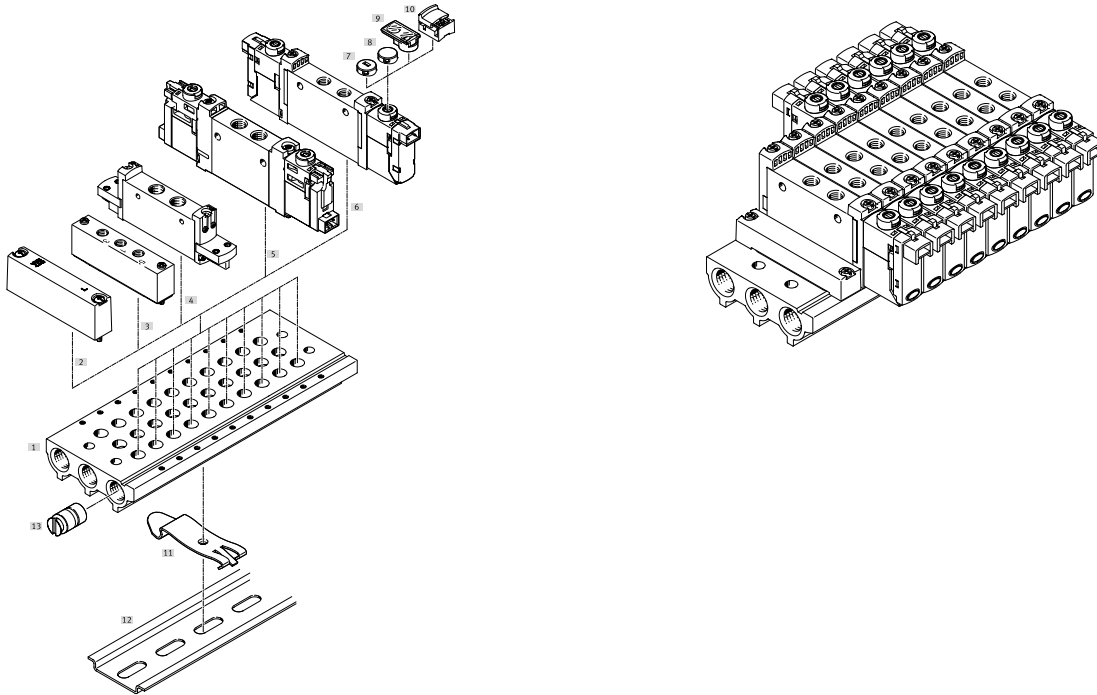

Manifold assembly and accessories

	Type	Description	→ Page/Internet
[1] Manifold rail	VABM-L1-...	For 2 to 10, 12, 14 and 16 valve positions	91
[2] Cover plate	VABB-L1-...	For covering a vacant position	29
[3] Supply plate	VABF-L1-...	For air supply at duct 1 and duct 3 and 5	29
[4] Solenoid valve	VUVG-...-P1	In-line valve 2x 3/2-, 5/2- and 5/3-way	65
[5] Solenoid valve	VUVG-LK...	In-line valve 2x 3/2-, 5/2- and 5/3-way	30
[6] Solenoid valve	VUVG-L...	In-line valve 2x 3/2-, 5/2- and 5/3-way	30
[7] Cover cap (non-detenting)	VMPA-HB...-B	For manual override	118
[8] Cover cap (concealed)	VMPA-HB...-B	For manual override	118
[9] Inscription label holder	ASLR-D	For labelling the valves, covering the retaining screw and the manual override	118
[10] Cover cap (detenting)	VAMC-L1-...	For manual override	118
[11] H-rail mounting	VAME-T-M4	2 pieces for attaching the valve manifold to the H-rail	118
[12] H-rail	NRH-35-2000	For mounting the valve manifold assembly	118
[13] Separator	VABD-...	For creating pressure zones	29

Peripherals overview example – In-line valves

Manifold assembly

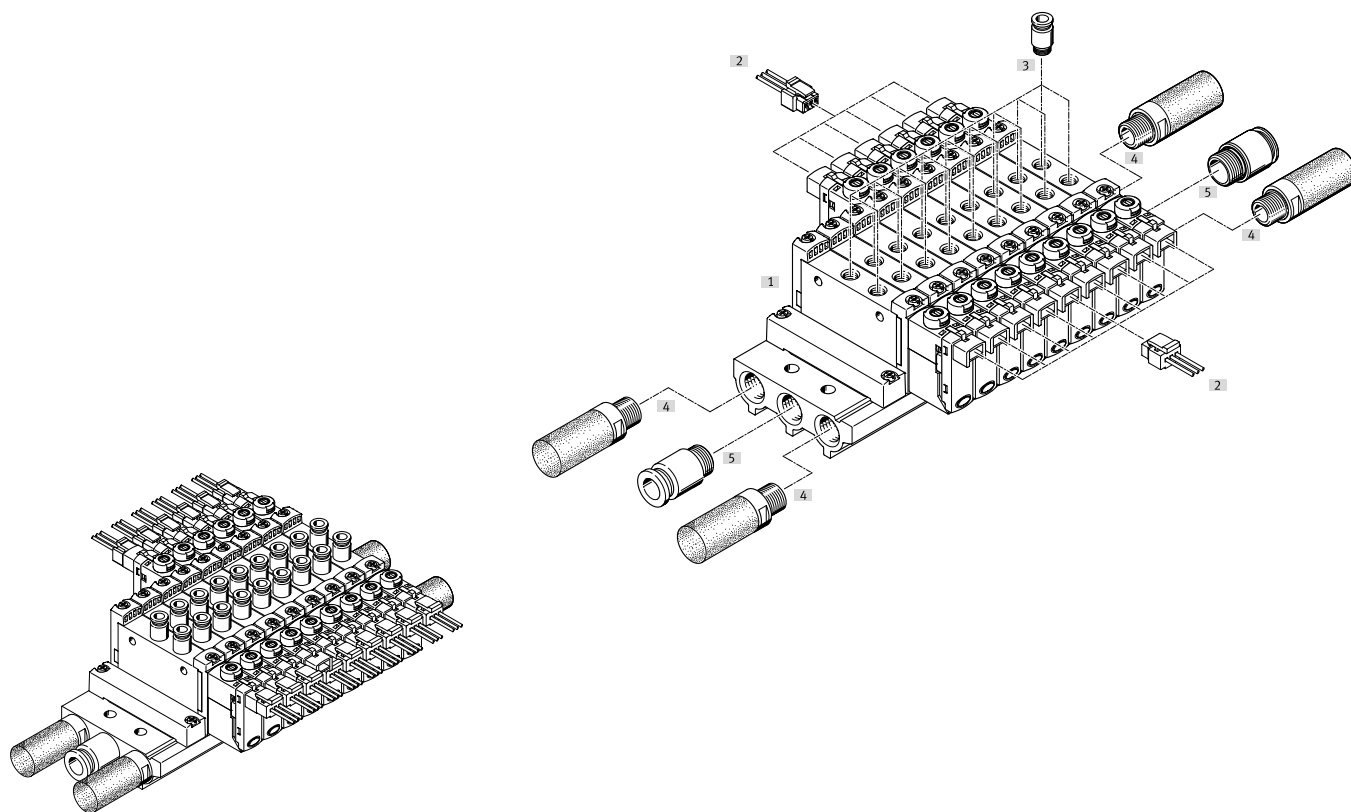

Manifold assembly and accessories		Type	Description	→ Page/Internet
[1]	Manifold rail	VABM-L1-...	For 2 to 10, 12, 14 and 16 valve positions	91
[2]	Plug socket with cable	NEBV-H1G2-...-LE2	For E-box H2 and H3	116
[3]	Push-in fitting	QS...	Push-in fitting for duct 2 and 4	117
[4]	Silencer	U...	For duct 3 and 5	118
[5]	Push-in fitting	QS...	Push-in fitting for air supply at duct 1	117

Peripherals overview example – Sub-base valves

Manifold assembly

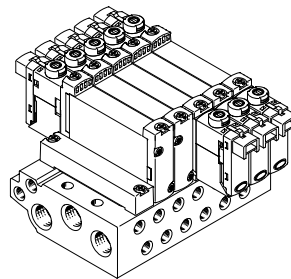
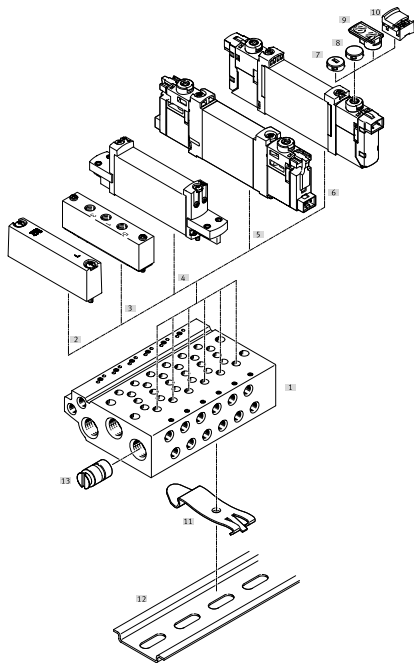

Manifold assembly and accessories

	Type	Description	→ Page/Internet
[1] Manifold rail	VABM-L1-...	For 2 to 10, 12, 14 and 16 valve positions	91
[2] Cover plate	VABB-L1-...	For covering a vacant position	92
[3] Supply plate	VABF-L1-...	For air supply at duct 1 and duct 3 and 5	92
[4] Solenoid valve	VUVG-...-P1	Sub-base valve 2x 3/2-way, 5/2-way and 5/3-way	100
[5] Solenoid valve	VUVG-BK...	Sub-base valve 2x 3/2-way, 5/2-way and 5/3-way	84
[6] Solenoid valve	VUVG-B...	Sub-base valve 2x 3/2-way, 5/2-way and 5/3-way	84
[7] Cover cap (non-detenting)	VMPA-HB...-B	For manual override	118
[8] Cover cap (concealed)	VMPA-HB...-B	For manual override	118
[9] Inscription label holder	ASLR-D	For labelling the valves, covering the retaining screw and the manual override	118
[10] Cover cap (detenting)	VAMC-L1-...	For manual override	118
[11] H-rail mounting	VAME-T-M4	2 pieces for attaching the valve manifold to the H-rail	118
[12] H-rail	NRH-35-2000	For mounting the valve manifold assembly	118
[13] Separator	VABD- ...	For creating pressure zones	92

Peripherals overview example – Sub-base valves

Manifold assembly

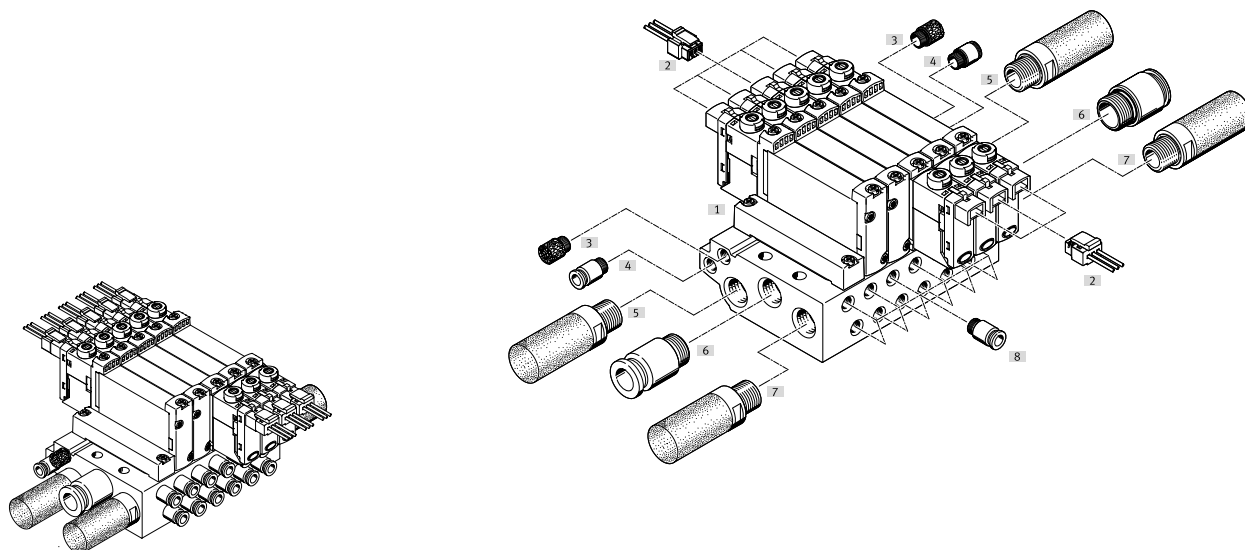

Manifold assembly and accessories				
	Type	Description	→ Page/Internet	
[1]	Manifold rail	VABM-L1-...	For 2 to 10, 12, 14 and 16 valve positions	91
[2]	Plug socket with cable	NEBV-H1G2-KN-...-LE2	For E-box H2 and H3	116
[3]	Silencer	U...	Silencer for pilot air exhaust at duct 82/84	118
[4]	Push-in fitting	QS...	Push-in fitting for pilot air supply at duct 12/14	117
[5]	Silencer	U...	For duct 3 and 5	118
[6]	Push-in fitting	QS...	Push-in fitting for air supply at duct 1	117
[7]	Silencer	U...	For duct 3 and 5	118
[8]	Push-in fitting	QS...	Push-in fitting for duct 2 and 4	117

Type codes

001	Series
VUVG	Solenoid valve
002	Directional control valve type
L	In-line valve
S	Semi-inline valve
B	Sub-base valve
003	Design principle
	Piston spool
K	Piston spool with sealing ring
004	Size
10A	Size 10, deviating flow
10	Size 10
14	Size 14
18	Size 18
005	Valve function
T32U	2x3/2-way valve, normally open
T32C	2x3/2-way valve, normally closed
T32H	2x3/2-way valve, 1x normally closed, 1x normally open
B52	5/2-way valve, double solenoid/bistable
M52	5/2-way valve, single solenoid/monostable
P53U	5/3-way valve, mid-position pressurised
P53E	5/3-way valve, mid-position exhausted
P53C	5/3-way valve, mid-position closed
006	Reset method for monostable/single solenoid valves
	None
A	Pneumatic spring
M	Mechanical spring
R	Mixed, pneumatic/mechanical spring
007	Pilot air
	Internal
Z	External
008	Manual override
	None
H	Non-detenting
S	Covered
Y	Detenting
T	Non-detenting, detenting with accessories

009	Pneumatic connection
M3	M3
G18	G1/8
G14	G1/4
M5	M5
M7	M7
Q4H	Push-in connector 4 mm, with connecting thread M7
Q6H	Push-in connector 6 mm, with connecting thread M7
Q3	Push-in connector 3 mm
Q4	Push-in connector 4 mm
Q6	Push-in connector 6 mm
Q8	Push-in connector 8 mm
Q10	Push-in connector 10 mm
T18	Push-in connector 1/8"
T532	Push-in connector 5/32"
T316	Push-in connector 3/16"
T316H	Push-in connector for 3/16", M7
T14	Push-in connector 1/4"
T14H	Push-in connector for 1/4", M7
T38	Push-in connector 3/8"
T516	Push-in connector 5/16"
T516H	Push-in connector 5/16", M7
F	Flange/sub-base

010	Exhaust
QN	With fitting
	No fitting
U	Silencer

011	Nominal operating voltage
	None
1	24 V DC
1A	24 V AC/50-60 Hz
4	5 V DC
5	12 V DC

012	Electrical connection
	None
P3	Without electrical sub-base
C1	Plug pattern type C, to EN 175301-803
E1	Individual connection with plug base
H2	Connection pattern H, horizontal plug
H3	Connection pattern H, vertical plug
S2	Connection pattern S, horizontal plug
S3	Connection pattern S, vertical connector
L1	Leads 0.5 m
L2	Leads 1 m
L3	Leads 2.5 m
L4	Leads 5 m
K6	Cable 0.5 m
K7	Cable 1 m
K8	Cable 2.5 m
K9	Cable 5 m
R8	Individual connector M8, 3-pin
R1	Individual connector M8, 4-pin
R3	Individual plug M12, to EN 61076-2-101
P1	Interface for pilot valve (CNOMO small)

013	Circuitry
	None
R	Holding current reduction with integrated protective circuit

Type codes

014	Display
	None
L	LED

015	Electrical valve accessories
	None
C1	Connecting cable, 0.5 m
C2	Connecting cable 1 m
C3	Connecting cable 2.5 m
C4	Connecting cable, 5 m
D	Connector socket type C
D3	Connecting cable 2.5 m, with plug socket type C
D4	Connecting cable 5 m, with plug socket type C
D6	
D7	
D8	
DL3	Connecting cable 2.5 m, with plug socket type C, LED
DL4	Connecting cable 5 m, with plug socket type C, LED
DL5	Connecting cable 10 m, with plug socket type C, LED
E	
E3	Connecting cable 2.5 m, straight plug socket M12
E4	Connecting cable 5 m, straight plug socket M12
E6	Connecting cable 2.5 m, angled plug socket M12
E7	Connecting cable 5 m, angled plug socket M12
EL	
N1	Connecting cable 2.5 m, straight plug socket M8, 3-pin
N2	Connecting cable 5 m, straight plug socket M8, 3-pin
N3	Connecting cable 2.5 m, angled plug socket M8, 3-pin
N4	Connecting cable 5 m, angled plug socket M8, 3-pin
N5	Connecting cable 2.5 m, straight plug socket M8, 4-pin
N6	Connecting cable 5 m, straight plug socket M8, 4-pin
N7	Connecting cable 2.5 m, angled plug socket M8, 4-pin
N8	Connecting cable 5 m, angled plug socket M8, 4-pin
S1	Connecting cable, 0.5 m, S-connector
S2	Connecting cable 1 m, S-connector
S3	Connecting cable 2.5 m, S-connector
S4	Connecting cable, 5 m, S-plug
W1	Connecting cable, flying leads, 0.5 m
W2	Connecting cable, flying leads, 1 m
W3	Connecting cable, flying leads, 2.5 m
W4	Connecting cable, flying leads, 5 m
WS1	Connecting cable, S-plug with flying leads, 0.5 m
WS2	Connecting cable, S-plug with flying leads, 1 m
WS3	Connecting cable, S-plug with flying leads, 2.5 m
WS4	Connecting cable, S-plug with flying leads, 5 m

016	Version
	Expanded properties
S	Focused properties



017	Special material properties
	None
F1A	Recommended for production facilities for the manufacture of lithium-ion batteries

Solenoid valves VUVG-L10A and VUVG-S10A, in-line valves M3

Datasheet

Function

5/2-way, single solenoid
5/2-way, double solenoid valve
5/3C, 5/3U, 5/3E

-  - Size 10 mm
-  - Flow rate
80 ... 100 l/min
-  - Voltage
5, 12 and 24 V DC

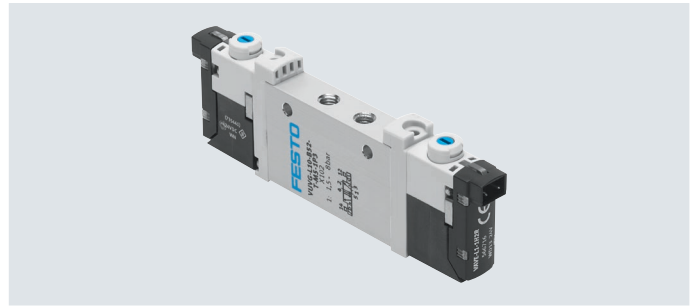

Circuit diagrams → page 14

General technical data VUVG-L

Valve function	M52-R	B52	M52-M	P53
Normal position	–	–	–	C ¹⁾ U ²⁾ E ³⁾
Stable position	Monostable	Bistable	Monostable	Monostable
Pneumatic spring return	Yes ⁴⁾	–	No	–
Mechanical spring return	Yes ⁴⁾	–	Yes	Yes
Vacuum operation at port 1	Only with external pilot air supply			
Design	Piston spool			
Sealing principle	Soft			
Actuation type	Electrical			
Type of control	Piloted			
Pilot air supply	Internal or external			
Exhaust air function	Can be throttled			
Manual override	Choice of non-detenting, covered, non-detenting/detenting or detenting			
Type of mounting	Optionally via through-holes ⁵⁾ or on manifold rail			
Mounting position	Any			
Nominal width [mm]	2		1.4	2
Standard nominal flow rate [l/min]	100		80	90
Flow rate on manifold rail [l/min]	100		80	90
Switching time on/off [ms]	8/15	–	7/21	8/25
Switching time changeover [ms]	–	8	–	14
Size [mm]	10			
Port	1, 2, 3, 4, 5, 12/14 M3			
Product weight [g]	38	49	37	
Certification	c UL us - Recognized (OL) RCM			
CE marking (see declaration of conformity) ⁶⁾	To EU EMC Directive			
Corrosion resistance class CRC ⁷⁾	2			

1) C=Normally closed/mid-position closed

2) U=Normally open/mid-position pressurised

3) E=Mid-position exhausted

4) Combined reset method

5) If several valves are to be screwed together via the through-holes to form a block, a minimum distance of 0.3 mm must be ensured by inserting spacers.

6) For information about the area of use, see the EC declaration of conformity at: www.festo.com/catalogue/... → Support/Downloads.

If the devices are subject to usage restrictions in residential, commercial or light-industrial environments, further measures for the reduction of the emitted interference may be necessary.

7) More information www.festo.com/x/topic/crc

Datasheet

Operating and environmental conditions			M52-R ¹⁾	B52	M52-M ²⁾	P53
Valve function			Compressed air to ISO 8573-2010 [7:4:4]			
Operating pressure	Internal	[MPa]	0.25 ... 0.8	0.15 ... 0.8	0.3 ... 0.8	0.3 ... 0.8
		[bar]	2.5 ... 8	1.5 ... 8	3 ... 8	3 ... 8
	External	[MPa]	-0.09 ... 1			-0.09 ... 0.8
		[bar]	-0.9 ... 10			-0.9 ... 8
Pilot pressure		[MPa]	0.25 ... 0.8	0.15 ... 0.8	0.3 ... 0.8	
		[bar]	2.5 ... 8	1.5 ... 8	3 ... 8	
Ambient temperature		[°C]	-5 ... +50, with holding current reduction -5 ... +60			
Temperature of medium		[°C]	-5 ... +50, with holding current reduction -5 ... +60			

1) Combined pneumatic/mechanical spring

2) Mechanical spring

Electrical data		
Electrical connection		Via E-box → page 111
Operating voltage	[V DC]	5, 12 and 24 ±10%
Power	[W]	1, reduced to 0.35 with holding current reduction
Duty cycle	[%]	100
Protection rating to EN 60529		IP40 (with plug socket), IP65 (with M8)

Information on materials	
Housing	Wrought aluminium alloy
Seals	HNBR, NBR
Note on materials	RoHS-compliant
LABS (PWIS) conformity	VDMA24364-B1/B2-L

Datasheet

Dimensions

Download CAD data → www.festo.com

5/2- and 5/3-way valves

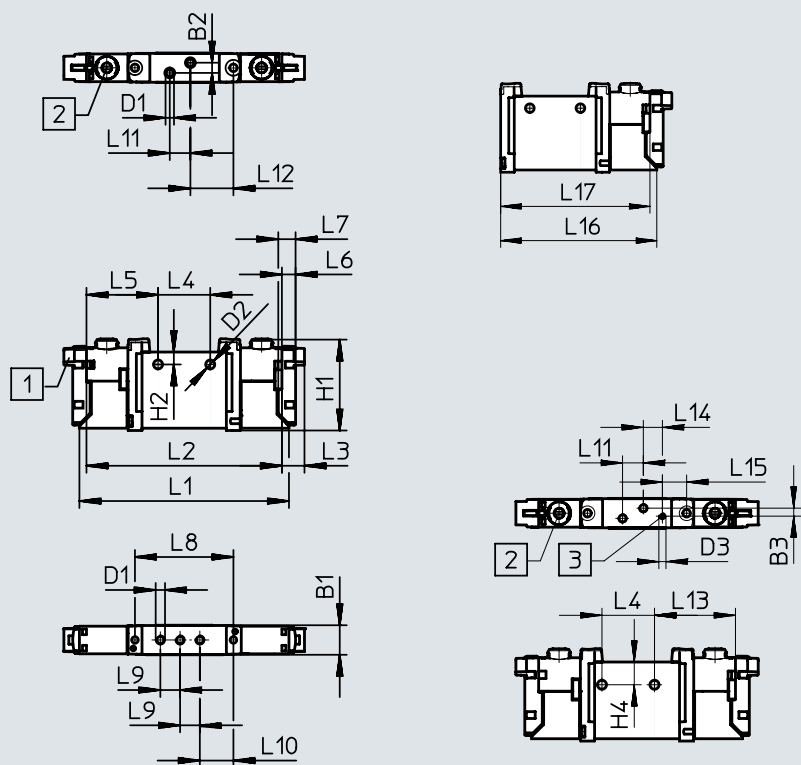

-  - **Note**
 More dimensions for
 E-boxes
 → Page 113

[1] Electrical connection for solenoid valve, horizontal

[2] Manual override

[3] Port for external pilot air supply

Type	B1	B2	B3	D1	D2	D3	H1	H2	L1	L2	L3	L4	L5
VUVG-L10A-...-M3...	10.2	3.6	2.83	M3	3.2	M3	32.5	4.4	74.3	69.3	8	18.5	25.4
VUVG-S10A-...-M3...													

Type	L6	L7	L8	L9	L10	L11	L12	L13	L14	L15	L16	L17
VUVG-L10A-...-M3...	4.85	6.15	34.9	7	11.9	7.3	15.25	28.5	6.7	8.54	57.06	54.56
VUVG-S10A-...-M3...												

Ordering data

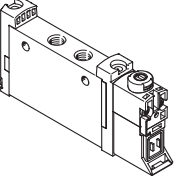
Ordering data	Description	Part no.	Type	
In-line valve M3, without E-box				
	5/2-way valve, single solenoid			
	Internal pilot air supply	Pneumatic/mechanical spring return	566437	VUVG-L10A-M52-RT-M3-1P3
		Mechanical spring return	574345	VUVG-L10A-M52-MT-M3-1P3
	External pilot air supply	Pneumatic/mechanical spring return	566443	VUVG-L10A-M52-RZT-M3-1P3
		Mechanical spring return	574346	VUVG-L10A-M52-MZT-M3-1P3
	5/2-way valve, double solenoid			
	Internal pilot air supply		566438	VUVG-L10A-B52-T-M3-1P3
	External pilot air supply		566444	VUVG-L10A-B52-ZT-M3-1P3
	5/3-way valve			
	Internal pilot air supply	Mid-position closed, mechanical spring return	566439	VUVG-L10A-P53C-T-M3-1P3
Mid-position exhausted, mechanical spring return		566440	VUVG-L10A-P53E-T-M3-1P3	
Mid-position pressurised, mechanical spring return		566441	VUVG-L10A-P53U-T-M3-1P3	
External pilot air supply	Mid-position closed, mechanical spring return	566445	VUVG-L10A-P53C-ZT-M3-1P3	
	Mid-position exhausted, mechanical spring return	566446	VUVG-L10A-P53E-ZT-M3-1P3	
	Mid-position pressurised, mechanical spring return	566447	VUVG-L10A-P53U-ZT-M3-1P3	

Manifold assembly

In-line valves for manifold assembly



Dimensions

Download CAD data → www.festo.com

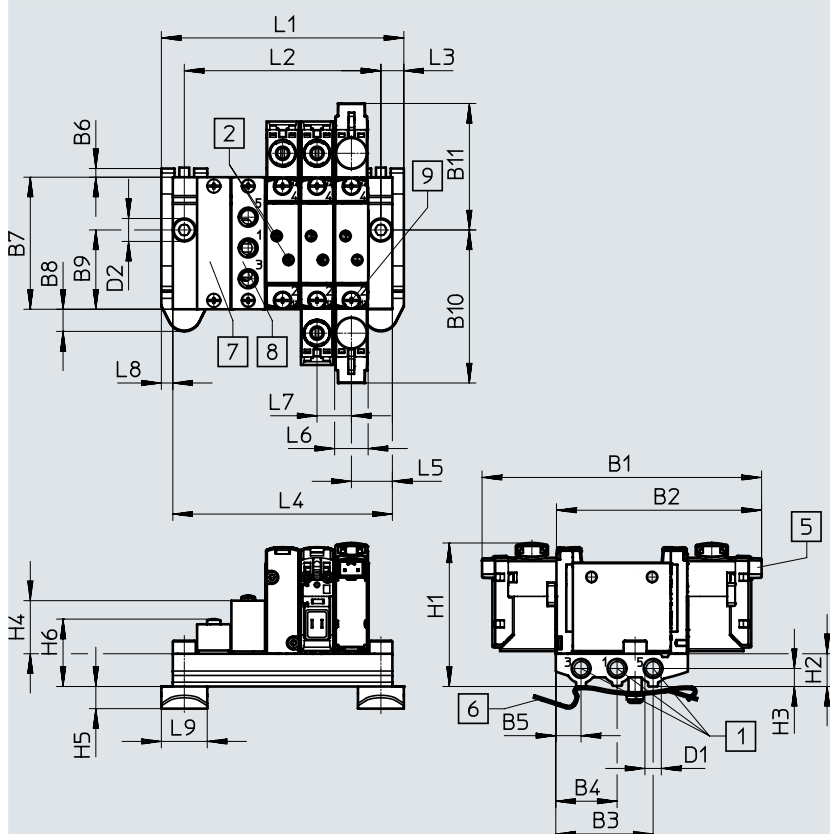

 **Note**
More dimensions for
E-boxes
→ Page 113

- [1] Ports 1, 3 and 5: M5 (at both ends)
- [2] Ports 2 and 4: M3
- [5] Electrical connection for E-boxes and accessories
- [6] H-rail mounting (two M4x16 screws are required for mounting)
- [7] Cover plate
- [8] Supply plate, ports 1, 3 and 5: M5
- [9] Valves/cover plate mounting on manifold rail: M2 thread

Type	B1	B2	B3	B4	B5	B6	B7	B8	B9	B10	B11	D1
VABM-L1-10AS-M5	85.3	62.6	29.7	18.7	7.7	3	40.3	6.8	24.2	46.7	38.6	M5

Type	D2 ∅	H1	H2	H3	H4	H5	H6	L3	L5	L6	L7	L8	L9
VABM-L1-10AS-M5	4.5	43.8	10	5.5	16.2	6.8	20.3	7	12.5	10.3	10.5	3.5	14

Valve positions	2	3	4	5	6	7	8	9	10	12	14	16
L1	42.5	53	63.5	74	84.5	95	105.5	116	126.5	147.5	168.5	189.5
L2	28.5	39	49.5	60	70.5	81	91.5	102	112.5	133.5	154.5	175.5
L4	35.5	46	56.5	67	77.5	88	98.5	109	119.5	140.5	161.5	182.5
VABM weight [g]	26	34	42	50	58	66	74	82	90	106	122	138



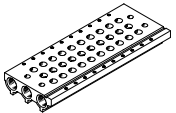

Ordering data

Technical data – Manifold rails	Port	CRC	Material ²⁾	Operating pressure		Max. tightening torque for assembly [Nm]		
	1, 3, 5			[MPa]	[bar]	Valve	H-rail	Wall
	M5	2 ¹⁾	Wrought aluminium alloy	-0.09 ... 1	-0.9 ... 10	0.45	1.5	3

1) Corrosion resistance class CRC 2 to Festo standard FN 940070

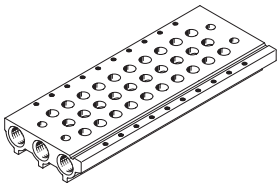
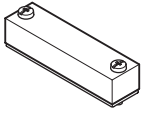
Moderate corrosion stress. Indoor applications in which condensation can occur. External visible parts with primarily decorative surface requirements that are in direct contact with a normal industrial environment.

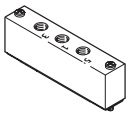
2) Information on materials: RoHS-compliant.

Ordering data – Manifold rail		Description	Part no.	Type
Manifold rail for in-line valves (manifold assembly)				
	For size M3	2 valve positions	566522	VABM-L1-10AS-M5-2
		3 valve positions	566523	VABM-L1-10AS-M5-3
		4 valve positions	566524	VABM-L1-10AS-M5-4
		5 valve positions	566525	VABM-L1-10AS-M5-5
		6 valve positions	566526	VABM-L1-10AS-M5-6
		7 valve positions	566527	VABM-L1-10AS-M5-7
		8 valve positions	566528	VABM-L1-10AS-M5-8
		9 valve positions	566529	VABM-L1-10AS-M5-9
		10 valve positions	566530	VABM-L1-10AS-M5-10
		12 valve positions	566531	VABM-L1-10AS-M5-12
	14 valve positions	566532	VABM-L1-10AS-M5-14	
	16 valve positions	566533	VABM-L1-10AS-M5-16	
Cover plate Datasheets → Internet: vabb				
	For valve position on manifold rail, including screws and seal		569986	VABB-L1-10A
Separator Datasheets → Internet: vabd				
	For creating pressure zones		570872	VABD-4.2-B
Supply plate Datasheets → Internet: vabf				
	For valve position on manifold rail, including screws and seal		569990	VABF-L1-10A-P3A4-M5
Seals for in-line valves Datasheets → Internet: vabd				
	For in-line valves M3	Delivery quantity: 10 sets (each with 2 screws and 1 seal)	566670	VABD-L1-10AX-S-M3

Datasheet

Function

2x 3/2C

5/2-way, single solenoid

5/2-way, double solenoid valve

Circuit diagrams → page 14

-  - Size 10 mm

-  - Flow rate
180 ... 195 l/min

-  - Voltage
24 V DC

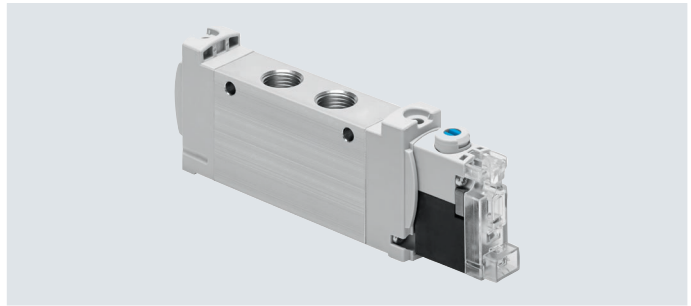

General technical data VUVG-LK

Valve function	T32-A	M52-A	B52	
Normal position	C ¹⁾	–	–	
Stable position	Monostable		Bistable	
Pneumatic spring return	Yes	Yes	–	
Design	Piston spool			
Sealing principle	Soft			
Actuation type	Electrical			
Type of control	Piloted			
Pilot air supply	Internal			
Exhaust air function	Can be throttled			
Manual override	Detenting, non-detenting			
Type of mounting	Optionally via through-holes ²⁾ or on manifold rail			
Mounting position	Any			
Standard nominal flow rate	[l/min]	180	195	195
Switching time on/off	[ms]	12/14	14/17	–
Switching time changeover	[ms]	–		7/8
Size	[mm]	10		
Port	2, 4	M5		
Product weight	[g]	55	45	57
Corrosion resistance class CRC ³⁾		0		
Certificate-issuing authority		UL MH19482		
Certification		c UL us - Recognized (OL)		

1) C = Normally closed

2) If several valves are to be screwed together via the through-holes to form a block, a minimum distance of 0.3 mm must be ensured by inserting spacers

3) More information www.festo.com/x/topic/crc

Safety characteristics

Max. positive test pulse with logic 0	[µs]	1600
Max. negative test pulse with logic 1	[µs]	3000
Shock resistance		Shock test with severity level 1 to FN 942017-5 and EN 60068-2-27
Vibration resistant		Transport application test with severity level 1 to FN 942017-4 and EN 60068-2-6

Datasheet

Operating and environmental conditions			
Valve function		T32-A ¹⁾	M52-A ¹⁾ B52
Operating medium		Compressed air to ISO 8573-2010 [7:4:4]	
Note on the operating/pilot medium		Lubricated operation possible (in which case lubricated operation will always be required)	
Operating pressure	[MPa]	0.15 ... 0.7	0.25 ... 0.7 0.15 ... 0.7
	[bar]	1.5 ... 7	2.5 ... 7 1.5 ... 7
Ambient temperature	[°C]	-5 ... +50	
Temperature of medium	[°C]	-5 ... +50	

1) Pneumatic spring

Electrical data			
Electrical connection		Via E-box → page 113	
Operating voltage	[V DC]	24 ±10%	
Power	[W]	0.7	
Duty cycle	[%]	100	
Protection rating to EN 60529		IP40 (with plug socket), IP65 (with M8)	
Signal status display		LED	
Maximum switching frequency	[Hz]	2	

Information on materials	
Housing	Wrought aluminium alloy
Seals	HNBR, NBR
Note on materials	RoHS-compliant
LABS (PWIS) conformity	VDMA24364 zone III

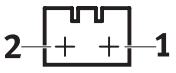
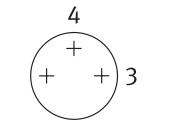
Pin allocation for E-box			
	Pin		Description
Rectangular plug, connection pattern H			
	1	+ or -	Protective circuit without holding current reduction
	2	+ or -	
Round plug, M8, 3-pin			
	1	Not used	Protective circuit without holding current reduction
	3	+ or -	
	4	+ or -	

Protective circuit without holding current reduction

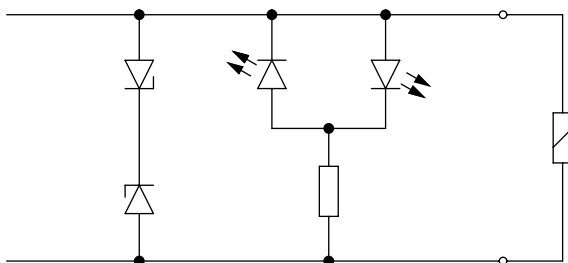

The solenoid coils have a protective circuit to arrest sparks and protect against polarity reversal.

Datasheet

Dimensions

Download CAD data → www.festo.com

2x 3/2-way, 5/2-way valve, double solenoid

5/2-way valve, single solenoid

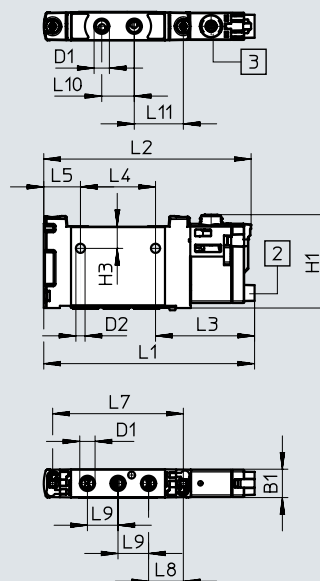
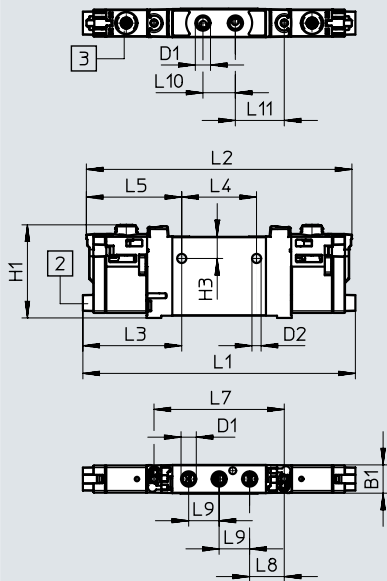

 **Note**
More dimensions for
E-boxes
→ Page 113

[2] Horizontal electrical
connection

[3] Manual override

Type	B1	D1	D2	H1	H3	L1	L2	L3
VUVG-LK10-T32C-...-M5...	10.2	M5	3.3	33.6	7.8	98.3	95.8	35.7
VUVG-LK10-B52-...-M5...								
VUVG-LK10-M52-...-M5...						75.9	74.6	

Type	L4	L5	L7	L8	L9	L10	L11
VUVG-LK10-T32C-...-M5...	27	34.4	47	12.5	11	11.7	17.7
VUVG-LK10-B52-...-M5...							
VUVG-LK10-M52-...-M5...		13.2					

Ordering data

★ Core Range

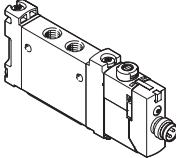
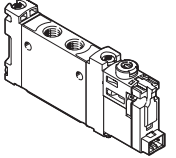
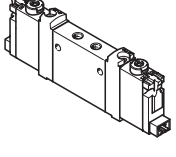
Ordering data			
	Description	Part no.	Type
In-line valve M5, with E-box R8			
	2x 3/2-way valve		
	Internal pilot air supply	Normally closed, pneumatic spring return	★ 8042542 VUVG-LK10-T32C-AT-M5-1R8L-S
	5/2-way valve, single solenoid		
	Internal pilot air supply	Pneumatic spring return	★ 8042543 VUVG-LK10-M52-AT-M5-1R8L-S
	5/2-way valve, double solenoid		
	Internal pilot air supply	★ 8042544 VUVG-LK10-B52-T-M5-1R8L-S	
In-line valve M5, with E-box H2			
	2x 3/2-way valve		
	Internal pilot air supply	Normally closed, pneumatic spring return	★ 8042538 VUVG-LK10-T32C-AT-M5-1H2L-S
	5/2-way valve, single solenoid		
	Internal pilot air supply	Pneumatic spring return	★ 8042539 VUVG-LK10-M52-AT-M5-1H2L-S
	5/2-way valve, double solenoid		
	Internal pilot air supply	★ 8042540 VUVG-LK10-B52-T-M5-1H2L-S	
Ordering data			
	Description	Part no.	Type
In-line valve M5, for battery manufacturing			
	2x 3/2-way valve		
	Internal pilot air supply	Normally closed, pneumatic spring return	8173199 VUVG-LK10-T32C-AT-M5-1H2L-F1A
	5/2-way valve, single solenoid		
	Internal pilot air supply	Pneumatic spring return	8173200 VUVG-LK10-M52-AT-M5-1H2L-F1A
	5/2-way valve, double solenoid		
	Internal pilot air supply	8173201 VUVG-LK10-B52-T-M5-1H2L-F1A	

Datasheet

Function

2x 3/2C

5/2-way, single solenoid

5/2-way, double solenoid valve

Circuit diagrams → page 14

-  - Size 10 mm

-  - Flow rate
280 ... 340 l/min

-  - Voltage
24 V DC

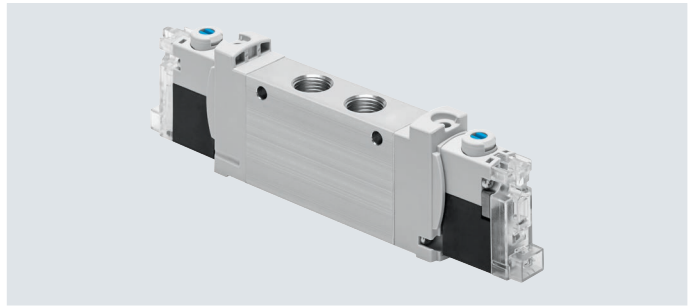

General technical data VUVG-LK

Valve function	T32-A	M52-A	B52	
Normal position	C ¹⁾	-	-	
Stable position	Monostable		Bistable	
Pneumatic spring return	Yes	Yes	-	
Design	Piston spool			
Sealing principle	Soft			
Actuation type	Electrical			
Type of control	Piloted			
Pilot air supply	Internal			
Exhaust air function	Can be throttled			
Manual override	Detenting, non-detenting			
Type of mounting	Optionally via through-holes ²⁾ or on manifold rail			
Mounting position	Any			
Standard nominal flow rate	[l/min]	280	340	340
Switching time on/off	[ms]	12/14	14/17	-
Switching time changeover	[ms]	-		7
Size	[mm]	10		
Port	2, 4	M7		
Product weight	[g]	55	45	57
Corrosion resistance class CRC ³⁾		0		
Certificate-issuing authority		UL MH19482		
Certification		c UL us - Recognized (OL)		

1) C = Normally closed

2) If several valves are to be screwed together via the through-holes to form a block, a minimum distance of 0.3 mm must be ensured by inserting spacers

3) More information www.festo.com/x/topic/crc

Safety characteristics

Max. positive test pulse with logic 0	[µs]	1600
Max. negative test pulse with logic 1	[µs]	3000
Shock resistance		Shock test with severity level 1 to FN 942017-5 and EN 60068-2-27
Vibration resistant		Transport application test with severity level 1 to FN 942017-4 and EN 60068-2-6

Datasheet

Operating and environmental conditions			
Valve function		T32-A ¹⁾	M52-A ¹⁾ B52
Operating medium		Compressed air to ISO 8573-2010 [7:4:4]	
Note on the operating/pilot medium		Lubricated operation possible (in which case lubricated operation will always be required)	
Operating pressure	[MPa]	0.15 ... 0.7	0.25 ... 0.7 0.15 ... 0.7
	[bar]	1.5 ... 7	2.5 ... 7 1.5 ... 7
Ambient temperature	[°C]	-5 ... +50	
Temperature of medium	[°C]	-5 ... +50	

1) Pneumatic spring

Electrical data			
Electrical connection		Via E-box → page 111	
Operating voltage	[V DC]	24 ±10%	
Power	[W]	0.7	
Duty cycle	[%]	100	
Protection rating to EN 60529		IP40 (with plug socket), IP65 (with M8)	
Signal status display		LED	
Maximum switching frequency	[Hz]	2	

Information on materials	
Housing	Wrought aluminium alloy
Seals	HNBR, NBR
Note on materials	RoHS-compliant
LABS (PWIS) conformity	VDMA24364 zone III

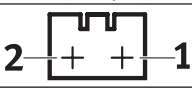
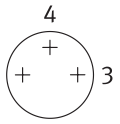
Pin allocation for E-box			
	Pin		Description
Rectangular plug, connection pattern H			
	1	+ or -	Protective circuit without holding current reduction
	2	+ or -	
Round plug, M8, 3-pin			
	1	Not used	Protective circuit without holding current reduction
	3	+ or -	
	4	+ or -	

Protective circuit without holding current reduction

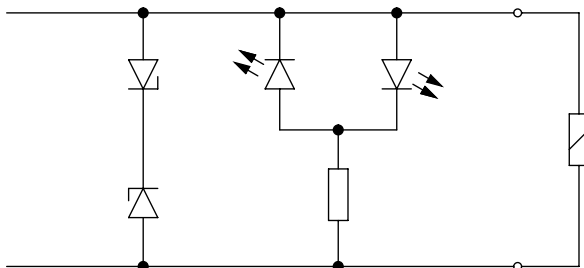

The solenoid coils have a protective circuit to arrest sparks and protect against polarity reversal.

Datasheet

Dimensions

Download CAD data → www.festo.com

2x 3/2-way, 5/2-way valve, double solenoid

5/2-way valve, single solenoid

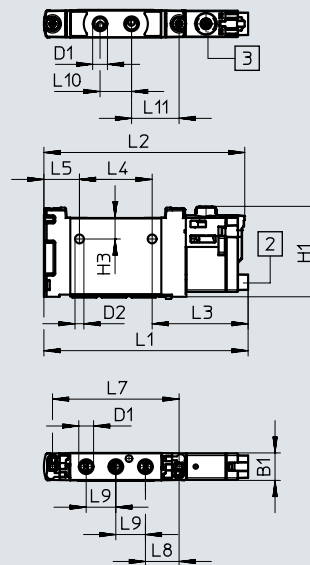
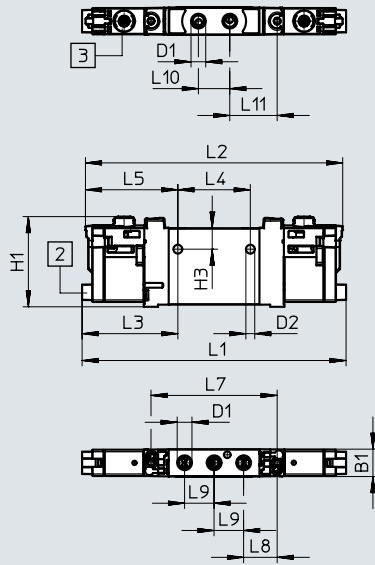

 **Note**
More dimensions for
E-boxes
→ Page 113

[2] Horizontal electrical
connection

[3] Manual override

Type	B1	D1	D2	H1	H3	L1	L2	L3
VUVG-LK10-T32C-...-M7...	10.2	M7	3.3	33.6	7.8	98.3	95.8	35.7
VUVG-LK10-B52-...-M7...						75.9	74.6	35.7
VUVG-LK10-M52-...-M7...								

Type	L4	L5	L7	L8	L9	L10	L11
VUVG-LK10-T32C-...-M7...	27	34.4	47	12.5	11	11.7	17.7
VUVG-LK10-B52-...-M7...		13.2					
VUVG-LK10-M52-...-M7...							

Ordering data

★ Core Range

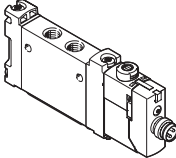
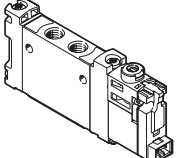
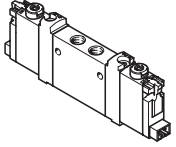

Ordering data			
	Description	Part no.	Type
In-line valve M7, with E-box R8			
	2x 3/2-way valve		
	Internal pilot air supply	Normally closed, pneumatic spring return	★ 8042550 VUVG-LK10-T32C-AT-M7-1R8L-S
	5/2-way valve, single solenoid		
	Internal pilot air supply	Pneumatic spring return	★ 8042551 VUVG-LK10-M52-AT-M7-1R8L-S
	5/2-way valve, double solenoid		
	Internal pilot air supply	★ 8042552 VUVG-LK10-B52-T-M7-1R8L-S	
In-line valve M7, with E-box H2			
	2x 3/2-way valve		
	Internal pilot air supply	Normally closed, pneumatic spring return	★ 8042546 VUVG-LK10-T32C-AT-M7-1H2L-S
	5/2-way valve, single solenoid		
	Internal pilot air supply	Pneumatic spring return	★ 8042547 VUVG-LK10-M52-AT-M7-1H2L-S
	5/2-way valve, double solenoid		
	Internal pilot air supply	★ 8042548 VUVG-LK10-B52-T-M7-1H2L-S	
Ordering data			
	Description	Part no.	Type
In-line valve M7, for battery manufacturing			
	2x 3/2-way valve		
	Internal pilot air supply	Normally closed, pneumatic spring return	8173202 VUVG-LK10-T32C-AT-M7-1H2L-F1A
	5/2-way valve, single solenoid		
	Internal pilot air supply	Pneumatic spring return	8173203 VUVG-LK10-M52-AT-M7-1H2L-F1A
	5/2-way valve, double solenoid		
	Internal pilot air supply	8173204 VUVG-LK10-B52-T-M7-1H2L-F1A	

Solenoid valves VUVG-L10 and VUVG-S10, in-line valves M5

Datasheet

Function

2x 3/2C, 2x 3/2U, 2x 3/2H
 5/2-way, single solenoid
 5/2-way, double solenoid valve
 5/3C, 5/3U, 5/3E

-  - Size 10 mm
-  - Flow rate
125 ... 220 l/min
-  - Voltage
5, 12 and 24 V DC

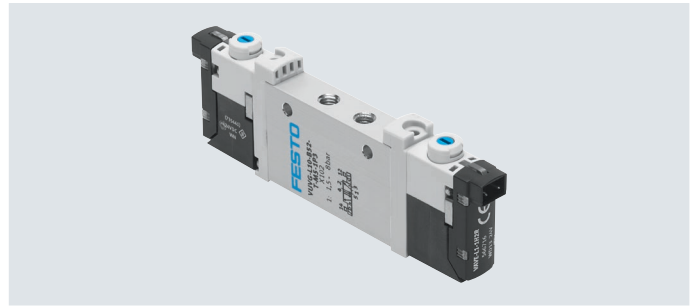

Circuit diagrams → page 14

General technical data VUVG-L M5

Valve function	T32-A			T32-M			M52-R	B52	M52-M	P53		
Normal position	C ¹⁾	U ²⁾	H ⁴⁾	C ¹⁾	U ²⁾	H ⁴⁾	–	–	–	C ¹⁾	U ²⁾	E ³⁾
Stable position	Monostable							Bistable	Monostable	Monostable		
Pneumatic spring return	Yes			No			Yes ⁵⁾	–	No	–		
Mechanical spring return	No			Yes			Yes ⁵⁾	–	Yes	Yes		
Vacuum operation at port 1	No			Only with external pilot air supply								
Design	Piston spool											
Sealing principle	Soft											
Actuation type	Electrical											
Type of control	Piloted											
Pilot air supply	Internal or external											
Exhaust air function	Can be throttled											
Manual override	Choice of non-detenting, covered, non-detenting/detenting or detenting											
Type of mounting	Optionally via through-holes ⁶⁾ or on manifold rail											
Mounting position	Any											
Nominal width [mm]	2.7			1.9		1.8		3.2		2.2		3.2
Standard nominal flow rate [l/min]	150			135		135		220		220		210
Flow rate on manifold rail [l/min]	150			135		125		220		190		210
Switching time on/off [ms]	6/15			8/11			8/17		–	8/24		11/30
Switching time changeover [ms]	–							8		–	14	
Size [mm]	10											
Port	1, 2, 3, 4, 5			M5								
	12/14			M3								
Product weight [g]	55			54			45		55	44		55
Certificate-issuing authority	VUVG-...-F1A			UL MH19482								
Certification	c UL us - Recognized (OL)											
	RCM											
CE marking (see declaration of conformity) ⁷⁾	To EU EMC Directive											
Corrosion resistance class CRC ⁸⁾	2											

1) C=Normally closed/mid-position closed

2) U=Normally open/mid-position pressurised

3) E=Mid-position exhausted

4) H=2x 3/2-way valve in one housing with 1x normally closed and 1x normally open

5) Combined reset method

6) If several valves are to be screwed together via the through-holes to form a block, a minimum distance of 0.3 mm must be ensured by inserting spacers.

7) For information about the area of use, see the EC declaration of conformity at: www.festo.com/catalogue/... → Support/Downloads.

If the devices are subject to usage restrictions in residential, commercial or light-industrial environments, further measures for the reduction of the emitted interference may be necessary.

8) More information www.festo.com/x/topic/crc

Datasheet

Operating and environmental conditions			T32-A ¹⁾	T32-M ³⁾	M52-R ²⁾	B52	M52-M ³⁾	P53	
Valve function			Compressed air to ISO 8573-2010 [7:4:4]						
Operating pressure	Internal	[MPa]	0.15 ... 0.8	0.25 ... 0.8	0.25 ... 0.8	0.15 ... 0.8	0.3 ... 0.8	0.3 ... 0.8	
		[bar]	1.5 ... 8	2.5 ... 8	2.5 ... 8	1.5 ... 8	3 ... 8	3 ... 8	
	External	[MPa]	0.15 ... 1	-0.09 ... 1				-0.09 ... 0.8	-0.09 ... 1
		[bar]	1.5 ... 10	-0.9 ... 10				-0.9 ... 8	-0.9 ... 10
Pilot pressure	[MPa]	0.15 ... 0.8	0.2 ... 0.8	0.25 ... 0.8	0.15 ... 0.8	0.3 ... 0.8			
	[bar]	1.5 ... 8	2 ... 8	2.5 ... 8	1.5 ... 8	3 ... 8			
Ambient temperature		[°C]	-5 ... +50, with holding current reduction -5 ... +60						
Temperature of medium		[°C]	-5 ... +50, with holding current reduction -5 ... +60						

- 1) Pneumatic spring
2) Combined pneumatic/mechanical spring
3) Mechanical spring

Electrical data		
Electrical connection		Via E-box → page 111
Operating voltage	[V DC]	5, 12 and 24 ±10%
Power	[W]	1, reduced to 0.35 with holding current reduction
Duty cycle	[%]	100
Protection rating to EN 60529		IP40 (with plug socket), IP65 (with M8)

Information on materials	
Housing	Wrought aluminium alloy
Seals	HNBR, NBR
Note on materials	RoHS-compliant
LABS (PWIS) conformity	VDMA24364-B1/B2-L

Datasheet

Dimensions

Download CAD data → www.festo.com

2x 3/2-way, 5/2-way and 5/3-way valve

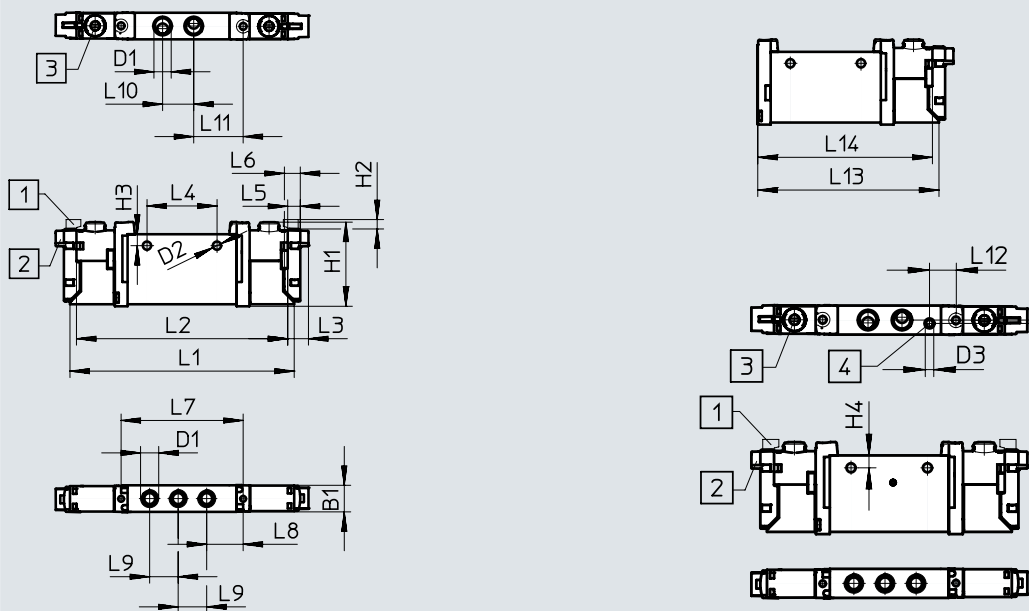

[1] Vertical electrical connection

[2] Horizontal electrical connection

[3] Manual override

[4] Port for external pilot air supply

Type	B1	B2	D1	D2	D3	H1	H2	H3	L1	L2	L3	L4
VUVG-L-10 -...-M5...	10.2	-	M5	3.2	M3	32.5	3.6	4.4	86.5	81.5	8	27
VUVG-S-10 -...-M5...												

Type	L5	L6	L7	L8	L9	L10	L11	L12	L13	L14
VUVG-L-10 -...-M5...	4.85	6.15	47	14	11	12	19	-	69.2	66.7
VUVG-S-10 -...-M5...										

Ordering data

★ Core Range

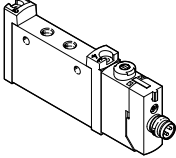
Ordering data		Description	Part no.	Type
In-line valve M5, with E-box R8				
	5/3-way valve			
	Internal pilot air supply	Mid-position closed, mechanical spring return	★ 577346	VUVG-L10-P53C-T-M5-1R8L

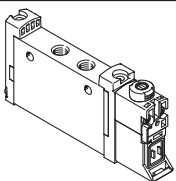
Ordering data		Description	Part no.	Type	
In-line valve M5, without E-box					
	2x 3/2-way valve				
	Internal pilot air supply	Normally closed, pneumatic spring return	566454	VUVG-L10-T32C-AT-M5-1P3	
		Normally open, pneumatic spring return	566455	VUVG-L10-T32U-AT-M5-1P3	
		1x normally open, 1x normally closed, pneumatic spring return	566456	VUVG-L10-T32H-AT-M5-1P3	
		Normally closed, mechanical spring return	574348	VUVG-L10-T32C-MT-M5-1P3	
		Normally open, mechanical spring return	574349	VUVG-L10-T32U-MT-M5-1P3	
		1x normally open, 1x normally closed, mechanical spring return	574350	VUVG-L10-T32H-MT-M5-1P3	
	External pilot air supply	Normally closed, pneumatic spring return	566463	VUVG-L10-T32C-AZT-M5-1P3	
		Normally open, pneumatic spring return	566464	VUVG-L10-T32U-AZT-M5-1P3	
		1x normally open, 1x normally closed, pneumatic spring return	566465	VUVG-L10-T32H-AZT-M5-1P3	
		Normally closed, mechanical spring return	574352	VUVG-L10-T32C-MZT-M5-1P3	
		Normally open, mechanical spring return	574353	VUVG-L10-T32U-MZT-M5-1P3	
		1x normally open, 1x normally closed, mechanical spring return	574354	VUVG-L10-T32H-MZT-M5-1P3	
	5/2-way valve, single solenoid				
	Internal pilot air supply	Pneumatic/mechanical spring return	566457	VUVG-L10-M52-RT-M5-1P3	
Mechanical spring return		574351	VUVG-L10-M52-MT-M5-1P3		
External pilot air supply	Pneumatic/mechanical spring return	566466	VUVG-L10-M52-RZT-M5-1P3		
	Mechanical spring return	574355	VUVG-L10-M52-MZT-M5-1P3		

Ordering data

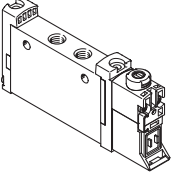
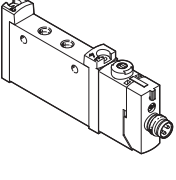
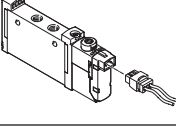
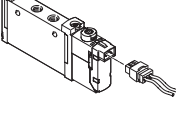
Ordering data		Description	Part no.	Type
In-line valve M5, without E-box				
	5/2-way valve, double solenoid			
	Internal pilot air supply		566458	VUVG-L10-B52-T-M5-1P3
	External pilot air supply		566467	VUVG-L10-B52-ZT-M5-1P3
	5/3-way valve			
	Internal pilot air supply	Mid-position closed, mechanical spring return	566459	VUVG-L10-P53C-T-M5-1P3
		Mid-position exhausted, mechanical spring return	566460	VUVG-L10-P53E-T-M5-1P3
		Mid-position pressurised, mechanical spring return	566461	VUVG-L10-P53U-T-M5-1P3
	External pilot air supply	Mid-position closed, mechanical spring return	566468	VUVG-L10-P53C-ZT-M5-1P3
		Mid-position exhausted, mechanical spring return	566469	VUVG-L10-P53E-ZT-M5-1P3
Mid-position pressurised, mechanical spring return		566470	VUVG-L10-P53U-ZT-M5-1P3	
In-line valve M5, with E-box R8				
	2x 3/2-way valve			
	Internal pilot air supply	Normally closed, pneumatic spring return	577347	VUVG-L10-T32C-AT-M5-1R8L
		Normally open, pneumatic spring return	8031466	VUVG-L10-T32U-AT-M5-1R8L
		1x normally open, 1x normally closed, pneumatic spring return	8031467	VUVG-L10-T32H-AT-M5-1R8L
		Normally closed, mechanical spring return	8031468	VUVG-L10-T32C-MT-M5-1R8L
		Normally open, mechanical spring return	8031469	VUVG-L10-T32U-MT-M5-1R8L
		1x normally open, 1x normally closed, mechanical spring return	8031470	VUVG-L10-T32H-MT-M5-1R8L
	5/2-way valve, single solenoid			
	Internal pilot air supply	Pneumatic/mechanical spring return	572634	VUVG-L10-M52-RT-M5-1R8L
		Mechanical spring return	8031472	VUVG-L10-M52-MT-M5-1R8L
	5/2-way valve, double solenoid			
	Internal pilot air supply		576664	VUVG-L10-B52-T-M5-1R8L
	5/3-way valve			
	Internal pilot air supply	Mid-position exhausted, mechanical spring return	8031475	VUVG-L10-P53E-T-M5-1R8L
		Mid-position pressurised, mechanical spring return	8031476	VUVG-L10-P53U-T-M5-1R8L
In-line valve M5, with E-box H2				
	5/2-way valve, single solenoid			
	Internal pilot air supply	Pneumatic/mechanical spring return	577316	VUVG-L10-M52-RT-M5-1H2L-W1
		Mechanical spring return	578162	VUVG-L10-M52-MT-M5-1H2L-W1
	5/2-way valve, double solenoid			
Internal pilot air supply		577317	VUVG-L10-B52-T-M5-1H2L-W1	
Semi in-line valve M5, with E-box H2				
	5/2-way valve, single solenoid			
	Internal pilot air supply	Pneumatic/mechanical spring return	577324	VUVG-S10-M52-RT-M5-1H2L-W1

Ordering data

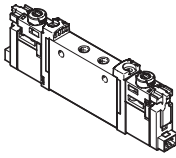

Ordering data	Description	Part no.	Type	
In-line valve M5, for battery manufacturing				
	2x 3/2-way valve			
	Internal pilot air supply	Normally closed, mechanical spring return	8164322	VUVG-L10-T32C-MT-M5-1H2L-F1A
		Normally open, pneumatic spring return	8164323	VUVG-L10-T32U-AT-M5-1H2L-F1A
		Normally open, mechanical spring return	8164324	VUVG-L10-T32U-MT-M5-1H2L-F1A
		1x normally open, 1x normally closed, pneumatic spring return	8164325	VUVG-L10-T32H-AT-M5-1H2L-F1A
		1x normally open, 1x normally closed, mechanical spring return	8164326	VUVG-L10-T32H-MT-M5-1H2L-F1A
	External pilot air supply	Normally closed, pneumatic spring return	8164331	VUVG-L10-T32C-AZT-M5-1H2L-F1A
		Normally closed, mechanical spring return	8164332	VUVG-L10-T32C-MZT-M5-1H2L-F1A
		Normally open, pneumatic spring return	8164333	VUVG-L10-T32U-AZT-M5-1H2L-F1A
		Normally open, mechanical spring return	8164334	VUVG-L10-T32U-MZT-M5-1H2L-F1A
		1x normally open, 1x normally closed, pneumatic spring return	8164335	VUVG-L10-T32H-AZT-M5-1H2L-F1A
		1x normally open, 1x normally closed, mechanical spring return	8164336	VUVG-L10-T32H-MZT-M5-1H2L-F1A
	5/2-way valve, single solenoid			
	Internal pilot air supply	Mechanical spring return	8164327	VUVG-L10-M52-MT-M5-1H2L-F1A
	External pilot air supply	Pneumatic/mechanical spring return	8164337	VUVG-L10-M52-RZT-M5-1H2L-F1A
		Mechanical spring return	8164338	VUVG-L10-M52-MZT-M5-1H2L-F1A
	5/2-way valve, double solenoid			
	External pilot air supply		8164339	VUVG-L10-B52-ZT-M5-1H2L-F1A
5/3-way valve				
Internal pilot air supply	Mid-position closed	8164328	VUVG-L10-P53C-T-M5-1H2L-F1A	
	Mid-position exhausted	8164329	VUVG-L10-P53E-T-M5-1H2L-F1A	
	Mid-position pressurised	8164330	VUVG-L10-P53U-T-M5-1H2L-F1A	
External pilot air supply	Mid-position closed	8164340	VUVG-L10-P53C-ZT-M5-1H2L-F1A	
	Mid-position exhausted	8164341	VUVG-L10-P53E-ZT-M5-1H2L-F1A	
	Mid-position pressurised	8164342	VUVG-L10-P53U-ZT-M5-1H2L-F1A	

Solenoid valves VUVG-L10 and VUVG-S10, in-line valves M7

Datasheet

Function

2x 3/2C, 2x 3/2U, 2x 3/2H
 5/2-way, single solenoid
 5/2-way, double solenoid valve
 5/3C, 5/3U, 5/3E

-  - Size 10 mm
-  - Flow rate
130 ... 380 l/min
-  - Voltage
5, 12 and 24 V DC

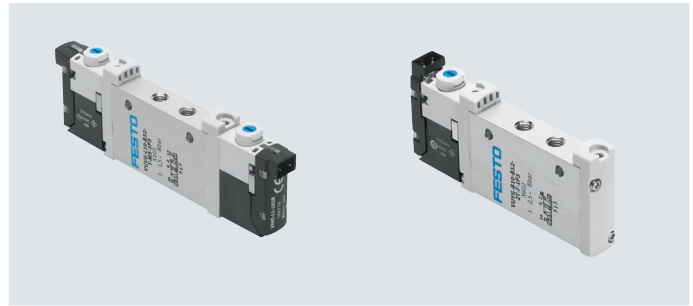

Circuit diagrams → page 14

General technical data VUVG-L M7

Valve function	T32-A			T32-M			M52-R	B52	M52-M	P53				
	C ¹⁾	U ²⁾	H ⁴⁾	C ¹⁾	U ²⁾	H ⁴⁾	–	–	–	C ¹⁾	U ²⁾	E ³⁾		
Normal position	C ¹⁾	U ²⁾	H ⁴⁾	C ¹⁾	U ²⁾	H ⁴⁾	–	–	–	C ¹⁾	U ²⁾	E ³⁾		
Stable position	Monostable							Bistable	Monostable	Monostable				
Pneumatic spring return	Yes			No			Yes ⁵⁾	–	No	–				
Mechanical spring return	No			Yes			Yes ⁵⁾	–	Yes	Yes				
Vacuum operation at port 1	No			Only with external pilot air supply										
Design	Piston spool													
Sealing principle	Soft													
Actuation type	Electrical													
Type of control	Piloted													
Pilot air supply	Internal or external													
Exhaust air function	Can be throttled													
Manual override	Choice of non-detenting, covered, non-detenting/detenting or detenting													
Type of mounting	Optionally via through-holes ⁶⁾ or on manifold rail													
Mounting position	Any													
Nominal width [mm]	2.7			2.0		1.9		1.9		4.0		2.8		3.5
Standard nominal flow rate [l/min]	190			155		155		155		330		380		320
Flow rate on manifold rail [l/min]	170			140		130		130		320		340		290
Switching time on/off [ms]	6/15			8/11			7/17			–		8/24		11/30
Switching time changeover [ms]	–			–			–			7		–		14
Size [mm]	10													
Port	1, 2, 3, 4, 5			M7										
	12/14			M3										
Product weight [g]	55			54			45		55		44		55	
Certificate-issuing authority	VUVG-...-F1A			UL MH19482										
Certification	c UL us - Recognized (OL)													
	RCM													
CE marking (see declaration of conformity) ⁷⁾	To EU EMC Directive													
Corrosion resistance class CRC ⁸⁾	2													

- 1) C=Normally closed/mid-position closed
- 2) U=Normally open/mid-position pressurised
- 3) E=Mid-position exhausted
- 4) H=2x 3/2-way valve in one housing with 1x normally closed and 1x normally open
- 5) Combined reset method
- 6) If several valves are to be screwed together via the through-holes to form a block, a minimum distance of 0.3 mm must be ensured by inserting spacers.
- 7) For information about the area of use, see the EC declaration of conformity at: www.festo.com/catalogue/... → Support/Downloads.
If the devices are subject to usage restrictions in residential, commercial or light-industrial environments, further measures for the reduction of the emitted interference may be necessary.
- 8) More information www.festo.com/x/topic/crc

Datasheet

Operating and environmental conditions			T32-A ¹⁾	T32-M ³⁾	M52-R ²⁾	B52	M52-M ³⁾	P53	
Valve function			Compressed air to ISO 8573-2010 [7:4:4]						
Operating pressure	Internal	[MPa]	0.15 ... 0.8	0.25 ... 0.8	0.25 ... 0.8	0.15 ... 0.8	0.3 ... 0.8		
		[bar]	1.5 ... 8	2.5 ... 8	2.5 ... 8	1.5 ... 8	3 ... 8		
	External	[MPa]	0.15 ... 1	-0.09 ... 1				-0.09 ... 0.8	-0.09 ... 1
		[bar]	1.5 ... 10	-0.9 ... 10				-0.9 ... 8	-0.9 ... 10
Pilot pressure	[MPa]	0.15 ... 0.8	0.2 ... 0.8	0.25 ... 0.8	0.15 ... 0.8	0.3 ... 0.8	0.3 ... 0.8		
	[bar]	1.5 ... 8	2 ... 8	2.5 ... 8	1.5 ... 8	3 ... 8	3 ... 8		
Ambient temperature		[°C]	-5 ... +50, with holding current reduction -5 ... +60						
Temperature of medium		[°C]	-5 ... +50, with holding current reduction -5 ... +60						

- 1) Pneumatic spring
2) Combined pneumatic/mechanical spring
3) Mechanical spring

Electrical data	
Electrical connection	Via E-box → page 111
Operating voltage [V DC]	5, 12, 24 ±10%
Power [W]	1, reduced to 0.35 with holding current reduction
Duty cycle [%]	100
Protection rating to EN 60529	IP40 (with plug socket), IP65 (with M8)

Information on materials	
Housing	Wrought aluminium alloy
Seals	HNBR, NBR
Note on materials	RoHS-compliant
LABS (PWIS) conformity	VDMA24364-B1/B2-L

Datasheet

Dimensions

Download CAD data → www.festo.com

2x 3/2-way, 5/2-way and 5/3-way valve

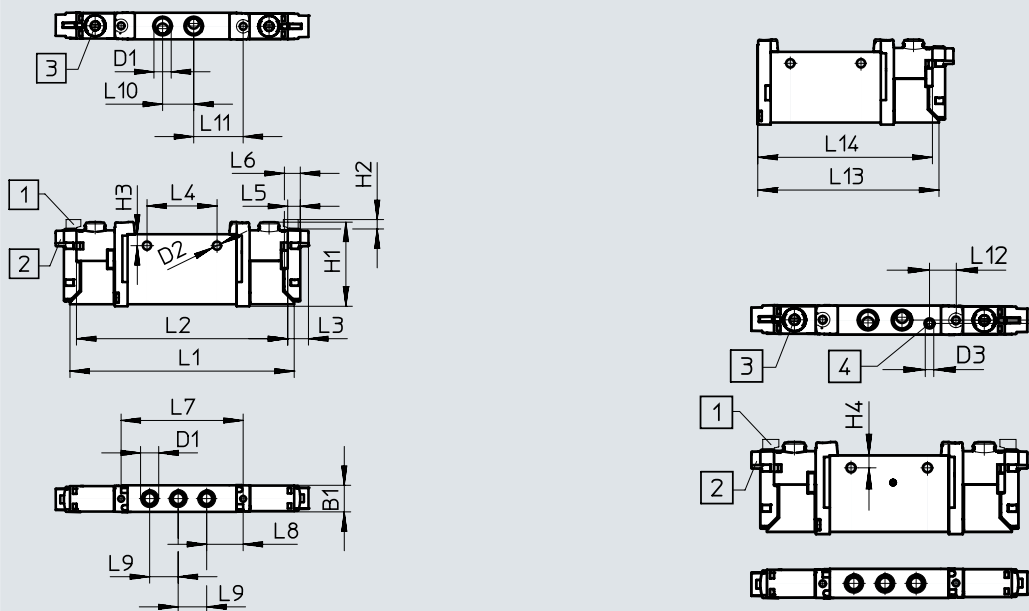

Note
 More dimensions for
 E-boxes
 → Page 113

- [1] Vertical electrical connection
- [2] Horizontal electrical connection
- [3] Manual override
- [4] Port for external pilot air supply

Type	B1	B2	D1	D2	D3	H1	H2	H3	L1	L2	L3	L4
VUVG-L-10 -...-M7...	10.2	-	M7	3.2	M3	32.5	3.6	4.4	86.5	81.5	8	27
VUVG-S-10 -...-M7...												

Type	L5	L6	L7	L8	L9	L10	L11	L12	L13	L14
VUVG-L-10 -...-M7...	4.85	6.15	47	14	11	12	19	-	69.2	66.7
VUVG-S-10 -...-M7...										

Ordering data

★ Core Range

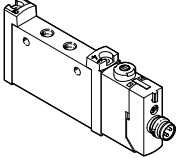
Ordering data		Description	Part no.	Type
In-line valve M7, with E-box R8				
	5/3-way valve			
	Internal pilot air supply	Mid-position closed, mechanical spring return	★ 574223	VUVG-L10-P53C-T-M7-1R8L

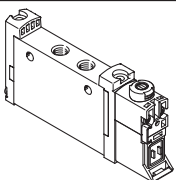
Ordering data		Description	Part no.	Type
In-line valve M7, without E-box				
	2x 3/2-way valve			
	Internal pilot air supply	Normally closed, pneumatic spring return	566471	VUVG-L10-T32C-AT-M7-1P3
		Normally open, pneumatic spring return	566472	VUVG-L10-T32U-AT-M7-1P3
		1x normally open, 1x normally closed, pneumatic spring return	566473	VUVG-L10-T32H-AT-M7-1P3
		Normally closed, mechanical spring return	574356	VUVG-L10-T32C-MT-M7-1P3
		Normally open, mechanical spring return	574357	VUVG-L10-T32U-MT-M7-1P3
		1x normally open, 1x normally closed, mechanical spring return	574358	VUVG-L10-T32H-MT-M7-1P3
	External pilot air supply	Normally closed, pneumatic spring return	566479	VUVG-L10-T32C-AZT-M7-1P3
		Normally open, pneumatic spring return	566480	VUVG-L10-T32U-AZT-M7-1P3
		1x normally open, 1x normally closed, pneumatic spring return	566481	VUVG-L10-T32H-AZT-M7-1P3
		Normally closed, mechanical spring return	574360	VUVG-L10-T32C-MZT-M7-1P3
		Normally open, mechanical spring return	574361	VUVG-L10-T32U-MZT-M7-1P3
		Normally closed, mechanical spring return	574362	VUVG-L10-T32H-MZT-M7-1P3

Ordering data

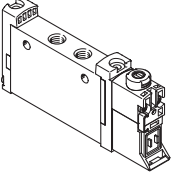
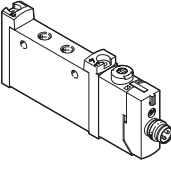
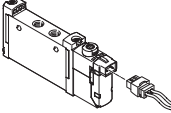
Ordering data		Description	Part no.	Type
In-line valve M7, without E-box				
	5/2-way valve, single solenoid			
	Internal pilot air supply	Mechanical spring return	574359	VUVG-L10-M52-MT-M7-1P3
		Pneumatic/mechanical spring return	566474	VUVG-L10-M52-RT-M7-1P3
	External pilot air supply	Mechanical spring return	574363	VUVG-L10-M52-MZT-M7-1P3
		Pneumatic/mechanical spring return	566482	VUVG-L10-M52-RZT-M7-1P3
	5/2-way valve, double solenoid			
	Internal pilot air supply		566475	VUVG-L10-B52-T-M7-1P3
	External pilot air supply		566483	VUVG-L10-B52-ZT-M7-1P3
	5/3-way valve			
	Internal pilot air supply	Mid-position closed, mechanical spring return	566476	VUVG-L10-P53C-T-M7-1P3
Mid-position exhausted, mechanical spring return		566477	VUVG-L10-P53E-T-M7-1P3	
Mid-position pressurised, mechanical spring return		566478	VUVG-L10-P53U-T-M7-1P3	
External pilot air supply	Mid-position closed, mechanical spring return	566484	VUVG-L10-P53C-ZT-M7-1P3	
	Mid-position exhausted, mechanical spring return	566485	VUVG-L10-P53E-ZT-M7-1P3	
	Mid-position pressurised, mechanical spring return	566486	VUVG-L10-P53U-ZT-M7-1P3	
In-line valve M7, with E-box R8				
	2x 3/2-way valve			
	Internal pilot air supply	Normally closed, pneumatic spring return	574218	VUVG-L10-T32C-AT-M7-1R8L
		Normally open, pneumatic spring return	574219	VUVG-L10-T32U-AT-M7-1R8L
		1x normally open, 1x normally closed, pneumatic spring return	574220	VUVG-L10-T32H-AT-M7-1R8L
		Normally closed, mechanical spring return	8031480	VUVG-L10-T32C-MT-M7-1R8L
		Normally open, mechanical spring return	8031481	VUVG-L10-T32U-MT-M7-1R8L
		1x normally open, 1x normally closed, mechanical spring return	8031482	VUVG-L10-T32H-MT-M7-1R8L
	5/2-way valve, single solenoid			
	Internal pilot air supply	Pneumatic/mechanical spring return	574221	VUVG-L10-M52-RT-M7-1R8L
		Mechanical spring return	8031485	VUVG-L10-M52-MT-M7-1R8L
5/2-way valve, double solenoid				
Internal pilot air supply		574222	VUVG-L10-B52-T-M7-1R8L	
5/3-way valve				
Internal pilot air supply	Mid-position exhausted, mechanical spring return	574225	VUVG-L10-P53E-T-M7-1R8L	
	Mid-position pressurised, mechanical spring return	574224	VUVG-L10-P53U-T-M7-1R8L	
In-line valve M7, with E-box H2				
	5/2-way valve, single solenoid			
	Internal pilot air supply	Pneumatic/mechanical spring return	577333	VUVG-L10-M52-RT-M7-1H2L-W1
		Mechanical spring return	578163	VUVG-L10-M52-MT-M7-1H2L-W1
5/2-way valve, double solenoid				
Internal pilot air supply		577332	VUVG-L10-B52-T-M7-1H2L-W1	

Ordering data

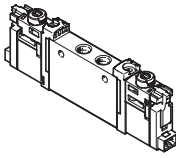
Ordering data	Description	Part no.	Type	
In-line valve M7, for battery manufacturing				
	2x 3/2-way valve			
	Internal pilot air supply	Normally closed, mechanical spring return	8164343	VUVG-L10-T32C-MT-M7-1H2L-F1A
		Normally open, pneumatic spring return	8164344	VUVG-L10-T32U-AT-M7-1H2L-F1A
		Normally open, mechanical spring return	8164345	VUVG-L10-T32U-MT-M7-1H2L-F1A
		1x normally open, 1x normally closed, pneumatic spring return	8154346	VUVG-L10-T32H-AT-M7-1H2L-F1A
		1x normally open, 1x normally closed, mechanical spring return	8164347	VUVG-L10-T32H-MT-M7-1H2L-F1A
	External pilot air supply	Normally closed, pneumatic spring return	8164352	VUVG-L10-T32C-AZT-M7-1H2L-F1A
		Normally closed, mechanical spring return	8164353	VUVG-L10-T32C-MZT-M7-1H2L-F1A
		Normally open, pneumatic spring return	8164354	VUVG-L10-T32U-AZT-M7-1H2L-F1A
		Normally open, mechanical spring return	8164355	VUVG-L10-T32U-MZT-M7-1H2L-F1A
		1x normally open, 1x normally closed, pneumatic spring return	8164356	VUVG-L10-T32H-AZT-M7-1H2L-F1A
		1x normally open, 1x normally closed, mechanical spring return	8164357	VUVG-L10-T32H-MZT-M7-1H2L-F1A
	5/2-way valve, single solenoid			
	Internal pilot air supply	Mechanical spring return	8164348	VUVG-L10-M52-MT-M7-1H2L-F1A
	External pilot air supply	Pneumatic/mechanical spring return	8164358	VUVG-L10-M52-RZT-M7-1H2L-F1A
		Mechanical spring return	8164359	VUVG-L10-M52-MZT-M7-1H2L-F1A
5/2-way valve, double solenoid				
External pilot air supply		8164360	VUVG-L10-B52-ZT-M7-1H2L-F1A	
5/3-way valve				
Internal pilot air supply	Mid-position closed	8164349	VUVG-L10-P53C-T-M7-1H2L-F1A	
	Mid-position exhausted	8164350	VUVG-L10-P53E-T-M7-1H2L-F1A	
	Mid-position pressurised	8164351	VUVG-L10-P53U-T-M7-1H2L-F1A	
External pilot air supply	Mid-position closed	8164361	VUVG-L10-P53C-ZT-M7-1H2L-F1A	
	Mid-position exhausted	8164362	VUVG-L10-P53E-ZT-M7-1H2L-F1A	
	Mid-position pressurised	8164363	VUVG-L10-P53U-ZT-M7-1H2L-F1A	

Manifold assembly

In-line valves for manifold assembly

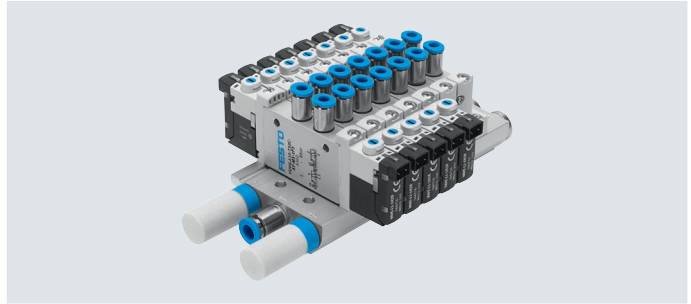

Dimensions

Download CAD data → www.festo.com

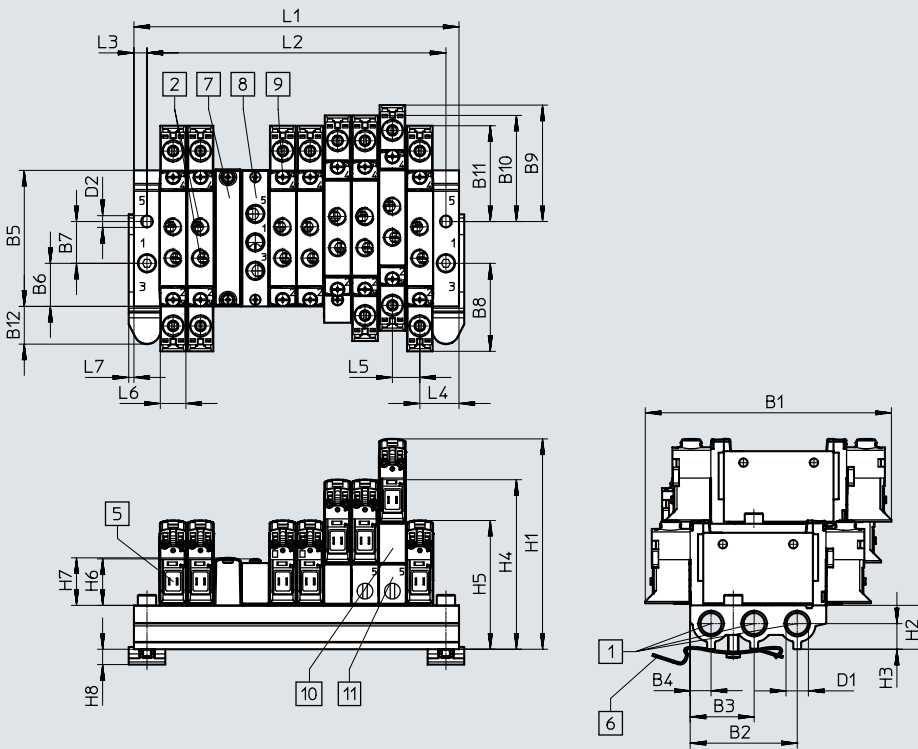

Note
 More dimensions for
 E-boxes
 → Page 113

- | | | | |
|-------------------------------------------------------|------------------------------------------------------------------|-------------------------------------------------------------|--------------------------------------|
| [1] Ports 1, 3 and 5: G1/8 | [6] H-rail mounting (two M4x20 screws are required for mounting) | [8] Supply plate | [10] Vertical pressure supply plate |
| [2] Ports 1, 2, 3, 4 and 5 on the valve: M7 or M5 | [7] Cover plate | [9] Valves/cover plate mounting on manifold rail: M2 thread | [11] Vertical pressure exhaust plate |
| [5] Electrical connection for E-boxes and accessories | | | |

Type	B1	B2	B3	B4	B5	B6	B7	B8	B9	B10	B11	B12	D1	D2
VABML-L1-10S-G18	94.3	41	24.5	8	52.1	16.5	16	33.7	44.6	40.7	36.7	14.4	G1/8	4.5

Type	D5	H1	H2	H3	H4	H5	H6	H7	H8	L3	L4	L5	L6	L7
VABML-L1-10S-G18	8	80.6	16.8	9.8	64.9	49.3	17.8	18	5.9	5	15	10.5	10.3	2

Valve positions	2	3	4	5	6	7	8	9	10	12	14	16	22
L1	40.5	51	61.5	72	82.5	93	103.5	114	124.5	145.5	166.5	187.5	250.5
L2	30.5	41	51.5	62	72.5	83	93.5	104	114.5	135.5	156.5	177.5	240.5
VABM weight [g]	63	78	93	108	123	138	153	168	183	213	243	273	363



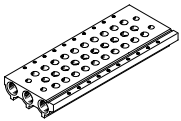

Ordering data

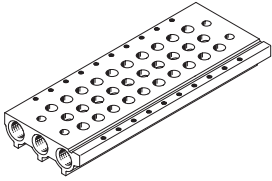
Technical data – Manifold rails								
	Port	CRC	Material ²⁾	Operating pressure		Max. tightening torque for assembly [Nm]		
	1, 3, 5			[MPa]	[bar]	Valve	H-rail	Wall
	G1/8	2 ¹⁾	Wrought aluminium alloy	0.15 ... 0.8	1.5 ... 8	0.45	1.5	3

- 1) Corrosion resistance class CRC 2 to Festo standard FN 940070
Moderate corrosion stress. Indoor applications in which condensation can occur. External visible parts with primarily decorative surface requirements that are in direct contact with a normal industrial environment.
- 2) Information on materials: RoHS-compliant.

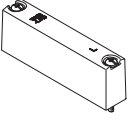
Ordering data – Manifold rail			
	Description	Part no.	Type
Manifold rail for in-line valve (manifold assembly)			
	For size M5/M7	2 valve positions	★ 566558 VABM-L1-10S-G18-2
		3 valve positions	★ 566559 VABM-L1-10S-G18-3
		4 valve positions	★ 566560 VABM-L1-10S-G18-4
		5 valve positions	566561 VABM-L1-10S-G18-5
		6 valve positions	★ 566562 VABM-L1-10S-G18-6
		7 valve positions	566563 VABM-L1-10S-G18-7
		8 valve positions	★ 566564 VABM-L1-10S-G18-8
		9 valve positions	566565 VABM-L1-10S-G18-9
		10 valve positions	★ 566566 VABM-L1-10S-G18-10
		12 valve positions	566567 VABM-L1-10S-G18-12
		14 valve positions	566568 VABM-L1-10S-G18-14
		16 valve positions	566569 VABM-L1-10S-G18-16

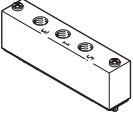
Ordering data

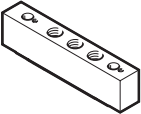
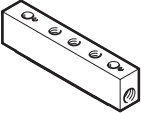
Ordering data – Accessories					
Description		Part no.	Type		
Cover plate Datasheets → Internet: vabb					
	For valve position on manifold rail, including screws and seal	–	★ 566462	VABB-L1-10-S	
		Suitable for battery manufacturing	8168538	VABB-L1-10-F1A	
Separator Datasheets → Internet: vabd					
	For creating pressure zones		569995	VABD-8-B	
Supply plate Datasheets → Internet: vabf					
	For valve position (in-line valves M5) on manifold rail, including screws and seal	–	569991	VABF-L1-10-P3A4-M5	
		Suitable for battery manufacturing	8163542	VABF-L1-10-P3A4-M5-F1A	
	For valve position (in-line valves M7) on manifold rail, including screws and seal	–	569992	VABF-L1-10-P3A4-M7	
		Suitable for battery manufacturing	8163543	VABF-L1-10-P3A4-M7-F1A	
Seals Datasheets → Internet: vabd					
	In-line valves VUVG-LK				
	For in-line valves M5	Delivery quantity: 10 sets (each with 2 screws and 1 seal)	–	★ 8043718	VABD-L1-10XK-S-M5-S
			Suitable for battery manufacturing	8168885	VABD-L1-10XK-S-M5-F1A
	For in-line valves M7		–	★ 8043719	VABD-L1-10XK-S-M7-S
			Suitable for battery manufacturing	8168884	VABD-L1-10XK-S-M7-F1A
	In-line valves VUVG-L				
	For in-line valves M5	Delivery quantity: 10 sets (each with 2 screws and 1 seal)	–	★ 566672	VABD-L1-10X-S-M5
			Suitable for battery manufacturing	8168587	VABD-L1-10X-S-M5-F1A
For in-line valves M7		–	★ 566673	VABD-L1-10X-S-M7	
		Suitable for battery manufacturing	8168588	VABD-L1-10X-S-M7-F1A	
Vertical pressure supply plate					
	Pneumatic connection 1: M7	Terminal code CP	574592	VABF-L1-P3A3-M7	
Vertical pressure exhaust plate					
	Pneumatic connection 3, 5: M7	Terminal code CR	574594	VABF-L1-P7A13-M7	

Datasheet

Function

2x 3/2C

5/2-way, single solenoid

5/2-way, double solenoid valve

Circuit diagrams → page 14

-  - Size 14 mm

-  - Flow rate
570 ... 660 l/min

-  - Voltage
24 V DC

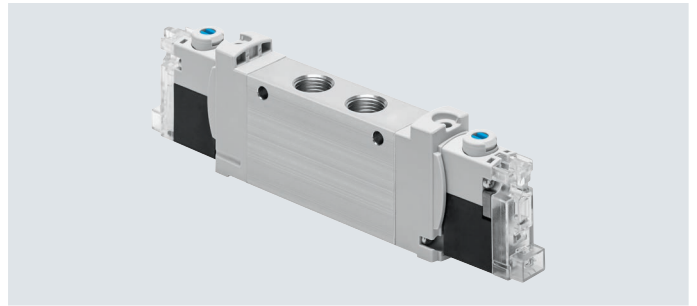

General technical data VUVG-LK

Valve function	T32-A	M52-A	B52	
Normal position	C ¹⁾	–	–	
Stable position	Monostable		Bistable	
Pneumatic spring return	Yes	Yes	–	
Design	Piston spool			
Sealing principle	Soft			
Actuation type	Electrical			
Type of control	Piloted			
Pilot air supply	Internal			
Exhaust air function	Can be throttled			
Manual override	Non-detenting, detenting			
Type of mounting	Optionally via through-holes ²⁾ or on manifold rail			
Mounting position	Any			
Standard nominal flow rate	[l/min]	570	660	660
Switching time on/off	[ms]	13/20	14/24	–
Switching time changeover	[ms]	–		8
Size	[mm]	14		
Port	2, 4	G1/8		
Product weight	[g]	75	65	85
Corrosion resistance class CRC ³⁾		0		
Certificate-issuing authority		UL MH19482		
Certification		c UL us - Recognized (OL)		

1) C = Normally closed

2) If several valves are to be screwed together via the through-holes to form a block, a minimum distance of 0.3 mm must be ensured by inserting spacers

3) More information www.festo.com/x/topic/crc

Safety characteristics

Max. positive test pulse with logic 0	[μs]	1600
Max. negative test pulse with logic 1	[μs]	3000
Shock resistance		Shock test with severity level 1 to FN 942017-5 and EN 60068-2-27
Vibration resistant		Transport application test with severity level 1 to FN 942017-4 and EN 60068-2-6

Datasheet

Operating and environmental conditions			
Valve function		T32-A ¹⁾	M52-A ¹⁾ B52
Operating medium		Compressed air to ISO 8573-2010 [7:4:4]	
Note on the operating/pilot medium		Lubricated operation possible (in which case lubricated operation will always be required)	
Operating pressure	[MPa]	0.15 ... 0.7	0.25 ... 0.7
	[bar]	1.5 ... 7	2.5 ... 7
Ambient temperature	[°C]	-5 ... +50	
Temperature of medium	[°C]	-5 ... +50	

1) Pneumatic spring

Electrical data	
Electrical connection	Via E-box → page 111
Operating voltage	[V DC] 5, 12, 24 ±10%
Power	[W] 1, reduced to 0.35 with holding current reduction
Duty cycle	[%] 100
Protection rating to EN 60529	IP40 (with plug socket), IP65 (with M8)

Information on materials	
Housing	Wrought aluminium alloy
Seals	HNBR, NBR
Note on materials	RoHS-compliant
LABS (PWIS) conformity	VDMA24364 zone III

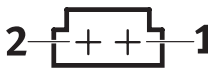
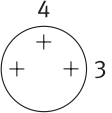
Pin allocation for E-box			Pin	Description
Rectangular plug, connection pattern H				
	1	+ or -		Protective circuit without holding current reduction
	2	+ or -		
Round plug, M8, 3-pin				
	1	Not used		Protective circuit without holding current reduction
	3	+ or -		
	4	+ or -		

Protective circuit without holding current reduction

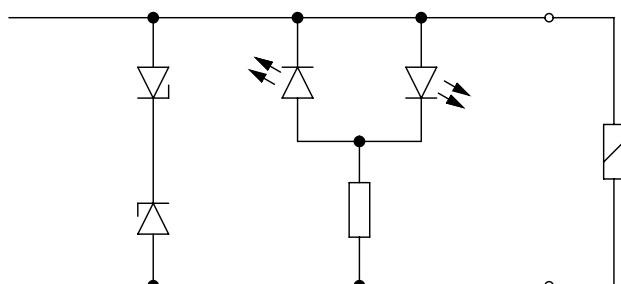

The solenoid coils have a protective circuit to arrest sparks and protect against polarity reversal.

Datasheet

Dimensions

Download CAD data → www.festo.com

2x 3/2-way, 5/2-way valve, double solenoid

5/2-way valve, single solenoid

 **Note**
More dimensions for
E-boxes
→ Page 113

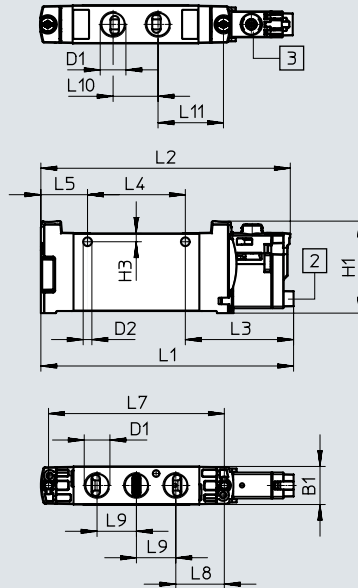
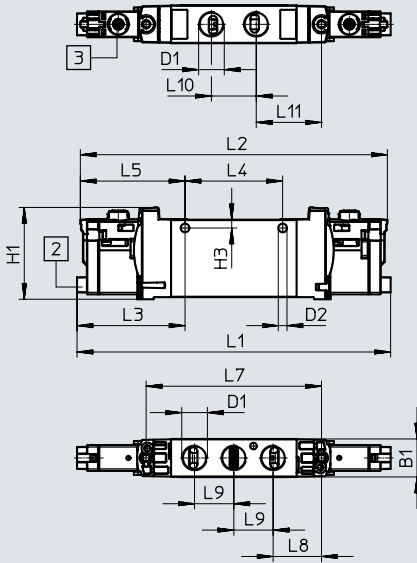

[2] Horizontal electrical connection

[3] Manual override

Type	B1	D1	D2	H1	H3	L1	L2	L3	L4	L5
VUVG-LK14-T32C...-G18...	14.4	G1/8	3.3	34.8	3.2	118.9	116.4	41	37	39.7
VUVG-LK14-B52...-G18...						95.6	94.4			17.7
VUVG-LK14-M52...-G18...										

Type	L7	L8	L9	L10	L11
VUVG-LK14-T32C...-G18...	66.5	18.4	14.9	17	24.8
VUVG-LK14-B52...-G18...					
VUVG-LK14-M52...-G18...					

Ordering data

★ Core Range

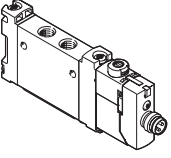
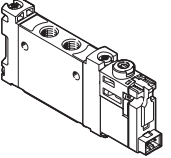
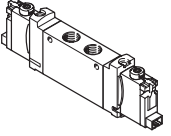



Ordering data			
	Description	Part no.	Type
In-line valve G1/8, with E-box R8			
	2x 3/2-way valve		
	Internal pilot air supply	Normally closed, pneumatic spring return	★ 8042566 VUVG-LK14-T32C-AT-G18-1R8L-S
	5/2-way valve, single solenoid		
	Internal pilot air supply	Pneumatic spring return	★ 8042567 VUVG-LK14-M52-AT-G18-1R8L-S
	5/2-way valve, double solenoid		
	Internal pilot air supply		★ 8042568 VUVG-LK14-B52-T-G18-1R8L-S
In-line valve G1/8, with E-box H2			
	2x 3/2-way valve		
	Internal pilot air supply	Normally closed, pneumatic spring return	★ 8042562 VUVG-LK14-T32C-AT-G18-1H2L-S
	5/2-way valve, single solenoid		
	Internal pilot air supply	Pneumatic spring return	★ 8042563 VUVG-LK14-M52-AT-G18-1H2L-S
	5/2-way valve, double solenoid		
	Internal pilot air supply		★ 8042564 VUVG-LK14-B52-T-G18-1H2L-S
Ordering data			
	Description	Part no.	Type
In-line valve G1/8, for battery manufacturing			
	2x 3/2-way valve		
	Internal pilot air supply	Normally closed, pneumatic spring return	8173205 VUVG-LK14-T32C-AT-G18-1H2L-F1A
	5/2-way valve, single solenoid		
	Internal pilot air supply	Pneumatic spring return	8173206 VUVG-LK14-M52-AT-G18-1H2L-F1A
	5/2-way valve, double solenoid		
	Internal pilot air supply		8173207 VUVG-LK14-B52-T-G18-1H2L-F1A

Datasheet

Function

2x 3/2C, 2x 3/2U, 2x 3/2H
 5/2-way, single solenoid
 5/2-way, double solenoid valve
 5/3C, 5/3U, 5/3E

Circuit diagrams → page 14

-  - Size 14 mm
-  - Flow rate
480 ... 780 l/min
-  - Voltage VUVG-...
5, 12 and 24 V DC
24, 110 and 230 V AC
-  - Voltage VUVG-...-P1
12 and 24 V DC
24, 110 and 230 V AC

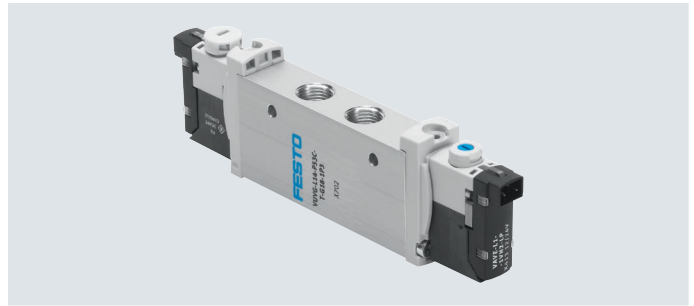

General technical data VUVG-L															
Valve function		T32-A			T32-M			M52-A	B52	M52-M	P53				
Normal position		C ¹⁾	U ²⁾	H ⁴⁾	C ¹⁾	U ²⁾	H ⁴⁾	–	–	–	C ¹⁾	U ²⁾	E ³⁾		
Stable position		Monostable							Bistable	Monostable					
Pneumatic spring return		Yes			No			Yes	–	No	–				
Mechanical spring return		No			Yes			No	–	Yes	Yes				
Vacuum operation at port 1		No			Only with external pilot air supply										
Size [mm]		14													
Design		Piston spool													
Sealing principle		Soft													
Actuation type		Electrical													
Type of control		Piloted													
Pilot air supply		Internal or external													
Exhaust air function		Can be throttled													
Manual override		VUVG-...		Choice of non-detenting, covered, non-detenting/detenting or detenting											
		VUVG-...-P1		Non-detenting, non-detenting/detenting											
Type of mounting		Optionally via through-holes ⁵⁾ or on manifold rail													
Mounting position		Any													
Nominal width [mm]		4.6			4.3			5.6	5.6	5.6	5.6				
Standard nominal flow rate [l/min]		560	600	590	550	500	500	780	780	780	650	560			
Flow rate on manifold rail [l/min]		560	580		520	480	480	680	700	700	620	560			
Switching time															
VUVG-...		On/off [ms]		9/25			12/18			14/22	–	13/37	12/40		
		Changeover [ms]		–								8	–	20	
VUVG-...-P1		On/off		11/18			14/13			16/16	–	12/26	14/24		
		Changeover		–								–	12	–	19
Pneumatic connection		1, 2, 3, 4, 5		G1/8											
		12/14		M5											
Certificate-issuing authority		VUVG-...-P1		UL MH19482											
Certification		VUVG-...		RCM											
		VUVG-...		c UL us - Recognized (OL)											
		VUVG-...-P1													

1) C=Normally closed/mid-position closed

2) U=Normally open/mid-position pressurised

3) E=Mid-position exhausted

4) H=2x 3/2-way valve in one housing with 1x normally closed and 1x normally open

5) If several valves are to be screwed together via the through-holes to form a block, a minimum distance of 0.3 mm must be ensured by inserting spacers.

Datasheet

General technical data VUVG-L							
Valve function		T32-A	T32-M	M52-A	B52	M52-M	P53
Product weight	VUVG-... [g]	89	80	78	89	70	89
	VUVG-...-P1 [g]	65	56	66	65	58	65
Certification for VUVG-...		c UL us - Recognized (OL) RCM					
CE marking (see declaration of conformity) ¹⁾							
VUVG-...		To EU EMC Directive					
VUVG-...-P1		To EU Low Voltage Directive					
Corrosion resistance class CRC ²⁾		2					
Certificate-issuing authority	VUVG-...-F1A	UL MH19482					

1) For information about the area of use, see the EC declaration of conformity at: www.festo.com/catalogue/... → Support/Downloads.

If the devices are subject to usage restrictions in residential, commercial or light-industrial environments, further measures for the reduction of the emitted interference may be necessary.

2) More information www.festo.com/x/topic/crc

Operating and environmental conditions								
Valve function		T32-A ¹⁾	T32-M ²⁾	M52-A ¹⁾	B52	M52-M ²⁾	P53	
Operating medium		Compressed air to ISO 8573-2010 [7:4:4]						
Operating pressure	Internal	[MPa]	0.15 ... 0.8	0.3 ... 0.8	0.25 ... 0.8	0.15 ... 0.8	0.3 ... 0.8	
		[bar]	1.5 ... 8	3 ... 8	2.5 ... 8	1.5 ... 8	3 ... 8	
	External VUVG-...	[MPa]	0.15 ... 1	-0.09 ... 1			-0.09 ... 0.8	-0.09 ... 1
		[bar]	1.5 ... 10	-0.9 ... 10			-0.9 ... 8	-0.9 ... 10
Pilot pressure ³⁾	Internal	[MPa]	0.15 ... 0.8	0.35 ... 0.8	0.25 ... 0.8	0.15 ... 0.8	0.3 ... 0.8	0.3 ... 0.8
		[bar]	1.5 ... 8	3.5 ... 8	2.5 ... 8	1.5 ... 8	3 ... 8	3 ... 8
	External VUVG-...	[MPa]	0.15 ... 0.8	0.3 ... 0.8	0.25 ... 0.8	0.15 ... 0.8	0.3 ... 0.8	0.3 ... 0.8
		[bar]	1.5 ... 8	3 ... 8	2.5 ... 8	1.5 ... 8	3 ... 8	3 ... 8
	VUVG-...-F1A	[MPa]	0.15 ... 0.8	0.2 ... 0.8	0.25 ... 0.8	0.15 ... 0.8	0.3 ... 0.8	0.3 ... 0.8
		[bar]	1.5 ... 8	2 ... 8	2.5 ... 8	1.5 ... 8	3 ... 8	3 ... 8
Ambient temperature	VUVG-...	[°C]	-5 ... +50, with holding current reduction -5 ... +60					
	VUVG-...-P1		-5 ... +50 for mounting on manifold rail, -5 ... +60					
Temperature of medium	VUVG-...	[°C]	-5 ... +50, with holding current reduction -5 ... +60					
	VUVG-...-P1		-5 ... +50, for mounting on manifold rail, -5 ... +60					

1) Pneumatic spring

2) Mechanical spring

3) Minimum pilot pressure 50% of operating pressure

Datasheet

Electrical data			
Electrical connection	VUVG-...		Via E-box → page 111
	VUVG-...-P1		Via electric pilot valve
Pilot interface	VUVG-...-P1		To ISO 15218
Operating voltage	VUVG-...	[V DC]	5, 12 and 24 ±10%
	VUVG-...-P1	[V DC]	12 and 24 ±10%
		[V AC]	24, 110 and 230 ±10%
Power	VUVG-...	[W]	1, reduced to 0.35 with holding current reduction
	VUVG-...-P1	[W]	1.3
Duty cycle		[%]	100
Protection rating to EN 60529	VUVG-...		IP40 (with plug socket), IP65 (with M8)
	VUVG-...-P1		IP65, with electric pilot valve and plug socket

Safety characteristics			
Max. positive test pulse with logic 0		[µs]	700
Max. negative test pulse with logic 1		[µs]	900
Shock resistance			Shock test with severity level 2 to FN 942017-5 and EN 60068-2-27
Vibration resistant			Transport application test with severity level 2 to FN 942017-4 and EN 60068-2-6

Information on materials			
Housing			Wrought aluminium alloy
Seals			HNBR, NBR
Note on materials			RoHS-compliant
LABS (PWIS) conformity			VDMA24364-B1/B2-L

Datasheet

Dimensions VUVG

Download CAD data → www.festo.com

2x 3/2-way, 5/2-way and 5/3-way valve

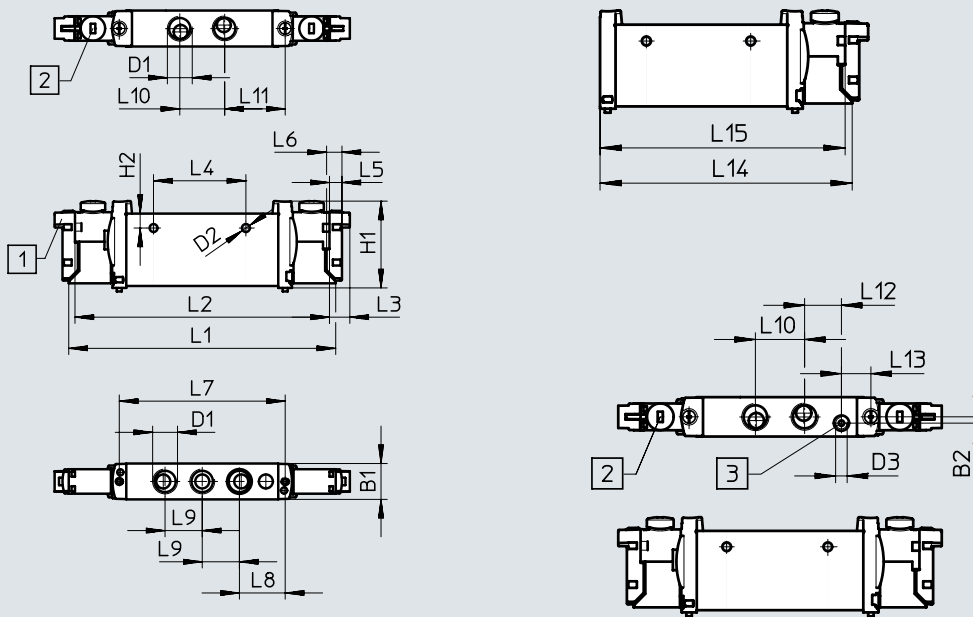

Note
 More dimensions for
 E-boxes
 → Page 113

[1] Horizontal electrical connection

[2] Manual override

[3] Port for external pilot air supply

Type	B1	B2	D1	D2 ∅	D3	H1	H2	L1	L2	L3	L4
VUVG-L14 ...-G18...	14.4	2.3	G1/8	3.2	M5	34.8	5.8	107	102	8	37
VUVG-S14 ...-G18...											

Type	L5	L6	L7	L8	L9	L10	L11	L12	L13	L14	L15
VUVG-L14 ...-G18...	4.85	6.2	66.5	18.35	14.9	18	24.3	13.5	10.8	89.4	87
VUVG-S14 ...-G18...											

Datasheet

Dimensions VUVG-...-P1

Download CAD data → www.festo.com

2x 3/2-way, 5/2-way and 5/3-way valve

5/2-way valve, single solenoid

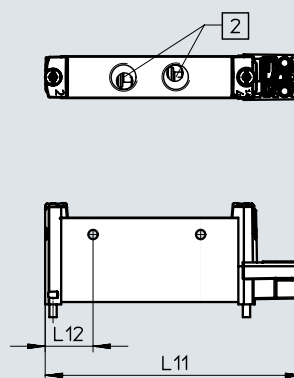
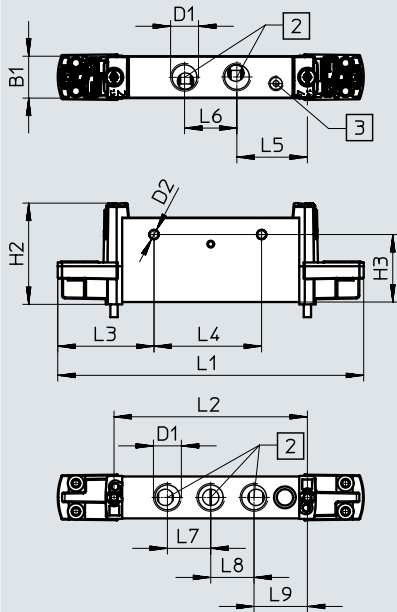

[2] Ports 1...5

[3] Port for external pilot air supply

Type	B1	D1	D2 ∅	H2	H3	L1	L2	L3	L4	L5	L6	L7	L8	L9	L11	L12
VUVG-L14 -...-P1	14.4	G1/8	3.2	34.8	23.2	105.2	66.5	33.1	37	24.3	18	14.9	14.9	18.4	88.6	16.5

Ordering data

★ Core Range

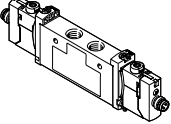
Ordering data		Description	Part no.	Type
In-line valve G1/8, with E-box R8				
	5/3-way valve			
	Internal pilot air supply	Mid-position closed, mechanical spring return	★ 574231	VUVG-L14-P53C-T-G18-1R8L

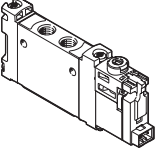
Ordering data		Description	Part no.	Type
In-line valve G1/8, without E-box				
	2x 3/2-way valve			
	Internal pilot air supply	Normally closed, pneumatic spring return	566496	VUVG-L14-T32-AT-G18-1P3
		Normally open, pneumatic spring return	566497	VUVG-L14-32U-AT-G18-1P3
		1x normally open, 1x normally closed, pneumatic spring return	566498	VUVG-L14-T32H-AT-G18-1P3
		Normally closed, mechanical spring return	574368	VUVG-L14-T32C-MT-G18-1P3
		Normally open, mechanical spring return	574369	VUVG-L14-T32U-MT-G18-1P3
		1x normally open, 1x normally closed, mechanical spring return	574370	VUVG-L14-T32H-MT-G18-1P3
	External pilot air supply	Normally closed, pneumatic spring return	566505	VUVG-L14-T32C-AZT-G18-1P3
		Normally open, pneumatic spring return	566506	VUVG-L14-T32U-AZT-G18-1P3
		1x normally open, 1x normally closed, pneumatic spring return	566507	VUVG-L14-T32H-AZTG18-1P3
		Normally closed, mechanical spring return	574372	VUVG-L14-T32C-MZT-G18-1P3
		Normally open, mechanical spring return	574373	VUVG-L14-T32U-MZT-G18-1P3
		Normally closed, mechanical spring return	574374	VUVG-L14-T32H-MZT-G18-1P3
	5/2-way valve, single solenoid			
	Internal pilot air supply	Pneumatic spring return	566499	VUVG-L14-M52-AT-G18-1P3
		Mechanical spring return	574371	VUVG-L14-M52-MT-G18-1P3
	External pilot air supply	Pneumatic spring return	566508	VUVG-L14-M52-AZT-G18-1P3
Mechanical spring return		574375	VUVG-L14-M52-MZT-G18-1P3	
5/2-way valve, double solenoid				
Internal pilot air supply		566500	VUVG-L14-B52-T-G18-1P3	
External pilot air supply		566509	VUVG-L14-B52-ZT-G18-1P3	

Ordering data

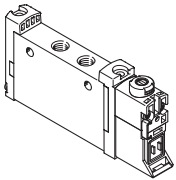
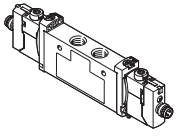
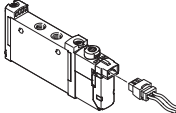
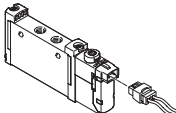
Ordering data		Description	Part no.	Type	
In-line valve G1/8, without E-box					
	5/3-way valve				
	Internal pilot air supply	Mid-position closed, mechanical spring return	566501	VUVG-L14-P53C-T-G18-1P3	
		Mid-position exhausted, mechanical spring return	566502	VUVG-L14-P53E-T-G18-1P3	
		Mid-position pressurised, mechanical spring return	566503	VUVG-L14-P53U-T-G18-1P3	
	External pilot air supply	Mid-position closed, mechanical spring return	566510	VUVG-L14-P53C-ZT-G18-1P3	
		Mid-position exhausted, mechanical spring return	566511	VUVG-L14-P53E-ZT-G18-1P3	
Mid-position pressurised, mechanical spring return		566512	VUVG-L14-P53U-ZT-G18-1P3		
In-line valve G1/8, with E-box R8					
	2x 3/2-way valve				
	Internal pilot air supply	Normally closed, pneumatic spring return	574226	VUVG-L14-T32C-AT-G18-1R8L	
		Normally open, pneumatic spring return	574227	VUVG-L14-T32U-AT-G18-1R8L	
		1x normally open, 1x normally closed, pneumatic spring return	574228	VUVG-L14-T32H-AT-G18-1R8L	
		Normally closed, mechanical spring return	8031504	VUVG-L14-T32C-MT-G18-1R8L	
		Normally open, mechanical spring return	8031505	VUVG-L14-T32U-MT-G18-1R8L	
		1x normally open, 1x normally closed, mechanical spring return	8031506	VUVG-L14-T32H-MT-G18-1R8L	
	5/2-way valve, single solenoid				
	Internal pilot air supply	Pneumatic spring return	574229	VUVG-L14-M52-AT-G18-1R8L	
		Mechanical spring return	8031508	VUVG-L14-M52-MT-G18-1R8L	
	5/2-way valve, double solenoid				
	Internal pilot air supply		574230	VUVG-L14-B52-T-G18-1R8L	
5/3-way valve					
Internal pilot air supply	Mid-position exhausted, mechanical spring return	574233	VUVG-L14-P53E-T-G18-1R8L		
	Mid-position pressurised, mechanical spring return	574232	VUVG-L14-P53U-T-G18-1R8L		
In-line valve G1/8, with E-box H2					
	2x 3/2-way valve				
	Internal pilot air supply	Normally closed, pneumatic spring return	577321	VUVG-L14-T32C-AT-G18-1H2L-W1	
	5/2-way valve, single solenoid				
	Internal pilot air supply	Pneumatic spring return	576256	VUVG-L14-M52-AT-G18-1H2L-W1	
		Mechanical spring return	578164	VUVG-L14-M52-MT-G18-1H2L-W1	
5/2-way valve, double solenoid					
Internal pilot air supply		577319	VUVG-L14-B52-T-G18-1H2L-W1		
Semi in-line valve G1/8, with E-box H2					
5/2-way valve, single solenoid					
	Internal pilot air supply	Pneumatic spring return	577325	VUVG-S14-M52-AT-G18-1H2L-W1	

Ordering data

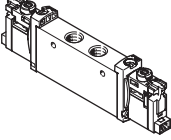
Ordering data	Description	Part no.	Type	
In-line valve G1/8, for battery manufacturing				
	2x 3/2-way valve			
	Internal pilot air supply	Normally closed, mechanical spring return	8164552	VUVG-L14-T32C-MT-G18-1H2L-F1A
		Normally open, pneumatic spring return	8164553	VUVG-L14-T32U-AT-G18-1H2L-F1A
		Normally open, mechanical spring return	8164554	VUVG-L14-T32U-MT-G18-1H2L-F1A
		1x normally open, 1x normally closed, pneumatic spring return	8164555	VUVG-L14-T32H-AT-G18-1H2L-F1A
		1x normally open, 1x normally closed, mechanical spring return	8164556	VUVG-L14-T32H-MT-G18-1H2L-F1A
	External pilot air supply	Normally closed, pneumatic spring return	8164561	VUVG-L14-T32C-AZT-G18-1H2L-F1A
		Normally closed, mechanical spring return	8164562	VUVG-L14-T32C-MZT-G18-1H2L-F1A
		Normally open, pneumatic spring return	8164563	VUVG-L14-T32U-AZT-G18-1H2L-F1A
		Normally open, mechanical spring return	8164564	VUVG-L14-T32U-MZT-G18-1H2L-F1A
		1x normally open, 1x normally closed, pneumatic spring return	8164565	VUVG-L14-T32H-AZT-G18-1H2L-F1A
		1x normally open, 1x normally closed, mechanical spring return	8164566	VUVG-L14-T32H-MZT-G18-1H2L-F1A
	5/2-way valve, single solenoid			
	Internal pilot air supply	Mechanical spring return	8164557	VUVG-L14-M52-MT-G18-1H2L-F1A
	External pilot air supply	Pneumatic spring return	8164567	VUVG-L14-M52-AZT-G18-1H2L-F1A
		Mechanical spring return	8164568	VUVG-L14-M52-MZT-G18-1H2L-F1A
	5/2-way valve, double solenoid			
	External pilot air supply		8164569	VUVG-L14-B52-ZT-G18-1H2L-F1A
	5/3-way valve			
	Internal pilot air supply	Mid-position closed	8164558	VUVG-L14-P53C-T-G18-1H2L-F1A
Mid-position exhausted		8164559	VUVG-L14-P53E-T-G18-1H2L-F1A	
Mid-position pressurised		8164560	VUVG-L14-P53U-T-G18-1H2L-F1A	
External pilot air supply	Mid-position closed	8164570	VUVG-L14-P53C-ZT-G18-1H2L-F1A	
	Mid-position exhausted	8164571	VUVG-L14-P53E-ZT-G18-1H2L-F1A	
	Mid-position pressurised	8164572	VUVG-L14-P53U-ZT-G18-1H2L-F1A	

Ordering data

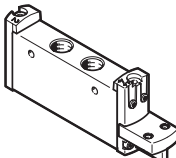
Ordering data	Description	Part no.	Type	
In-line valve G1/8, to ISO 15218				
	2x 3/2-way valve			
	Internal pilot air supply	Normally closed, pneumatic spring return	8033523	VUVG-L14-T32C-A-G18-P1
		Normally open, pneumatic spring return	8033524	VUVG-L14-T32U-A-G18-P1
		1x normally open, 1x normally closed, pneumatic spring return	8033525	VUVG-L14-T32H-A-G18-P1
		Normally closed, mechanical spring return	8033526	VUVG-L14-T32C-M-G18-P1
		Normally open, mechanical spring return	8033527	VUVG-L14-T32U-M-G18-P1
		1x normally open, 1x normally closed, mechanical spring return	8033528	VUVG-L14-T32H-M-G18-P1
	5/2-way valve, single solenoid			
	Internal pilot air supply	Pneumatic spring return	8033529	VUVG-L14-M52-A-G18-P1
		Mechanical spring return	8033530	VUVG-L14-M52-M-G18-P1
	5/2-way valve, double solenoid			
	Internal pilot air supply	–	8033531	VUVG-L14-B52-G18-P1
	5/3-way valve			
	Internal pilot air supply	Mid-position closed, mechanical spring return	8033532	VUVG-L14-P53C-G18-P1
Mid-position exhausted, mechanical spring return		8033533	VUVG-L14-P53E-G18-P1	
Mid-position pressurised, mechanical spring return		8033534	VUVG-L14-P53U-G18-P1	

Manifold assembly

In-line valves for manifold assembly

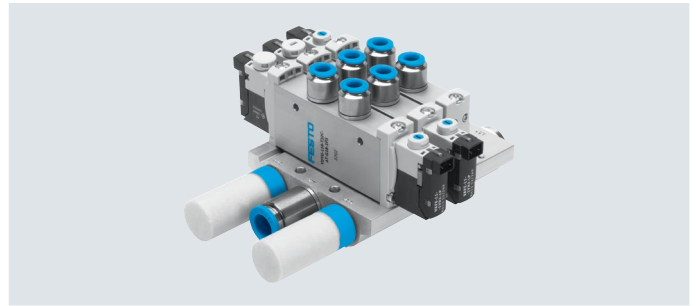

Dimensions

Download CAD data → www.festo.com

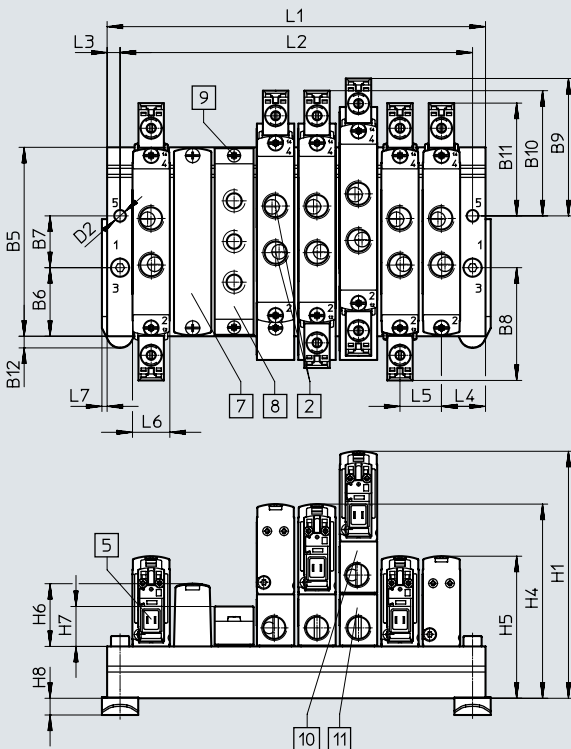

Note
More dimensions for
E-boxes
→ Page 113

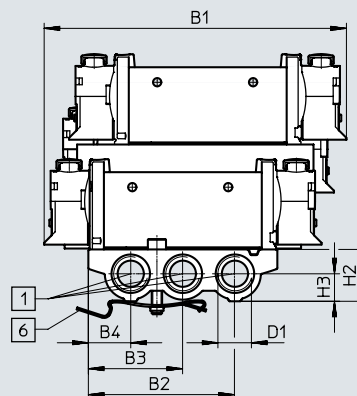

- | | | | |
|-------------------------------------------------------|------------------------------------------------------------------|---------------------------------------------------------------|--------------------------------------|
| [1] Ports 1, 3 and 5: G1/4 (at both ends) | [6] H-rail mounting (two M4x25 screws are required for mounting) | [8] Supply plate, ports 1, 3 and 5: G1/8 | [10] Vertical pressure supply plate |
| [2] Ports 1, 2, 3, 4 and 5 on the valve: G1/8 | [7] Cover plate | [9] Valves/cover plate mounting on manifold rail: M2.5 thread | [11] Vertical pressure exhaust plate |
| [5] Electrical connection for E-boxes and accessories | | | |

Type	B1	B2	B3	B4	B5	B6	B7	B8	B9	B10	B11	B12	D1	D2
VABM-L1-14S-G14	116.6	56.6	36.5	16.4	72.9	26.5	20	43.5	53.1	48.3	43.5	4.5	G1/4	4.5

Type	H1	H2	H3	H4	H5	H6	H7	H8	L3	L4	L5	L6	L7
VABM-L1-14S-G14	95.3	20	10.6	74.9	54.8	23.9	15.4	6.5	5	17	16	14.5	2

Valve positions	2	3	4	5	6	7	8	9	10	12	14	16	22
L1	50	66	82	98	114	130	146	162	178	210	242	274	306
L2	40	56	72	88	104	120	136	152	168	200	232	264	296
VABM weight [g]	118	159	200	241	282	323	364	405	446	528	610	692	938

Ordering data

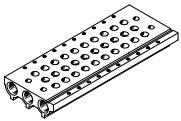

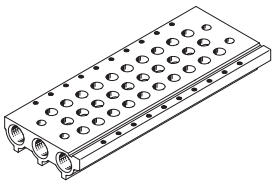

Technical data – Manifold rails								
	Port 1, 3, 5	CRC	Material ²⁾	Operating pressure		Max. tightening torque for assembly [Nm]		
				[MPa]	[bar]	Valve	H-rail	Wall
	G1/4	2 ¹⁾	Wrought aluminium alloy	0.15 ... 0.8	1.5 ... 8	0.65	1.5	3

1) More information www.festo.com/x/topic/crc

2) Information on materials: RoHS-compliant.

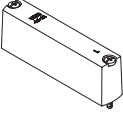
Ordering data – Manifold rail			
	Description	Part no.	Type
Manifold rail for in-line valves (manifold assembly)			
	For size G1/8	2 valve positions	★ 566618 VABM-L1-14S-G14-2
		3 valve positions	★ 566619 VABM-L1-14S-G14-3
		4 valve positions	★ 566620 VABM-L1-14S-G14-4
		5 valve positions	566621 VABM-L1-14S-G14-5
		6 valve positions	★ 566622 VABM-L1-14S-G14-6
		7 valve positions	566623 VABM-L1-14S-G14-7
		8 valve positions	★ 566624 VABM-L1-14S-G14-8
		9 valve positions	566625 VABM-L1-14S-G14-9
		10 valve positions	★ 566626 VABM-L1-14S-G14-10
		12 valve positions	566627 VABM-L1-14S-G14-12
		14 valve positions	566628 VABM-L1-14S-G14-14
		16 valve positions	566629 VABM-L1-14S-G14-16

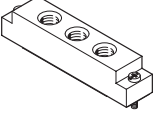
Ordering data

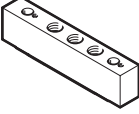
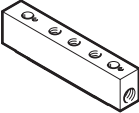



Ordering data – Accessories				
Description		Part no.	Type	
Cover plate Datasheets → Internet: vabb				
	For valve position on manifold rail, including screws and seal	★ 569989	VABB-L1-14	
Separator Datasheets → Internet: vabd				
	For creating pressure zones	569996	VABD-10-B	
Supply plate Datasheets → Internet: vabf				
	For valve position on manifold rail, including screws and seal	569993	VABF-L1-14-P3A4-G18	
Seats for in-line valves Datasheets → Internet: vabd				
	In-line valves VUVG-LK			
	For G1/8 in-line valves	Delivery quantity: 10 sets (each with 2 screws and 1 seal)	–	★ 8043720 VABD-L1-14XK-S-G18-S
			Suitable for battery manufacturing	8168886 VABD-L1-14XK-S-G18-F1A
	In-line valves VUVG-L			
For G1/8 in-line valves	Delivery quantity: 10 sets (each with 2 screws and 1 seal)	–	★ 566675 VABD-L1-14X-S-G18	
		Suitable for battery manufacturing	8168589 VABD-L1-14X-S-G18-F1A	
Vertical pressure supply plate				
	Pneumatic connection 1: G1/8	Terminal code CP	574593	VABF-L1-P3A3-G18
Vertical pressure exhaust plate				
	Pneumatic connection 3, 5: G1/8	Terminal code CR	574595	VABF-L1-P7A13-G18

Datasheet

Function

2x 3/2C, 2x 3/2U, 2x 3/2H
5/2-way, single solenoid
5/2-way, double solenoid valve
5/3C, 5/3U, 5/3E

Circuit diagrams → page 14

-  Size 18 mm
-  Flow rate
780 ... 1380 l/min
-  Voltage
5, 12 and 24 V DC
24, 110 and 230 V AC
-  Voltage VUVG-...-P1
12 and 24 V DC
24, 110 and 230 V AC

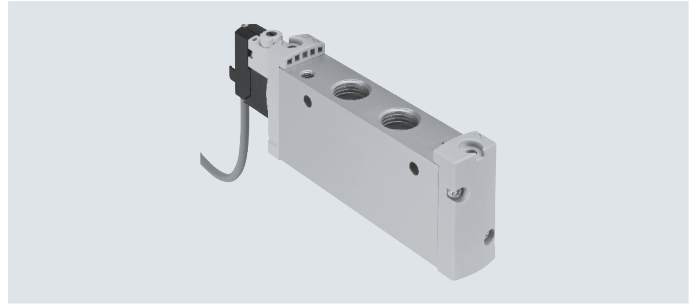

General technical data VUVG-L												
Valve function	T32-A			T32-M			M52-R	B52	M52-M	P53		
Normal position	C ¹⁾	U ²⁾	H ⁴⁾	C ¹⁾	U ²⁾	H ⁴⁾	–	–	–	C ¹⁾	U ²⁾	E ³⁾
Stable position	Monostable							Bista- ble	Monostable			
Pneumatic spring return	Yes			No			Yes ⁵⁾	–	No	–		
Mechanical spring return	No			Yes			Yes ⁵⁾	–	Yes	Yes		
Vacuum operation at port 1	No			Only with external pilot air supply								
Size [mm]	18											
Design	Piston spool											
Sealing principle	Soft											
Actuation type	Electrical											
Type of control	Piloted											
Pilot air supply	Internal/external											
Exhaust air function	Can be throttled											
Manual override	VUVG-...		Choice of non-detenting, covered, non-detenting/detenting or detenting									
	VUVG-...-P1		Non-detenting, non-detenting/detenting									
Type of mounting	Optionally via through-holes ⁶⁾ or on manifold rail											
Mounting position	Any											
Nominal width [mm]	5.7						6.9	7.3	6.9	6.5	6.3	
Standard nominal flow rate [l/min]	880	970	950	870	990	920	1300	1380	1300	1200	1000	910
Flow rate on manifold rail	780	980	820	780	960	820	1300	1370	1300	1180	1220	1050
Switching time												
VUVG-...	On/off [ms]	13/27			15/22			8/31	–	10/45	15/48	
	Changeover [ms]	–			–			–	11	–	29	
VUVG-...-P1	On/off [ms]	13/18			16/15			16/22	–	14/26	15/32	
	Changeover [ms]	–			–			–	12	–	21	
Pneumatic connection	1, 2, 3, 4, 5	G1/4										
	12/14	M5										
Product weight [g]	VUVG-...	164			164			154	164	154	160	
	VUVG-...-P1	140			140			142	140	142	136	
Certificate-issuing authority	VUVG-...-P1		UL MH19482									
Certification	VUVG-...		RCM									
	VUVG-...		c UL us - Recognized (OL)									
	VUVG-...-P1											
CE marking (see declaration of conformity)⁷⁾												
	VUVG-...		To EU EMC Directive									
	VUVG-...-P1		To EU Low Voltage Directive									
Corrosion resistance class CRC ⁸⁾	2											

1) C=Normally closed/mid-position closed

2) U=Normally open/mid-position pressurised

3) E=Mid-position exhausted

4) H=2x 3/2-way valve in one housing with 1x normally closed and 1x normally open

5) Combined reset method

6) If several valves are to be screwed together via the through-holes to form a block, a minimum distance of 0.3 mm must be ensured by inserting spacers.

7) For information about the area of use, see the EC declaration of conformity at: www.festo.com/catalogue/... → Support/Downloads.

If the devices are subject to usage restrictions in residential, commercial or light-industrial environments, further measures for the reduction of the emitted interference may be necessary.

8) More information www.festo.com/x/topic/crc

Datasheet

Operating and environmental conditions			T32-A ¹⁾	T32-M ³⁾	M52-R ²⁾	B52	M52-M ³⁾	P53
Valve function								
Operating medium			Compressed air to ISO 8573-2010 [7:4:4]					
Note on the operating/pilot medium			Lubricated operation possible (in which case lubricated operation will always be required)					
Operating pressure	Internal	[MPa]	0.15 ... 0.8	0.3 ... 0.8	0.25 ... 0.8	0.15 ... 0.8	0.3 ... 0.8	
		[bar]	1.5 ... 8	3 ... 8	2.5 ... 8	1.5 ... 8	3 ... 8	
	External VUVG-...	[MPa]	0.15 ... 1	-0.09 ... 1				
		[bar]	1.5 ... 10	-0.9 ... 10				
Pilot pressure ⁴⁾		[MPa]	0.15 ... 0.8	0.2 ... 0.8	0.25 ... 0.8	0.15 ... 0.8	0.3 ... 0.8	
		[bar]	1.5 ... 8	2 ... 8	2.5 ... 8	1.5 ... 8	3 ... 8	
Ambient temperature	VUVG-...	[°C]	-5 ... +50, with holding current reduction -5 ... +60					
	VUVG-...-P1	[°C]	-5 ... +50 for mounting on manifold rail, -5 ... +60					
Temperature of medium	VUVG-...	[°C]	-5 ... +50, with holding current reduction -5 ... +60					
	VUVG-...-P1	[°C]	-5 ... +50 for mounting on manifold rail, -5 ... +60					

- 1) Pneumatic spring
2) Combined pneumatic/mechanical spring
3) Mechanical spring
4) Minimum pilot pressure 50% of operating pressure

Electrical data			
Electrical connection	VUVG-...		Via E-box → page 111
	VUVG-...-P1		Via electric pilot valve
Pilot interface	VUVG-...-P1		To ISO 15218
Operating voltage	VUVG-...	[V DC]	5, 12 and 24 ±10%
	VUVG-...-P1	[V DC]	12 and 24 ±10%
		[V AC]	24, 110 and 230 ±10%
Power	VUVG-...	[W]	1, reduced to 0.35 with holding current reduction
	VUVG-...-P1	[W]	1.3
Duty cycle		[%]	100
Protection rating to EN 60529			
	VUVG-...		IP40 (with plug socket), IP65 (with M8)
	VUVG-...-P1		IP65, with electric pilot valve and plug socket

Safety characteristics		
Max. positive test pulse with logic 0	[µs]	700
Max. negative test pulse with logic 1	[µs]	900
Shock resistance		Shock test with severity level 2 to FN 942017-5 and EN 60068-2-27
Vibration resistant		Transport application test with severity level 2 to FN 942017-4 and EN 60068-2-6

Information on materials	
Housing	Wrought aluminium alloy
Seals	HNBR, NBR
Note on materials	RoHS-compliant
LABS (PWIS) conformity	VDMA24364-B1/B2-L

Datasheet

Dimensions VUVG-...

Download CAD data → www.festo.com

2x 3/2-way, 5/2-way and 5/3-way valve

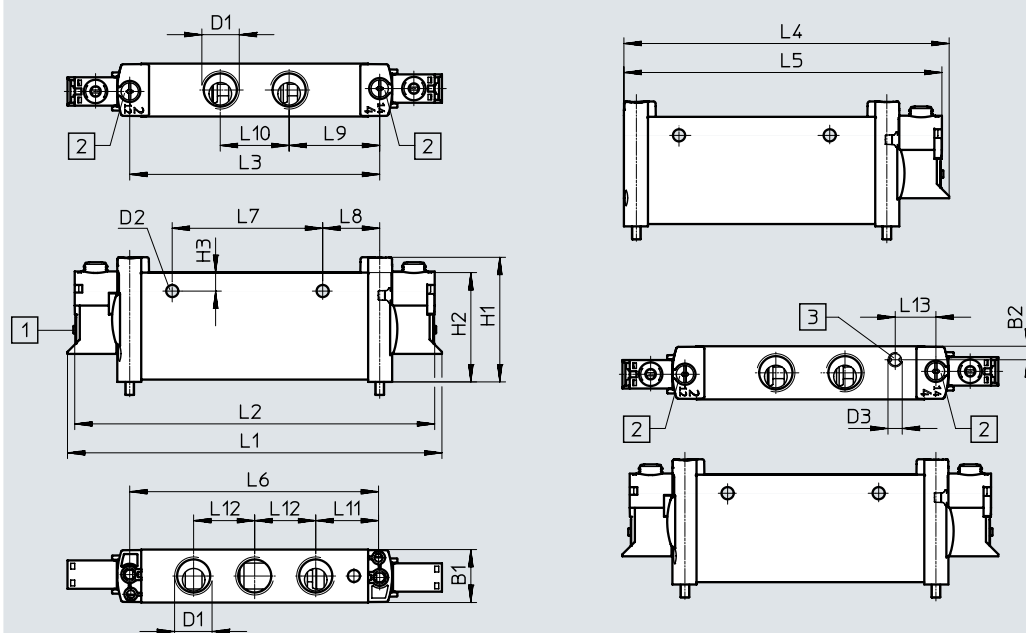

Note
More dimensions for
E-boxes
→ Page 113

[1] Electrical connection
without E-box

[2] Retaining screw

[3] Port for external pilot air
supply

Type	B1	B2	D1	D2 ∅	D3	H1	H2	H3	L1	L2	L3
VUVG-L18-...	18.3	4.5	G1/4	4.2	M5	43.1	37.8	6.4	129.4	124.4	86.4
VUVG-S18-...											

Type	L4	L5	L6	L7	L8	L9	L10	L11	L12	L13
VUVG-L18-...	112.2	109.7	86	52	19.7	31.3	23.8	21.7	21.1	14
VUVG-S18-...										

Datasheet

Dimensions VUVG-...-P1

Download CAD data → www.festo.com

2x 3/2-way, 5/2-way and 5/3-way valve

5/2-way valve, single solenoid

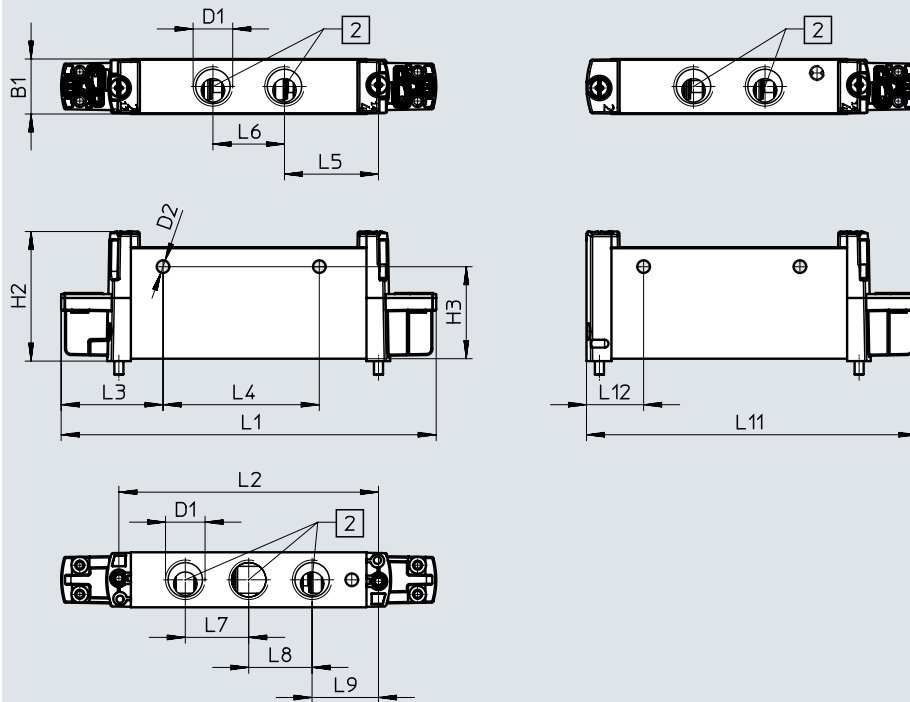

[2] Ports 1... 5

Type	B1	D1	D2	H2	H3	L1	L2	L3
VUVG-L18-...-P1	18.3	G1/4	∅ 4.2	43.1	30.6	124.8	86.4	33.9

Type	L4	L5	L6	L7	L8	L9	L11	L12
VUVG-L18-...-P1	52	31.3	23.8	21.1	21.1	22.1	109.9	19

Ordering data

★ Core Range

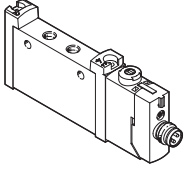
Ordering data		Description	Part no.	Type
In-line valve G1/4, with E-box R8				
	2x 3/2-way valve			
	Internal pilot air supply	Normally closed, pneumatic spring return	★ 8031525	VUVG-L18-T32C-AT-G14-1R8L
	5/2-way valve, single solenoid			
	Internal pilot air supply	Pneumatic/mechanical spring return	★ 8031531	VUVG-L18-M52-RT-G14-1R8L
		Mechanical spring return	★ 8031532	VUVG-L18-M52-MT-G14-1R8L
	5/3-way valve			
Internal pilot air supply	Mid-position closed, mechanical spring return	★ 8031534	VUVG-L18-P53C-T-G14-1R8L	

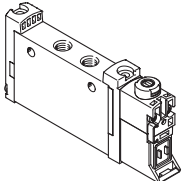
Ordering data		Description	Part no.	Type
In-line valve G1/4, without E-box				
	2x 3/2-way valve			
	Internal pilot air supply	Normally closed, pneumatic spring return	574422	VUVG-L18-T32C-AT-G14-1P3
		Normally open, pneumatic spring return	574423	VUVG-L18-T32U-AT-G14-1P3
		1x normally open, 1x normally closed, pneumatic spring return	574424	VUVG-L18-T32H-AT-G14-1P3
		Normally closed, mechanical spring return	574425	VUVG-L18-T32C-MT-G14-1P3
		Normally open, mechanical spring return	574426	VUVG-L18-T32U-MT-G14-1P3
		1x normally open, 1x normally closed, mechanical spring return	574427	VUVG-L18-T32H-MT-G14-1P3
	External pilot air supply	Normally closed, mechanical spring return	574434	VUVG-L18-T32C-MZT-G14-1P3
		Normally open, mechanical spring return	574435	VUVG-L18-T32U-MZT-G14-1P3
		1x normally open, 1x normally closed, mechanical spring return	574436	VUVG-L18-T32H-MZT-G14-1P3
	5/2-way valve, single solenoid			
	Internal pilot air supply	Pneumatic/mechanical spring return	574428	VUVG-L18-M52-RT-G14-1P3
		Mechanical spring return	574429	VUVG-L18-M52-MT-G14-1P3
	External pilot air supply	Mechanical spring return	574438	VUVG-L18-M52-MZT-G14-1P3
		Pneumatic/mechanical spring return	574437	VUVG-L18-M52-RZT-G14-1P3
5/2-way valve, double solenoid				
Internal pilot air supply		574430	VUVG-L18-B52-T-G14-1P3	
External pilot air supply		574439	VUVG-L18-B52-ZT-G14-1P3	

Ordering data

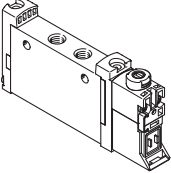
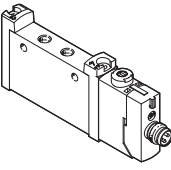
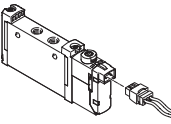
Ordering data		Description	Part no.	Type	
In-line valve G1/4, without E-box					
	5/3-way valve				
	Internal pilot air supply	Mid-position closed, mechanical spring return	574431	VUVG-L18-P53C-T-G14-1P3	
		Mid-position exhausted, mechanical spring return	574432	VUVG-L18-P53E-T-G14-1P3	
		Mid-position pressurised, mechanical spring return	574433	VUVG-L18-P53U-T-G14-1P3	
	External pilot air supply	Mid-position closed, mechanical spring return	574440	VUVG-L18-P53C-ZT-G14-1P3	
		Mid-position exhausted, mechanical spring return	574441	VUVG-L18-P53E-ZT-G14-1P3	
Mid-position pressurised, mechanical spring return		574442	VUVG-L18-P53U-ZT-G14-1P3		
In-line valve G1/4, with E-box R8					
	2x 3/2-way valve				
	Internal pilot air supply	Normally open, pneumatic spring return	8031526	VUVG-L18-T32U-AT-G14-1R8L	
		1x normally open, 1x normally closed, pneumatic spring return	8031527	VUVG-L18-T32H-AT-G14-1R8L	
		Normally closed, mechanical spring return	8031528	VUVG-L18-T32C-MT-G14-1R8L	
		Normally open, mechanical spring return	8031529	VUVG-L18-T32U-MT-G14-1R8L	
		1x normally open, 1x normally closed, mechanical spring return	8031530	VUVG-L18-T32H-MT-G14-1R8L	
	5/2-way valve, double solenoid				
	Internal pilot air supply		8031533	VUVG-L18-B52-T-G14-1R8L	
	5/3-way valve				
	Internal pilot air supply	Mid-position exhausted, mechanical spring return	8031535	VUVG-L18-P53E-T-G14-1R8L	
Mid-position pressurised, mechanical spring return		8031536	VUVG-L18-P53U-T-G14-1R8L		
In-line valve G1/4, with E-box H2					
	5/2-way valve, single solenoid				
	Internal pilot air supply	Pneumatic/mechanical spring return	578823	VUVG-L18-M52-RT-G14-1H2L-W1	

Ordering data

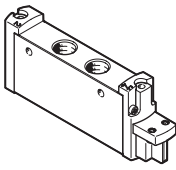
Ordering data		Description	Part no.	Type
In-line valve G1/4, to ISO 15218				
	2x 3/2-way valve			
	Internal pilot air supply	Normally closed, pneumatic spring return	8033547	VUVG-L18-T32C-A-G14-P1
		Normally open, pneumatic spring return	8033548	VUVG-L18-T32U-A-G14-P1
		1x normally open, 1x normally closed, pneumatic spring return	8033549	VUVG-L18-T32H-A-G14-P1
		Normally closed, mechanical spring return	8033550	VUVG-L18-T32C-M-G14-P1
		Normally open, mechanical spring return	8033551	VUVG-L18-T32U-M-G14-P1
		1x normally open, 1x normally closed, mechanical spring return	8033552	VUVG-L18-T32H-M-G14-P1
	5/2-way valve, single solenoid			
	Internal pilot air supply	Pneumatic/mechanical spring return	8033553	VUVG-L18-M52-R-G14-P1
		Mechanical spring return	8033554	VUVG-L18-M52-M-G14-P1
5/2-way valve, double solenoid				
Internal pilot air supply		8033555	VUVG-L18-B52-G14-P1	
5/3-way valve				
Internal pilot air supply	Mid-position closed, mechanical spring return	8033556	VUVG-L18-P53C-G14-P1	
	Mid-position exhausted, mechanical spring return	8033557	VUVG-L18-P53E-G14-P1	
	Mid-position pressurised, mechanical spring return	8033558	VUVG-L18-P53U-G14-P1	

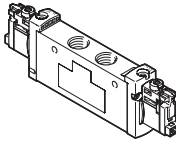
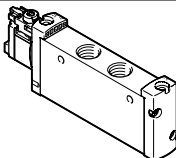
Ordering data		Description	Part no.	Type
In-line valve G1/4, for battery manufacturing				
	2x 3/2-way valve			
	Internal pilot air supply	Normally closed, pneumatic spring return	8172829	VUVG-L18-T32C-AT-G14-1H2L-F1A
		Normally closed, mechanical spring return	8172830	VUVG-L18-T32C-MT-G14-1H2L-F1A
		Normally open, pneumatic spring return	8172831	VUVG-L18-T32U-AT-G14-1H2L-F1A
		Normally closed, mechanical spring return	8172832	VUVG-L18-T32U-MT-G14-1H2L-F1A
		1x normally open, 1x normally closed, pneumatic spring return	8172833	VUVG-L18-T32H-AT-G14-1H2L-F1A
		1x normally open, 1x normally closed, mechanical spring return	8172834	VUVG-L18-T32H-MT-G14-1H2L-F1A
	External pilot air supply	Normally closed, mechanical spring return	8172841	VUVG-L18-T32C-MZT-G14-1H2L-F1A
		Normally open, pneumatic spring return	8172842	VUVG-L18-T32U-MZT-G14-1H2L-F1A
		1x normally open, 1x normally closed, mechanical spring return	8172843	VUVG-L18-T32H-MZT-G14-1H2L-F1A
	5/2-way valve, single solenoid			
	Internal pilot air supply	Pneumatic/mechanical spring return	8172835	VUVG-L18-M52-RT-G14-1H2L-F1A
		Mechanical spring return	8172836	VUVG-L18-M52-MT-G14-1H2L-F1A
	External pilot air supply	Pneumatic/mechanical spring return	8172844	VUVG-L18-M52-RZT-G14-1H2L-F1A
		Mechanical spring return	8172845	VUVG-L18-M52-MZT-G14-1H2L-F1A
	5/2-way valve, double solenoid			
Internal pilot air supply		8172837	VUVG-L18-B52-T-G14-1H2L-F1A	
External pilot air supply		8172846	VUVG-L18-B52-ZT-G14-1H2L-F1A	
5/3-way valve				
Internal pilot air supply	Mid-position closed	8172838	VUVG-L18-P53C-T-G14-1H2L-F1A	
	Mid-position exhausted	8172839	VUVG-L18-P53E-T-G14-1H2L-F1A	
	Mid-position pressurised	8172840	VUVG-L18-P53U-T-G14-1H2L-F1A	
External pilot air supply	Mid-position closed	8172847	VUVG-L18-P53C-ZT-G14-1H2L-F1A	
	Mid-position exhausted	8172848	VUVG-L18-P53E-ZT-G14-1H2L-F1A	
	Mid-position pressurised	8172849	VUVG-L18-P53U-ZT-G14-1H2L-F1A	

Manifold assembly

In-line valves for manifold assembly

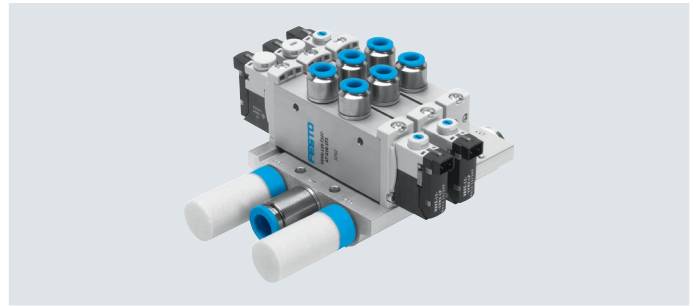

Dimensions

Download CAD data → www.festo.com

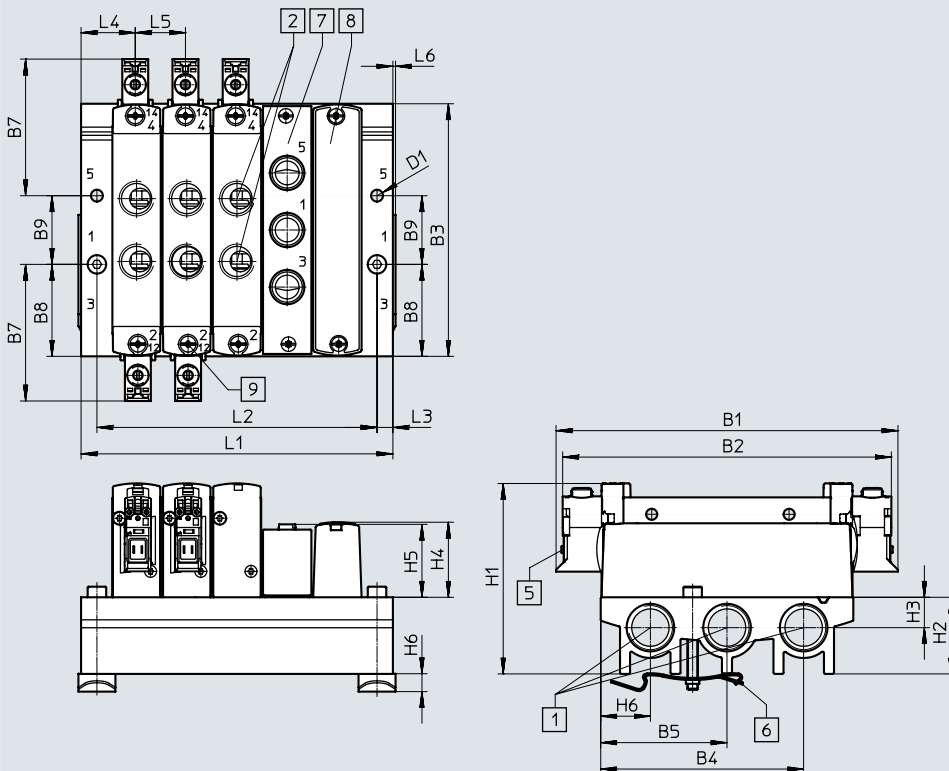

Note
More dimensions for
E-boxes
→ Page 113

- [1] Ports 1, 3 and 5: G3/8 (at both ends)
- [2] Ports 2 and 4: G1/4
- [5] Electrical connection for E-boxes and accessories
- [6] H-rail mounting (two M4x35 screws are required for mounting)
- [7] Cover plate
- [8] Supply plate, ports 1, 3 and 5: G1/4
- [9] Valves/cover plate mounting on manifold rail: M3 thread

Type	B1	B2	B3	B4	B5	B6	B7	B8	B9	D1
VABM-L1-18S-G38	129.4	124.4	95.6	76.8	47.8	18.8	51.7	34.8	26	4.5

Type	H1	H2	H3	H4	H5	H6	L3	L4	L5	L6
VABM-L1-18S-G38	72.1	29	11.5	28.4	27.6	6.5	6	20.5	19	1

Valve positions	2	3	4	5	6	7	8	9	10	12	14	16
L1	61	80	99	118	137	156	175	194	213	251	289	327
L2	49	68	87	106	125	144	163	182	201	239	277	315
VABM weight [g]	118	159	200	241	282	323	364	405	446	528	610	692

Ordering data

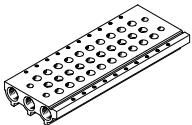

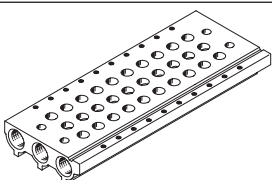

Technical data – Manifold rails								
	Port	CRC	Material ²⁾	Operating pressure		Max. tightening torque for assembly [Nm]		
	1, 3, 5			[MPa]	[bar]	Valve	H-rail	Wall
	G3/8	2 ¹⁾	Wrought aluminium alloy	-0.09 ... 1	-0.9 ... 10	1.18	1.5	3

1) More information www.festo.com/x/topic/crc

2) Information on materials: RoHS-compliant.

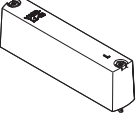
Ordering data – Manifold rail				
	Description		Part no.	Type
Manifold rail for in-line valve				
	For size G1/4	2 valve positions	★ 574455	VABM-L1-18S-G38-2
		3 valve positions	★ 574456	VABM-L1-18S-G38-3
		4 valve positions	★ 574457	VABM-L1-18S-G38-4
		5 valve positions	574458	VABM-L1-18S-G38-5
		6 valve positions	★ 574459	VABM-L1-18S-G38-6
		7 valve positions	574460	VABM-L1-18S-G38-7
		8 valve positions	★ 574461	VABM-L1-18S-G38-8
		9 valve positions	574462	VABM-L1-18S-G38-9
		10 valve positions	★ 574463	VABM-L1-18S-G38-10
		12 valve positions	574464	VABM-L1-18S-G38-12
		14 valve positions	574465	VABM-L1-18S-G38-14
		16 valve positions	574466	VABM-L1-18S-G38-16

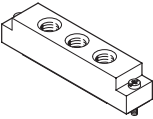
Ordering data

Ordering data – Accessories			
	Description	Part no.	Type
Cover plate Datasheets → Internet: vabb			
	For valve position on manifold rail, including screws and seal	★ 574482	VABB-L1-18
	For valve position on manifold rail, including screws and seal, suitable for battery manufacturing	8172852	VABB-L1-18-F1A
Separator Datasheets → Internet: vabd			
	For creating pressure zones	574483	VABD-14-B
	For creating pressure zones, suitable for battery manufacturing	8168590	VABD-14-B-F1A
Supply plate Datasheets → Internet: vabf			
	For valve position on manifold rail, including screws and seal	574481	VABF-L1-18-P3A4-G14
	For valve position on manifold rail, including screws and seal, suitable for battery manufacturing	8172851	VABF-L1-18-P3A4-G14-F1A
Seals for in-line valves Datasheets → Internet: vabd			
	For G1/4 in-line valves	Delivery quantity: 10 sets (each with 2 screws and 1 seal)	★ 574479
	For G1/4 in-line valves, suitable for battery manufacturing	Delivery quantity: 10 sets (each with 2 screws and 1 seal)	8172850
			VABD-L1-18X-S-G14
			VABD-L1-18X-S-G14-F1A

 **Note**



Connect supply plate at port 1 with compressed air.
Reverse operation (pressure at port 3, 5) is not permissible.

Datasheet

Function

5/2-way, single solenoid
5/2-way, double solenoid valve
5/3C, 5/3U, 5/3E

Circuit diagrams → page 14

-  - Size 10 mm
-  - Flow rate
80 ... 100 l/min
-  - Voltage
5, 12 and 24 V DC



General technical data VUVG-B						
Valve function	M52-R	B52	M52-M	P53		
Normal position	–	–	–	C ¹⁾	U ²⁾	E ³⁾
Stable position	Monostable	Bistable	Monostable	Monostable		
Pneumatic spring return	Yes ⁴⁾	–	No	–		
Mechanical spring return	Yes ⁴⁾	–	Yes	Yes		
Vacuum operation at port 1	Only with external pilot air supply					
Design	Piston spool					
Sealing principle	Soft					
Actuation type	Electrical					
Type of control	Piloted					
Pilot air supply	External, internal; can be selected via sub-base					
Exhaust air function	Can be throttled					
Manual override	Choice of non-detenting, covered, non-detenting/detenting or detenting					
Type of mounting	On manifold rail					
Mounting position	Any					
Nominal width	[mm]	2		1.4	2	
Standard nominal flow rate	[l/min]	100		80	90	
Flow rate on manifold rail M3	[l/min]	100		80	90	
Switching time on/off	[ms]	7/15	–	7/21	8/25	
Switching time changeover	[ms]	–	8	–	14	
Size	[mm]	10				
Port	1, 3, 5	M7 in manifold rail				
	2, 4	M5 in manifold rail				
	12/14, 82/84	M5 in manifold rail				
Product weight	[g]	38	49	37	49	
Certification	c UL us - Recognized (OL)					
	RCM					
CE marking (see declaration of conformity) ⁵⁾	To EU EMC Directive					
Corrosion resistance class CRC ⁶⁾	2					

1) C=Normally closed/mid-position closed

2) U=Normally open/mid-position pressurised

3) E=Mid-position exhausted

4) Combined reset method

5) For information about the area of use, see the EC declaration of conformity at: www.festo.com/catalogue/... → Support/Downloads.

If the devices are subject to usage restrictions in residential, commercial or light-industrial environments, further measures for the reduction of the emitted interference may be necessary.

6) More information www.festo.com/x/topic/crc

Datasheet

Operating and environmental conditions			M52-R ¹⁾	B52	M52-M ²⁾	P53
Valve function			Compressed air to ISO 8573-2010 [7:4:4]			
Operating pressure	Internal	[MPa]	0.25 ... 0.8	0.15 ... 0.8	0.3 ... 0.8	
		[bar]	2.5 ... 8	1.5 ... 8	3 ... 8	
	External	[MPa]	-0.09 ... 1		-0.09 ... 0.8	-0.09 ... 1
		[bar]	-0.9 ... 10		-0.9 ... 8	-0.9 ... 10
Pilot pressure		[MPa]	0.25 ... 0.8	0.15 ... 0.8	0.3 ... 0.8	
		[bar]	2.5 ... 8	1.5 ... 8	3 ... 8	
Ambient temperature		[°C]	-5 ... +50, with holding current reduction -5 ... +60			
Temperature of medium		[°C]	-5 ... +50, with holding current reduction -5 ... +60			

- 1) Combined pneumatic/mechanical spring
2) Mechanical spring

Electrical data	
Electrical connection	Via E-box → page 111
Operating voltage	[V DC] 5, 12 and 24 ±10%
Power	[W] 1, reduced to 0.35 with holding current reduction
Duty cycle	[%] 100
Protection rating to EN 60529	IP40 (with plug socket), IP65 (with M8)

Information on materials	
Housing	Wrought aluminium alloy
Seals	HNBR, NBR
Note on materials	RoHS-compliant
LABS (PWIS) conformity	VDMA24364-B1/B2-L

Dimensions

Download CAD data → www.festo.com

5/2- and 5/3-way valves

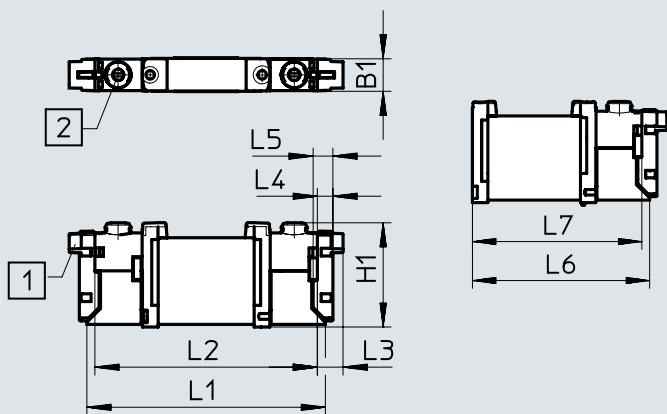

Note
More dimensions for
E-boxes
→ Page 113

- [1] Vertical electrical connection [2] Manual override

Type	B1	H1	L1	L2	L3	L4	L5	L6	L7
VUVG-B10A-...-F...	10.2	32.5	73.9	68.9	8	4.85	6.15	56.9	54.4

Ordering data

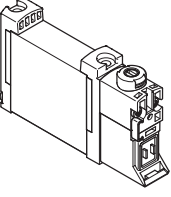
Ordering data	Description	Part no.	Type	
Sub-base valve M3, without E-box				
	5/2-way valve, single solenoid			
	External pilot air supply	Pneumatic/mechanical spring return	566448	VUVG-B10A-M52-RZT-F-1P3
		Mechanical spring return	574347	VUVG-B10A-M52-MZT-F-1P3
	5/2-way valve, double solenoid			
	External pilot air supply		566449	VUVG-B10A-B52-ZT-F-1P3
	5/3-way valve			
	External pilot air supply	Mid-position closed, mechanical spring return	566450	VUVG-B10A-P53C-ZT-F-1P3
		Mid-position exhausted, mechanical spring return	566451	VUVG-B10A-P53E-ZT-F-1P3
		Mid-position pressurised, mechanical spring return	566452	VUVG-B10A-P53U-ZT-F-1P3

Manifold assembly

Sub-base valve for manifold assembly
Connection M5

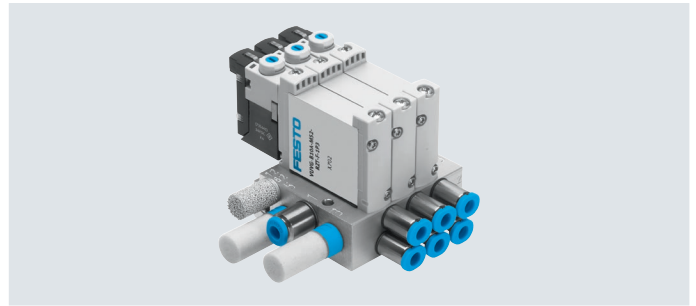

Dimensions

Download CAD data → www.festo.com

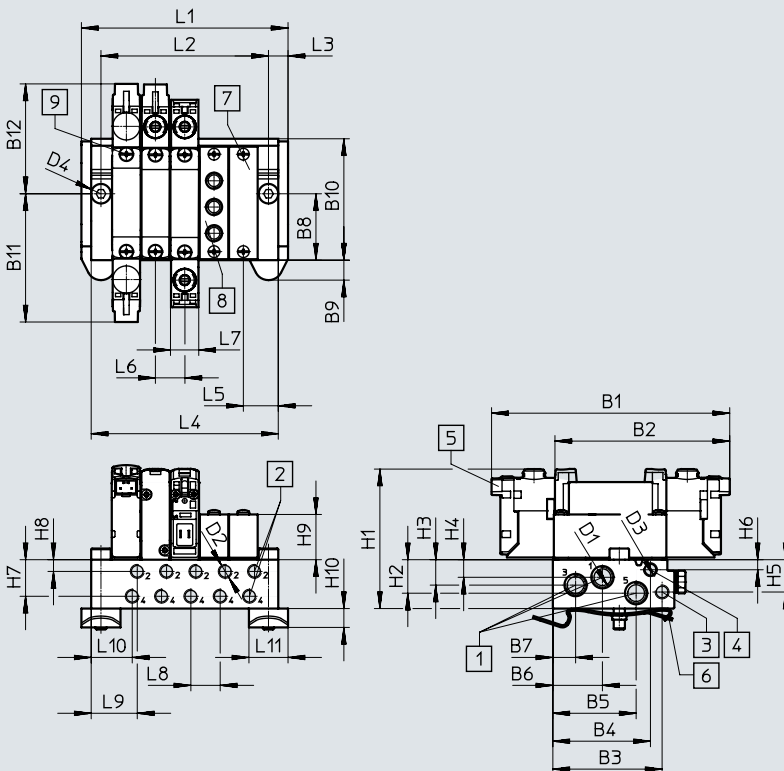

 **Note**
More dimensions for
E-boxes
→ Page 113

- [1] Ports 1, 3 and 5: M7 (at both ends)
- [2] Ports 2, 4: M5
- [3] Ports 12, 14: M5
- [4] Ports 82, 84: M5
- [5] Electrical connection for E-boxes and accessories
- [6] DIN rail mounting (two M4x25 screws are required for mounting)
- [7] Cover plate
- [8] Supply plate, ports 1, 3 and 5: M5
- [9] Valves/cover plate mounting on manifold rail: M2 thread

Type	B1	B2	B3	B4	B5	B6	B7	B8	B9	B10	B11	B12
VABM-L1-10AW-M7	84.9	62.4	39.1	35	29.8	17.8	8.2	24	7.2	43.5	45.8	39.2

Type	D1	D2	D3	D4	D5	H1	H2	H3	H4	H5	H6
VABM-L1-10AW-M7	M7	M5	M5	∅ 4.5	∅ 4	53.1	12	9.1	6.3	11.6	3.6

Type	H7	H8	H9	H10	H15	L3	L5	L6	L7	L8	L9	L10	L11
VABM-L1-10AW-M7	13.1	4.2	16.2	6.8	1.9	7.5	12.5	10.5	10.2	10.5	17	15.2	14

Valve positions	2	3	4	5	6	7	8	9	10	12	14	16
L1	43.5	54	64.5	75	85.5	97	107.5	117	127.5	148.5	169.5	190.5
L2	28.5	39	49.5	60	70.5	81	91.5	102	112.5	133.5	154.5	175.5
L4	36.5	47	57.5	68	78.5	89	99.5	110	120.5	141.5	162.5	183.5
VABM weight [g]	60	78	96	114	132	150	168	186	204	240	276	312

Ordering data

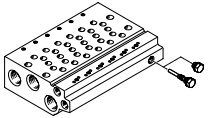



Technical data – Manifold rails ¹⁾	Port			CRC	Material ³⁾	Operating pressure		Max. tightening torque for assembly [Nm]		
	2, 4	1, 3, 5	12/14, 82/84			[MPa]	[bar]	Valve	H-rail	Wall
	M5	M7	M5	2 ²⁾	Wrought aluminium alloy	-0.09 ... 1	-0.9 ... 10	0.45	1.5	1.5

1) Blanking plugs are included with the manifold rail.

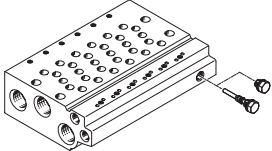
2) More information www.festo.com/x/topic/crc

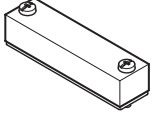
3) Information on materials: RoHS-compliant.

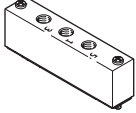
Ordering data – Manifold rails	Description	Part no.	Type
	For size B10A (M3)	2 valve positions	566546 VABM-L1-10AW-M7-2
		3 valve positions	566547 VABM-L1-10AW-M7-3
		4 valve positions	566548 VABM-L1-10AW-M7-4
		5 valve positions	566549 VABM-L1-10AW-M7-5
		6 valve positions	566550 VABM-L1-10AW-M7-6
		7 valve positions	566551 VABM-L1-10AW-M7-7
		8 valve positions	566552 VABM-L1-10AW-M7-8
		9 valve positions	566553 VABM-L1-10AW-M7-9
		10 valve positions	566554 VABM-L1-10AW-M7-10
		12 valve positions	566555 VABM-L1-10AW-M7-12
		14 valve positions	566556 VABM-L1-10AW-M7-14
16 valve positions	566557 VABM-L1-10AW-M7-16		

Ordering data – Accessories	Description	Part no.	Type
	For valve position on manifold rail, including screws and seal	569986	Datasheets → Internet: vabb
			VABB-L1-10A
	For creating pressure zones	570872	Datasheets → Internet: vabd
			VABD-4.2-B
	For valve position on manifold rail, including screws and seal	569990	Datasheets → Internet: vabf
			VABF-L1-10A-P3A4-M5
	For sub-base valve M3	Delivery quantity: 10 sets (each with 2 screws and 1 seal)	Datasheets → Internet: vabd
			566671 VABD-L1-10AB-S-M3

Datasheet

Function

2x 3/2C

5/2-way, single solenoid

5/2-way, double solenoid valve

Circuit diagrams → page 14

-  - Size 10 mm

-  - Flow rate
160 l/min

-  - Voltage
24 V DC

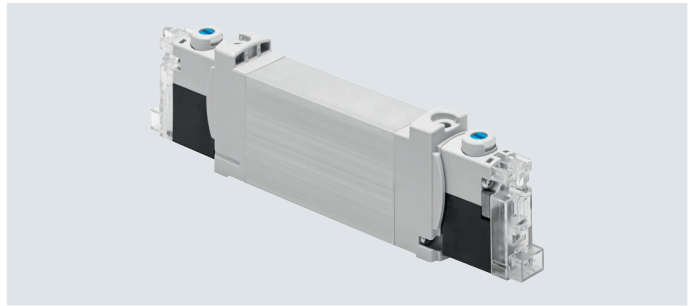

General technical data VUVG-BK

Valve function	T32-A	M52-A	B52	
Normal position	C ¹⁾	-	-	
Stable position	Monostable		Bistable	
Pneumatic spring return	Yes	Yes	-	
Design	Piston spool			
Sealing principle	Soft			
Actuation type	Electrical			
Type of control	Piloted			
Pilot air supply	Internal			
Exhaust air function	Can be throttled			
Manual override	Non-detenting, detenting			
Type of mounting	On manifold rail			
Mounting position	Any			
Standard nominal flow rate	[l/min]	160	160	160
Switching time on/off	[ms]	12/14	14/17	-
Switching time changeover	[ms]	-		8
Size	[mm]	10		
Port	2, 4	M5/M7 in manifold rail		
Product weight	[g]	55	45	57
Corrosion resistance class CRC ²⁾		0		
Certificate-issuing authority		UL MH19482		
Certification		c UL us - Recognized (OL)		

1) C = Normally closed

2) More information www.festo.com/x/topic/crc

Safety characteristics

Max. positive test pulse with logic 0	[μs]	1600
Max. negative test pulse with logic 1	[μs]	3000
Shock resistance		Shock test with severity level 1 to FN 942017-5 and EN 60068-2-27
Vibration resistant		Transport application test with severity level 1 to FN 942017-4 and EN 60068-2-6

Datasheet

Operating and environmental conditions				
Valve function		T32-A ¹⁾	M52-A ¹⁾	B52
Operating medium		Compressed air to ISO 8573-2010 [7:4:4]		
Note on the operating/pilot medium		Lubricated operation possible (in which case lubricated operation will always be required)		
Operating pressure	[MPa]	0.15 ... 0.7	0.25 ... 0.7	0.15 ... 0.7
	[bar]	1.5 ... 7	2.5 ... 7	1.5 ... 7
Ambient temperature	[°C]	-5 ... +50		
Temperature of medium	[°C]	-5 ... +50		

1) Pneumatic spring

Electrical data				
Electrical connection		Via E-box → page 111		
Operating voltage	[V DC]	24 ±10%		
Nominal operating voltage	[V DC]	22		
Power	[W]	0.7		
Duty cycle	[%]	100		
Protection rating to EN 60529		IP40 (with plug socket), IP65 (with M8)		
Signal status display		LED		
Maximum switching frequency	[Hz]	2		

Information on materials	
Housing	Wrought aluminium alloy
Seals	HNBR, NBR
Note on materials	RoHS-compliant
LABS (PWIS) conformity	VDMA24364 zone III

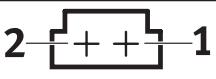
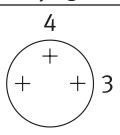
Pin allocation for E-box			
	Pin		Description
Rectangular plug, connection pattern H			
	1	+ or -	Protective circuit without holding current reduction
	2	+ or -	
Round plug, M8, 3-pin			
	1	Not used	Protective circuit without holding current reduction
	3	+ or -	
	4	+ or -	

Protective circuit without holding current reduction

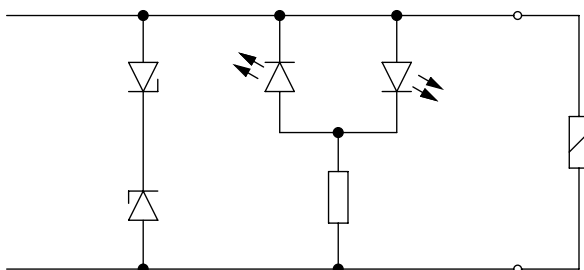

The solenoid coils have a protective circuit to arrest sparks and protect against polarity reversal.

Datasheet

Dimensions

Download CAD data → www.festo.com

2x 3/2-way, 5/2-way valve, double solenoid

5/2-way valve, single solenoid

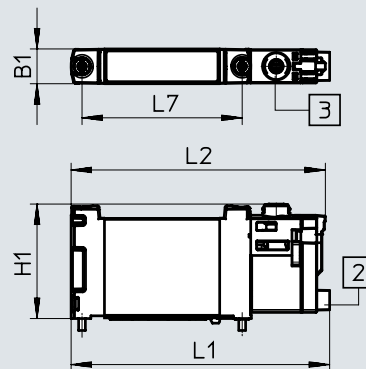
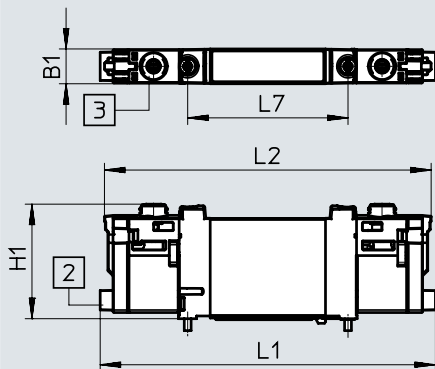

 **Note**
More dimensions for
E-boxes
→ Page 113

[2] Horizontal electrical connection [3] Manual override

Type	B1	H1	L1	L2	L7
VUVG-BK10-T32C...	10.2	33.6	98.3	95.8	47
VUVG-BK10-B52...					
VUVG-BK10-M52...			75.9	74.6	

Ordering data

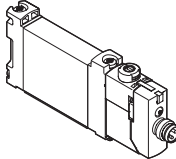
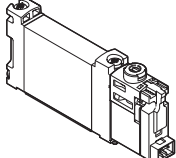

★ Core Range

Ordering data	Description	Part no.	Type	
Sub-base valve M5/M7, with E-box R8				
	2x 3/2-way valve			
	Internal pilot air supply	Normally closed, pneumatic spring return	★ 8042558	VUVG-BK10-T32C-AT-F-1R8L-S
	5/2-way valve, single solenoid			
	Internal pilot air supply	Pneumatic spring return	★ 8042559	VUVG-BK10-M52-AT-F-1R8L-S
	5/2-way valve, double solenoid			
	Internal pilot air supply		★ 8042560	VUVG-BK10-B52-T-F-1R8L-S
Sub-base valve M5/M7, with E-box H2				
	2x 3/2-way valve			
	Internal pilot air supply	Normally closed, pneumatic spring return	★ 8042554	VUVG-BK10-T32C-AT-F-1H2L-S
	5/2-way valve, single solenoid			
	Internal pilot air supply	Pneumatic spring return	★ 8042555	VUVG-BK10-M52-AT-F-1H2L-S
	5/2-way valve, double solenoid			
	Internal pilot air supply		★ 8042556	VUVG-BK10-B52-T-F-1H2L-S

Datasheet

Function

2x 3/2C, 2x 3/2U, 2x 3/2H
 5/2-way, single solenoid
 5/2-way, double solenoid valve
 5/3C, 5/3U, 5/3E

-  - Size 10 mm
-  - Flow rate
120 ... 330 l/min
-  - Voltage
5, 12 and 24 V DC

Circuit diagrams → page 14



General technical data VUVG-B

Valve function	T32-A			T32-M			M52-R	B52	M52-M	P53		
	C ¹⁾	U ²⁾	H ⁴⁾	C ¹⁾	U ²⁾	H ⁴⁾	–	–	–	C ¹⁾	U ²⁾	E ³⁾
Normal position	C ¹⁾	U ²⁾	H ⁴⁾	C ¹⁾	U ²⁾	H ⁴⁾	–	–	–	C ¹⁾	U ²⁾	E ³⁾
Stable position	Monostable							Bistable	Monostable	Monostable		
Pneumatic spring return	Yes			No			Yes ⁵⁾	–	No	–		
Mechanical spring return	No			Yes			Yes ⁵⁾	–	Yes	Yes		
Vacuum operation at port 1	No			Only with external pilot air supply								
Design	Piston spool											
Sealing principle	Soft											
Actuation type	Electrical											
Type of control	Piloted											
Pilot air supply	External, internal; can be selected via sub-base											
Exhaust air function	Can be throttled											
Manual override	Choice of non-detenting, covered, non-detenting/detenting or detenting											
Type of mounting	On manifold rail											
Mounting position	Any											
Nominal width [mm]	2.7			1.8	1.7		4		2.3		3.5	
Standard nominal flow rate [l/min]	170			150	140	140		330		285		300
Flow rate on manifold rail M5 [l/min]	150			130	120	120		210		180		200
Flow rate on manifold rail M7 [l/min]	160			140	130	130		270		230		250
Switching time on/off [ms]	6/15			8/11			7/17		–	8/24		11/30
Switching time changeover [ms]	–							8		14		
Size [mm]	10											
Port	1, 3, 5			G1/8 in manifold rail								
	2, 4			M5 or M7 in manifold rail								
	12/14, 82/84			M5 in manifold rail								
Product weight [g]	55			54			45	55	44	55		
Certification	c UL us - Recognized (OL)											
	RCM											
CE marking (see declaration of conformity) ⁶⁾	To EU EMC Directive											
Corrosion resistance class CRC ⁷⁾	2											

1) C=Normally closed/mid-position closed

2) U=Normally open/mid-position pressurised

3) E=Mid-position exhausted

4) H=2x 3/2-way valve in one housing with 1x normally closed and 1x normally open

5) Combined reset method

6) For information about the area of use, see the EC declaration of conformity at: www.festo.com/catalogue/... → Support/Downloads.

If the devices are subject to usage restrictions in residential, commercial or light-industrial environments, further measures for the reduction of the emitted interference may be necessary.

7) More information www.festo.com/x/topic/crc

Datasheet

Operating and environmental conditions			T32-A ¹⁾	T32-M ³⁾	M52-R ²⁾	B52	M52-M ³⁾	P53
Valve function			Compressed air to ISO 8573-2010 [7:4:4]					
Operating pressure	Internal	[MPa]	0.15 ... 0.8	0.25 ... 0.8	0.25 ... 0.8	0.15 ... 0.8	0.3 ... 0.8	
		[bar]	1.5 ... 8	2.5 ... 8	2.5 ... 8	1.5 ... 8	3 ... 8	
	External	[MPa]	0.15 ... 1	-0.09 ... 1			-0.09 ... 0.8	-0.09 ... 1
		[bar]	1.5 ... 10	-0.9 ... 10			-0.9 ... 8	-0.9 ... 10
Pilot pressure		[MPa]	0.15 ... 0.8	0.2 ... 0.8	0.25 ... 0.8	0.15 ... 0.8	0.3 ... 0.8	
		[bar]	1.5 ... 8	2 ... 8	2.5 ... 8	1.5 ... 8	3 ... 8	
Ambient temperature		[°C]	-5 ... +50, with holding current reduction -5 ... +60					
Temperature of medium		[°C]	-5 ... +50, with holding current reduction -5 ... +60					

- 1) Pneumatic spring
- 2) Combined pneumatic/mechanical spring
- 3) Mechanical spring

Electrical data	
Electrical connection	Via E-box → page 111
Operating voltage	[V DC] 5, 12 and 24 ±10%
Power	[W] 1, reduced to 0.35 with holding current reduction
Duty cycle	[%] 100
Protection rating to EN 60529	IP40 (with plug socket), IP65 (with M8)

Information on materials	
Housing	Wrought aluminium alloy
Seals	HNBR, NBR
Note on materials	RoHS-compliant
LABS (PWIS) conformity	VDMA24364-B1/B2-L

Dimensions

Download CAD data → www.festo.com

2x 3/2-way, 5/2-way and 5/3-way valve

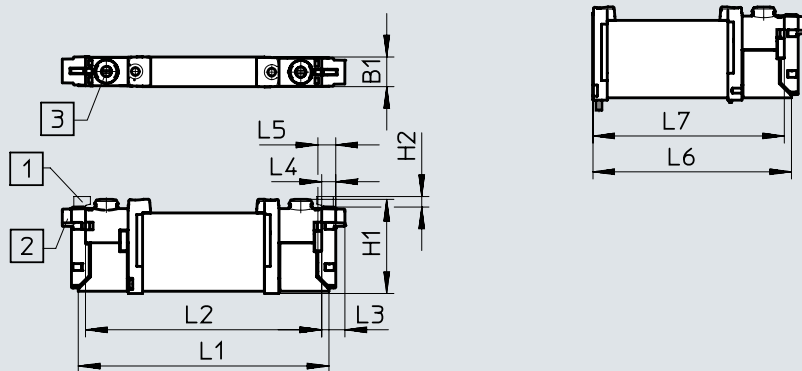

Note
More dimensions for E-boxes
→ Page 113

- [1] Vertical electrical connection
- [2] Horizontal electrical connection
- [3] Manual override

Type	B1	H1	H2	L1	L2	L3	L4	L5	L6	L7
VUVG-B10 -...-F...	10.2	32.5	3.6	86.5	81.5	8	4.85	6.15	69.2	66.7

Ordering data

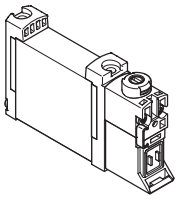
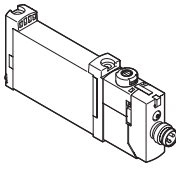
Ordering data	Description	Part no.	Type	
Sub-base valve M5/M7, without E-box				
	2x 3/2-way valve			
	External pilot air supply	Normally closed, pneumatic spring return	566487	VUVG-B10-T32C-AZT-F-1P3
		Normally open, pneumatic spring return	566488	VUVG-B10-T32U-AZT-F-1P3
		1x normally open, 1x normally closed, pneumatic spring return	566489	VUVG-B10-T32H-AZT-F-1P3
		Normally closed, mechanical spring return	574364	VUVG-B10-T32C-MZT-F-1P3
		Normally open, mechanical spring return	574365	VUVG-B10-T32U-MZT-F-1P3
		1x normally open, 1x normally closed, mechanical spring return	574366	VUVG-B10-T32H-MZT-F-1P3
	5/2-way valve, single solenoid			
	External pilot air supply	Pneumatic/mechanical spring return	566490	VUVG-B10-M52-RZT-F-1P3
		Mechanical spring return	574367	VUVG-B10-M52-MZT-F-1P3
	5/2-way valve, double solenoid			
	External pilot air supply		566491	VUVG-B10-B52-ZT-F-1P3
	5/3-way valve			
External pilot air supply	Mid-position closed, mechanical spring return	566492	VUVG-B10-P53C-ZT-F-1P3	
	Mid-position exhausted, mechanical spring return	566493	VUVG-B10-P53E-ZT-F-1P3	
	Mid-position pressurised, mechanical spring return	566494	VUVG-B10-P53U-ZT-F-1P3	
Sub-base valve M5/M7, with E-box R8				
	2x 3/2-way valve			
	External pilot air supply	Normally closed, pneumatic spring return	574234	VUVG-B10-T32C-AZT-F-1R8L
		Normally open, pneumatic spring return	574235	VUVG-B10-T32U-AZT-F-1R8L
		1x normally open, 1x normally closed, pneumatic spring return	574236	VUVG-B10-T32H-AZT-F-1R8L
		Normally closed, mechanical spring return	8031492	VUVG-B10-T32C-MZT-F-1R8L
		Normally open, mechanical spring return	8031493	VUVG-B10-T32U-MZT-F-1R8L
		1x normally open, 1x normally closed, mechanical spring return	8031494	VUVG-B10-T32H-MZT-F-1R8L
	5/2-way valve, single solenoid			
	External pilot air supply	Pneumatic/mechanical spring return	574237	VUVG-B10-M52-RZT-F-1R8L
		Mechanical spring return	578157	VUVG-B10-M52-MZT-F-1R8L
	5/2-way valve, double solenoid			
	External pilot air supply		574238	VUVG-B10-B52-ZT-F-1R8L
	5/3-way valve			
External pilot air supply	Mid-position closed, mechanical spring return	574239	VUVG-B10-P53C-ZT-F-1R8L	
	Mid-position exhausted, mechanical spring return	574241	VUVG-B10-P53E-ZT-F-1R8L	
	Mid-position pressurised, mechanical spring return	574240	VUVG-B10-P53U-ZT-F-1R8L	

Manifold assembly

Sub-base valve for manifold assembly
M5 or M7 connection

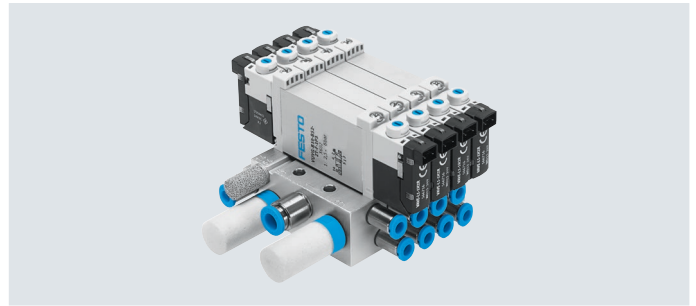

Dimensions

Download CAD data → www.festo.com

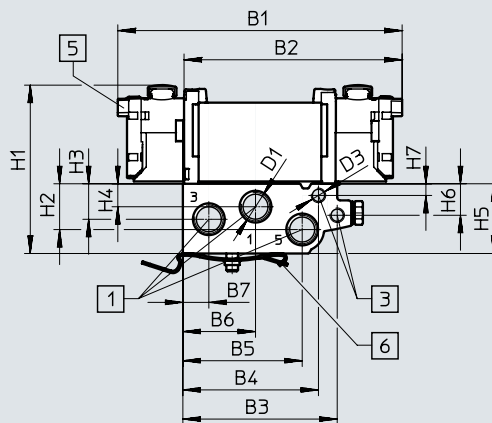
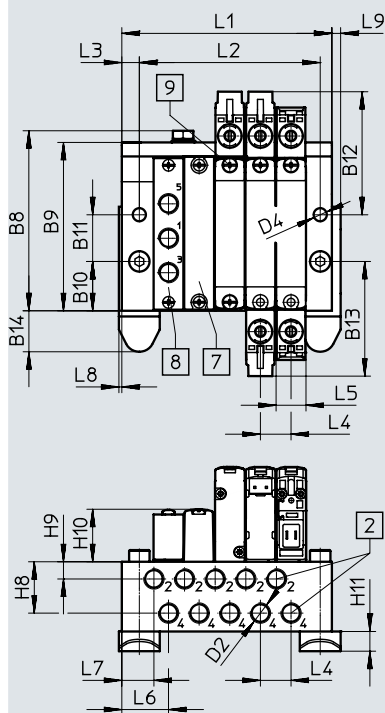

Note
More dimensions for E-boxes
→ Page 113

- [1] Ports 1, 3 and 5: G1/8 (at both ends)
- [2] Ports 2, 4: M7 or M5
- [3] Ports 12, 14: M5
- [5] Electrical connection for E-boxes and accessories
- [6] DIN rail mounting (two M4x30 screws are required for mounting)
- [7] Cover plate
- [8] Supply plate, ports 1, 3 and 5: either M5 or M7
- [9] Valves/cover plate mounting on manifold rail: M2 thread

Type	B1	B2	B3	B4	B5	B6	B7	B8	B9	B10	B11	B12
VABM-L1 10-...-G18	97.5	74.8	52.9	46.5	40.9	24.9	8.9	61.7	57.7	16.9	16	42.2

Type	B13	B14	D1	D2	D3	D4	D5	H1	H2	H3	H4
VABM-L1 10-...-G18	39.3	14.1	G1/8	M5/M7	M5	4.5	∅6	56.4	15.7	12.2	7.9

Type	H5	H6	H7	H8	H9	H10	H11	L3	L4	L5	L6	L7	L8	L9
VABM-L1 10-...-G18	23.9	10.8	4	17.6	5.9	18	6.8	6	10.5	10.3	16	11.9	1	3

Valve positions	2	3	4	5	6	7	8	9	10	12	14	16	22
L1	40.5	51	61.5	72	82.5	93	103.5	114	124.5	145.5	166.5	187.5	250.5
L2	30.5	41	51.5	62	72.5	83	93.5	104	114.5	135.5	156.5	177.5	240.5
VABM weight [g]	107	135	163	191	219	247	275	303	331	387	415	471	499

Manifold assembly

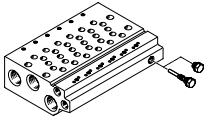
	Port			CRC	Material ³⁾	Operating pressure		Max. tightening torque for assembly [Nm]		
	2, 4	1, 3, 5	12/14, 82/84			[MPa]	[bar]	Valve	H-rail	Wall
	M5 or M7	G1/8	M5	2 ²⁾	Wrought aluminium alloy	-0.09 ... 1	-0.9 ... 10	0.45	1.5	3



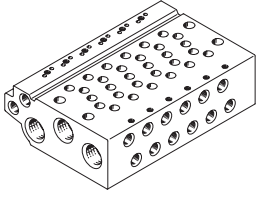

1) Blanking plugs are included with the manifold rail.

2) More information www.festo.com/x/topic/crc

3) Information on materials: RoHS-compliant.

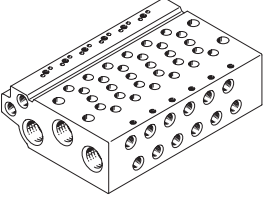
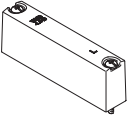
Ordering data – Manifold rails		Description	Part no.	Type
Manifold rail for sub-base valve M5/M7				
	For size B10 (M5)	2 valve positions	★ 566582	VABM-L1-10W-G18-2
		3 valve positions	★ 566583	VABM-L1-10W-G18-3
		4 valve positions	★ 566584	VABM-L1-10W-G18-4
		5 valve positions	566585	VABM-L1-10W-G18-5
		6 valve positions	★ 566586	VABM-L1-10W-G18-6
		7 valve positions	566587	VABM-L1-10W-G18-7
		8 valve positions	★ 566588	VABM-L1-10W-G18-8
		9 valve positions	566589	VABM-L1-10W-G18-9
		10 valve positions	★ 566590	VABM-L1-10W-G18-10
		12 valve positions	566591	VABM-L1-10W-G18-12
		14 valve positions	566592	VABM-L1-10W-G18-14
16 valve positions	566593	VABM-L1-10W-G18-16		

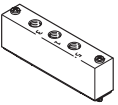
Manifold assembly

Ordering data – Accessories				Part no.	Type
Description					
Manifold rail for sub-base valve M5/M7					
	For size B10 (M7)	2 valve positions	★ 566606	VABM-L1-10HW-G18-2	
		3 valve positions	★ 566607	VABM-L1-10HW-G18-3	
		4 valve positions	★ 566608	VABM-L1-10HW-G18-4	
		5 valve positions	566609	VABM-L1-10HW-G18-5	
		6 valve positions	★ 566610	VABM-L1-10HW-G18-6	
		7 valve positions	566611	VABM-L1-10HW-G18-7	
		8 valve positions	★ 566612	VABM-L1-10HW-G18-8	
		9 valve positions	566613	VABM-L1-10HW-G18-9	
		10 valve positions	★ 566614	VABM-L1-10HW-G18-10	
		12 valve positions	566615	VABM-L1-10HW-G18-12	
14 valve positions	566616	VABM-L1-10HW-G18-14			
16 valve positions	566617	VABM-L1-10HW-G18-16			
Cover plate Datasheets → Internet: vabb					
	For valve position on manifold rail, including screws and seal		★ 566495	VABB-L1-10-W	
Separator Datasheets → Internet: vabd					
	For creating pressure zones		569994	VABD-6-B	
Supply plate Datasheets → Internet: vabf					
	For valve position (sub-base valves M5) on manifold rail, including screws and seal		569991	VABF-L1-10-P3A4-M5	
	For valve position (sub-base valves M7) on manifold rail, including screws and seal		569992	VABF-L1-10-P3A4-M7	
Seals Datasheets → Internet: vabd					
	Only suitable for VUVG-B10	For sub-base valves M5/M7	Delivery quantity: 10 sets (each with 2 screws and 1 seal)	566674	VABD-L1-10B-S-M7

Datasheet

Function

2x 3/2C

5/2-way, single solenoid

5/2-way, double solenoid valve

Circuit diagrams → page 14

-  - Size 14 mm

-  - Flow rate
350 ... 380 l/min

-  - Voltage
24 V DC

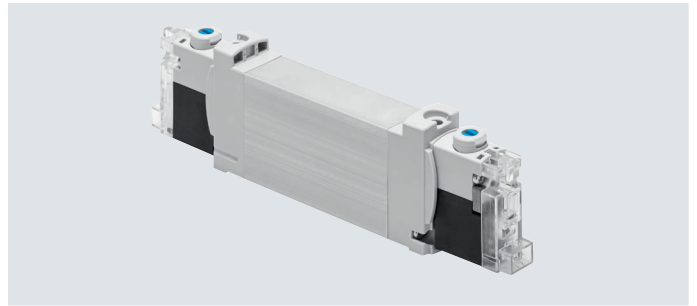

General technical data VUVG-BK

Valve function	T32-A	M52-A	B52	
Normal position	C ¹⁾	–	–	
Stable position	Monostable		Bistable	
Pneumatic spring return	Yes	Yes	–	
Design	Piston spool			
Sealing principle	Soft			
Actuation type	Electrical			
Type of control	Piloted			
Pilot air supply	Internal			
Exhaust air function	Can be throttled			
Manual override	Non-detenting, detenting			
Type of mounting	On manifold rail			
Mounting position	Any			
Standard nominal flow rate	[l/min]	350	380	380
Switching time on/off	[ms]	13/20	14/24	–
Switching time changeover	[ms]	–		8
Size	[mm]	14		
Port	2, 4	G1/8 in manifold rail		
Product weight	[g]	75	65	85
Corrosion resistance class CRC ²⁾		0		
Certificate-issuing authority		UL MH19482		
Certification		c UL us - Recognized (OL)		

1) C = Normally closed

2) More information www.festo.com/x/topic/crc

Safety characteristics

Max. positive test pulse with logic 0	[μs]	1600
Max. negative test pulse with logic 1	[μs]	3000
Shock resistance		Shock test with severity level 1 to FN 942017-5 and EN 60068-2-27
Vibration resistant		Transport application test with severity level 1 to FN 942017-4 and EN 60068-2-6

Datasheet

Operating and environmental conditions			
Valve function		T32-A ¹⁾	M52-A ¹⁾
Operating medium		Compressed air to ISO 8573-2010 [7:4:4]	
Note on the operating/pilot medium		Lubricated operation possible (in which case lubricated operation will always be required)	
Operating pressure	[MPa]	0.15 ... 0.7	0.25 ... 0.7
	[bar]	1.5 ... 7	2.5 ... 7
Ambient temperature	[°C]	-5 ... +50	
Temperature of medium	[°C]	-5 ... +50	

1) Pneumatic spring

Electrical data		
Electrical connection		Via E-box → page 111
Operating voltage	[V DC]	24 ±10%
Nominal operating voltage	[V DC]	22
Power	[W]	0.7
Duty cycle	[%]	100
Protection rating to EN 60529		IP40 (with plug socket), IP65 (with M8)
Signal status display		LED
Maximum switching frequency	[Hz]	2

Information on materials	
Housing	Wrought aluminium alloy
Seals	HNBR, NBR
Note on materials	RoHS-compliant
LABS (PWIS) conformity	VDMA24364 zone III

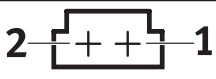
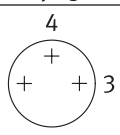
Pin allocation for E-box		
	Pin	Description
Rectangular plug, connection pattern H		
	1	+ or -
	2	+ or -
Round plug, M8, 3-pin		
	1	Not used
	3	+ or -
	4	+ or -

Protective circuit without holding current reduction

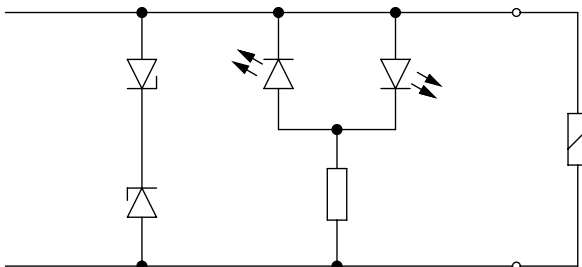

The solenoid coils have a protective circuit to arrest sparks and protect against polarity reversal.

Datasheet

Download CAD data → www.festo.com

Dimensions

2x 3/2-way, 5/2-way valve, single solenoid

5/2-way valve, double-solenoid

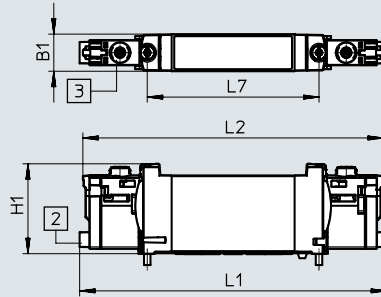
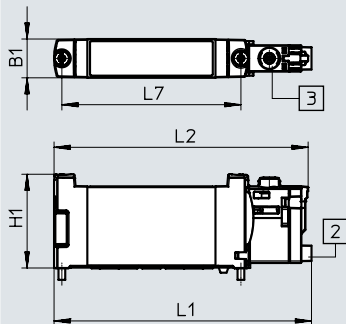

Note
More dimensions for E-boxes
→ Page 113

[2] Horizontal electrical connection

[3] Manual override

Type	B1	H1	L1	L2	L7
VUVG-BK14-T32C-...	14.4	34.8	118.9	116.4	66.5
VUVG-BK14-B52-...					
VUVG-BK14-M52-...			95.6	94.4	

Ordering data





★ Core Range

Ordering data	Description	Part no.	Type
Sub-base valve G1/8, with E-box R8			
	2x 3/2-way valve		
	Internal pilot air supply	Normally closed, pneumatic spring return	★ 8042574 VUVG-BK14-T32C-AT-F-1R8L-S
	5/2-way valve, single solenoid		
	Internal pilot air supply	Pneumatic spring return	★ 8042575 VUVG-BK14-M52-AT-F-1R8L-S
	5/2-way valve, double solenoid		
	Internal pilot air supply		★ 8042576 VUVG-BK14-B52-T-F-1R8L-S
Sub-base valve G1/8, with E-box H2			
	2x 3/2-way valve		
	Internal pilot air supply	Normally closed, pneumatic spring return	★ 8042570 VUVG-BK14-T32C-AT-F-1H2L-S
	5/2-way valve, single solenoid		
	Internal pilot air supply	Pneumatic spring return	★ 8042571 VUVG-BK14-M52-AT-F-1H2L-S
	5/2-way valve, double solenoid		
	Internal pilot air supply		★ 8042572 VUVG-BK14-B52-T-F-1H2L-S

Datasheet

Function

2x 3/2C, 2x 3/2U, 2x 3/2H
 5/2-way, single solenoid
 5/2-way, double solenoid valve
 5/3C, 5/3U, 5/3E

-  Size 14 mm
-  Flow rate
410 ... 680 l/min
-  Voltage
5, 12 and 24 V DC
24, 110 and 230 V AC
-  Voltage VUVG-...-P1
12 and 24 V DC
24, 110 and 230 V AC



Circuit diagrams → page 14

General technical data VUVG-B

Valve function	T32-A			T32-M			M52-A	B52	M52-M	P53		
Normal position	C ¹⁾	U ²⁾	H ⁴⁾	C ¹⁾	U ²⁾	H ⁴⁾	–	–	–	C ¹⁾	U ²⁾	E ³⁾
Stable position	Monostable							Bistable	Monostable	Monostable		
Pneumatic spring return	Yes			No			Yes	–	No	–		
Mechanical spring return	No			Yes			No	–	Yes	Yes		
Vacuum operation at port 1	No			Only with external pilot air supply								
Size [mm]	14											
Design	Piston spool											
Sealing principle	Soft											
Actuation type	Electrical											
Type of control	Piloted											
Pilot air supply	External, internal; can be selected via sub-base											
Exhaust air function	Can be throttled											
Manual override	VUVG-...	Choice of non-detenting, covered, non-detenting/detenting or detenting										
	VUVG-...-P1	Non-detenting, non-detenting/detenting										
Type of mounting	On manifold rail											
Mounting position	Any											
Nominal width [mm]	4.6			4.3			5.6					
Standard nominal flow rate [l/min]	600	580		470	450		630	680	630	600	580	580
Flow rate on manifold rail G1/8 [l/min]	510			430	410		520	570		520	500	460
Switching time												
VUVG-...	On/off [ms]	9/25			12/18			14/22	–	13/37	12/40	
	Changeover [ms]	–			–			–	8	–	20	
VUVG-...-P1	On/off [ms]	11/18			14/13			16/16	–	12/26	14/24	
	Changeover [ms]	–			–			–	12	–	19	
Pneumatic connection	1, 3, 5	G1/4 in manifold rail										
	2, 4	G1/8 in manifold rail										
	12/14, 82/84	M5 in manifold rail										
Product weight [g]	VUVG-...	89			80			78	89	70	89	
	VUVG-...-P1	65			56			66	65	58	65	
Certificate-issuing authority	VUVG-...-P1	UL MH19482										
Certification	VUVG-...	RCM										
	VUVG-...	c UL us - Recognized (OL)										
	VUVG-...-P1	–										
CE marking (see declaration of conformity) ⁵⁾	To EU EMC Directive											
	To EU Low Voltage Directive											
Corrosion resistance class CRC ⁶⁾	2											

1) C=Normally closed/mid-position closed

2) U=Normally open/mid-position pressurised

3) E=Mid-position exhausted

4) H=2x 3/2-way valve in one housing with 1x normally closed and 1x normally open

5) For information about the area of use, see the EC declaration of conformity at: www.festo.com/catalogue/... → Support/Downloads.

If the devices are subject to usage restrictions in residential, commercial or light-industrial environments, further measures for the reduction of the emitted interference may be necessary.

6) More information www.festo.com/x/topic/crc

Datasheet

Operating and environmental conditions			T32-A ¹⁾	T32-M ²⁾	M52-A ¹⁾	B52	M52-M ²⁾	P53	
Valve function			Compressed air to ISO 8573-2010 [7:4:4]						
Note on the operating/pilot medium			Lubricated operation possible (in which case lubricated operation will always be required)						
Operating pressure	Internal VUVG-...	[MPa]	0.15 ... 0.8	0.35 ... 0.8	0.25 ... 0.8	0.15 ... 0.8	0.3 ... 0.8		
		[bar]	1.5 ... 8	3.5 ... 8	2.5 ... 8	1.5 ... 8	3 ... 8		
	External	[MPa]	0.15 ... 1	-0.09 ... 1				-0.09 ... 0.8	-0.09 ... 1
		[bar]	1.5 ... 10	-0.9 ... 10				-0.9 ... 8	-0.9 ... 10
Pilot pressure ³⁾		[MPa]	0.15 ... 0.8	0.3 ... 0.8	0.25 ... 0.8	0.15 ... 0.8	0.3 ... 0.8		
		[bar]	1.5 ... 8	3 ... 8	2.5 ... 8	1.5 ... 8	3 ... 8		
Ambient temperature	VUVG-...	[°C]	-5 ... +50, with holding current reduction -5 ... +60						
	VUVG-...-P1	[°C]	-5 ... +50 for mounting on manifold rail -5 ... +60						
Temperature of medium	VUVG-...	[°C]	-5 ... +50, with holding current reduction -5 ... +60						
	VUVG-...-P1	[°C]	-5 ... +50 for mounting on manifold rail -5 ... +60						

1) Pneumatic spring

2) Mechanical spring

3) Minimum pilot pressure 50% of operating pressure

Electrical data			
Electrical connection	VUVG-...		Via E-box → page 111
	VUVG-...-P1		Via electric pilot valve
Pilot interface	VUVG-...-P1		To ISO 15218
Operating voltage	VUVG-...	[V DC]	5, 12 and 24 ±10%
	VUVG-...-P1	[V DC]	12 and 24 ±10%
		[V AC]	24, 110 and 230 ±10%
Power	VUVG-...	[W]	1, reduced to 0.35 with holding current reduction
	VUVG-...-P1	[W]	1.3
Duty cycle		[%]	100
Protection rating to EN 60529			
	VUVG-...		IP40 (with plug socket), IP65 (with M8)
	VUVG-...-P1		IP65, with electric pilot valve and plug socket

Information on materials	
Housing	Wrought aluminium alloy
Seals	HNBR, NBR
Note on materials	RoHS-compliant
LABS (PWIS) conformity	VDMA24364-B1/B2-L

Datasheet

Dimensions VUVG

Download CAD data → www.festo.com

2x 3/2-way, 5/2-way and 5/3-way valve

5/2-way valve, single solenoid

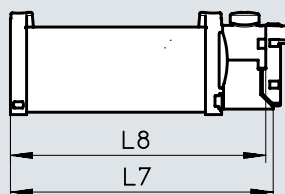
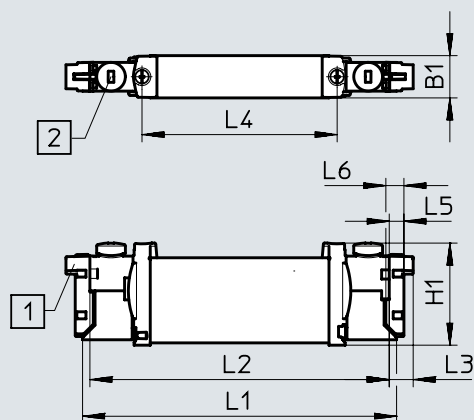

Note
More dimensions for E-boxes
→ Page 113

[1] Horizontal electrical connection [2] Manual override

Type	B1	H1	L1	L2	L3	L4	L5	L6	L7	L8
VUVG-B14 -...-F...	14	34.8	107	102	8	66.5	4.9	6.2	89.5	87

Dimensions VUVG-...-P1

2x 3/2-way, 5/2-way and 5/3-way valve

5/2-way valve, single solenoid

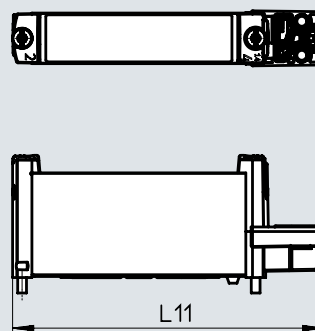
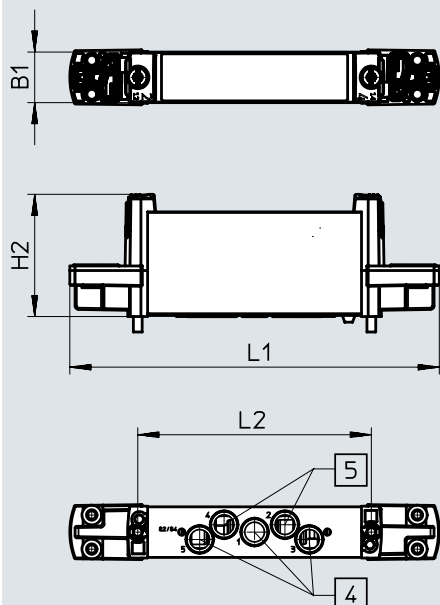

[4] Ports 1, 3 and 5 [5] Ports 2 and 4

Type	B1	H2	L1	L2	L11
VUVG-B14-...-P1	14.4	34.8	105.2	66.5	88.6

Ordering data

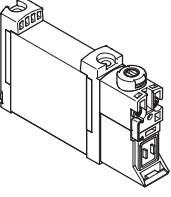
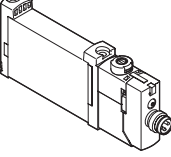
Ordering data	Description	Part no.	Type	
Sub-base valve G1/8, without E-box				
	2x 3/2-way valve			
	External pilot air supply	Normally closed, pneumatic spring return	566513	VUVG-B14-T32C-AZT-F-1P3
		Normally open, pneumatic spring return	566514	VUVG-B14-T32U-AZT-F-1P3
		1x normally open, 1x normally closed, pneumatic spring return	566515	VUVG-B14-T32H-AZT-F-1P3
		Normally closed, mechanical spring return	574376	VUVG-B14-T32C-MZT-F-1P3
		Normally open, mechanical spring return	574377	VUVG-B14-T32U-MZT-F-1P3
		1x normally open, 1x normally closed, mechanical spring return	574378	VUVG-B14-T32H-MZT-F-1P3
	5/2-way valve, single solenoid			
	External pilot air supply	Pneumatic spring return	566516	VUVG-B14-M52-AZT-F-1P3
		Mechanical spring return	574379	VUVG-B14-M52-MZT-F-1P3
	5/2-way valve, double solenoid			
	External pilot air supply		566517	VUVG-B14-B52-ZT-F-1P3
	5/3-way valve			
	External pilot air supply	Mid-position closed, mechanical spring return	566518	VUVG-B14-P53C-ZT-F-1P3
Mid-position exhausted, mechanical spring return		566519	VUVG-B14-P53E-ZT-F-1P3	
Mid-position pressurised, mechanical spring return		566520	VUVG-B14-P53U-ZT-F-1P3	
Sub-base valve G1/8, with E-box R8				
	2x 3/2-way valve			
	External pilot air supply	Normally closed, pneumatic spring return	574242	VUVG-B14-T32C-AZT-F-1R8L
		Normally open, pneumatic spring return	574243	VUVG-B14-T32U-AZT-F-1R8L
		1x normally open, 1x normally closed, pneumatic spring return	574244	VUVG-B14-T32H-AZT-F-1R8L
		Normally closed, mechanical spring return	578248	VUVG-B14-T32C-MZT-F-1R8L
		Normally open, mechanical spring return	8031517	VUVG-B14-T32U-MZT-F-1R8L
		1x normally open, 1x normally closed, mechanical spring return	8031518	VUVG-B14-T32H-MZT-F-1R8L
	5/2-way valve, single solenoid			
	External pilot air supply	Pneumatic spring return	574245	VUVG-B14-M52-AZT-F-1R8L
		Mechanical spring return	578158	VUVG-B14-M52-MZT-F-1R8L
	5/2-way valve, double solenoid			
	External pilot air supply		574246	VUVG-B14-B52-ZT-F-1R8L
	5/3-way valve			
	External pilot air supply	Mid-position closed, mechanical spring return	574247	VUVG-B14-P53C-ZT-F-1R8L
Mid-position exhausted, mechanical spring return		574249	VUVG-B14-P53E-ZT-F-1R8L	
Mid-position pressurised, mechanical spring return		574248	VUVG-B14-P53U-ZT-F-1R8L	

Ordering data

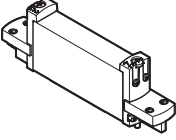
Ordering data	Description	Part no.	Type	
Sub-base valve G1/8, to ISO 15218				
	2x 3/2-way valve			
	External pilot air supply	Normally closed, pneumatic spring return	8033535	VUVG-B14-T32C-AZ-F-P1
		Normally open, pneumatic spring return	8033536	VUVG-B14-T32U-AZ-F-P1
		1x normally open, 1x normally closed, pneumatic spring return	8033537	VUVG-B14-T32H-AZ-F-P1
		Normally closed, mechanical spring return	8033538	VUVG-B14-T32C-MZ-F-P1
		Normally open, mechanical spring return	8033539	VUVG-B14-T32U-MZ-F-P1
		1x normally open, 1x normally closed, mechanical spring return	8033540	VUVG-B14-T32H-MZ-F-P1
	5/2-way valve, single solenoid			
	External pilot air supply	Pneumatic spring return	8033541	VUVG-B14-M52-AZ-F-P1
		Mechanical spring return	8033542	VUVG-B14-M52-MZ-F-P1
	5/2-way valve, double solenoid			
	External pilot air supply		8033543	VUVG-B14-B52-Z-F-P1
5/3-way valve				
External pilot air supply	Mid-position closed, mechanical spring return	8033544	VUVG-B14-P53C-Z-F-P1	
	Mid-position exhausted, mechanical spring return	8033545	VUVG-B14-P53E-Z-F-P1	
	Mid-position pressurised, mechanical spring return	8033546	VUVG-B14-P53U-Z-F-P1	

Manifold assembly

Sub-base valve for
Manifold assembly
Connection G1/8

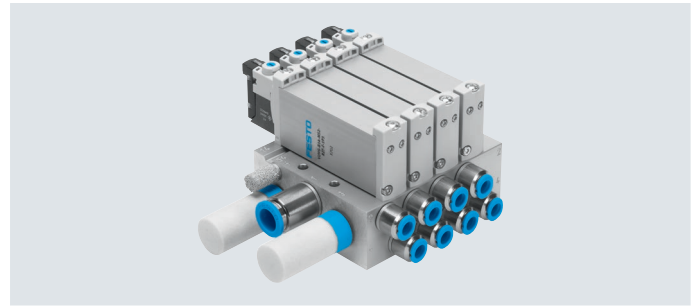

Dimensions

Download CAD data → www.festo.com

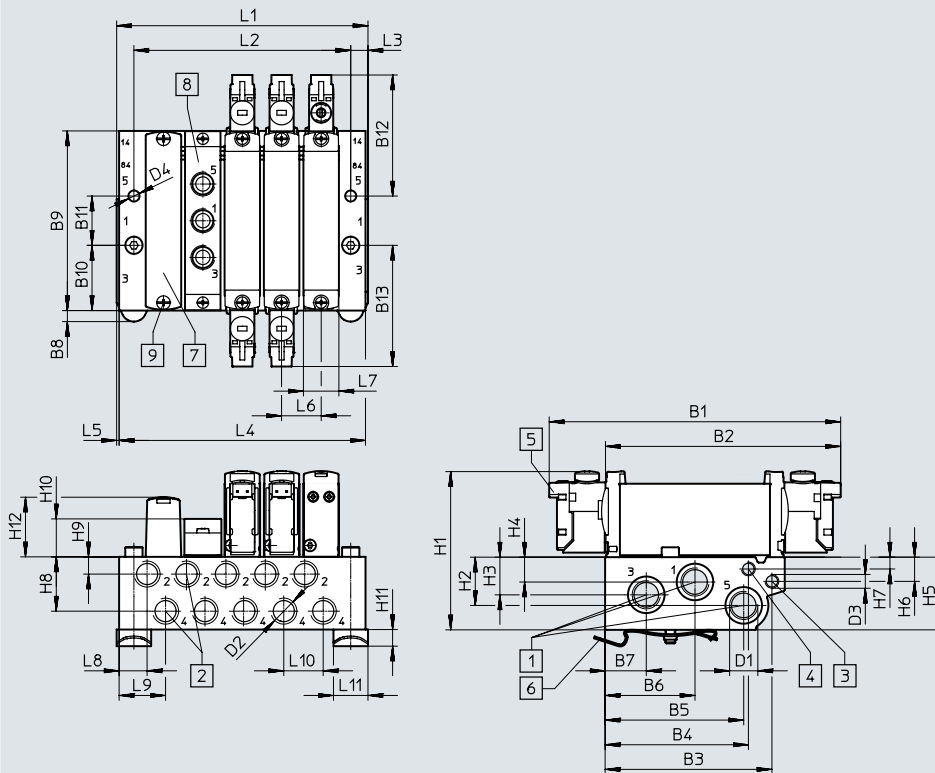

Note
More dimensions for
E-boxes
→ Page 113

- [1] Ports 1, 3 and 5: G1/4 (at both ends)
- [2] Ports 2, 4: G1/8
- [3] Ports 12, 14: M5
- [4] Ports 82, 84: M5
- [5] Electrical connection for E-boxes and accessories
- [6] H-rail mounting (two M4x35 screws are required for mounting)
- [7] Cover plate
- [8] Supply plate: ports 1, 3 and 5: G1/8
- [9] Valves/cover plate mounting on manifold rail: M2.5 thread

Type	B1	B2	B3	B4	B5	B6	B7	B8	B9	B10	B11	B12
VABM-L1-14W-G14	118.3	95.1	67.7	58.2	56.3	36.6	16.7	4.5	72.9	26.5	20	49.1

Type	B13	D1	D2	D3	D4	H1	H2	H3	H4	H5
VABM-L1-14W-G14	49.1	G1/4	G1/8	M5	∅ 4.5	64.3	19.6	15.3	10.1	29.5

Type	H6	H7	H8	H9	H10	H11	H12	L3	L5	L6	L7	L8	L9	L10	L11
VABM-L1-14W-G14	9.8	4.8	22.1	7	15.4	6.8	23.9	6	1	16	14.4	11.3	18.5	16	14

Valve positions	2	3	4	5	6	7	8	9	10	12	14	16
L1	56.3	72.3	88.3	104.3	120.3	136.3	152.3	168.3	184.3	216.3	248.3	280.3
L2	40	56	72	88	104	120	136	152	168	200	232	264
L4	54.3	70.3	86.3	102.3	118.3	134.3	150.3	166.3	182.3	214.3	246.6	278.3
VABM weight [g]	232	306	380	454	528	602	676	750	824	972	1120	1268

Ordering data

Technical data – Manifold rails¹⁾

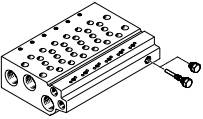
	Port			CRC	Material ³⁾	Operating pressure		Max. tightening torque for assembly [Nm]		
	2, 4	1, 3, 5	12/14, 82/84			[MPa]	[bar]	Valve	H-rail	Wall
	G1/8	G1/4	M5	2 ²⁾	Wrought aluminium alloy	-0.09 ... 1	-0.9 ... 10	0.65	1.5	3

1) Blanking plugs are included with the manifold rail.



2) More information www.festo.com/x/topic/crc

3) Information on materials: RoHS-compliant.

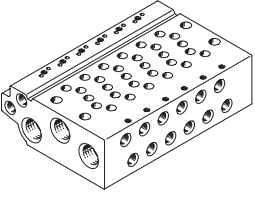
Ordering data – Manifold rail

	Description	Part no.	Type
Manifold rail for sub-base valve G1/8			
	For size B14 (G1/8)	2 valve positions	★ 566642 VABM-L1-14W-G14-2
		3 valve positions	★ 566643 VABM-L1-14W-G14-3
		4 valve positions	★ 566644 VABM-L1-14W-G14-4
		5 valve positions	566645 VABM-L1-14W-G14-5
		6 valve positions	★ 566646 VABM-L1-14W-G14-6
		7 valve positions	566647 VABM-L1-14W-G14-7
		8 valve positions	★ 566648 VABM-L1-14W-G14-8
		9 valve positions	566649 VABM-L1-14W-G14-9
		10 valve positions	★ 566650 VABM-L1-14W-G14-10
		12 valve positions	566651 VABM-L1-14W-G14-12
		14 valve positions	566652 VABM-L1-14W-G14-14
	16 valve positions	566653 VABM-L1-14W-G14-16	

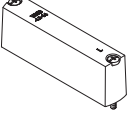
Ordering data – Accessories

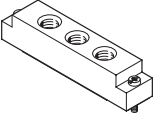
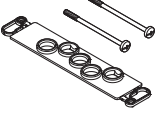



	Description	Part no.	Type
Cover plate Datasheets → Internet: vabb			
	For valve position on manifold rail, including screws and seal	–	★ 569989 VABB-L1-14
	Suitable for battery manufacturing	8168539	VABB-L1-14-F1A
Separator Datasheets → Internet: vabd			
	For creating pressure zones	569996	VABD-10-B
Supply plate Datasheets → Internet: vabf			
	For valve position on manifold rail, including screws and seal	–	569993 VABF-L1-14-P3A4-G18
	Suitable for battery manufacturing	8163544	VABF-L1-14-P3A4-G18-F1A
Seals Datasheets → Internet: vabd			
	For sub-base valves G1/8	Delivery quantity: 10 sets (each with 2 screws and 1 seal)	566676 VABD-L1-14B-S-G18

Datasheet

Function

2x 3/2C, 2x 3/2U, 2x 3/2H
 5/2-way, single solenoid
 5/2-way, double solenoid valve
 5/3C, 5/3U, 5/3E

Circuit diagrams → page 14

-  - Size 18 mm
-  - Flow rate
800 ... 1150 l/min
-  - Voltage
5, 12 and 24 V DC
-  - Voltage VUVG-...-P1
12 and 24 V DC
24, 110 and 230 V AC

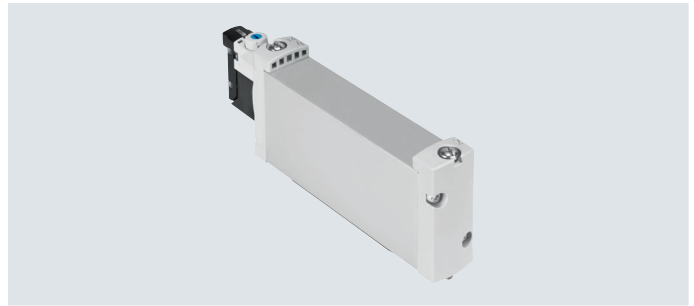

General technical data VUVG-B

Valve function	T32-A			T32-M			M52-R	B52	M52-M	P53			
Normal position	C ¹⁾	U ²⁾	H ⁴⁾	C ¹⁾	U ²⁾	H ⁴⁾	–	–	–	C ¹⁾	U ²⁾	E ³⁾	
Stable position	Monostable							Bistable	Monostable	Monostable			
Pneumatic spring return	Yes			No			Yes ⁵⁾	–	No	–			
Mechanical spring return	No			Yes			Yes ⁵⁾	–	Yes	Yes			
Vacuum operation at port 1	No			Only with external pilot air supply									
Design	Piston spool												
Sealing principle	Soft												
Actuation type	Electrical												
Type of control	Piloted												
Pilot air supply	External, internal; can be selected via sub-base												
Exhaust air function	Can be throttled												
Manual override	VUVG-...	Choice of non-detenting, covered, non-detenting/detenting or detenting											
	VUVG-...-P1	–											
Type of mounting	On manifold rail												
Mounting position	Any												
Nominal width	[mm]	5.7					6.9	7.3	6.9	6.5			
Standard nominal flow rate	[l/min]	900					1150			1080			
Flow rate on manifold rail		800					1000			950			
Switching time													
VUVG-...	On/off	[ms]	13/27			15/22		15/31	–	10/45		15/48	
	Changeover	[ms]	–									11	29
VUVG-...-P1	On/off	[ms]	13/18			13/27		16/22	–	14/26		15/32	
	Changeover	[ms]	–									12	21
Size	[mm]	18											
Port	1, 3, 5	G3/8 in manifold rail											
	2, 4	G1/4 in manifold rail											
	12/14, 82/84	M5 in manifold rail											
Product weight	VUVG-...	[g]	164					154	160	154	160		
	VUVG-...-P1	[g]	140					142	140	142	136		
Certificate-issuing authority	VUVG-...-P1	UL MH19482											
Certification	VUVG-...	RCM											
	VUVG-...	c UL us - Recognized (OL)											
	VUVG-...-P1												
CE marking (see declaration of conformity)⁶⁾													
	VUVG-...	To EU EMC Directive											
	VUVG-...-P1	To EU Low Voltage Directive											
Corrosion resistance class CRC ⁷⁾		2											

1) C=Normally closed/mid-position closed

2) U=Normally open/mid-position pressurised

3) E=Mid-position exhausted

4) H=2x 3/2-way valve in one housing with 1x normally closed and 1x normally open

5) Combined reset method

6) For information about the area of use, see the EC declaration of conformity at: www.festo.com/catalogue/... → Support/Downloads.

If the devices are subject to usage restrictions in residential, commercial or light-industrial environments, further measures for the reduction of the emitted interference may be necessary.

7) More information www.festo.com/x/topic/crc

Datasheet

Operating and environmental conditions			T32-A ¹⁾	T32-M ³⁾	M52-R ²⁾	B52	M52-M ³⁾	P53
Valve function			Compressed air to ISO 8573-2010 [7:4:4]					
Operating pressure	Internal	[MPa]	0.15 ... 0.8	0.3 ... 0.8	0.25 ... 0.8	0.15 ... 0.8	0.3 ... 0.8	
		[bar]	1.5 ... 8	3 ... 8	2.5 ... 8	1.5 ... 8	3 ... 8	
	External	[MPa]	0.15 ... 1	-0.09 ... 1			-0.09 ... 1	-0.09 ... 1
		[bar]	1.5 ... 10	-0.9 ... 10			-0.9 ... 10	-0.9 ... 10
Pilot pressure		[MPa]	0.15 ... 0.8	0.2 ... 0.8	0.25 ... 0.8	0.15 ... 0.8	0.3 ... 0.8	
		[bar]	1.5 ... 8	2 ... 8	2.5 ... 8	1.5 ... 8	3 ... 8	
Ambient temperature	VUVG-...	[°C]	-5 ... +50, with holding current reduction -5 ... +60					
	VUVG-...-P1	[°C]	-5 ... +60					
Temperature of medium	VUVG-...	[°C]	-5 ... +50, with holding current reduction -5 ... +60					
	VUVG-...-P1	[°C]	-5 ... +60					

- 1) Pneumatic spring
- 2) Combined pneumatic/mechanical spring
- 3) Mechanical spring

Electrical data			
Electrical connection	VUVG-...		Via E-box → page 111
	VUVG-...-P1		Via electric pilot valve
Pilot interface	VUVG-...-P1		To ISO 15218
Operating voltage	VUVG-...	[V DC]	5, 12 and 24 ±10%
		[V DC]	12 and 24 ±10%
		[V AC]	24, 110 and 230 ±10%
Power	VUVG-...	[W]	1, reduced to 0.35 with holding current reduction
	VUVG-...-P1	[W]	1.3
Duty cycle		[%]	100
Protection rating to EN 60529			
	VUVG-...		IP40 (with plug socket), IP65 (with M8)
	VUVG-...-P1		IP65, with electric pilot valve and plug socket

Information on materials	
Housing	Wrought aluminium alloy
Seals	HNBR, NBR
Note on materials	RoHS-compliant
LABS (PWIS) conformity	VDMA24364-B1/B2-L

Dimensions VUVG-B18-...F-...

Download CAD data → www.festo.com

2x 3/2-way, 5/2-way and 5/3-way valve

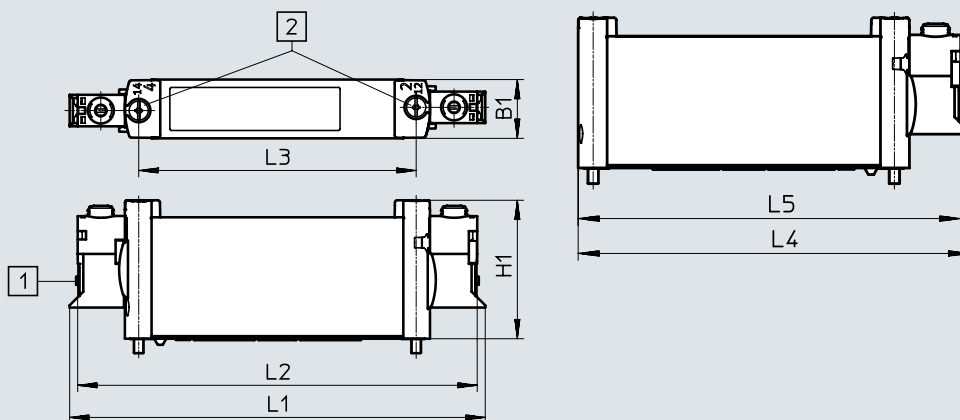

Note
 More dimensions for
 E-boxes
 → Page 113

- [1] Horizontal electrical connection
- [2] Manual override

Type	B1	H1	L1	L2	L3	L4	L5
VUVG-B18 -...-F-...	18.3	43.1	129.4	124.4	86.4	112.2	109.7

Datasheet

Dimensions VUVG-B18-...-F-P1Download CAD data → www.festo.com

2x 3/2-way, 5/2-way and 5/3-way valve

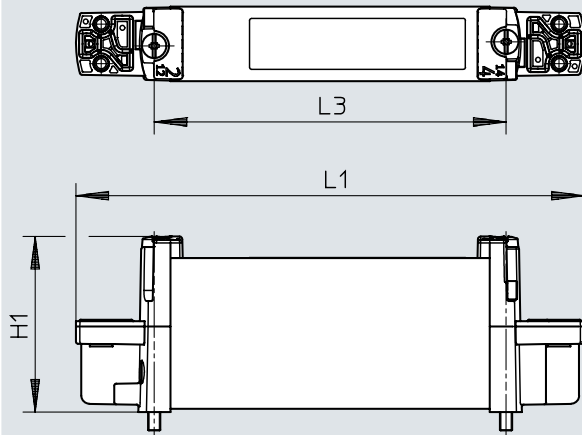

Type	H1	L1	L3
VUVG-B18-...-F-P1	43.1	124.8	86.4

Ordering data

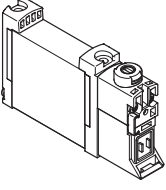
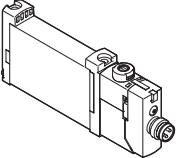
Ordering data	Description	Part no.	Type	
Sub-base valve G1/4, without E-box				
	2x 3/2-way valve			
	External pilot air supply	Normally closed, pneumatic spring return	574443	VUVG-B18-T32C-AZT-F-1P3
		Normally open, pneumatic spring return	574444	VUVG-B18-T32U-AZT-F-1P3
		1x normally open, 1x normally closed, pneumatic spring return	574445	VUVG-B18-T32H-AZT-F-1P3
		Normally closed, mechanical spring return	574446	VUVG-B18-T32C-MZT-F-1P3
		Normally open, mechanical spring return	574447	VUVG-B18-T32U-MZT-F-1P3
		1x normally open, 1x normally closed, mechanical spring return	574448	VUVG-B18-T32H-MZT-F-1P3
	5/2-way valve, single solenoid			
	External pilot air supply	Pneumatic/mechanical spring return	574449	VUVG-B18-M52-RZT-F-1P3
		Mechanical spring return	574450	VUVG-B18-M52-MZT-F-1P3
	5/2-way valve, double solenoid			
	External pilot air supply		574451	VUVG-B18-B52-ZT-F-1P3
	5/3-way valve			
External pilot air supply	Mid-position closed, mechanical spring return	574452	VUVG-B18-P53C-ZT-F-1P3	
	Mid-position exhausted, mechanical spring return	574453	VUVG-B18-P53E-ZT-F-1P3	
	Mid-position pressurised, mechanical spring return	574454	VUVG-B18-P53U-ZT-F-1P3	
Sub-base valve G1/4, with E-box R8				
	2x 3/2-way valve			
	External pilot air supply	Normally closed, pneumatic spring return	8031537	VUVG-B18-T32C-AZT-F-1R8L
		Normally open, pneumatic spring return	8031538	VUVG-B18-T32U-AZT-F-1R8L
		1x normally open, 1x normally closed, pneumatic spring return	8031539	VUVG-B18-T32H-AZT-F-1R8L
		Normally closed, mechanical spring return	8031540	VUVG-B18-T32C-MZT-F-1R8L
		Normally open, mechanical spring return	8031541	VUVG-B18-T32U-MZT-F-1R8L
		1x normally open, 1x normally closed, mechanical spring return	8031542	VUVG-B18-T32H-MZT-F-1R8L
	5/2-way valve, single solenoid			
	External pilot air supply	Pneumatic/mechanical spring return	8031543	VUVG-B18-M52-RZT-F-1R8L
		Mechanical spring return	8031544	VUVG-B18-M52-MZT-F-1R8L
	5/2-way valve, double solenoid			
	External pilot air supply		8031545	VUVG-B18-B52-ZT-F-1R8L
	5/3-way valve			
External pilot air supply	Mid-position closed, mechanical spring return	8031546	VUVG-B18-P53C-ZT-F-1R8L	
	Mid-position exhausted, mechanical spring return	8031547	VUVG-B18-P53E-ZT-F-1R8L	
	Mid-position pressurised, mechanical spring return	8031548	VUVG-B18-P53U-ZT-F-1R8L	

Ordering data

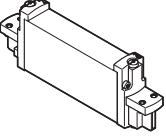
Ordering data	Description	Part no.	Type	
Sub-base valve G1/4, to ISO 15218				
	2x 3/2-way valve			
	External pilot air supply	Normally closed, mechanical spring return	8033559	VUVG-B18-T32C-AZ-F-P1
		Normally open, mechanical spring return	8033560	VUVG-B18-T32U-AZ-F-P1
		Normally open/closed, mechanical spring return	8033561	VUVG-B18-T32H-AZ-F-P1
		Normally closed, single solenoid, mechanical spring return	8033562	VUVG-B18-T32C-MZ-F-P1
		Normally open, single solenoid, mechanical spring return	8033563	VUVG-B18-T32U-MZ-F-P1
		Normally open/closed, single solenoid, mechanical spring return	8033564	VUVG-B18-T32H-MZ-F-P1
	5/2-way valve, single solenoid			
	External pilot air supply	Mechanical spring return	8033565	VUVG-B18-M52-RZ-F-P1
			8033566	VUVG-B18-M52-MZ-F-P1
	5/2-way valve, double solenoid			
	External pilot air supply		8033567	VUVG-B18-B52-Z-F-P1
	5/3-way valve			
	External pilot air supply	Normally closed, mechanical spring return	8033568	VUVG-B18-P53C-Z-F-P1
Mid-position exhausted, mechanical spring return		8033569	VUVG-B18-P53E-Z-F-P1	
Mid-position pressurised, mechanical spring return		8033570	VUVG-B18-P53U-Z-F-P1	

Manifold assembly

Sub-base valve for manifold assembly
Connection G1/4

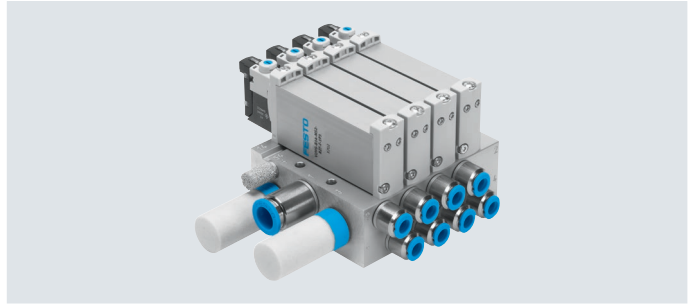

Dimensions

Download CAD data → www.festo.com

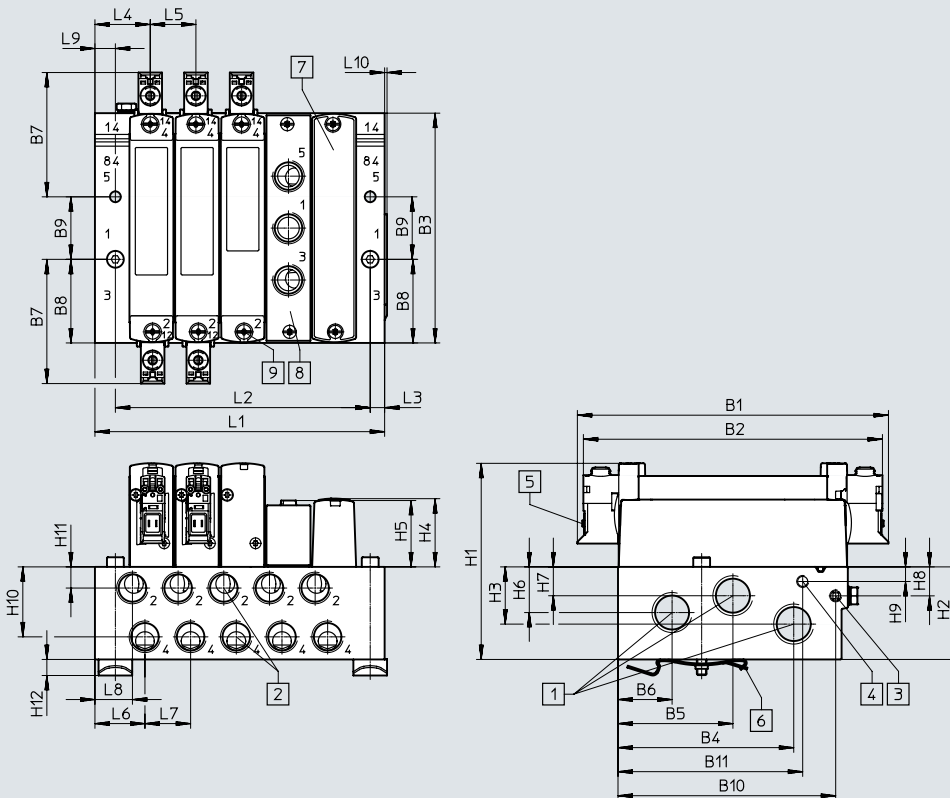

Note
More dimensions for E-boxes
→ Page 113

- [1] Ports 1, 3 and 5: G3/8 (at both ends)
- [2] Ports 2, 4: G1/4
- [3] Ports 12, 14: M5
- [4] Ports 82, 84: M5
- [5] Electrical connection for E-boxes and accessories
- [6] H-rail mounting (two M4x40 screws are required for mounting)
- [7] Cover plate
- [8] Supply plate, ports 1, 3 and 5: G1/4
- [9] Valve/cover plate/supply plate mounting on manifold rail: M3 thread

Type	B1	B2	B3	B4	B5	B6	B7	B8	B9	B10	B11	D1
VABM-L1-18W-G38	129.4	124.4	95.6	73.1	47.8	22.5	51.7	34.8	26	90.6	76.8	4.5

Type	H1	H2	H3	H4	H5	H6	H7	H8	H9	H10	H11	H12
VABM-L1-18W-G38	81.6	38.5	11.5	28.4	27.6	19	12	12.1	6.1	29.1	8.8	6.5

Type	L3	L4	L5	L6	L7	L8	L9	L10
VABM-L1-18W-G38	6	23	19	20.8	19	15.6	8.5	1

Valve positions	2	3	4	5	6	7	8	9	10	12	14	16
L1	63.5	82.5	101.5	120.5	139.5	158.5	177.5	196.5	215.5	253.5	291.5	329.5
L2	49	68	87	106	125	144	163	182	201	239	277	315
VABM weight [g]	232	306	380	454	528	602	676	750	824	972	1120	1268

Ordering data

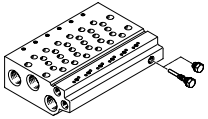
Technical data – Manifold rails ¹⁾	Port			CRC	Material ³⁾	Operating pressure		Max. tightening torque for assembly [Nm]		
	2, 4	1, 3, 5	12/14, 82/84			[MPa]	[bar]	Valve	H-rail	Wall
	G1/4	G3/8	M5	2 ²⁾	Wrought aluminium alloy	-0.09 ... 1	-0.9 ... 10	1.18	1.5	3



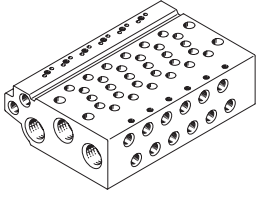

1) Blanking plugs are included with the manifold rail.

2) More information www.festo.com/x/topic/crc

3) Information on materials: RoHS-compliant.

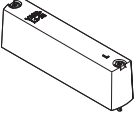
Ordering data – Manifold rails		Description	Part no.	Type	
Manifold rail for sub-base valve G1/4					
	For size B18 (G1/4)		2 valve positions	574467	VABM-L1-18W-G38-2
			3 valve positions	574468	VABM-L1-18W-G38-3
			4 valve positions	574469	VABM-L1-18W-G38-4
			5 valve positions	574470	VABM-L1-18W-G38-5
			6 valve positions	574471	VABM-L1-18W-G38-6
			7 valve positions	574472	VABM-L1-18W-G38-7
			8 valve positions	574473	VABM-L1-18W-G38-8
			9 valve positions	574474	VABM-L1-18W-G38-9
			10 valve positions	574475	VABM-L1-18W-G38-10
			12 valve positions	574476	VABM-L1-18W-G38-12
			14 valve positions	574477	VABM-L1-18W-G38-14
		16 valve positions	574478	VABM-L1-18W-G38-16	

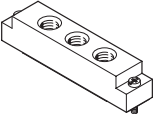
Ordering data

Ordering data – Accessories				
	Description	Part no.	Type	
Datasheets → Internet: vabb				
	For valve position on manifold rail, including screws and seal	★ 574482	VABB-L1-18	
Datasheets → Internet: vabd				
	For creating pressure zones	574483	VABD-14-B	
Datasheets → Internet: vabf				
	For valve position on manifold rail, including screws and seal	574481	VABF-L1-18-P3A4-G14	
Datasheets → Internet: vabd				
	For sub-base valves G1/4	Delivery quantity: 10 sets (each with 2 screws and 1 seal)	574480	VABD-L1-18B-S-G14

 **Note**

Connect supply plate at port 1 with compressed air. Reverse operation (pressure at port 3, 5) is not permissible.

E-boxes

General technical data		H2	H3	S2	S3	L-	R1	R8
Mounting position	Any							
Electrical connection	2-pin, socket					Flying leads	M8 individual plug, 4-pin	M8 individual plug, 3-pin
Degree of protection	IP40						IP65	
Signal status display	LED							
Type of mounting	Clip						Self-tapping screw	
Note on materials	RoHS-compliant							
Housing colour	Black							
Information on materials: housing	PA							
Certification	RCM							

Protective circuit without holding current reduction

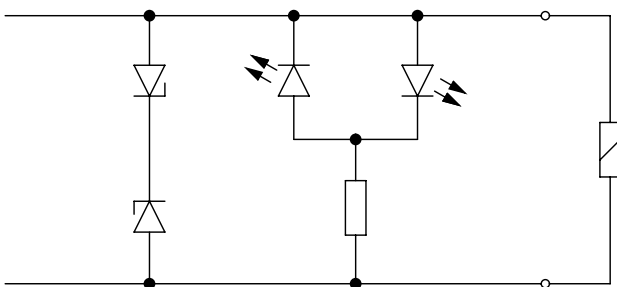

The solenoid coils (P-type) of the 5, 12 and 24 V designs have a protective circuit to arrest sparks and protect against polarity reversal.

Protective circuit with holding current reduction

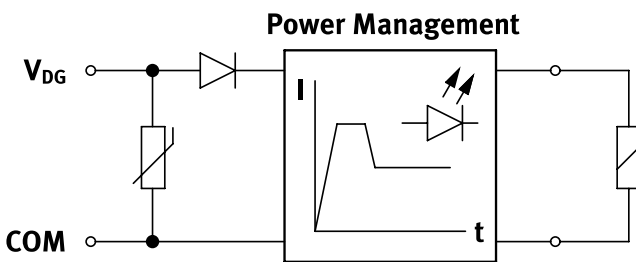



The 24 V DC design (R type) additionally features holding current reduction. This reduces the power from 1 W to 0.35 W.

Pin allocation for E-box

	Pin	Description
Rectangular plug, connection pattern H		
	VAVE-L1-1VH2-LP, VAVE-L1-1VH3-LP	
	1	+ or -
	2	+ or -
	VAVE-L1-1H2-LR, VAVE-L1-1H3-LR	
	1	+
	2	-
Rectangular plug, connection pattern S		
	VAVE-L1-1VS2-LP, VAVE-L1-1VS3-LP	
	1	+ or -
	2	+ or -
	VAVE-L1-1S2-LR, VAVE-L1-1S3-LR	
	1	-
	2	+
Stranded conductor, 2-pin		
	VAVE-L1-1VL1...4-LP	
	1	+ or -
	2	+ or -
	VAVE-L1-1L1...4-LR	
	1	-
	2	+

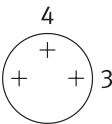
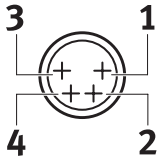
E-boxes

Pin allocation for E-box		Pin	Description
Round plug, M8, 3-pin			
	VAVE-L1-1VR8-LP		
	1	Not used	Without holding current reduction
	3	+ or -	
	4	+ or -	
	VAVE-L1-1R8-LR		
	1	Not used	With holding current reduction
3	+ or -		
4	+ or -		
Round plug, M8, 4-pin			
	VAVE-L1-1VR1-LP		
	1	Not used	Without holding current reduction
	2	Not used	
	3	+ or -	
	4	+ or -	
	VAVE-L1-1R1-LR		
	1	Not used	With holding current reduction
	2	Not used	
3	+ or -		
4	+ or -		
Open cable end			
	VAVE-L1-1VK...		
	BK	+ or -	Without holding current reduction
	BK	+ or -	
	VAVE-L1-1K...		
BK	+ or -	With holding current reduction	
BK	+ or -		

E-boxes

Dimensions

E-boxes, S2/H2

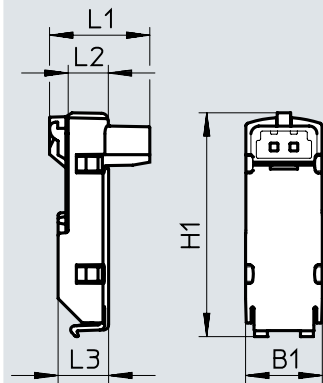

Type	B1	H1 ±0.5	L1	L2	L3
VAVE-L1-1VS2-LP	9.8	28.8	12.9	5.2	6.5
VAVE-L1-1S2-LR					
VAVE-L1-1VH2-LP			10.8		
VAVE-L1-H2-LR					

Download CAD data → www.festo.com

E-boxes, S3/H3

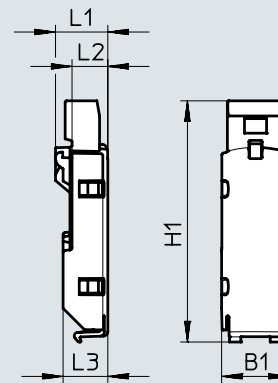

Type	B1	H1 ±0.5	L1	L2	L3
VAVE-L1-1VS3-LP	9.8	35	7.6	5.2	6.5
VAVE-L1-1S3-LR					
VAVE-L1-1VH3-LP		33.6	7.5		
VAVE-L1-1H3-LR					

Dimensions

E-boxes, VL11 ...1 4

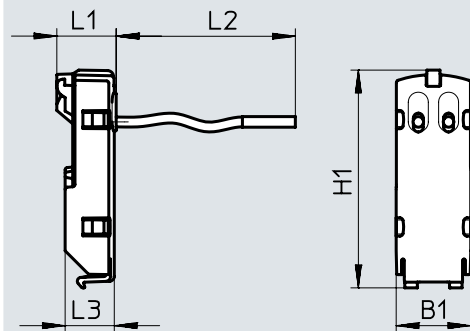

Type	B1	H1 ±0.5	L1	L2	L3
VAVE-L1-1VL1-LP	9.8	28.8	7.9	0.5	6.5
VAVE-L1-1L1-LR				1	
VAVE-L1-1VL2-LP					
VAVE-L1-1L2-LR				2.5	
VAVE-L1-1VL3-LP					
VAVE-L1-1L3-LR				5	
VAVE-L1-1VL4-LP					
VAVE-L1-1L4-LR					

Download CAD data → www.festo.com

E-boxes, VK6 ... 9

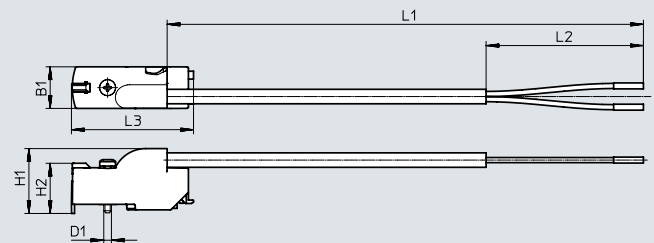

Type	B1	H1	H2 ±0.3	L1	L2 ±5	L3 ±0.5	D1 Ø
VAVE-L1-1VK6-LP	9.8	15.3	11.8	0.5	50	28.7	1.8
VAVE-L1-1VK7-LP				1.0			
VAVE-L1-1VK8-LP				2.5			
VAVE-L1-1VK9-LP				5.0			
VAVE-L1-1K6-LR				0.5			
VAVE-L1-1K7-LR				1.0			
VAVE-L1-1K8-LR				2.5			
VAVE-L1-1K9-LR				5.0			

E-boxes

Dimensions

Download CAD data → www.festo.com

E-boxes, R8/R1

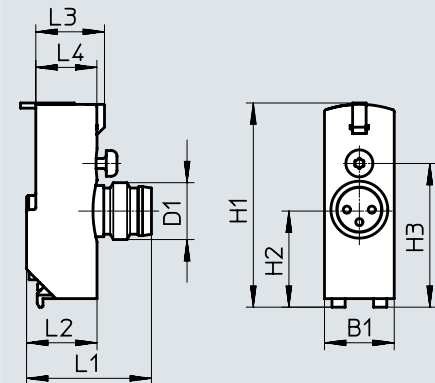









Type	B1	H1	H2	H3	L1	L2	L3	L4	D1 ø
VAVE-L1-1VR8-LP	9.8	28.7	13.7	20.2	18.4	9.9	9.7	8.6	M8
VAVE-L1-1VR1-LP									

Ordering data – E-boxes

Design	Plug	Additional functions	Ambient temperature [°C]	Code	Power [W]	Voltage [V DC]	Part no.	Type
	NEBV-H1 ...	Spark arresting, bipolar, IP40	-5 ... +50	H2	1	12/24	★ 566714	VAVE-L1-1VH2-LP
		Spark arresting, holding current reduction, IP40	-5 ... +60	H2R	0.35	24	★ 566716	VAVE-L1-1H2-LR
	NEBV-H1 ...	Spark arresting, bipolar, IP40	-5 ... +50	H3	1	12/24	566715	VAVE-L1-1VH3-LP
		Spark arresting, holding current reduction, IP40	-5 ... +60	H3R	0.35	24	566717	VAVE-L1-1H3-LR
	NEBV-HS ...	Spark arresting, bipolar, IP40	-5 ... +50	S2	1	12/24	566718	VAVE-L1-1VS2-LP
		Spark arresting, holding current reduction, IP40	-5 ... +60	S2R	0.35	24	566720	VAVE-L1-1S2-LR
	NEBV-HS ...	Spark arresting, bipolar, IP40	-5 ... +50	S3	1	12/24	566719	VAVE-L1-1VS3-LP
		Spark arresting, holding current reduction, IP40	-5 ... +60	S3R	0.35	24	566721	VAVE-L1-1S3-LR
	Open cable end	Spark arresting, bipolar, IP40	-5 ... +50	L1	1	12/24	566722	VAVE-L1-1VL1-LP
				L2			566723	VAVE-L1-1VL2-LP
				L3			566724	VAVE-L1-1VL3-LP
				L4			566725	VAVE-L1-1VL4-LP
		Spark arresting, holding current reduction, IP40	-5 ... +60	L1R	0.35	24	566726	VAVE-L1-1L1-LR
				L2R			566727	VAVE-L1-1L2-LR
				L3R			566728	VAVE-L1-1L3-LR
				L4R			566729	VAVE-L1-1L4-LR

E-boxes



Ordering data – E-boxes									
Design	Plug	Additional functions	Ambient temperature [°C]	Code	Power	Voltage	Cable length	Part no.	Type
					[W]	[V DC]	[m]		
	Open cable end	Spark arresting, bipolar, IP65	-5 ... +60	K6	1	12/24	0.5	573941	VAVE-L1-1VK6-LP
				K7			1	★ 573942	VAVE-L1-1VK7-LP
				K8			2.5	573943	VAVE-L1-1VK8-LP
				K9			5	573944	VAVE-L1-1VK9-LP
		Spark arresting, bipolar, holding current reduction, IP65	-5 ... +60	K6R	0.35	24	0.5	573945	VAVE-L1-1K6-LR
				K7R			1	573946	VAVE-L1-1K7-LR
				K8R			2.5	573947	VAVE-L1-1K8-LR
				K9R			5	573948	VAVE-L1-1K9-LR
	NEBU-M8 ...	Spark arresting, bipolar, IP65	-5 ... +60	R8	1	12/24	-	★ 573919	VAVE-L1-1VR8-LP
		Spark arresting, bipolar, holding current reduction, IP65		R8R	0.35	24	-	573920	VAVE-L1-1R8-LR
		Spark arresting, bipolar, IP65		R1	1	12/24	-	573921	VAVE-L1-1VR1-LP
		Spark arresting, bipolar, holding current reduction, IP65		R1R	0.35	24	-	573922	VAVE-L1-1R1-LR

Ordering data – Pilot controls							
Design	Electrical connection	Manual override	Ambient temperature [°C]	Voltage		Part no.	Type
				[V DC]	[V AC]		
	Type C to DIN EN 175301-803	Non-detenting	-5 ... +50	24	-	8040564	VSCS-B-M32-MH-WA-1C1-8
				12	-	8040565	VSCS-B-M32-MH-WA-5C1-8
				-	24	8040566	VSCS-B-M32-MH-WA-1AC1-8
				-	110	8040567	VSCS-B-M32-MH-WA-2AC1-8
				-	230	8040568	VSCS-B-M32-MH-WA-3AC1-8
	Type C to industry standard			24	-	8137327	VSCS-B-M32-MH-WA-1E1-8
	M12 to IEC 61076-2-101			24	-	8040569	VSCS-B-M32-MH-WA-1R3-8
	Type C to DIN EN 175301-803	Non-detenting/detenting		24	-	8040570	VSCS-B-M32-MD-WA-1C1-8
				12	-	8040571	VSCS-B-M32-MD-WA-5C1-8
				-	24	8040572	VSCS-B-M32-MD-WA-1AC1-8
				-	110	8040573	VSCS-B-M32-MD-WA-2AC1-8
				-	230	8040574	VSCS-B-M32-MD-WA-3AC1-8
	Type C to industry standard			24	-	8137328	VSCS-B-M32-MD-WA-1E1-8
	M12 to IEC 61076-2-101			24	-	8040575	VSCS-B-M32-MD-WA-1R3-8

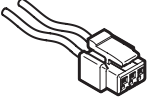
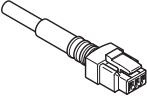
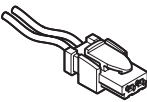
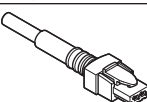
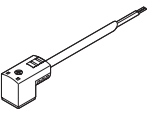
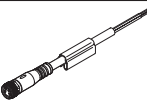
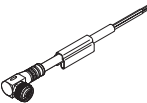
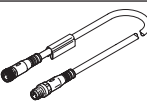
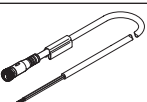
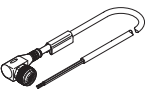
Accessories





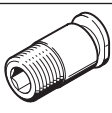

Ordering data		Cable length [m]	Part no.	Type
Plug socket with cable, not sheathed, open end		Datasheets → Internet: nebv		
	For E-box code H2, H2R or H3, H3R, 2-pin socket	0.5	★ 566654	NEBV-H1G2-KN-0.5-N-LE2
		1	★ 566655	NEBV-H1G2-KN-1-N-LE2
		2.5	★ 566656	NEBV-H1G2-KN-2.5-N-LE2
		5	566657	NEBV-H1G2-KN-5-N-LE2
Plug socket with cable, sheathed, open end		Datasheets → Internet: nebv		
	For E-box code H2, H2R or H3, H3R, 2-pin socket	0.5	★ 566658	NEBV-H1G2-P-0.5-N-LE2
		1	★ 566659	NEBV-H1G2-P-1-N-LE2
		2.5	★ 566660	NEBV-H1G2-P-2.5-N-LE2
		5	566661	NEBV-H1G2-P-5-N-LE2
Plug socket with cable, not sheathed, open end		Datasheets → Internet: nebv		
	For E-box code S2, S2R or S3, S3R, 2-pin socket,	0.5	566662	NEBV-HSG2-KN-0.5-N-LE2
		1	566663	NEBV-HSG2-KN-1-N-LE2
		2.5	566664	NEBV-HSG2-KN-2.5-N-LE2
		5	566665	NEBV-HSG2-KN-5-N-LE2
Plug socket with cable, sheathed, open end		Datasheets → Internet: nebv		
	For E-box code S2, S2R or S3, S3R, 2-pin socket	0.5	566666	NEBV-HSG2-P-0.5-N-LE2
		1	566667	NEBV-HSG2-P-1-N-LE2
		2.5	566668	NEBV-HSG2-P-2.5-N-LE2
		5	566669	NEBV-HSG2-P-5-N-LE2
Connecting cable, open end		Datasheets → Internet: neba		
	For pilot valve VSCS to ISO 15218, narrow socket, type C to EN 175301-803	2.5	8032623	NEBV-C1SW2L-P-K-2.5-N-LE2-S9
		5	8032626	NEBV-C1SW2L-P-K-5-N-LE2-S9
		10	8032627	NEBV-C1SW2L-P-K-10-N-LE2-S9
		2.5	8032628	NEBV-C1SW3-K-2.5-N-LE3-S9
		5	8032629	NEBV-C1SW3-K-5-N-LE3-S9
Connecting cable, open end		Datasheets → Internet: neba		
	For E-box code R8 3-pin, straight socket, M8x1	2.5	8078223	NEBA-M8G3-U-2.5-N-LE3
		5	8078224	NEBA-M8G3-U-5-N-LE3
	For E-box code R1 4-pin, straight socket, M8x1	2.5	8078227	NEBA-M8G4-U-2.5-N-LE4
		5	8078228	NEBA-M8G4-U-5-N-LE4
Connecting cable, open end		Datasheets → Internet: neba		
	For E-box code R8 3-pin, angled socket, M8x1	2.5	8078230	NEBA-M8W3-U-2.5-N-LE3
		5	8078231	NEBA-M8W3-U-5-N-LE3
	For E-box code R1 4-pin, angled socket, M8x1	2.5	8078233	NEBA-M8W4-U-2.5-N-LE4
		5	8078234	NEBA-M8W4-U-5-N-LE4
Connecting cable		Datasheets → Internet: nebu		
	For E-box code R8, 3-pin, straight socket, M8x1	0.5	★ 541346	NEBU-M8G3-K-0.5-M8G3
		1	★ 541347	NEBU-M8G3-K-1-M8G3
		2.5	★ 541348	NEBU-M8G3-K-2.5-M8G3
		5	★ 541349	NEBU-M8G3-K-5-M8G3
		10	569844	NEBU-M8G3-K-10-M8G3
	For E-box code R1, 4-pin, straight socket, M8x1	2.5	554035	NEBU-M8G4-K-2.5-M8G4
Connecting cable, open end		Datasheets → Internet: neba		
	For pilot valve VSCS to ISO 15218, straight socket, M12x1, A-coded to EN 61076-2-101	2.5	8078236	NEBA-M12G5-U-2.5-N-LE3
		5	8078237	NEBA-M12G5-U-5-N-LE3
	For pilot valve VSCS to ISO 15218, angled socket, M12x1, A-coded to EN 61076-2-101	2.5	8078245	NEBA-M12W5-U-2.5-N-LE3
		5	8078246	NEBA-M12W5-U-5-N-LE3

Accessories

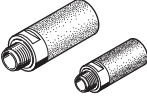
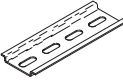
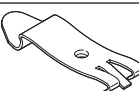
Ordering data		Description	Part no.	Type	PU ¹⁾	
Blanking plug		Datasheets → Internet: b				
	For manifold rail and valve	M5 thread	★ 3843	B-M5	10	
		M7 thread	★ 174309	B-M7	10	
	For manifold rail	Thread G1/8	★ 3568	B-1/8	10	
		G1/4 thread	★ 3569	B-1/4	10	
	For valve	G3/8 thread	★ 3570	B-3/8	10	
		Thread G1/8	578406	NPQH-BK-G18-P10	10	
		G1/4 thread	578407	NPQH-BK-G14-P10	10	
Reducing nipple						
	Male thread M7	Female thread M5	161359	D-M5I-M7A-ISK	10	
Fittings		Datasheets → Internet: sqm				
	M3 thread	For tubing Ø 3 mm	Round releasing ring	133001	QSM-M3-3-I-R	10
		For tubing Ø 4 mm	Round releasing ring	133002	QSM-M3-4-I-R	10
	M5 thread	For tubing Ø 3 mm	Round releasing ring	133003	QSM-M5-3-I-R	10
			Oval releasing ring	153313	QSM-M5-3-I	10
		For tubing Ø 4 mm	Round releasing ring	133004	QSM-M5-4-I-R	10
			Oval releasing ring	★ 153315	QSM-M5-4-I	10
	For tubing Ø 6 mm	Round releasing ring	133005	QSM-M5-6-I-R	10	
		Oval releasing ring	★ 153317	QSM-M5-6-I	10	
	M7 thread	For tubing Ø 4 mm	Oval releasing ring	★ 153319	QSM-M7-4-I	10
		For tubing Ø 6 mm	Round releasing ring	133007	QSM-M7-6-I-R	10
			Oval releasing ring	★ 153321	QSM-M7-6-I	10
	G1/8 thread	For tubing Ø 4 mm	Oval releasing ring	★ 186106	QS-G1/8-4-I	10
		For tubing Ø 6 mm	Oval releasing ring	★ 186107	QS-G1/8-6-I	10
		For tubing Ø 8 mm	Oval releasing ring	★ 186109	QS-G1/8-8-I	10
		For tubing Ø 10 mm	Oval releasing ring	★ 132999	QS-G1/8-10-I	10
	G1/4 thread	For tubing Ø 6 mm	Oval releasing ring	★ 186108	QS-G1/4-6-I	10
				130677	QS-1/4-6-100	100
		For tubing Ø 8 mm	Oval releasing ring	★ 186110	QS-G1/4-8-I	10
				★ 153016	QS-1/4-8-I	10
		For tubing Ø 10 mm	Oval releasing ring	★ 186112	QS-G1/4-10-I	10
			★ 153018	QS-1/4-10-I	10	
3/8 thread	For tubing Ø 8 mm	Oval releasing ring	130681	QS-3/8-8-50	50	
	For tubing Ø 10 mm	Oval releasing ring	130682	QS-3/8-10-50	50	
	For tubing Ø 12 mm	Oval releasing ring	130683	QS-3/8-12-20	20	
	For tubing Ø 16 mm	Oval releasing ring	164957	QS-3/8-16	1	





1) Packaging unit.

Accessories

Ordering data				Part no.	Type	PU ¹⁾
Silencer				Datasheets → Internet: amte		
	For M3 thread		1231120	AMTE-M-LH-M3	20	
	For M5 thread		★ 1205858	AMTE-M-LH-M5	20	
	For M7 thread		161418	UC-M7	1	
	For G1/8 thread	High flow rate	★ 2307	U-1/8	1	
		Lower flow rate	161419	UC-1/8	1	
	For G1/4 thread	High flow rate	★ 2316	U-1/4	1	
		Lower flow rate	165004	UC-1/4	1	
	For G3/8 thread	High flow rate	★ 2309	U-3/8	1	
		Lower flow rate	1707427	UC-3/8	1	
Metal housing		★ 6843	U-3/8-B	1		
H-rail				Datasheets → Internet: nrh		
	To EN 60715, 35 x 7.5 (WxH)	Length: 2 m	35430	NRH-35-2000	1	
H-rail mounting				Datasheets → Internet: vame		
	-		★ 569998	VAME-T-M4	2	
Cover cap for manual override						
	Covered		540898	VMPA-HBV-B	10	
	Non-detenting		540897	VMPA-HBT-B	10	
	Detenting (without accessories)		8002234	VAMC-L1-CD	10	
Identification holder				Datasheets → Internet: aslr		
	Holder for an inscription label and covering for the retaining screw and manual override		570818	ASLR-D-L1	10	
Mounting kit				Datasheets → Internet: davm		
	With mounting bracket for lateral valve mounting	For standards-based cylinder DSBC-32...40	For VUVG-L14	2568514	DAVM-MW-V1-32-V	1
		For standards-based cylinder DSBC-50...125	For VUVG-L18	2612128	DAVM-MW-V1-50-V	1

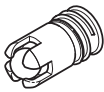
1) Packaging unit.

Accessories

Ordering data		Description	Part no.	Type	PU ¹⁾	
Check valve						
	For manifold rails VABM-L1-10...	For blocking the flow in the event of back pressure in duct 3 and 5	8047364	VABF-L1-10H-H2	10	
	For manifold rails VABM-L1-14...		8047365	VABF-L1-14-H2	10	
Flow restrictor						
	For manifold rails VABM-L1-10...	For setting the flow rate during pressurisation and exhausting (for M5 threaded connection)	Nominal width: 0.5 mm	8025709	VFFG-T-M5-5	10
			Nominal width: 0.6 mm	8025710	VFFG-T-M5-6	10
			Nominal width: 0.7 mm	8025711	VFFG-T-M5-7	10
			Nominal width: 0.85 mm	8025712	VFFG-T-M5-8	10
			Nominal width: 1.05 mm	8025713	VFFG-T-M5-10	10
			Nominal width: 1.2 mm	8025714	VFFG-T-M5-12	10
			Nominal width: 1.55 mm	8025715	VFFG-T-M5-15	10
		For setting the flow rate for pressurisation and exhausting (for ø 4 mm)	Nominal width: 0.5 mm	8047346	VFFG-T-F4-5	10
			Nominal width: 0.6 mm	8047347	VFFG-T-F4-6	10
			Nominal width: 0.7 mm	8047348	VFFG-T-F4-7	10
			Nominal width: 0.85 mm	8047349	VFFG-T-F4-8	10
			Nominal width: 1.05 mm	8047350	VFFG-T-F4-10	10
			Nominal width: 1.2 mm	8047351	VFFG-T-F4-12	10
	For manifold rails VABM-L1-14...	For setting the flow rate for pressurisation and exhausting (for ø 5.8 mm)	Nominal width: 1.55 mm	8047352	VFFG-T-F4-15	10
			Nominal width: 0.7 mm	8047353	VFFG-T-F6-7	10
			Nominal width: 0.85 mm	8047354	VFFG-T-F6-8	10
			Nominal width: 1.05 mm	8047355	VFFG-T-F6-10	10
			Nominal width: 1.15 mm	8047356	VFFG-T-F6-11	10
			Nominal width: 1.4 mm	8047357	VFFG-T-F6-14	10
			Nominal width: 1.6 mm	8047358	VFFG-T-F6-16	10
Nominal width: 1.8 mm	8047359	VFFG-T-F6-18	10			
Flow restrictor set						
	For manifold rails VABM-L1-10...	Two of each size, for M5 threaded connection	8025716	VFFG-T-M5-A-V1	14	
		Two of each size, for ø 4 mm	8062200	VFFG-T-F4-A-V1	14	
	For manifold rails VABM-L1-14...	Two of each size, for ø 5.8 mm	8062201	VFFG-T-F6-A-V1	14	

1) Packaging unit.