

## Valve terminal VTOP

**FESTO**

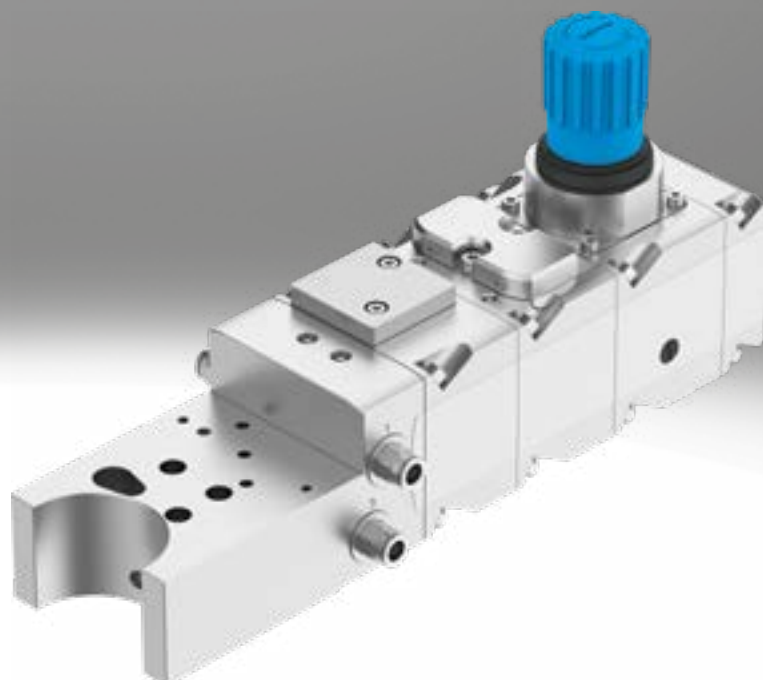

## Key features

### Function and use

The valve terminal VTOP can be used to implement additional pneumatic functions in combination with a positioner. It has a modular design and, depending on the modules used, the following additional pneumatic functions can be implemented:

- Compressed air regulation and filtering
- Volume flow boost
- Reaching a defined end position in the event of a pressure failure
- Safe exhausting

- Reversing the effective direction for double-acting pneumatic actuators
- The valve terminal VTOP, the pneumatic actuator and the positioner are mechanically and pneumatically connected by an adapter plate. The compressed air supply is connected centrally to the pneumatic ports of the adapter plate.
- The patented, integrated air duct supplies all modules, actuator and positioner. This eliminates the need for complex tubing or piping for the

individual modules. The simple, secure installation prevents errors and avoids leaks as there are fewer joints between the individual components. The valve terminal VTOP is suitable for the attachment of a positioner with VDE/VDI 3847-2 interface for the quarter turn actuator DFPD-...-C-VDE2 and linear actuators DFPI-...-E-NB3VM12. The available modules can be freely combined and are easy to extend and retrofit.

### Versatile

- Can be individually adapted for specific requirements
- Modules can be freely combined with one another
- Can be extended and retrofitted at any time
- Standardised mounting interface for direct attachment of a positioner in accordance with VDI/VDE 3847-2
- Suitable for quarter turn actuators DFPD-...-C-VDE2 and linear actuators DFPI-...-E-NB3VM12

### Easy to install

- Simple and secure installation: the integrated air duct avoids leaks as there are fewer joints between the individual components
- On-site maintenance and replacement possible to ensure utmost reliability and availability

### User-friendly

- No complex search for components and time-consuming installation
- The complete solution for automation is supplied from a single source, from the actuator to the positioner and the pneumatic extension modules VTOP

### Reliable

- More robust and compact than conventional solutions with external piping
- Different safety architectures can be implemented for HFT 0 or HFT 1 for safe exhausting

### Ordering data – Product options

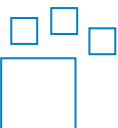

Configurable product  
This product and all its product options can be ordered using the configurator.

The configurator can be found at  
→ [www.festo.com/catalogue/...](http://www.festo.com/catalogue/...)  
Enter the part number or the type.

Part no.	Type
8141655	VTOP

## Product range overview

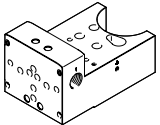
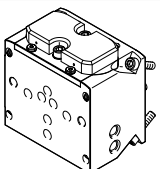
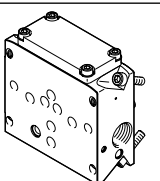
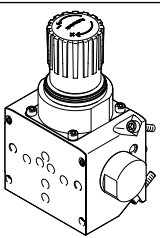
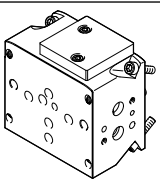
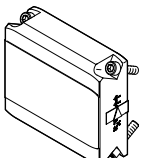
Function	Type code	Description	→ Page
	VABA	For the interface between valve terminal VTOP, pneumatic actuator and positioner. The compressed air supply of the VTOP is connected centrally to the pneumatic ports of the adapter plate. Various adapter plates are available, depending on the pneumatic actuator.	15
	VOGM	Modules for boosting the compressed air flow rate specified by the positioner. The volume booster is used if the process valve's response times have to be reduced. The direct integration of the volume booster in the control loop means that the pneumatic actuator can be precisely positioned even with fast response times.	15
	VOGI	Fail safe modules for travelling to a defined end position in case the compressed air fails. In the event of a failure at the pneumatic port of the adapter plate VABA, the module automatically depressurises duct 2, and duct 4 is supplied with compressed air via the redundant pneumatic supply air port (1) on the module. The defined end position depends on the orientation of the reversing plate in the end plate.	15
	PCRI	Modules for filtering and regulating the compressed air that passes through. The module smoothes out pressure fluctuations and regulates the compressed air to the set output pressure. The integrated filter removes dirt particles from the compressed air. The filter can be replaced if contaminated. A pressure gauge can be mounted as an accessory to display the set output pressure. The set output pressure can be secured against unauthorised adjustment by a regulator lock. The regulator lock is available as an accessory.	16
	VABP	Flange module for safe exhausting in different safety architectures for single-acting actuators. The module is used as an interface for mounting a solenoid valve in accordance with VDI/VDE 3847 for safe exhausting of the actuator. Up to 2 solenoid valves can be fitted. By using solenoid valves it is possible to implement safety functions with various safety architectures (HFT 0, HFT 1) for safe exhausting. Exhaust duct 2 of the mounted solenoid valve is always directly connected to duct 2, independently of other modules and module positions of the valve terminal VTOP.	16
	VABE	For sealing the valve terminal VTOP. The integrated reversing plate means that the effective direction can be reversed with double-acting pneumatic actuators.	16

## Key features

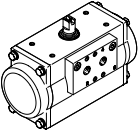
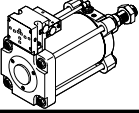
Supported combinations of valve terminal VTOP and process actuators			
Actuator		Size/piston diameter	Part no. Type
	Quarter turn actuators	240	8042190 DFPD-240-...-VDE2
		300	8042191 DFPD-300-...-VDE2
		480	8042192 DFPD-480-...-VDE2
		700	8042193 DFPD-700-...-VDE2
		900	8042194 DFPD-900-...-VDE2
		1200	8042195 DFPD-1200-...-VDE2
		2300	8042196 DFPD-2300-...-VDE2
		240	8102849 DFPD-240-RP-90-RS45-F10-R3-C-VDE2
		240	8102850 DFPD-240-RP-90-RS60-F10-R3-C-VDE2
		300	8102858 DFPD-300-RP-90-RS45-F10-R3-C-VDE2
		300	8102859 DFPD-300-RP-90-RS60-F10-R3-C-VDE2
		480	8102867 DFPD-480-RP-90-RS45-F12-R3-C-VDE2
		480	8102868 DFPD-480-RP-90-RS60-F12-R3-C-VDE2
		700	8102886 DFPD-700-RP-90-RS45-F12-R3-C-VDE2
		700	8102887 DFPD-700-RP-90-RS60-F12-R3-C-VDE2
		900	8102895 DFPD-900-RP-90-RS45-F14-R3-C-VDE2
		900	8102896 DFPD-900-RP-90-RS60-F14-R3-C-VDE2
		1200	8102904 DFPD-1200-RP-90-RS45-F14-R3-C-VDE2
		1200	8102905 DFPD-1200-RP-90-RS60-F14-R3-C-VDE2
		2300	8102912 DFPD-2300-RP-90-RS45-F16-R3-C-VDE2
2300	8102913 DFPD-2300-RP-90-RS60-F16-R3-C-VDE2		
	Linear actuators	160 mm	5091793 DFPI-160-...-E-NB3VM12
		200 mm	5092508 DFPI-200-...-E-NB3VM12
		250 mm	5099770 DFPI-250-...-E-NB3VM12
		320 mm	5106115 DFPI-320-...-E-NB3VM12

 **Note**

The valve terminal VTOP is not suitable for quarter turn actuators DFPD with feature "Spring force for connection pressure 3.5 bar"

## Type codes

001	Series
<b>VTOP</b>	Valve terminal
002	Size
<b>100</b>	100 mm
003	Compressed air supply connection
<b>F90</b>	Flange, nominal width 9 mm
004	Compressed air supply connection position
<b>L</b>	Left

005	Position function
<b>EP1</b>	End plate, double-acting, active direction can be switched
<b>FS1</b>	Module for reaching a specific end position in case of a pressure failure
<b>PC1</b>	Filter regulator, pressure range 0.5 ... 12 bar, grade of filtration 5 µm
<b>PC2</b>	Filter regulator, pressure range 0.5 ... 12 bar, grade of filtration 40 µm
<b>TB3</b>	Manifold block for safety functions, HFT0 prepared for exhaust, VDI/VDE 3845 extended
<b>TB4</b>	Manifold block for safety functions, HFT1 prepared for exhaust, VDI/VDE 3845 extended
<b>VB1</b>	Volume booster, single-acting
<b>VB2</b>	Volume booster, double-acting

Peripherals overview with quarter turn actuator

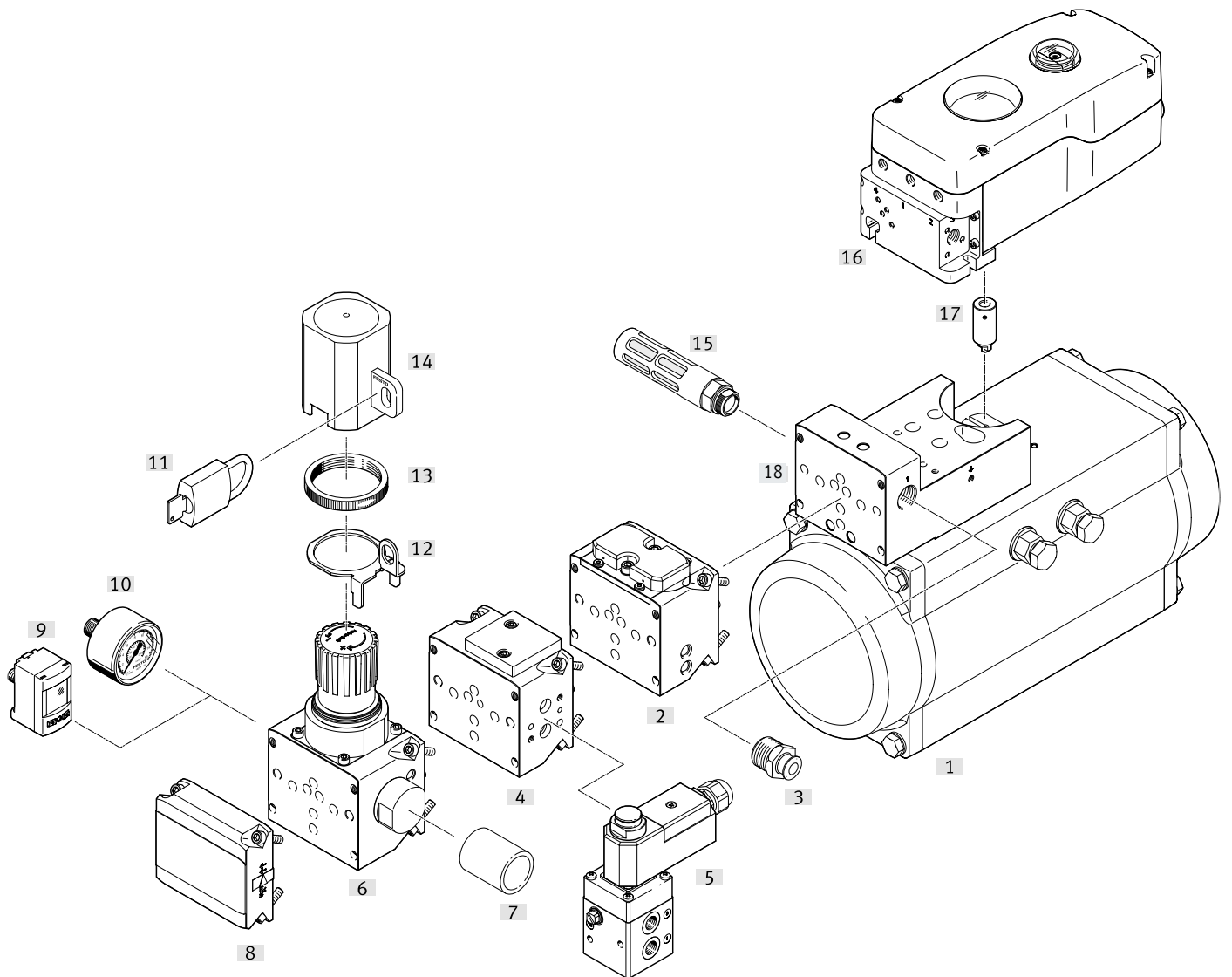

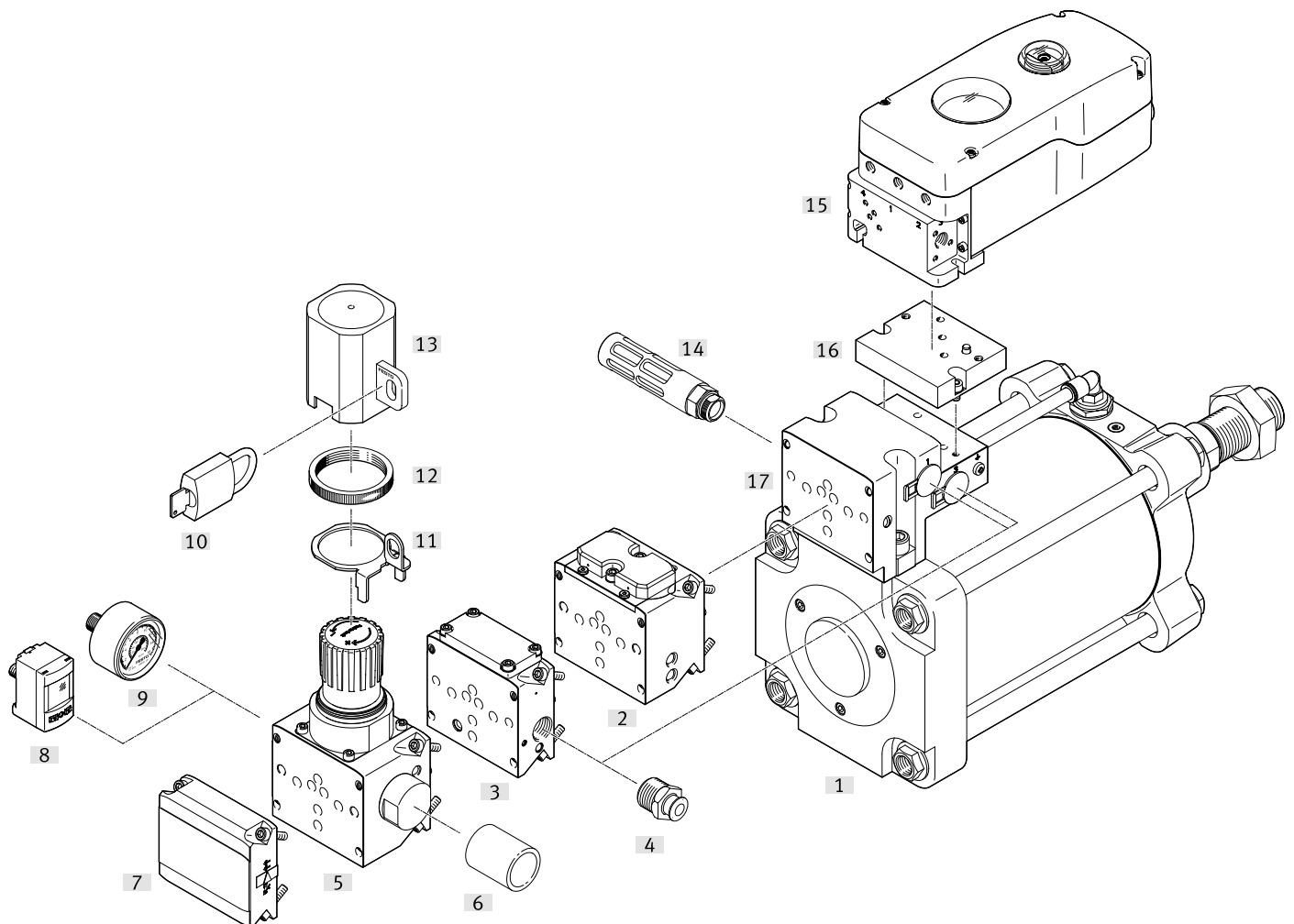

Accessories		
Type/order code	Description	→ Page/Internet
[1] Quarter turn actuator DFPD-...-C-VDE2	In sizes 240 ... 2300 → page 4	dfpd
[2] Pneumatic valve VOGM-FD100-...33...-M-F90	Modules for boosting the compressed air flow rate specified by the positioner	15
[3] Push-in fitting QS	For connecting tubing with standard O.D.	19
[4] Sub-base VABP-C13-100...-F90-VDE1E	<ul style="list-style-type: none"> <li>Flange module for safety functions</li> <li>Modules with interface for safe exhausting</li> </ul>	16
[5] Valve VOFC	Solenoid valve with internal pilot air and flanged connection G1/4	19
[6] Filter regulator PCRI-100-F90-12-...-T3	Module for filtering and regulating the compressed air	16
[7] Filter cartridge LFP	Metal design	18
[8] End plate VABE-C13-100-F90-DU	For sealing the valve terminal VTOP	16
[9] Pressure sensor SPAU	For direct mounting	18
[10] Pressure gauge MA	Pressure gauge with pneumatic connection G1/4	18
[11] Padlock LRVS-D	Padlock for regulator lock	18
[12] Regulator lock LRVS	Lock to prevent unauthorised adjustment of the set pressure of pressure and filter regulators	18
[13]		
[14]		
[15] Silencer	For noise reduction and avoiding contamination at the exhaust ports	19
[16] Positioner CMSH-S-VDE2-...	Intelligent, digital positioner with HART communication	cmsh
[17] Coupling CAFM-M1-CK-N3	For connecting the shaft of positioners with the interface according to VDI/VDE 3847-2 and quarter turn actuator	18
[18] Adapter plate VABA-C13-100-...-F90-G12	Adapter plate between valve terminal VTOP, pneumatic actuator and positioner	15

## Peripherals overview with linear actuator



Accessories			
Type/order code	Description		→ Page/Internet
[1] Linear actuator DFPI-...-ND2P-E-NB3VM12	In piston diameters 160 ... 320 mm → page 4		dfpi
[2] Pneumatic valve VOGM-FD100-...33...-M-F90	Modules for boosting the compressed air flow rate specified by the positioner		15
[3] Pneumatic valve VOGI-F100FS-T32H-M-F90	<ul style="list-style-type: none"> <li>Flange module for safety functions</li> <li>Modules with interface for safe exhausting</li> </ul>		16
[4] Push-in fitting QS	For connecting tubing with standard O.D.		19
[5] Filter regulator PCRI-100-F90-12-...-T3	Module for filtering and regulating the compressed air		16
[6] Filter cartridge LFP	Metal design		18
[7] End plate VABE-C13-100-F90-DU	End plate for reversing the effective direction		16
[8] Pressure sensor SPAU	For direct mounting		19
[9] Pressure gauge MA	Pressure gauge with pneumatic connection G1/4		18
[10] Padlock LRVS-D	Padlock for regulator lock		18
[11] Regulator lock LRVS	Lock to prevent unauthorised adjustment of the set pressure of pressure and filter regulators		18
[12]			
[13]			
[14] Silencer	For noise reduction and avoiding contamination at the exhaust ports		19
[15] Positioner CMSH-S-VDE2-...	Intelligent, digital positioner with HART communication		cmsh
[16] Adapter kit DADG-AK-F9-2	For mounting VTOP on quarter turn actuator CMSH-2300-...-VDE2		18
[17] Adapter plate VABA-C13-100-...-F90-G12	Adapter plate between valve terminal VTOP, pneumatic actuator and positioner		15

Datasheet

-  - Operating pressure  
0 ... 9 bar
  -  - Temperature range  
-40 ... +80°C
  -  - Flow rate  
1240 l/min
- Compressed air regulation and filtering
  - Volume flow boost
  - Reaching a defined end position in the event of a pressure failure
  - Safe exhausting
  - Reversing the effective direction for double-acting pneumatic actuators

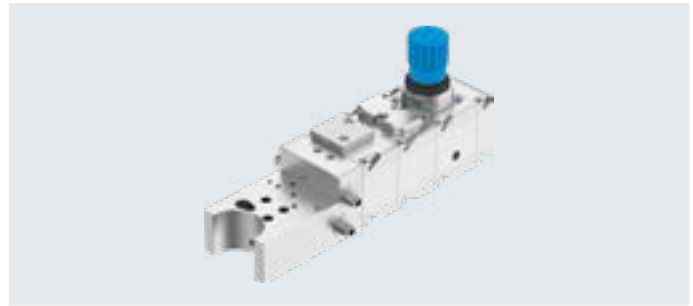

General technical data – Valve terminal VTOP

Size	100 mm
Variants	Manifold block for safety functions, HFT0 prepared for exhausting, VDI/VDE 3845
	Manifold block for safety functions, HFT1 prepared for exhausting, VDI/VDE 3845
	End plate, double-acting, effective direction can be switched
	Filter regulator, pressure range 0.5 ... 12 bar, grade of filtration 40 µm
	Filter regulator, pressure range 0.5 ... 12 bar, grade of filtration 5 µm
	Module for reaching a defined end position in the event of a pressure failure
	Volume booster, double-acting
Volume booster, single-acting	
Mounting position	Any
Operating pressure	0 ... 0.9 MPa
	0 ... 9 bar
	0 ... 130.5 psi
Operating medium	Compressed air to ISO 8573-1:2010 [-:7-:]
	Inert gases
Note on the operating/pilot medium	Lubricated operation not possible
Vibration resistant	Transport application test with severity level 1 to FN 942017-4 and EN 60068-2-6
Shock resistance	Shock test with severity level 1 to FN 942017-5 and EN 60068-2-27
Note on shock resistance	With more than 3 modules, additional mounting requirements are necessary or values are reduced
	Valid for max. 3 modules + end plate
PWIS conformity	VDMA24364 zone III
Type of mounting	With accessories
Pneumatic connection	Sub-base design, airing
Housing material	Smooth-anodised wrought aluminium alloy (20 µm)
Cover material	Smooth-anodised wrought aluminium alloy (20 µm)
Screw material	High-alloy stainless steel
Spring material	Spring steel
Sealing material	EPDM
Sealing material	NBR
Rotary knob material	POM
Filter material	PU
Note on materials	RoHS-compliant



## Datasheet

**General technical data – Adapter plate VABA**

Type	VABA-C13-100-1-F90-G12	VABA-C13-100-2-F90-G12
Design	Adapter for rotary actuator	
Valve connection conforms to standard	VDI/VDE 3847-2	
Size <sup>1)</sup>	240 300 480 700 900	1200 2300
Mounting position	Any	
Pneumatic connection 1	G1/2	
Pneumatic connection 3	G1/2	
Operating medium	Compressed air to ISO 8573-1:2010 [7:7-], inert gases	
Note on the operating/pilot medium	Lubricated operation not possible	
Temperature of medium	-40 ... 80°C	
Ambient temperature	-40 ... 80°C	
Operating pressure	0 ... 0.9 MPa	
	0 ... 9 bar	
	0 ... 130.5 psi	

1) Suitable for DFPD-...-C... → page 4

**General technical data – Pneumatic valve VOGM**

Type	VOGM-FD100-T33H-M-F90	VOGM-FD100-M33E-M-F90
Design	Sub-base valve Diaphragm valve Pilot-actuated piston poppet valve	
Actuation type	Pneumatic	
Sealing principle	Soft	
Mounting position	Any	
Valve function	Proportional 3/3-way valve	
Mode of operation	Double-acting	Single-acting
Reset method	Mechanical spring	
Pneumatic connection	Sub-base design, airing	
Operating medium	Compressed air to ISO 8573-1:2010 [7:7-], inert gases	
Note on the operating/pilot medium	Lubricated operation not possible	
Temperature of medium	-40 ... 80°C	
Ambient temperature	-40 ... 80°C	
Operating pressure	0.14 ... 0.8 MPa	
	1.4 ... 8 bar	
	20.3 ... 116 psi	
Standard nominal flow rate	1240 l/min	
C value	5.58 l/sbar	
b value	0.214	

## Datasheet

**General technical data – Pneumatic valve VOGI**

Design	Sub-base valve Pilot-actuated piston poppet valve
Actuation type	Pneumatic
Sealing principle	Soft
Mounting position	Any
Valve function	4/2-way, monostable Fail safe
Mode of operation	Double-acting
Reset method	Mechanical spring
Pneumatic connection	Sub-base design, airing
Pneumatic connection 1	G1/2
Operating medium	Compressed air to ISO 8573-1:2010 [7:7:-] Inert gases
Note on the operating/pilot medium	Lubricated operation not possible
Temperature of medium	-20 ... 80°C
Ambient temperature	-20 ... 80°C
Operating pressure	0.33 ... 0.8 MPa
	3.3 ... 8 bar
	43.5 ... 116 psi
Standard nominal flow rate	1093 l/min

**General technical data – Sub-base VABP**

Type	VABP-C13-100HFT0-F90-VDE1E	VABP-C13-100HFT1-F90-VDE1E
Design	10o1 channel structure	10o2 channel structure
Mounting position	Any	
Type of mounting	With accessories	
Pneumatic connection	Sub-base design, airing	
Operating medium	Compressed air to ISO 8573-1:2010 [7:7:-] Inert gases	
Note on the operating/pilot medium	Lubricated operation not possible	
PWIS conformity	VDMA24364 zone III	
Temperature of medium	-40 ... 80°C	
Ambient temperature	-40 ... 80°C	
Operating pressure	0 ... 0.8 MPa	
	0 ... 8 bar	
	0 ... 116 psi	

 **Note**

The sub-base VABP is used as an interface for mounting a solenoid valve in accordance with VDI/VDE 3847 for safe exhausting of the actuator and makes the interface available for different safety architectures. The safety-related values are dependent on the specific solenoid valve and the selected safety architecture.

## Datasheet

## General technical data – Filter regulator PCRI

Design	Sub-base valve, directly actuated diaphragm regulator
Actuator lock	Rotary knob with latch
Rotary knob material	POM
Mounting position	Any
Regulator function	Output pressure constant With primary pressure compensation With secondary exhausting
Grade of filtration	5, 40
Filter material	PU
Condensate drain	None
Pneumatic connection	Sub-base design, airing
Pressure indicator	Prepared for G1/4
Operating medium	Compressed air to ISO 8573-1:2010 [-:7:-] Inert gases
Note on the operating/pilot medium	Lubricated operation not possible
Temperature of medium	-40 ... 80°C
Ambient temperature	-40 ... 80°C
Operating pressure	0.1 ... 0.9 MPa 1 ... 9 bar 14.5 ... 130.5 psi
Pressure regulation range	0.05 ... 0.8 MPa 0.5 ... 8 bar 7.25 ... 116 psi
Air purity class at the output	Compressed air to ISO 8573-1:2010 [6:7:-] Compressed air to ISO 8573-1:2010 [7:7:-] Inert gases
Max. pressure hysteresis	0.025 MPa 3,625 psi 0.25 bar
Standard nominal flow rate	1400 l/min

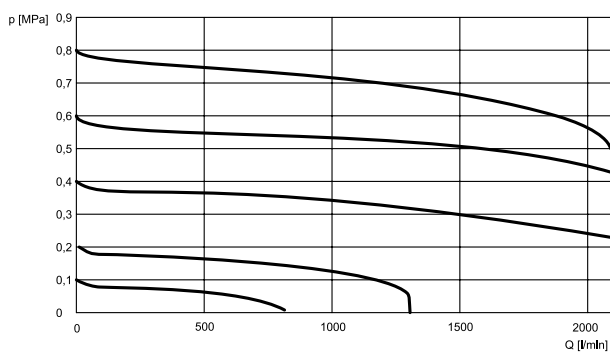
Standard flow rate Q [l/min] as a function of output pressure p<sub>2</sub> (p = 0.8 MPa)

## General technical data – End plate VABE

Design	Without flow control Switchable flow direction
Mounting position	Any
Operating pressure	0 ... 0.8 MPa 0 ... 8 bar 0 ... 116 psi
Operating medium	Compressed air to ISO 8573-1:2010 [7:7:-] Inert gases
Note on the operating/pilot medium	Lubricated operation not possible
Temperature of medium	-40 ... 80°C
Ambient temperature	-40 ... 80°C

Datasheet

Dimensions

Download CAD data → [www.festo.com](http://www.festo.com)

VTOP for quarter turn actuators

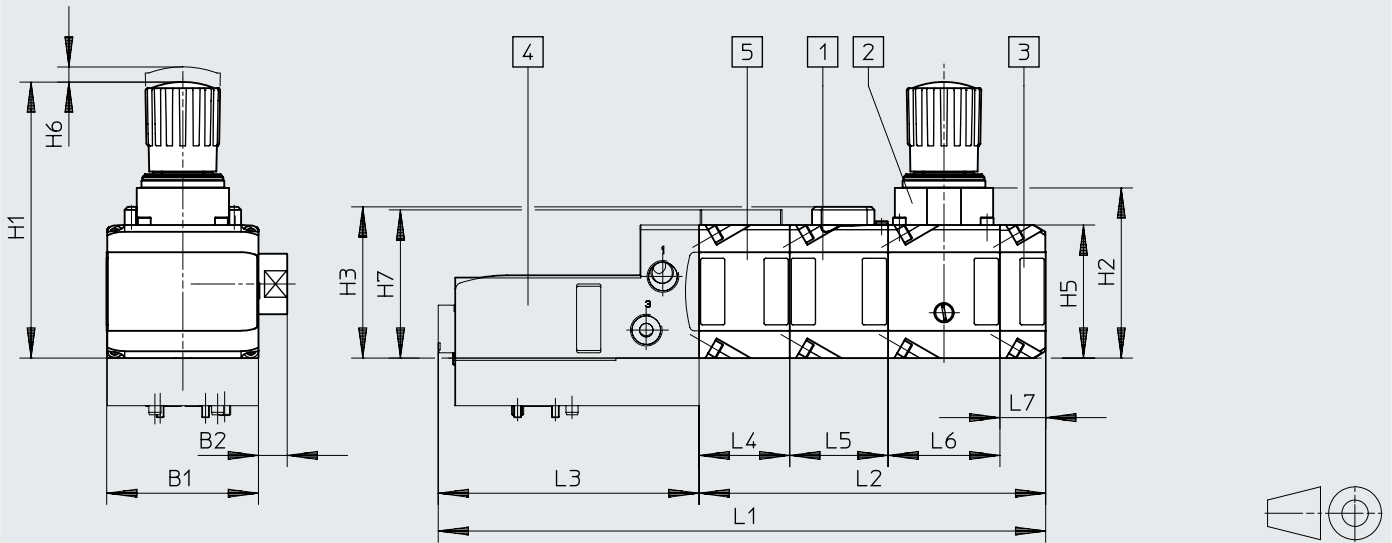

- [1] VOGM-FD100-...
- [2] PCRI-100-F90-12-...
- [3] VABE-C13-100-F90-DU
- [4] VABA-C13-...
- [5] VABP-C13-100HFT-...

	B1	B2	H1	H2	H3	H5	H6	H7	L1	L2	L3	L4	L5	L6	L7
VTOP-100-F90-LTB...-VB...-PC...-EP1	100.3	19	182.9	112.5	100	88	10	98	401.8	229.3	172.5	60	65	74	30.3

Dimensions

Download CAD data → [www.festo.com](http://www.festo.com)

VTOP for linear actuators

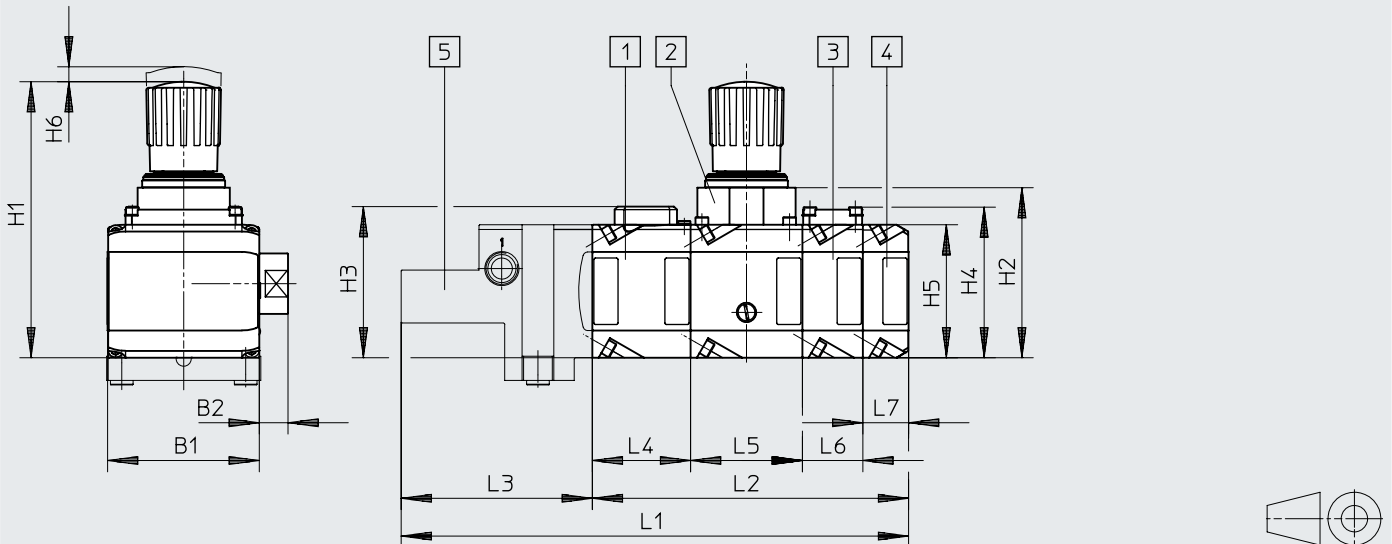

- [1] VOGM-FD100-...
- [2] PCRI-100-F90-12-...
- [3] VOGI-F100FS-...
- [4] VABE-C13-100-F90-DU
- [5] VABA

	B1	B2	H1	H2	H3	H4	H5	H6	H7	L1	L2	L3	L4	L5	L6	L7
VTOP-100-F90-LVB...-PC...-FS1...EP1	100.3	19	182.9	112.5	100	99.6	88	10	98	335.8	209.3	126.5	65	74	40	30.3

Datasheet

Dimensions

Download CAD data → [www.festo.com](http://www.festo.com)

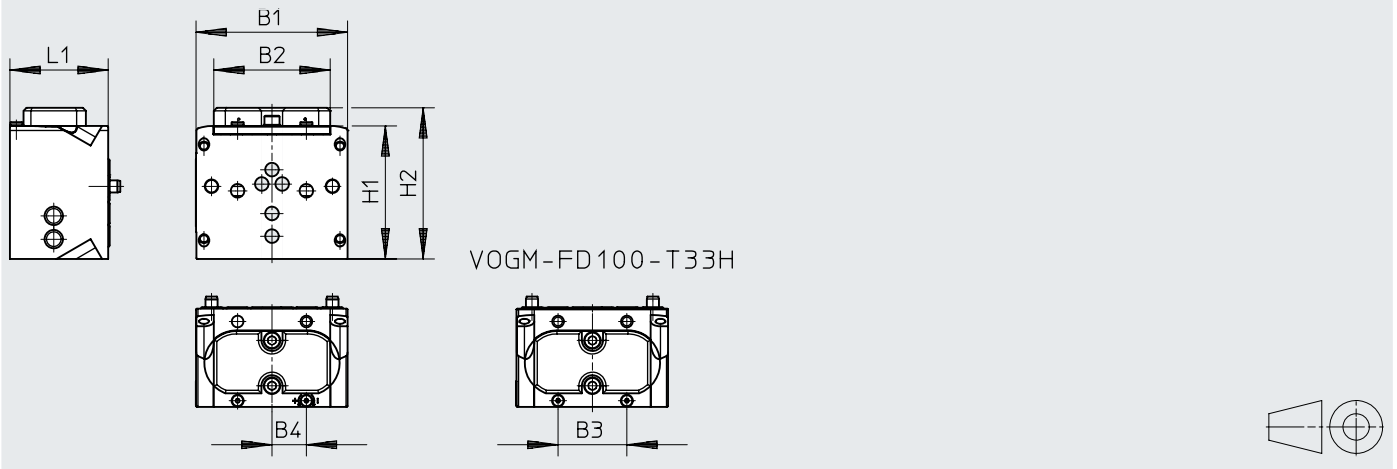

VOGM-FD100-T33H

	B1	B2	B3	B4	H1	H2	L1
VOGM-FD100-T33H-M-F90	100.3	77	45.5	22.8	88	100	65
VOGM-FD100-M33E-M-F90							

Dimensions

Download CAD data → [www.festo.com](http://www.festo.com)

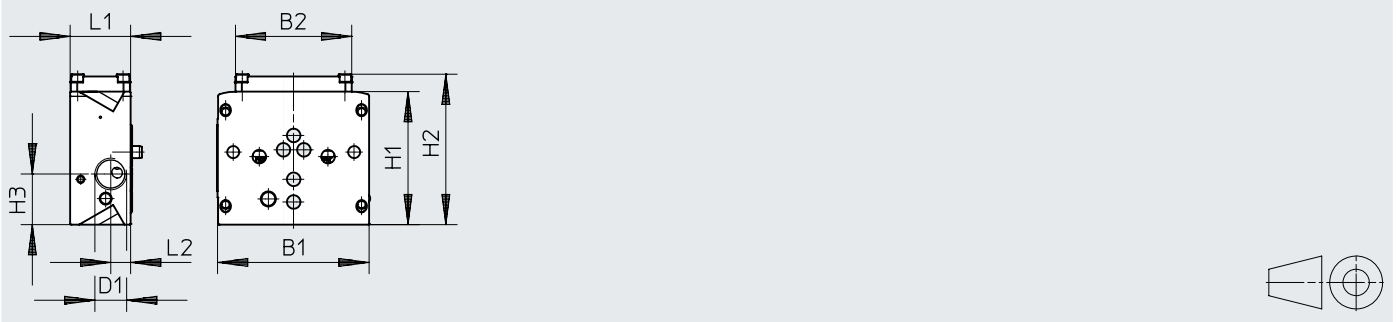

	B1	B2	D1	H1	H2	H3	L1	L2
VOGI-F100FS-T32H-M-F90	100.3	77	G1/2	88	99.6	33.5	40	13.2

Dimensions

Download CAD data → [www.festo.com](http://www.festo.com)

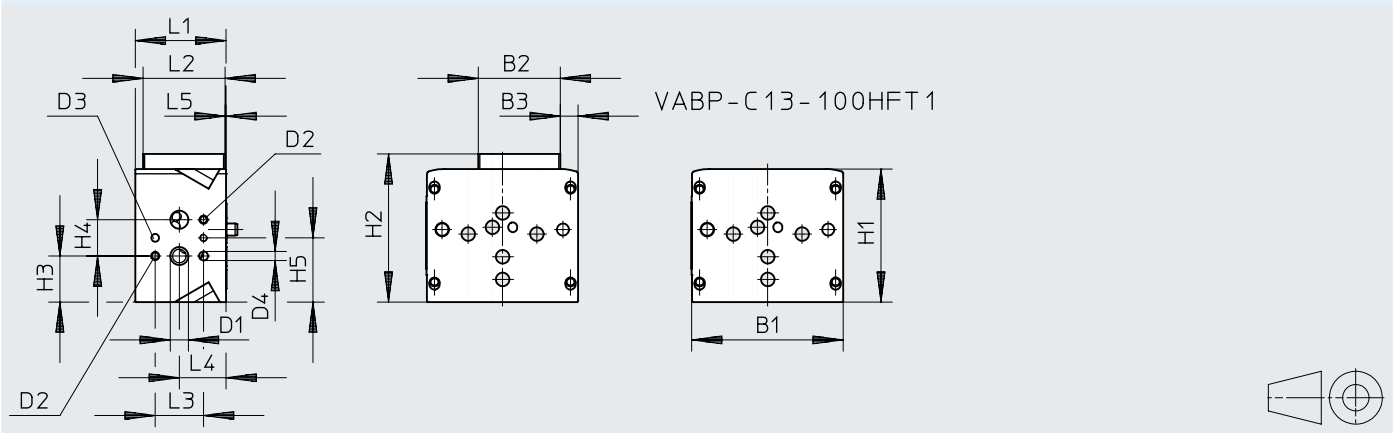

VABP-C13-100HFT 1

	B1	B2	B3	D1 ∅	D2	D3	D4 ∅	H1	H2	H3	H4	H5	L1	L2	L3	L4	L5
VABP-C13-100HFT0-F90-VDE1E	100.3	-	-	12	M5	M5	6	88	-	30.5	24	42.5	60	-	32	30.9	-
VABP-C13-100HFT1-F90-VDE1E		54.2	11.8						98					54.2			0.7

Datasheet

Dimensions

Download CAD data → [www.festo.com](http://www.festo.com)

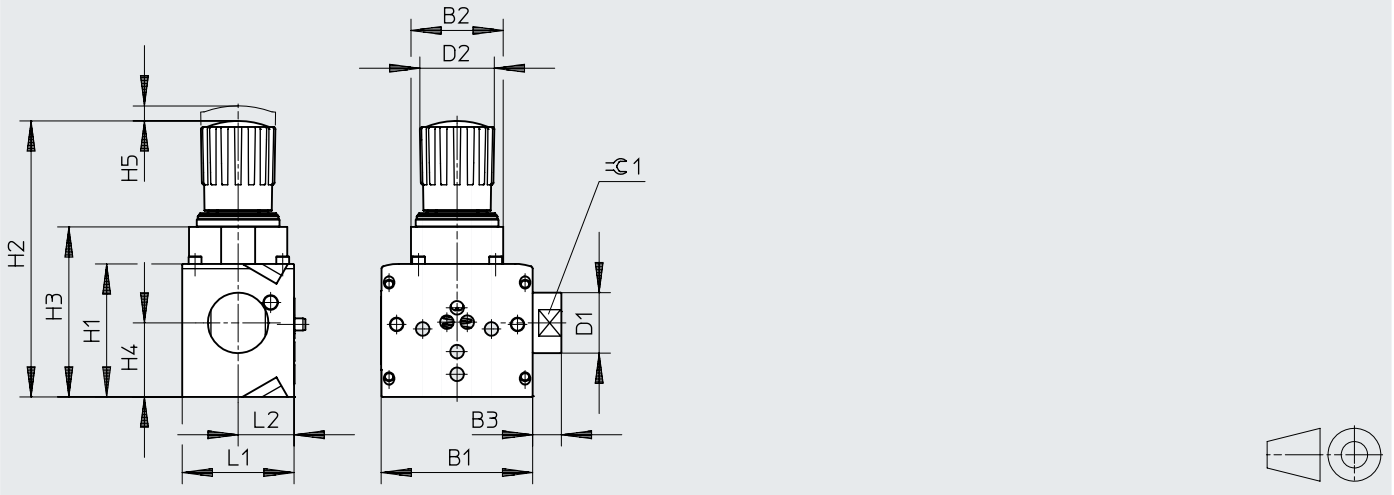

	B1	B2	B3	D1 ∅	D2 ∅	H1	H2	H3	H4	H5	L1	L2	⊖G1
PCRI-100-F90-12-CT3	100.3	61	19	40	~50	88	182.9	112.5	49	~10	74	37	36
PCRI-100-F90-12-ET3													

Dimensions

Download CAD data → [www.festo.com](http://www.festo.com)

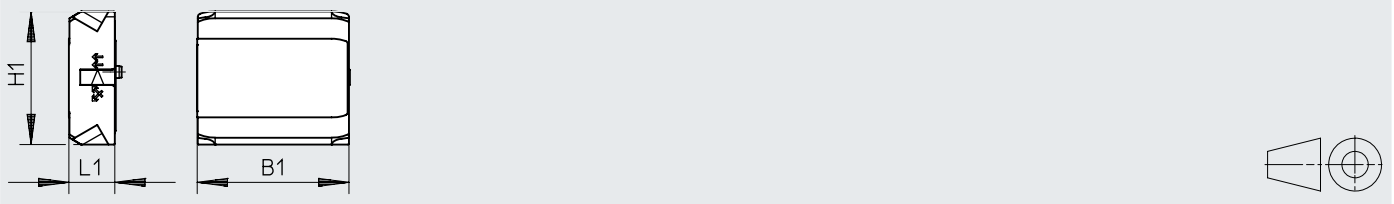



	B1	H1	L1
VABE-C13-100-F90-DU	100.3	88	30.3

## Datasheet

Ordering data – Adapter plate					
	Description	Size <sup>1)</sup>	Product weight	Part no.	Type
	Adapter plate between valve terminal VTOP, pneumatic actuator and positioner	240, 300, 480, 700, 900	2225 g	<b>8141664</b>	<b>VABA-C13-100-1-F90-G12</b>
		1200, 2300	3140 g	<b>8141665</b>	<b>VABA-C13-100-2-F90-G12</b>

1) For quarter turn actuators DFPD-...-C-VDE2

Ordering data – Pneumatic valve					
	Description	Mode of operation	Product weight	Part no.	Type
	For boosting the compressed air flow rate specified by the positioner	Double-acting	1560 g	<b>8141659</b>	<b>VOGM-FD100-T33H-M-F90</b>
		Single-acting		<b>8141658</b>	<b>VOGM-FD100-M33E-M-F90</b>

Ordering data – Pneumatic valve					
	Description	Mode of operation	Product weight	Part no.	Type
	Fail safe module for reaching a defined end position in the event of a pressure failure	Double-acting	880 g	<b>8141660</b>	<b>VOGI-F100FS-T32H-M-F90</b>

Datasheet

Ordering data – Sub-base					
	Description	Design	Product weight	Part no.	Type
	With interface HFT 0 for safe exhausting	1oo1 channel structure	1300 g	<b>8141661</b>	<b>VABP-C13-100HFT0-F90-VDE1E</b>
	With interface HFT 1 for safe exhausting	1oo2 channel structure	1365 g	<b>8141662</b>	<b>VABP-C13-100HFT1-F90-VDE1E</b>

Ordering data – Filter regulator					
	Grade of filtration	Product weight	Part no.	Type	
	5 µm	1950 g	<b>8141656</b>	<b>PCRI-100-F90-12-C-T3</b>	
	40 µm		<b>8141657</b>	<b>PCRI-100-F90-12-E-T3</b>	

Ordering data – End plate					
	Description	Product weight	Part no.	Type	
	For sealing the valve terminal VTOP and setting the effective direction	645 g	<b>8141663</b>	<b>VABE-C13-100-F90-DU</b>	



## Ordering data – Modular product system

Ordering table		Conditions	Code	Enter code
VTOP-...				
Module no.	<b>8141655</b>			
Product type	VTOP		<b>VTOP</b>	VTOP
Size	100 mm		<b>-100</b>	-100
Compressed air supply connection	Flange, nominal width 9 mm		<b>-F90</b>	-F90
Compressed air supply connection position	Left		<b>L</b>	L
Position function	End plate, double-acting, effective direction can be switched	[1]	<b>-EP1</b>	
	Module for reaching a defined end position in the event of a pressure failure	[2]	<b>-FS1</b>	
	Filter regulator, pressure range 0.5 ... 12 bar, grade of filtration 5 µm	[3]	<b>-PC1</b>	
	Filter regulator, pressure range 0.5 ... 12 bar, grade of filtration 40 µm		<b>-PC2</b>	
	Manifold block for safety functions, HFT0 prepared for exhausting, VDI/VDE 3845 extended	[4]	<b>-TB3</b>	
	Manifold block for safety functions, HFT1 prepared for exhausting, VDI/VDE 3845 extended	[4]	<b>-TB4</b>	
	Volume booster, single-acting	[5]	<b>-VB1</b>	
Volume booster, double-acting	[6]	<b>-VB2</b>		

- [1] EP1 End plate must always be selected and must always be the final module
- [2] FS1 Not in combination with TB3, TB4
- [3] PC1 Not in combination with PC2
- [4] Multiple identical modules not possible with the exception of -TB3 and -TB4  
Possible variants:
- TB3 & TB3
  - TB3 & TB4
  - TB4 & TB3
  - TB4 & TB4
- [5] VB1 Not in combination with VB2
- [6] VB2 Not in combination with VB1

Accessories

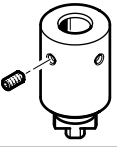
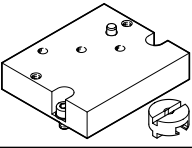
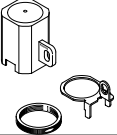
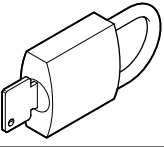
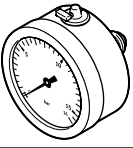
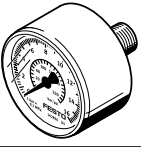
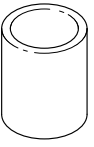
Coupling CAFM				
	Description	Part no.	Type	
	Coupling for connecting the shaft of positioners with the interface according to VDI/VDE 3847-2 and quarter turn actuator	8154714	CAFM-M1-CK-N3	
Adapter kit DADG				
	Description	Part no.	Type	
	Adapter kit for mounting VTOP on quarter turn actuator DFPD-2300-...-VDE2	8104804	DADG-AK-F9-2	
Regulator lock LRVS				
	Description	Product weight	Part no.	Type
	Regulator lock to prevent unauthorised adjustment of the set pressure of pressure and filter regulators	60 g	193782	LRVS-D-MIDI
Padlock LRVS-D				
	Product weight	Part no.	Type	
	120 g	193786	LRVS-D	
Pressure gauge PAGN				
	Nominal size, pressure gauge	Pneumatic connection	Part no.	Type
	63	G1/4	8081401	PAGN-63-16-G14-R1-1.6-0.5-V2
Pressure gauge MA				
	Nominal size, pressure gauge	Pneumatic connection	Part no.	Type
	40	G1/4	183901	MA-40-16-G1/4-EN
Filter cartridge LFP				
	Size	Grade of filtration	Part no.	Type
	Midi	5 µm	159594	LFP-D-MIDI-5M

## Accessories

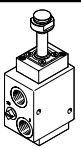

Valve VOFC	Valve function	Nominal width	Pneumatic working port <sup>1)</sup>	Part no.	Type
	3/2-way, closed, single solenoid	6 ... 12 mm	Sub-base G1/4 G1/2 1/4 NPT 1/2 NPT	<b>2868687</b>	<b>VOFC-LT-...-FGP14-...-F19</b>

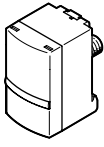
1) Configuration-dependent

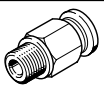
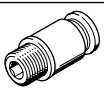
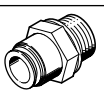
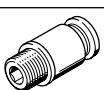
Pressure sensor SPAU	Pneumatic connection	Switching output	Display type	Electrical connection 1, connection technology	Part no.	Type
	Male thread R1/4	2 x PNP or 2 x NPN switchable	Illuminated LCD	M12x1, A-coded to EN 61076-2-101	<b>8001208</b>	<b>SPAU-P10R-T-R14M-L-PNLK-PNVBA-M12D</b>
				M8x1 A-coded to EN 61076-2-104	<b>8001209</b>	<b>SPAU-P10R-T-R14M-L-PNLK-PNVBA-M8D</b>

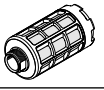
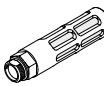
Push-in fitting QS	Connection		Nominal width	Packaging unit [items]	Part no.	Type
	R1/2	Male thread with external hex	11 mm	1	<b>153010</b>	<b>QS-1/2-12</b>
			11 mm	20	<b>130684</b>	<b>QS-1/2-12-20</b>
		Male thread with internal hex	8.4 mm	1	<b>153021</b>	<b>QS-1/2-12-I</b>
	G1/2	Male thread with external hex	11 mm	1	<b>186104</b>	<b>QS-G1/2-12</b>
			11 mm	20	<b>132046</b>	<b>QS-G1/2-12-20</b>
		Male thread with internal hex	8.4 mm	1	<b>186115</b>	<b>QS-G1/2-12-I</b>

Silencer U	Connection	Version	Ambient temperature	Packaging unit [items]	Part no.	Type
	G1/2	Polymer	-10 ... +70°C	20	<b>534225</b>	<b>U-1/2-20</b>
				1	<b>2310</b>	<b>U-1/2</b>
		Metal		1	<b>6844</b>	<b>U-1/2-B</b>

Silencers AMTE	Connection	Version	Ambient temperature	Packaging unit [items]	Part no.	Type
	G1/2	Metal	-40 ... +80°C	10	<b>1206625</b>	<b>AMTE-M-H-G12</b>
				1	<b>1205863</b>	<b>AMTE-M-LH-G12</b>