

Solenoid valve VSNC-G1/8

FESTO

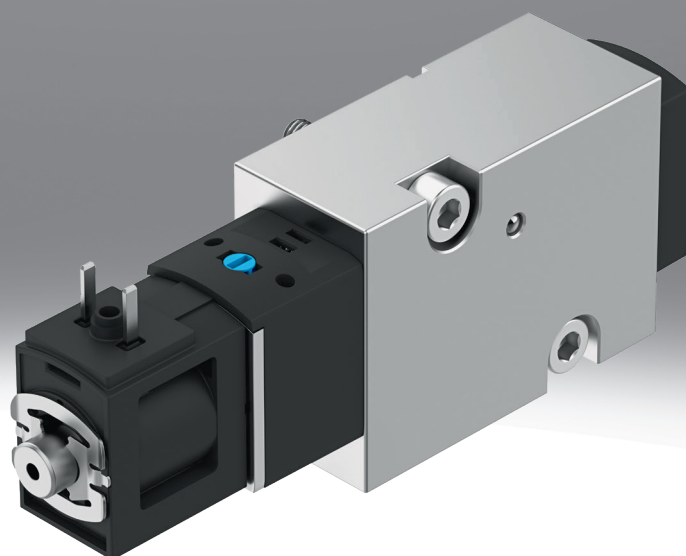

Characteristics

At a glance

The Namur valve VSNC is designed for the requirements of the process industry as well as factory automation. It can be mounted on all G1/8 drives with NAMUR port pattern according to VDI/VDE 3845. This series is an extension of the VSNC product group in the piston slide design, which is smaller and cost-effective.

Function:

VSNC valves are pilot valves for single- and double-acting quarter turn and linear drives with port pattern according to VDI/VDE 3845 such as DAPS, DFPD, DLP. With the corresponding accessories available, such as a connection kit, mounting on drives without a NAMUR interface, such as diaphragm actuators, is also possible. They are designed for the requirements of process automation. Mechanical springs (monostable valves) ensure safe switching to the initial position in the event of a power failure. Working ports 2 and 4 are designed according to VDI/VDE 3845 NAMUR.

Additional function

[] Without

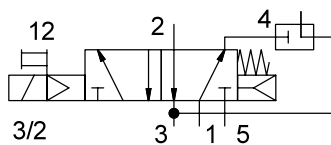
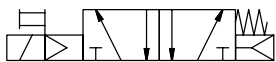

The VSNC-G1/8 has two selectable basic positions in the de-energized state for each valve function (3/2 or 5/2-way valve). In the “classic” basic position, the passage from 1 to 4 is pressurized, whereas port 2 is exhausted to 3 (VSNC-...-FK-...). For this purpose, the “WITHOUT” feature must be selected for the additional function.

Note: Generally, the 3/2-way valve function has an integrated exhaust return (spring chamber blanketing) and thus protects the spring chamber of the drive from influences from the environment.

[A] Connections exchanged

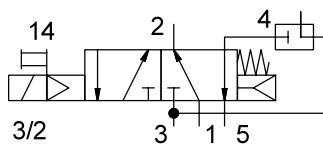
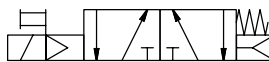

Another possibility is the configuration VSNC-FKA-... in which the basic position is pressurized from 1 to 2 and exhausted from 4 to 5 (connections swapped). This gives them the possibility of keeping the valve orientation/valve mounting always the same in their quarter turn actuator, while changing the direction of rotation of the quarter turn actuator.

Type code

001	Series	006	Reset method for monostable pneumatic valves
VSNC	Solenoid valve VSNC	R	Mixed, pneumatic/mechanical spring
002	Directional control valve type	007	Manual override
F	Flanged valve	D	Non-detenting, detenting
003	Design principle	008	Pneumatic connection
K	Piston slide with sealing ring	G18	G1/8
004	Additional function	009	Nominal operating voltage
	Without	1	24 V DC
A	Connections exchanged	010	Electrical connection
005	Valve function	C1	Plug pattern type C, according to EN 175301-803
M52	5/2-way valve, monostable	011	Version
M32C	3/2-way valve, normally closed	S	Core features

Datasheet

General technical data

Valve function	3/2, closed, monostable, 5/2, monostable, Connections exchanged
Width	25.5 mm
Structural design	Piston slide with sealing ring
Sealing principle	Soft
Actuation type	Electrical
Reset method	Mechanical spring, Pneumatic spring
Type of control	Pilot-controlled
Manual override	Detenting
Exhaust air function	With flow control option
Venting hole connection	Not ducted
Pilot air supply port	Internal
Type of mounting	With through-hole
Mounting position	Any
Standard nominal flow rate	400 l/min
Standard nominal flow rate, exhaust air return 4->3	100 l/min
b-value	0.3
C value	2.1 l/sbar
Pneumatic connection 1	G1/8
Pneumatic connection 2	NAMUR connection diagram
Pneumatic connection 3	G1/8
Pneumatic connection 4	NAMUR connection diagram
Pneumatic connection 5	G1/8
Conforms to standard	VDI/VDE 3845 (NAMUR)
Product weight	220 g

Operating and environmental conditions

Valve function	3/2, closed, monostable, 5/2, monostable, Connections exchanged
Operating medium	Compressed air as per ISO 8573-1:2010 [7:4:4]
Information on operating and pilot media	Operation with oil lubrication possible (required for further use)
Operating pressure	2.5 ... 8 bar
Ambient temperature	-20 ... 50°C
Temperature of medium	-20 ... 50°C
Corrosion resistance class (CRC) ¹⁾	1 - Low corrosion stress
Degree of protection	IP65

1) Further information www.festo.com/x/topic/kbk

Electrical data

Valve function	3/2, closed, monostable, 5/2, monostable, Connections exchanged
Electrical connection	Form C
Coil characteristics	24 V DC: 2.4 W
Duty cycle	100%
On switching time	≤50 ms
Switching time off	≤50 ms

Materials

Type code	VSNC
Housing material	Wrought aluminum alloy
Seals material	NBR
Material of screws	High-alloy stainless steel

Dimensions

Dimensions – 3/2 – 5/2-way valve

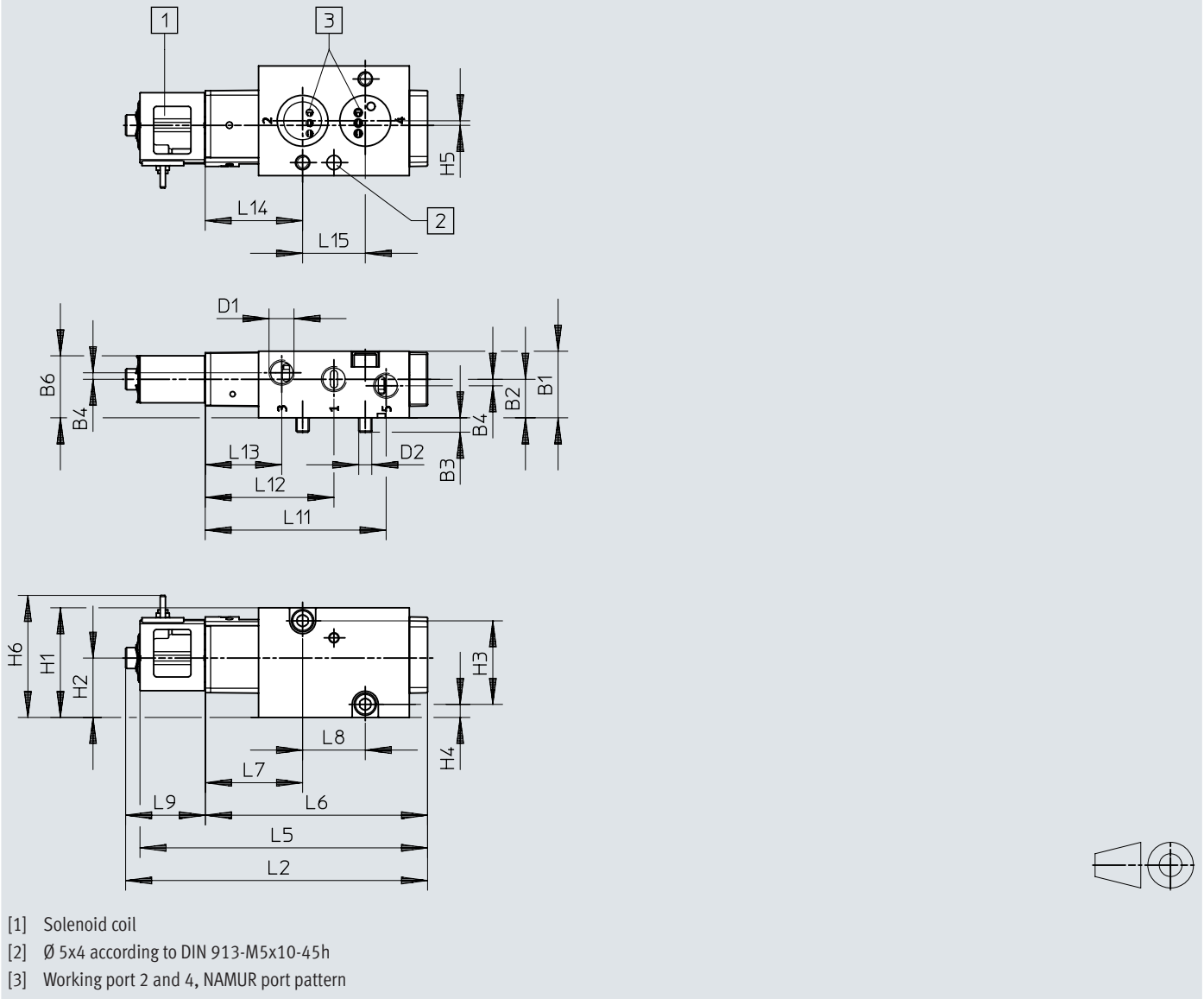
Download CAD data → www.festo.com

	B1	B2	B3	B4	B6	D1	D2	H1	H2	H3	H4	H5
VSNC-FK-M52-RD-G18-1C1-S	25,5	14,8	5,5	2,5	23,8	G1/8	M5	42	22,7	32	5	1,7
VSNC-FKA-M52-RD-G18-1C1-S												
VSNC-FK-M32C-RD-G18-1C1-S												
VSNC-FK-M32C-RD-G18-1C1-S												
	H6	L2	L5	L6	L7	L8	L9	L11	L12	L13	L14	L15
VSNC-FK-M52-RD-G18-1C1-S	46,8	115,7	110,2	85,2	37,4	24	30,5	69,4	49,4	29,4	37,4	24
VSNC-FKA-M52-RD-G18-1C1-S												
VSNC-FK-M32C-RD-G18-1C1-S												
VSNC-FK-M32C-RD-G18-1C1-S												

Dimensions

Dimensions – Connecting plate

Download CAD data → www.festo.com

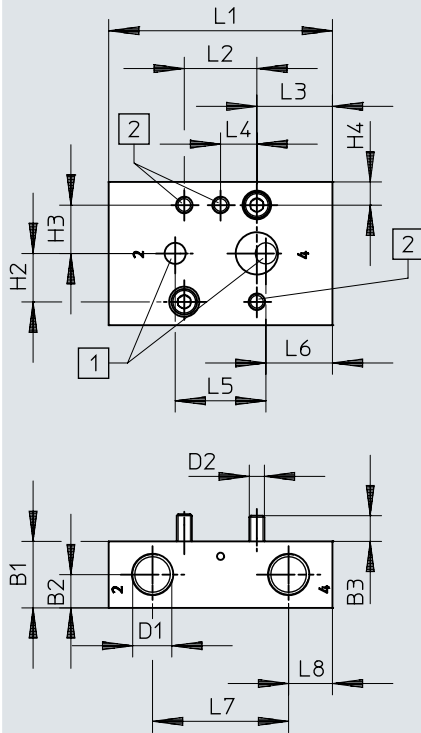

- [1] Working port 2 and 4, NAMUR port pattern
- [2] Hole for M5 thread

	B1	B2	B3	D1	D2	H1	H2	H3	H4	L1	L2	L3	L4	L5	L6	L7	L8
VABS-B14-T-FG14	22	11	8,5	G1/4	M5	47,4	16	16	7,7	74	24	25	12	30	22	45	14,5
VABS-B14-T-FN14				1/4 NPT													

Dimensions

Dimensions – Throttle plate VABF-...P1

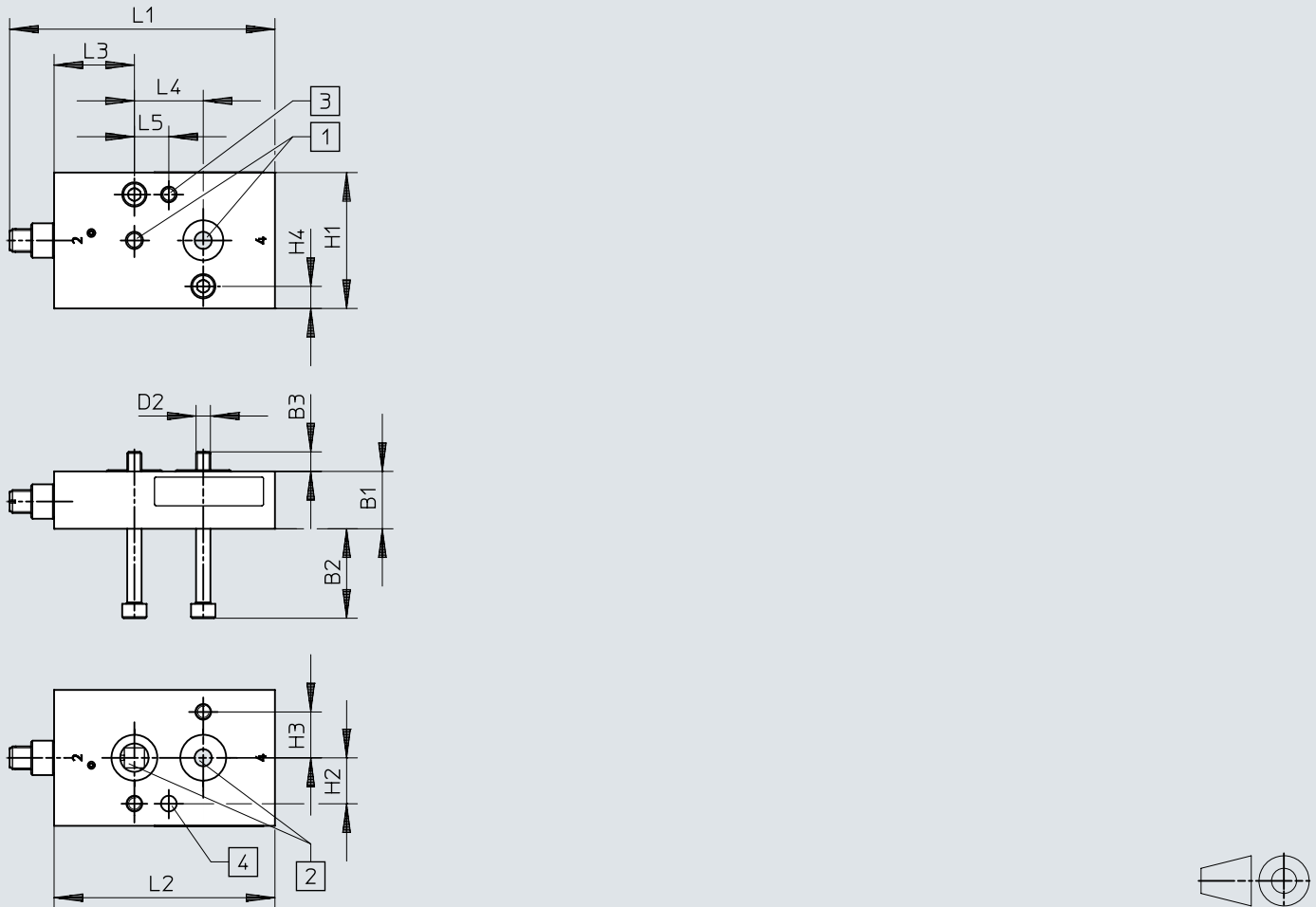
Download CAD data → www.festo.com

- [1] "NAMUR" port pattern 1/4
 [2] "NAMUR" port pattern 1/4
 [3] Hole for M5 thread
 [4] Bore 5.5 mm \varnothing for threaded pin according to DIN 913-M5x10-45H)

	B1	B2	B3	D2	H1	H2	H3	H4	L1		L2	L3	L4	L5
									min.	max.				
VABF-B14-F1B1P1-FF14	20	31,2	6,8	M5	47,4	16	16	7,7	86,5	92,5	77	28	24	12

Dimensions

Dimensions – Throttle plate VABF-...P2

Download CAD data → www.festo.com

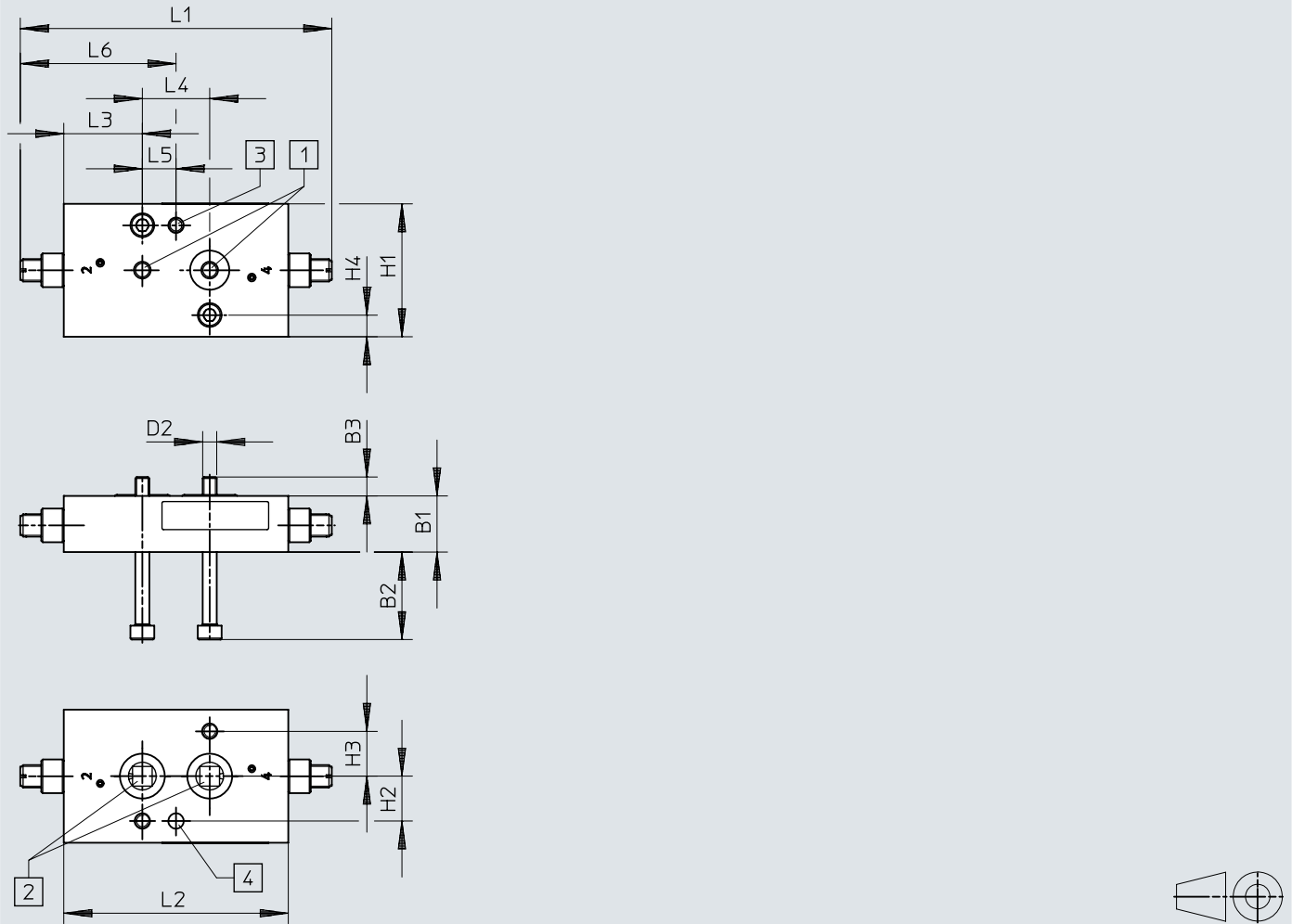

- [1] “NAMUR” port pattern 1/4
- [2] “NAMUR” port pattern 1/4
- [3] Hole for M5 thread
- [4] Bore 5.5 mm Ø for threaded pin according to DIN 913-M5x10-45H)

	B1	B2	B3	D2	H1	H2	H3	H4	L1		L2	L3	L4	L5	L6	
									min.	max.					min.	max.
VABF-B14-F1B1P2-FF14	20	31,2	6,8	M5	47,4	16	16	7,7	99	110	80	28	24	12	49,5	55,5

Dimensions

Dimensions – Exhaust plate

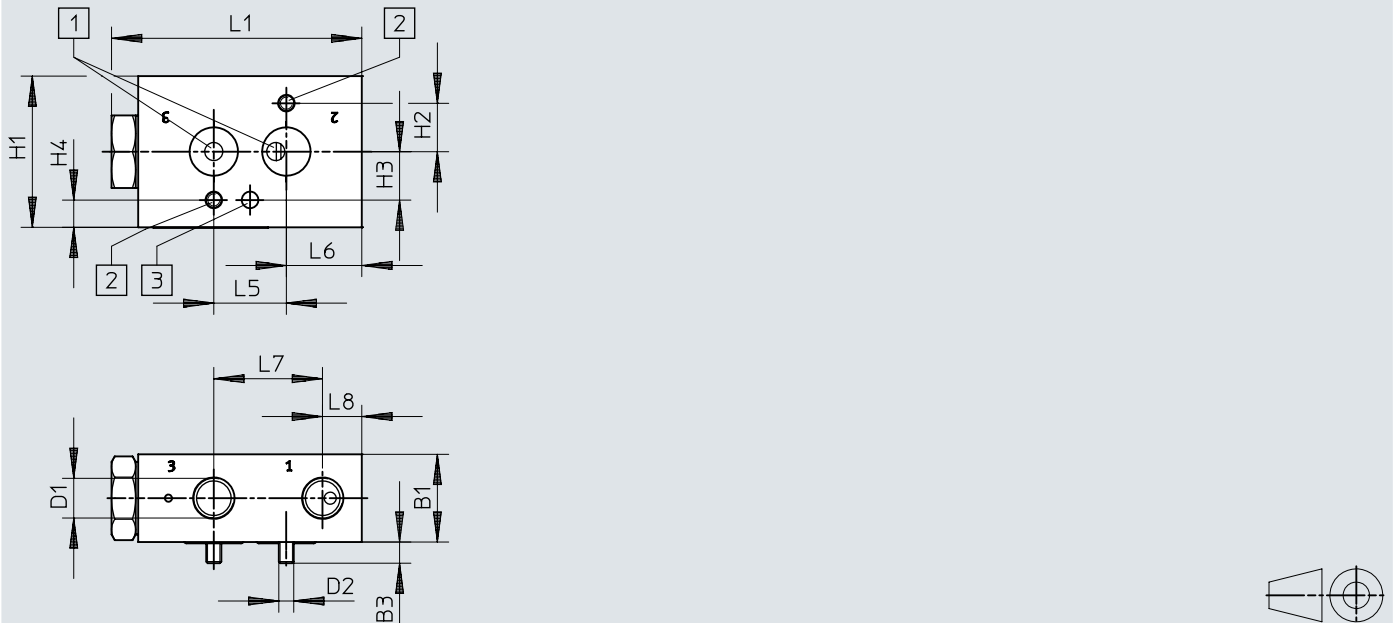
Download CAD data → www.festo.com

- [1] "NAMUR" port pattern 1/4
 [2] Hole for thread
 [3] Bore 5.5 mm Ø for threaded pin according to DIN 913-M5x10-45H)

	B1	B3	D1	D2	H1	H2	H3	H4	L1	L5	L6	L7	L8
VABF-B14-M3-G14	29	7	G1/4	M5	50	16	16	9	82,8	24	25	36	13
VABF-B14-M3-N14			1/4 NPT										

Dimensions

Dimensions – Mounting plate VABS-B14-90-FF14

Download CAD data → www.festo.com

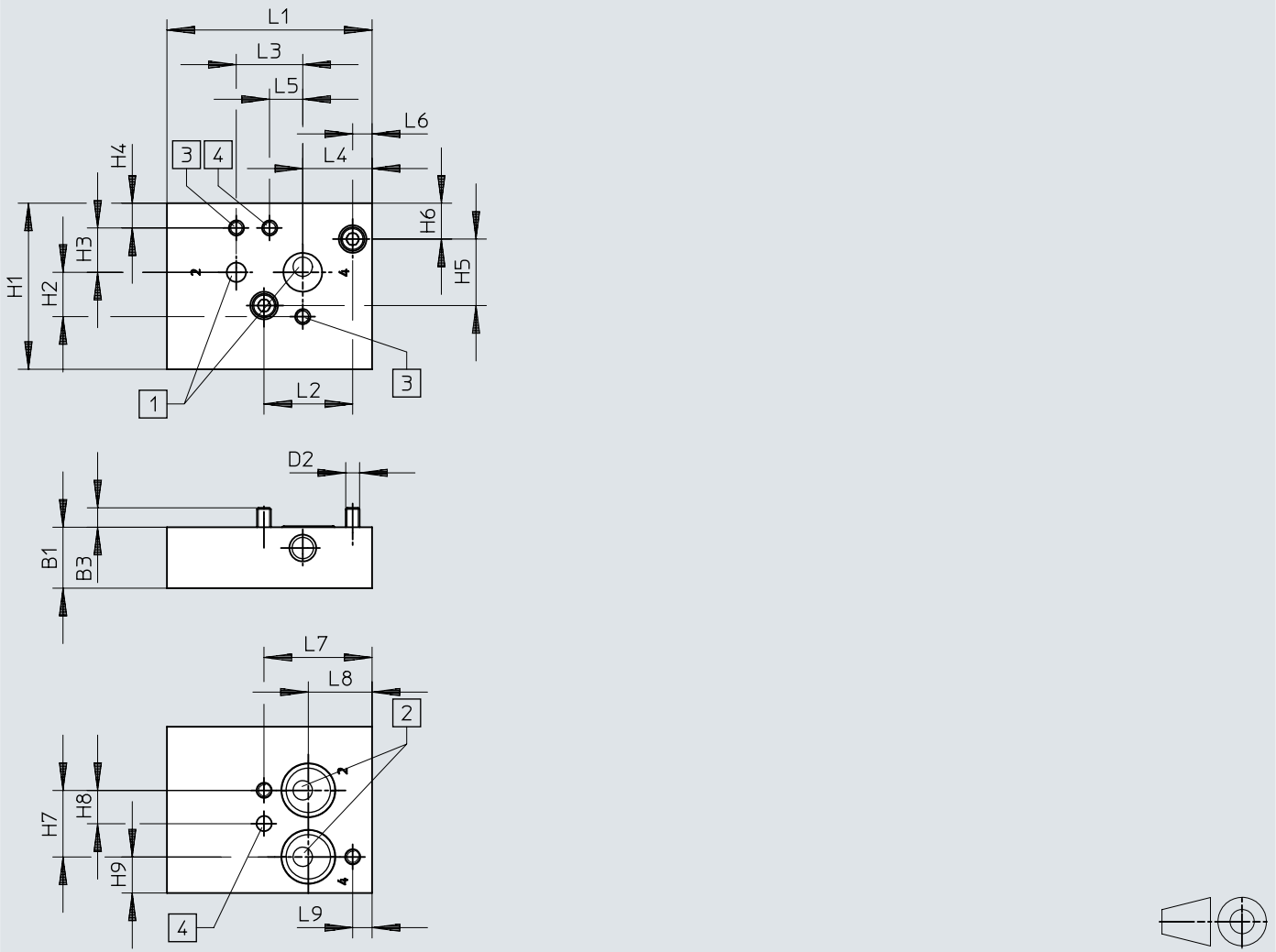

- [1] “NAMUR” port pattern 1/4
- [2] “NAMUR” port pattern 1/4
- [3] Hole for M5 thread
- [4] Bore 5.5 mm Ø for threaded pin according to DIN 913-M5x10-45H)

	B1	B3	D2	H1	H2	H3	H4	H5	H6	H7	H8
VABS-B14-90-FF14	22	7	M5	60	16	16	9	24	13	24	12

	H9	L1	L2	L3	L4	L5	L6	L7	L8	L9
VABS-B14-90-FF14	13	74	32	24	25	12	7	39	23	7

Dimensions

Dimensions – Mounting plate VABS-B14-180-FF14

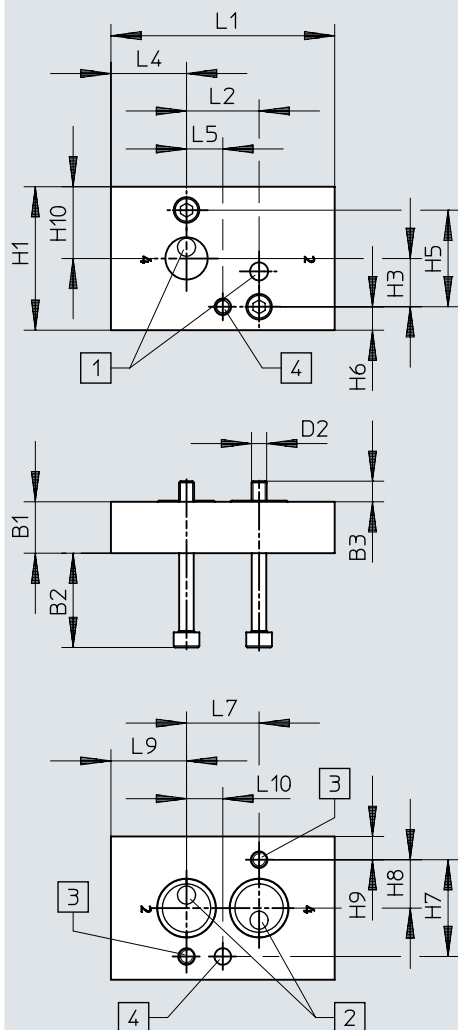
Download CAD data → www.festo.com

- [1] "NAMUR" port pattern 1/4
 [2] "NAMUR" port pattern 1/4
 [3] Hole for M5 thread
 [4] Bore 5.5 mm \varnothing for threaded pin according to DIN 913-M5x10-45H

	B1	B2	B3	D2	H1	H3	H5	H6	H7	H8	H9	H10	L1	L2	L4	L5	L7	L9	L10
VABS-B14-180-FF14	17	31,2	6,8	M5	47,4	16	32	7,7	32	16	7,7	23,7	74	24	25	12	24	25	12

Dimensions

Dimensions – Mounting plate VABS-B14-270-FF14

Download CAD data → www.festo.com

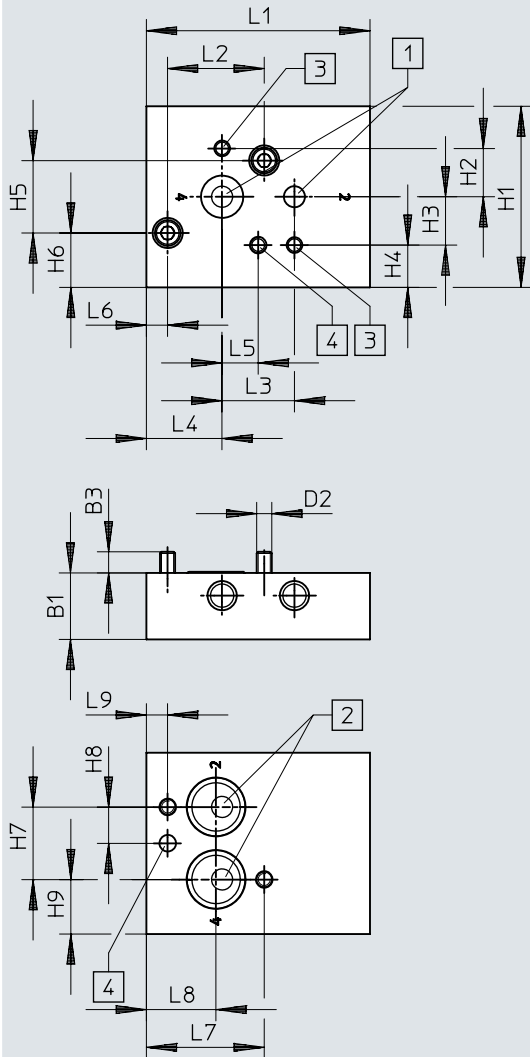

- [1] “NAMUR” port pattern 1/4
- [2] “NAMUR” port pattern 1/4
- [3] Hole for M5 thread
- [4] Bore 5.5 mm \varnothing for threaded pin according to DIN 913-M5x10-45H)

	B1	B3	D2	H1	H2	H3	H4	H5	H6	H7	H8
VABS-B14-270-FF14	22	7	M5	60	16	16	14	24	18	24	12
	H9	L1	L2	L3	L4	L5	L6	L7	L8	L9	
VABS-B14-270-FF14	18	74	32	24	25	12	7	39	23	7	

Dimensions

Dimensions – Mounting plate VABA-B14-FL12-FL14

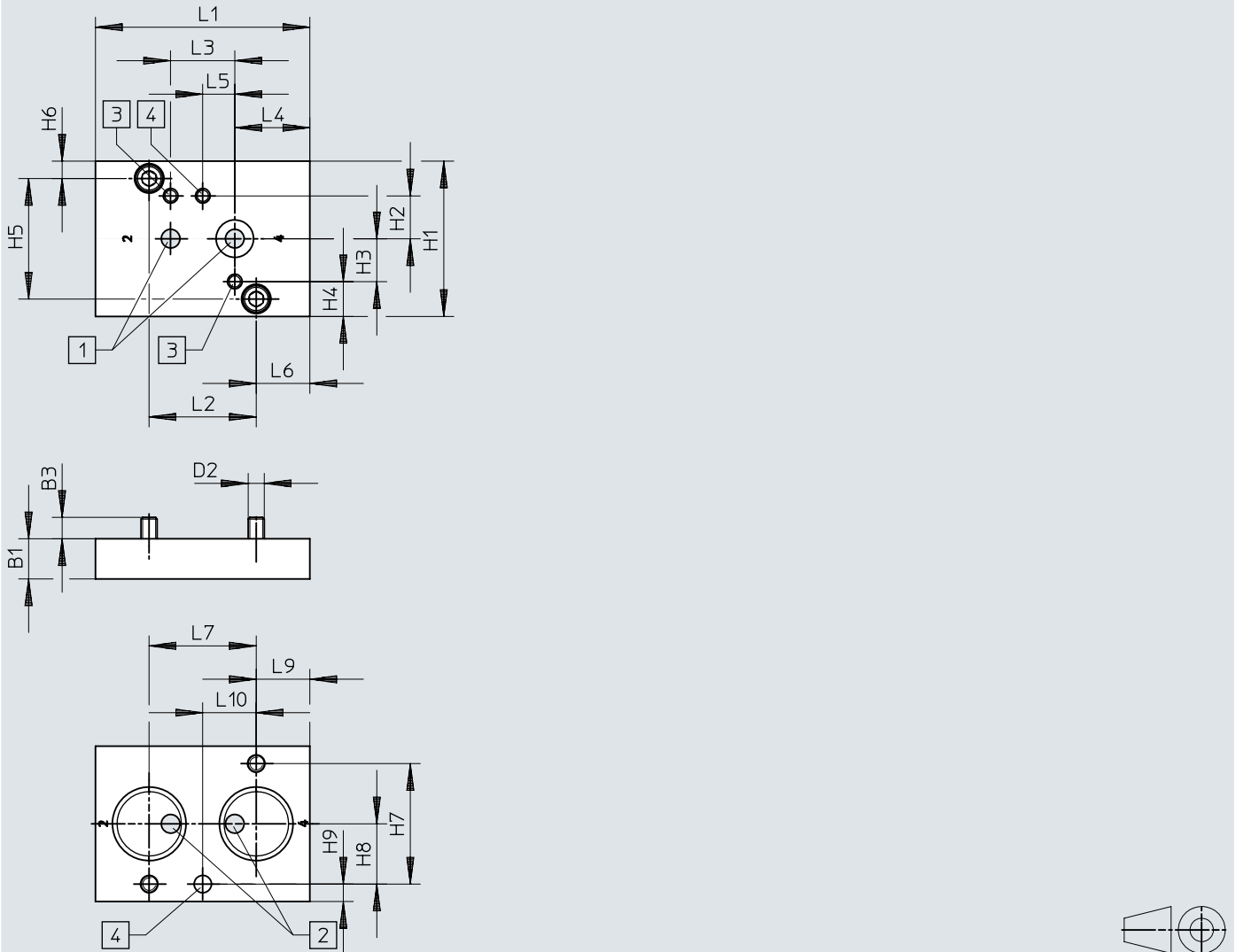
Download CAD data → www.festo.com

- [1] “NAMUR” port pattern 1/4
 [2] “NAMUR” port pattern 1/2
 [3] Hole for M5 thread
 [4] Bore 5.5 mm Ø for threaded pin according to DIN 913-M5x10-45H)

	B1	B3	D2	H1	H2	H3	H4	H5	H6	H7	H8
VABA-B14-FL12-FL14	15	8	M6	58	16	16	13	45	6,5	45	22,5

	H9	L1	L2	L3	L4	L5	L6	L7	L9	L10
VABA-B14-FL12-FL14	6,5	80	40	24	28	12	20	40	20	20

Ordering data

Ordering data				
	Valve function	Width	Part no.	Type
	3/2, closed, monostable, Connections exchanged	25.5 mm	8166612	VSNC-FKA-M32C-RD-G18-1C1-S
	3/2, closed, monostable		8166611	VSNC-FK-M32C-RD-G18-1C1-S
	5/2, monostable, Connections exchanged		8128473	VSNC-FKA-M52-RD-G18-1C1-S
	5/2, monostable		8128472	VSNC-FK-M52-RD-G18-1C1-S

Peripherals overview

Peripherals overview VSNC...-G1/8

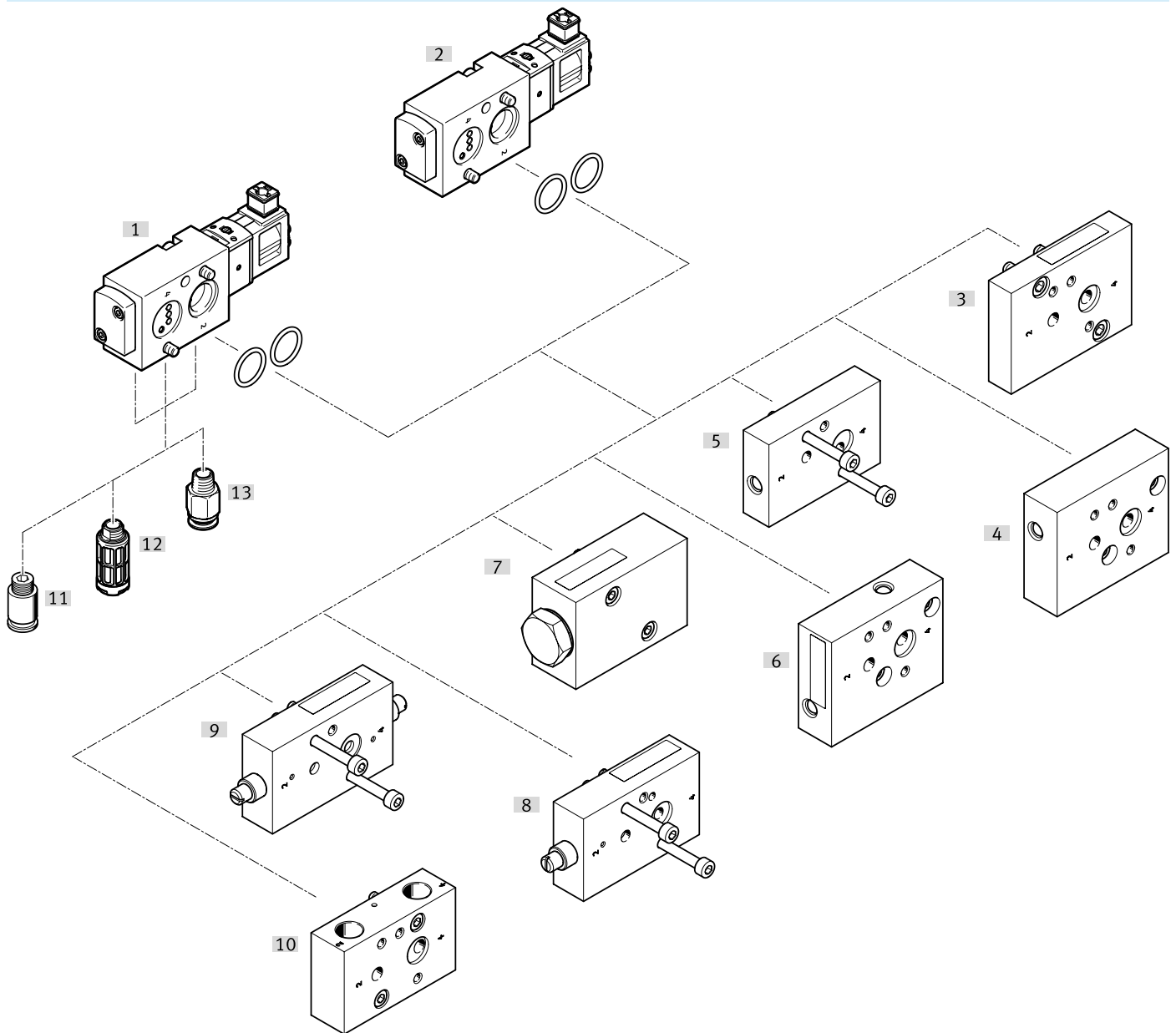

Accessories			→ Page/Internet
Type/order code	Description		
[1] Solenoid valves VSNC...-M32C...	3/2 way valve monostable, plastic cover, brass armature tube for controlling single-acting or double-acting drives	vsnc	
[2] Solenoid valves VSNC...-M52...	5/2 way valve monostable, plastic cover, brass armature tube for controlling double-acting drives	vsnc	
[3] Mounting plate VABA-B14-FL12-FL14	Mounting plate with NAMUR connection 1/2 and 1/4	17	
[4] Mounting plate VABS-B14-270-FF14	NAMUR connection can be rotated 270°. It is additionally possible to mount a 1/4" NAMUR valve on a 1/2" actuator	17	
[5] Mounting plate VABS-B14-180-FF14	NAMUR connection can be rotated 180°. It is additionally possible to mount a 1/4" NAMUR valve on a 1/2" actuator	17	
[6] Mounting plate VABS-B14-90-FF14	Namur connection can be rotated 90°. It is also possible to mount a 1/4" NAMUR valve on a 1/2" actuator	17	
[7] Exhaust plate VABF-B14-M3-...14	Venting of a quarter turn actuator with NAMUR connection via a valve manifold or a normal inline valve G 1/4 or 1/4 NPT	17	
[8] Throttle plate (single-acting) VABF-B14-F1B1P1-FF14	Flow control for single-acting quarter turn actuators	18	
[9] Throttle plate (double acting) VABF-B14-F1B1P2-FF14	Flow control for double-acting quarter turn actuators	18	

Peripherals overview

Accessories		→ Page/Internet
Type/order code	Description	
[10] Connector plate VABS-B14-T-F ... 14	With the sub-base, it is possible to use the NAMUR valve as an inline valve with G1/4" and NPT1/4" thread	18
[11] Push-in fitting QS	For connecting tubing with standard O.D.	18
[12] Silencer	-	19
[13] Cover cap	Exhaust protection IP65. The spring chamber of the actuator is protected against the ingress of aggressive ambient air and water by the non-return system	19

Accessories

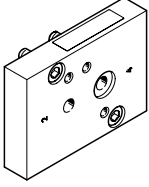
Mounting plate VABA-B14-FL12-FL14					
	Type of mounting	Operating pressure	Corrosion resistance class (CRC)	Part no.	Type
	With through-hole	1.5 ... 10 bar	2 - Moderate corrosion stress	8098889	VABA-B14-FL12-FL14

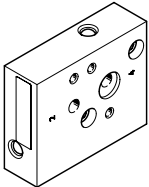
Mounting plate VABS-B14-270-FF14					
	Type of mounting	Operating pressure	Corrosion resistance class (CRC)	Part no.	Type
	With through-hole	1.5 ... 10 bar	2 - Moderate corrosion stress	8098891	VABS-B14-270-FF14

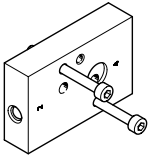
Mounting plate VABS-B14-180-FF14					
	Type of mounting	Operating pressure	Corrosion resistance class (CRC)	Part no.	Type
	With through-hole	1.5 ... 10 bar	2 - Moderate corrosion stress	8099347	VABS-B14-180-FF14

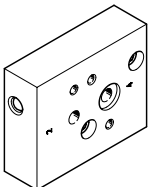
Mounting plate VABS-B14-90-FF14					
	Type of mounting	Operating pressure	Corrosion resistance class (CRC)	Part no.	Type
	With through-hole	1.5 ... 10 bar	2 - Moderate corrosion stress	8098888	VABS-B14-90-FF14

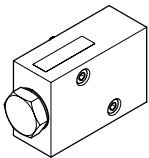
Exhaust plate VABF-B14-M3-...14					
	Type of mounting	Operating pressure	Corrosion resistance class (CRC)	Part no.	Type
	With through-hole	1.5 ... 10 bar	2 - Moderate corrosion stress	8099627	VABF-B14-M3-N14

Accessories

Exhaust plate VABF-B14-M3-...14

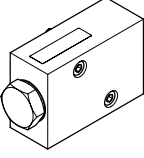
	Type of mounting	Operating pressure	Corrosion resistance class (CRC)	Part no.	Type
	With through-hole	1.5 ... 10 bar	2 - Moderate corrosion stress	8099350	VABF-B14-M3-G14

Throttle plate (single-acting) VABF-B14-F1B1P1-FF14

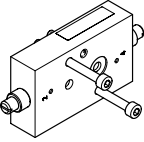
	Type of mounting	Operating pressure	Corrosion resistance class (CRC)	Part no.	Type
	With through-hole	1.5 ... 10 bar	2 - Moderate corrosion stress	8098885	VABF-B14-F1B1P1-FF14

Throttle plate (double-acting) VABF-B14-F1B1P2-FF14

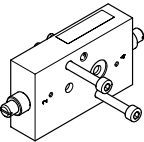
	Type of mounting	Operating pressure	Corrosion resistance class (CRC)	Part no.	Type
	With through-hole	1.5 ... 10 bar	2 - Moderate corrosion stress	8098887	VABF-B14-F1B1P2-FF14

Connector plate VABS-B14-T-F ... 14

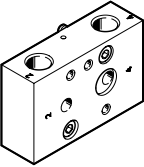
	Type of mounting	Operating pressure	Corrosion resistance class (CRC)	Part no.	Type
	With through-hole	1.5 ... 10 bar	2 - Moderate corrosion stress	8099628	VABS-B14-T-FN14
				8098884	VABS-B14-T-FG14

Push-in fitting QS

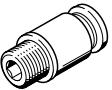
	Pneumatic connection 1	Pneumatic connection 2	Part no.	Type
	External thread G1/8	for pneumatic tubing outside diameter 4 mm	★ 186106	QS-G1/8-4-I
			★ 186095	QS-G1/8-4
		for pneumatic tubing outside diameter 6 mm	★ 186107	QS-G1/8-6-I
			★ 186096	QS-G1/8-6
		for pneumatic tubing outside diameter 8 mm	★ 186109	QS-G1/8-8-I
	★ 186098	QS-G1/8-8		
		for pneumatic tubing outside diameter 10 mm	★ 132999	QS-G1/8-10-I

Push-in fitting NPQE

	Pneumatic connection 1	Pneumatic connection 2	Part no.	Type
	External thread R1/8	for pneumatic tubing outside diameter 4 mm	8112913	NPQE-D-R18-Q4-P10

Accessories

Push-in fitting NPQE				
	Pneumatic connection 1	Pneumatic connection 2	Part no.	Type
	External thread R1/8	for pneumatic tubing outside diameter 6 mm	8112914	NPQE-D-R18-Q6-P10
		for pneumatic tubing outside diameter 8 mm	8112915	NPQE-D-R18-Q8-P10
		for pneumatic tubing outside diameter 10 mm	8112916	NPQE-D-R18-Q10-P10
		for pneumatic tubing outside diameter 12 mm	8112917	NPQE-D-R18-Q12-P10

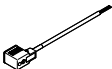
Connecting cable NEBV						
	Cable design	Nominal operating voltage DC	Cable length	Product weight	Part no.	Type
	2 x 0.75 mm ²	24 V	2.5 m	120 g	8032623	NEBV-C1SW2L-P-K-2.5-N-LE2-S9
			5 m	230 g	8032626	NEBV-C1SW2L-P-K-5-N-LE2-S9
			10 m	440 g	8032627	NEBV-C1SW2L-P-K-10-N-LE2-S9
	3 x 0.5 mm ²		2.5 m	125 g	8032628	NEBV-C1SW3-K-2.5-N-LE3-S9
			5 m	235 g	8032629	NEBV-C1SW3-K-5-N-LE3-S9

Silencer			
	Pneumatic connection	Part no.	Type
	G1/8	★ 1206622	AMTE-M-H-G18
		★ 2307	U-1/8
		534222	U-1/8-50
		★ 1205860	AMTE-M-LH-G18
		3670	U-1/8-I
		6841	U-1/8-B
		★ 161419	UC-1/8

Cover cap			
	Cover cap material	Part no.	Type
	POM	8049538	VAMC-B10-20-CH2-S