

Proportional-pressure regulator VPPM-NPT

FESTO



Characteristics

At a glance

Innovative:

- Multi-sensor control (cascade control)
- Diagnostics
- Choice of control characteristics
- Temperature-compensated
- High dynamic response
- High repetition accuracy
- Modular system processing

Flexible:

- Individual valves (inline valve)
- Various user interfaces: LED displays, LCD display, setting/selection buttons
- Choice of valves with different pressure ranges
- Pressure range can be modified at the valve
- Choice of different setpoint specifications: current input; voltage input

Operationally safe:

- Integrated pressure sensor with separate output
- Cable break monitoring
- Pressure is maintained if the controller fails

Easy to assemble:

- H-rail mounting
- Individually with mounting bracket
- QS fittings

Layout of a control loop (layout):

- The reference variable w (setpoint value e.g. 5 volts or 8 milliamperes) first acts on a comparator. The measuring equipment sends the value of the controlled variable x (actual value e.g. 3 bar) to the comparator as feedback variable r . The control element detects the control difference e and controls the final control element. The output of the final control element acts on the system. The control element thus attempts to compensate for the difference between the reference variable w and the controlled variable x by using the final control element.

Operating principle:

- This process runs continuously so changes in the reference variable are always detected. However, a system deviation will also occur if the reference variable is constant and the controlled variable changes. This happens when there is a change in the flow rate through the valve, caused by a switching operation, a cylinder movement or a load change. The disturbance variable z also causes a control difference, such as, for example, a pressure drop in the air supply. The disturbance variable z has an unintended effect on the controlled variable x . The controller always tries to re-adjust the controlled variable x to the reference variable w .

Multi-sensor control (cascade control) of the VPPM:

- Unlike conventional direct-acting control systems, in multi-sensor control several control loops are nested inside one another. The overall controlled system is thus divided into smaller sections that are easier to control for specific tasks.

Control precision:

- The principle of multi-sensor control means that the control accuracy and dynamic response is considerably better than with a single-acting controller.

Valve function

[3] 3-way proportional-pressure regulator, closed

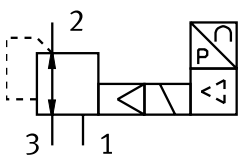

Characteristics

Ordering data - modular system

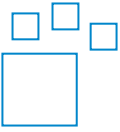

Configurable product

This product and all its product options can be ordered online via the configurator.

Diagrams

[Further information → vppm](#)



The diagrams shown in this document are also available online. These can be used to display precise values.

Type code

001	Series	
VPPM	Proportional pressure regulator, modular	
002	Nominal width [mm]	
6	6	
8	8	
12	12	
003	Directional control valve type	
L	In-line valve	
004	Mounting method	
	Standard	
005	Dynamic response	
L	Low	
006	Valve function	
1	3/2-way valve, normally closed	
007	Pneumatic connection	
N18	1/8 NPT	
N14	1/4 NPT	
N12	1/2 NPT	
008	Lower pressure value of control range	
0L	0 bar	

009	Upper pressure value of control range	
2H	2 bar	
6H	6 bar	
10H	10 bar	
010	Alternative lower pressure regulation range	
...L	0 ... 9 bar	
011	Alternative upper pressure regulation range	
...H	0.2 ... 10 bar	
012	Setpoint input for individual valves	
A4	4 ... 20 mA	
V1	0 ... 10 V	
013	Switching input/output	
N	NPN	
P	PNP	
014	Overall accuracy	
	2%	
S1	1 %	
015	Operator unit/interface	
	None	
C1	With LCD, variable pressure unit	

Datasheet

General technical data

Pneumatic connection, port 1	Sub-base						1/8 NPT			1/2 NPT	
Nominal size, supply	6 mm			8 mm			6 mm			12 mm	
Nominal size, exhaust	4.5 mm			7 mm			4.5 mm			12 mm	
Standard nominal flow rate (standardised to DIN 1343)	380 l/min	900 l/min	1,400 l/min	450 l/min	1,050 l/min	1,650 l/min	380 l/min	900 l/min	1,400 l/min	4,500 l/min	7,000 l/min
Valve function	3-way proportional pressure regulator										
Design	Piloted diaphragm regulator										
Sealing principle	Soft										
Type of actuation	Electric										
Type of piloting	Pilot actuated										
Type of reset	Mechanical spring										
Type of mounting	Either:, With through-hole, With accessories										
Mounting position	optional										
Product weight	400 g			560 g			400 g			2,050 g	

Electrical data

Pneumatic connection, port 1	Sub-base			1/8 NPT			1/2 NPT		
Electrical connection	Via sub-base			8-pin, M12, Plugs					
Operational voltage range DC	21.6 ... 26.4 V								
Residual ripple	10%								
Duty cycle	100%								
Max. electrical power consumption	7 W						12 W		
Setpoint value input	-								
Short circuit current rating	For all electrical connections								
Reverse polarity protection	For all electrical connections								
Degree of protection	IP65								
Signal range analogue input	-			0 - 10 V 4 - 20 mA					
Signal range analogue output	-			0 - 10 V 4 - 20 mA					

Materials

Material housing	Wrought aluminium alloy, Anodised	
Material membrane	-	

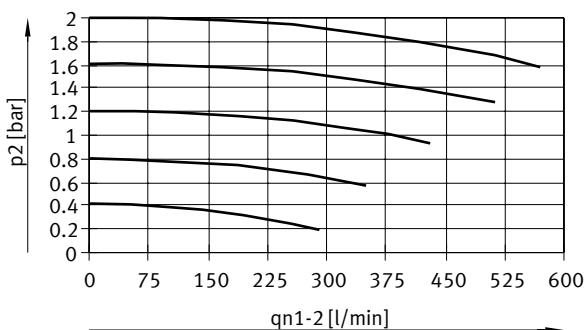
Flow rate q_n from 1 -> 2 as a function of excess output pressure p_2 , VPPM-6L/F-...-0L2H-... (2 bar)

Datasheet

Flow rate q_n from 1 -> 2 as a function of excess output pressure p_2 , VPPM-6L/F-...-0L6H-... (6 bar)

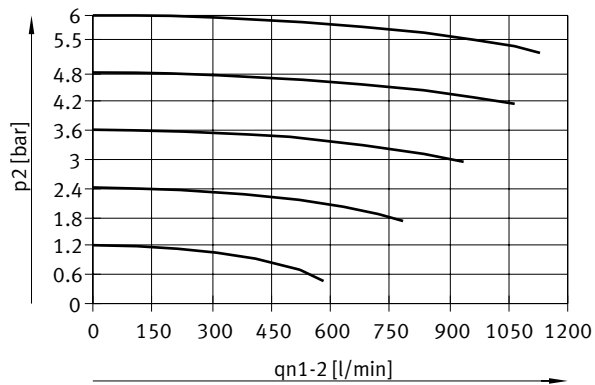

Flow rate q_n from 1 -> 2 as a function of excess output pressure p_2 , VPPM-6L/F-...-0L10H-... (10 bar)

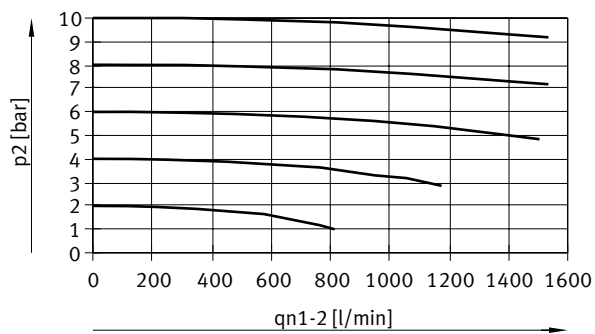

Flow rate q_n from 2 -> 3 as a function of excess output pressure p_2 , VPPM-6L/F-...-0L2H-... (2 bar)

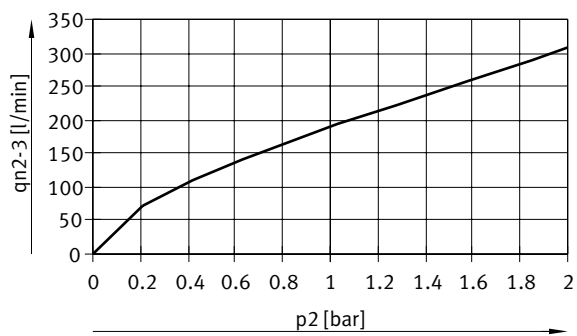

Datasheet

Flow rate q_{n2-3} from 2 -> 3 as a function of excess output pressure p_2 , VPPM-6L/F-...-0L6H-... (6 bar)

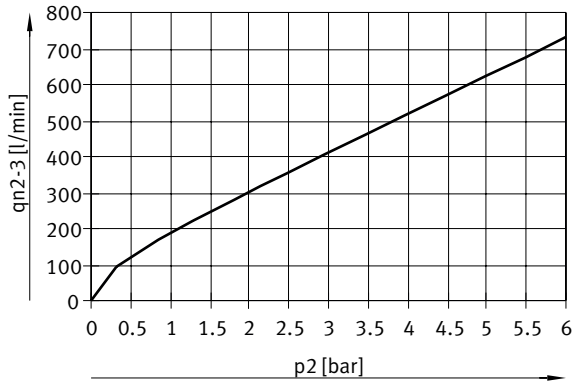

Flow rate q_n from 2 -> 3 as a function of excess output pressure p_2 , VPPM-6L/F-...-0L10H-... (10 bar)

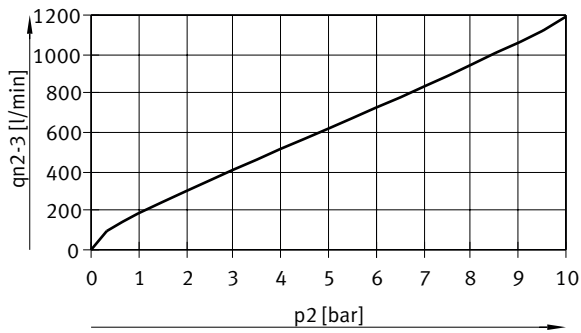

Flow rate q_n from 1 -> 2 as a function of excess output pressure p_2 , VPPM-8L/F-...-0L2H-... (2 bar)

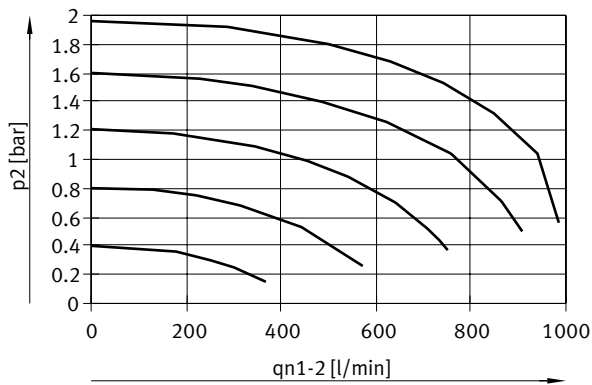

Datasheet

Flow rate q_n from 1 -> 2 as a function of excess output pressure p_2 , VPPM-8L/F-...-0L6H-... (6 bar)

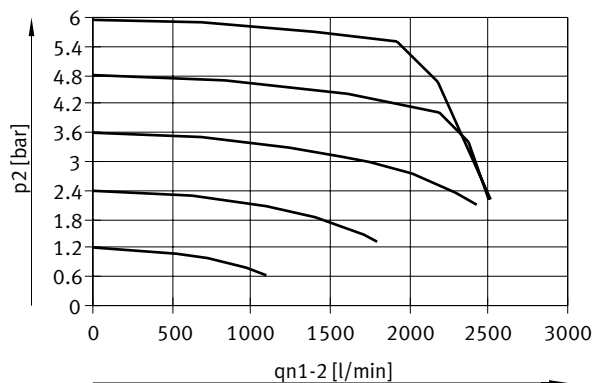

Flow rate q_n from 1 -> 2 as a function of excess output pressure p_2 , VPPM-8L/F-...-0L10H-... (10 bar)

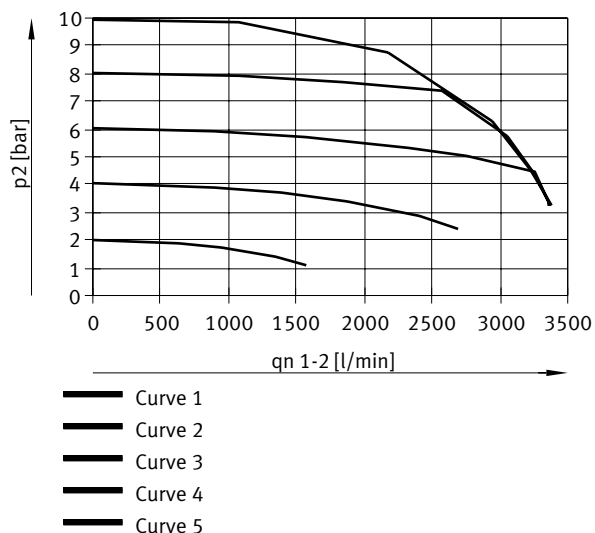

Flow rate q_n from 2 -> 3 as a function of excess output pressure p_2 , VPPM-8L/F-...-0L2H-... (2 bar)

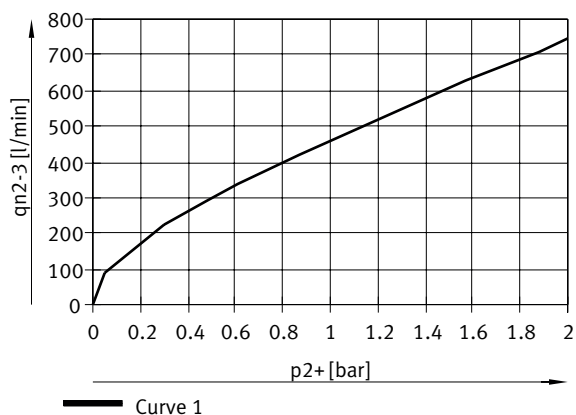

Datasheet

Flow rate q_{n2-3} from 2 -> 3 as a function of excess output pressure p_{2+} , VPPM-8L/F-...-0L6H-... (6 bar)

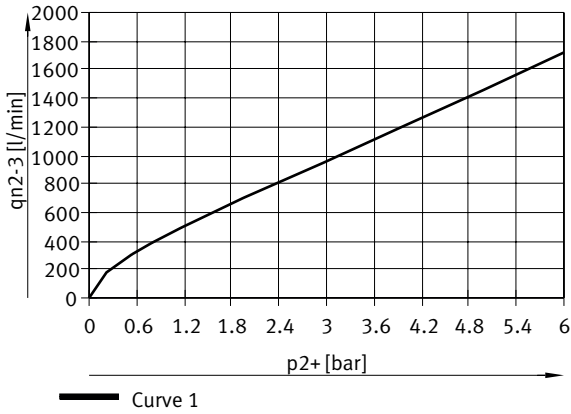

Flow rate q_{n2-3} from 2 -> 3 as a function of excess output pressure p_{2+} , VPPM-8L/F-...-0L10H-... (10 bar)



Flow rate q_n from 1 -> 2 as a function of excess output pressure p_2 , VPPM-8F/8TA-...-0L2H-... (2 bar)

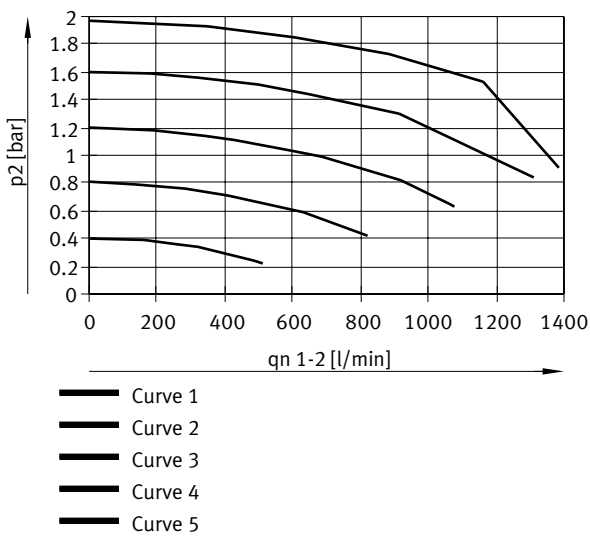

Datasheet

Flow rate q_n from 1 -> 2 as a function of excess output pressure p_2 , VPPM-8F/8TA-...-0L6H-... (6 bar)

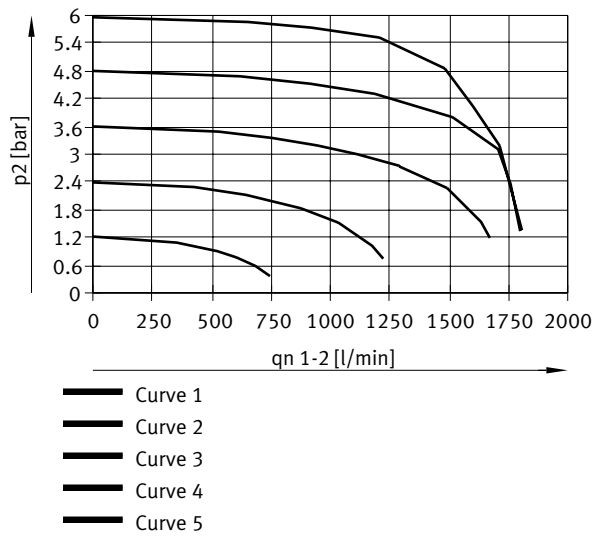

Flow rate q_n from 1 -> 2 as a function of excess output pressure p_2 , VPPM-8F/8TA-...-0L10H-... (10 bar)

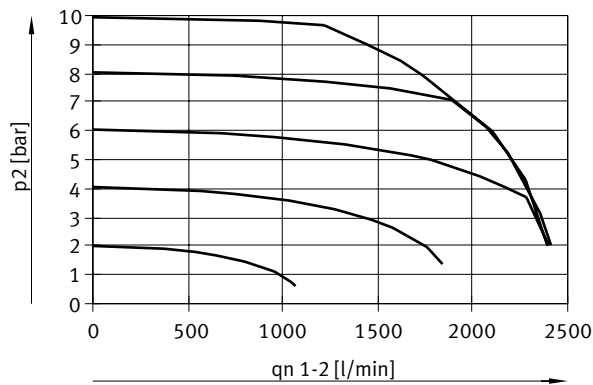

Flow rate q_n from 2 -> 3 as a function of excess output pressure p_2 , VPPM-8F/8TA-...-0L2H-... (2 bar)

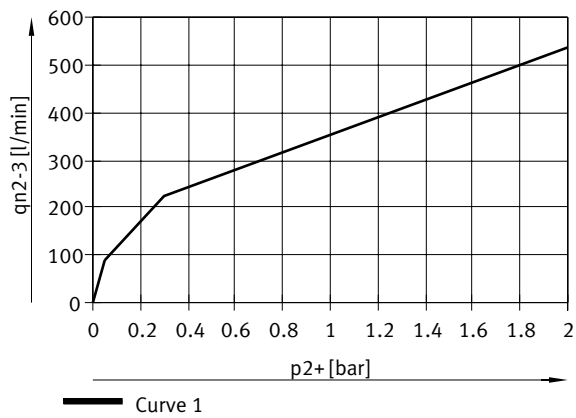

Datasheet

Flow rate q_{n2-3} from 2 -> 3 as a function of excess output pressure p_{2+} , VPPM-8F/8TA-...-0L6H-... (6 bar)

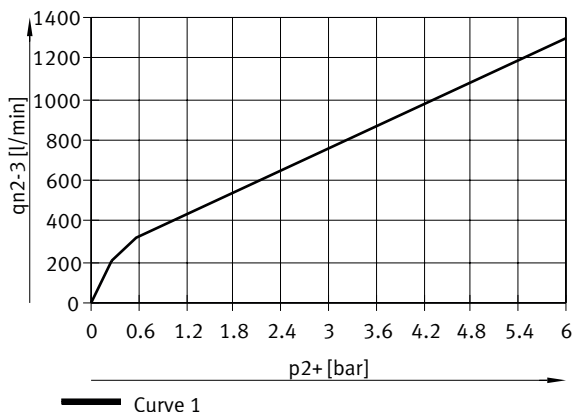

Flow rate q_{n2-3} from 2 -> 3 as a function of excess output pressure p_{2+} , VPPM-8F/8TA-...-0L10H-... (10 bar)

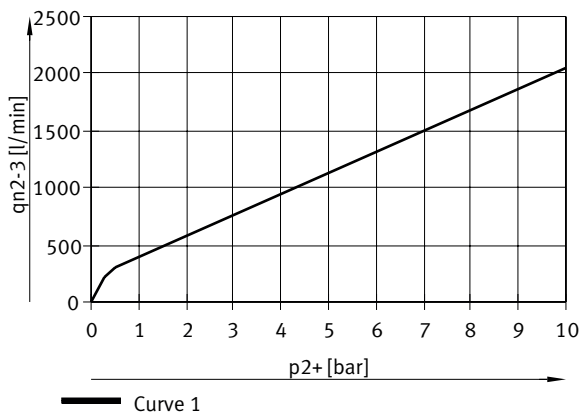

Flow rate q_{n1-2} from 1 -> 2 as a function of excess output pressure p_2 , VPPM-12L-...-0L2H-... (4 bar)

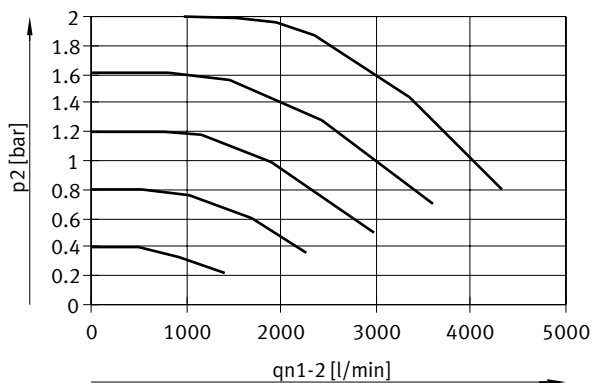

Datasheet

Flow rate q_n from 1 -> 2 as a function of excess output pressure p_2 , VPPM-12L-...-0L6H-... (8 bar)

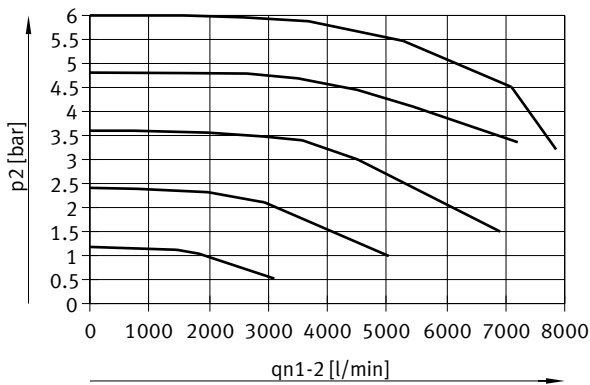

Flow rate q_n from 1 -> 2 as a function of excess output pressure p_2 , VPPM-12L-...-0L10H-... (11 bar)

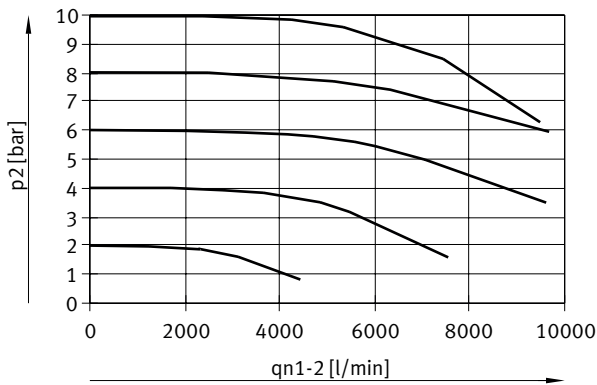

Flow rate q_n from 2 -> 3 as a function of excess output pressure p_2 , VPPM-12L-...-0L2H-... (4 bar)

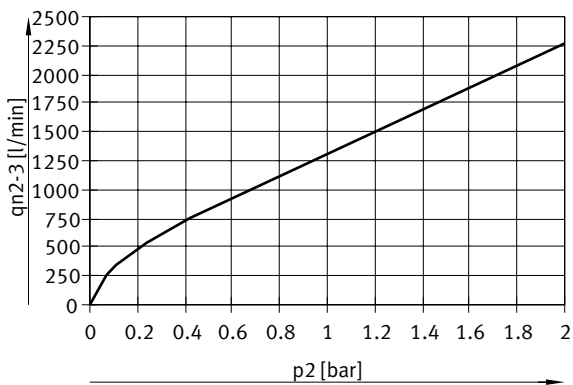

Datasheet

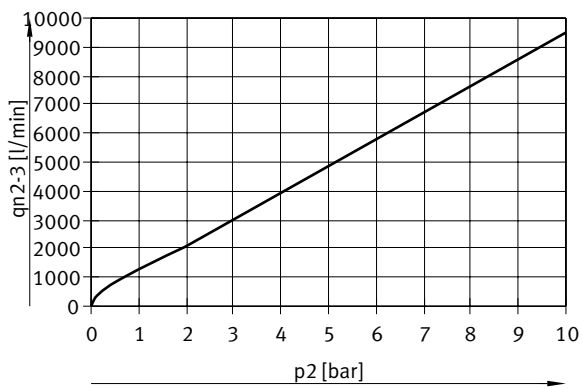
Flow rate q_{n2-3} from 2 -> 3 as a function of excess output pressure p_2 , VPPM-12L-...-0L6H-... (8 bar)Flow rate q_n from 2 -> 3 as a function of excess output pressure p_2 , VPPM-12L-...-0L10H-... (11 bar)

Dimensions

Dimensions – VPPM-6L, with LCD

Download CAD data → www.festo.com

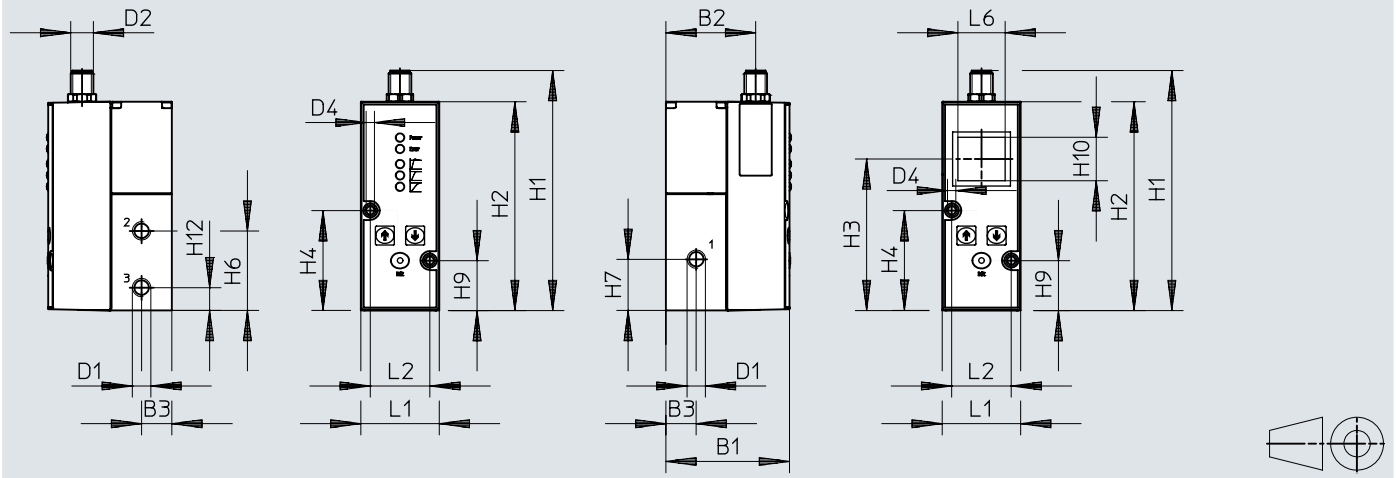

[1] Socket head screw M4x65

	B1	B2	B3	D1	D2	D4 ∅	H1	H2	H3	H4	H6	H7	H9	H10	H12
VPPM-6L	65.5	47.5	16	1/8 NPT	M12x1	4.4	126.9	110.4	80.1	52.8	42	27	26.3	23	12
	L1			L2			L6								
VPPM-6L	41.5			31.5			25								

Dimensions

Dimensions – VPPM-8L, with LCD

Download CAD data → www.festo.com

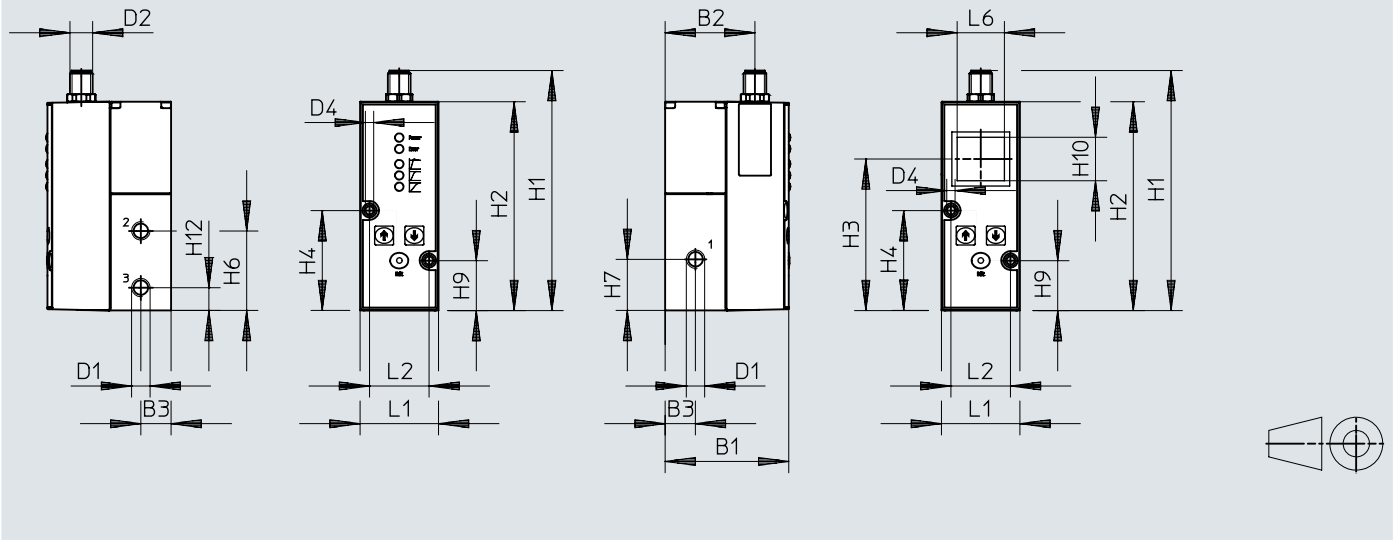

	B1	B2	B3	D1	D2	H1	H2	H3	H4	H6	H7	H9	H10	H12
VPPM-8L	77.4	59.5	22	1/4 NPT	M12	126.9	110.4	80	52.8	42	27	26.3	23	12
	L1			L2			L6							
VPPM-8L	47			31.5			25							

Dimensions

Dimensions – VPPM-6TA, sub-base valve

Download CAD data → www.festo.com

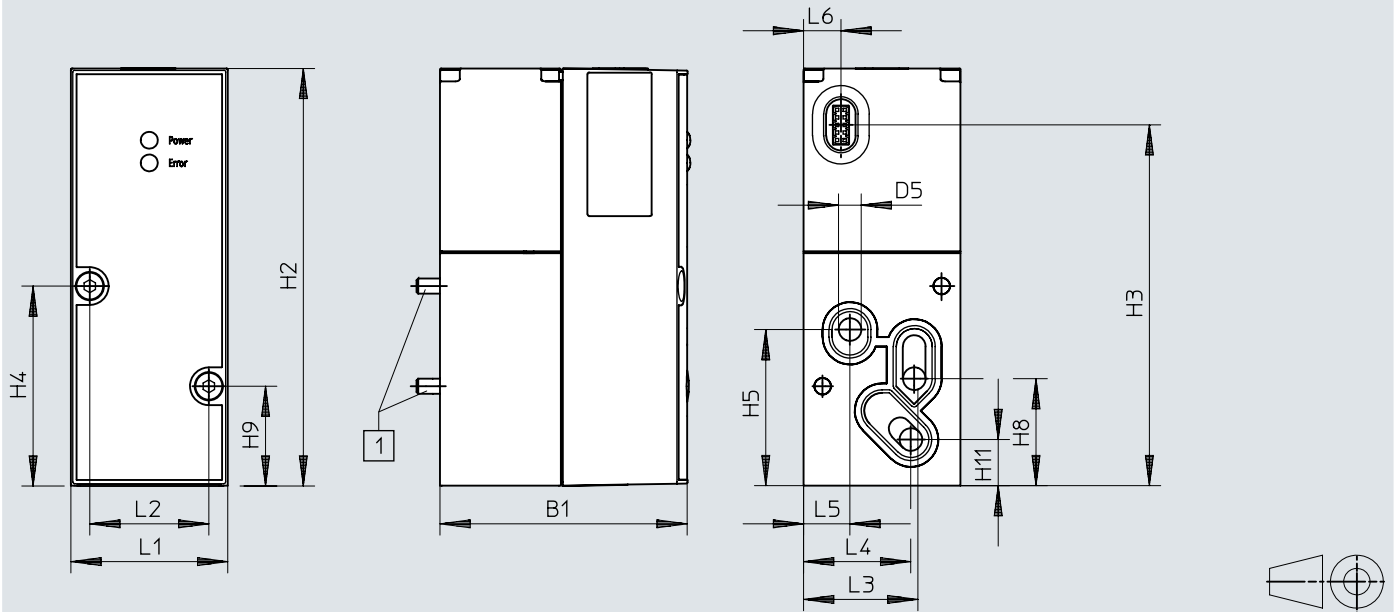

[1] Socket head screw M4x55

	B1	D5 ∅	H2	H3	H4	H5	H8	H9	H11
VPPM-6TA	55.1	6	110.4	95.5	52.8	41.3	28.3	26.3	12.2

	L1	L2	L3	L4	L5	L6
VPPM-6TA	41.5	31.5	30.3	28.4	12.3	9.9

Dimensions

Dimensions – VPPM-8TA, sub-base valve with LCD

Download CAD data → www.festo.com

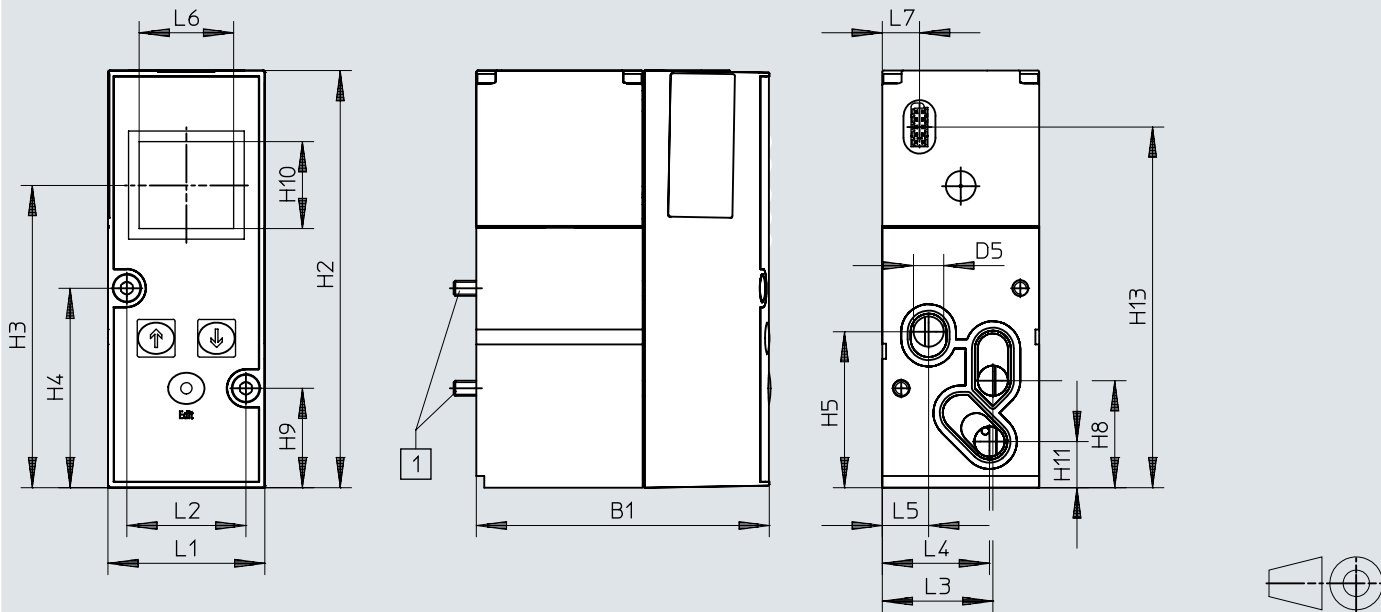

[1] Socket head screw M4x77

	B1	D5 ∅	H2	H3	H4	H5	H8	H9	H10	H11	H13
VPPM-8TA	77.4	8	110.4	80	52.8	41.3	28.3	26.3	23	12.2	95.5

	L1	L2	L3	L4	L5	L6	L7
VPPM-8TA	41.5	31.5	29.3	28.4	12.3	25	9.9

Dimensions

Dimensions – VPPM-12L, with LCD

Download CAD data → www.festo.com

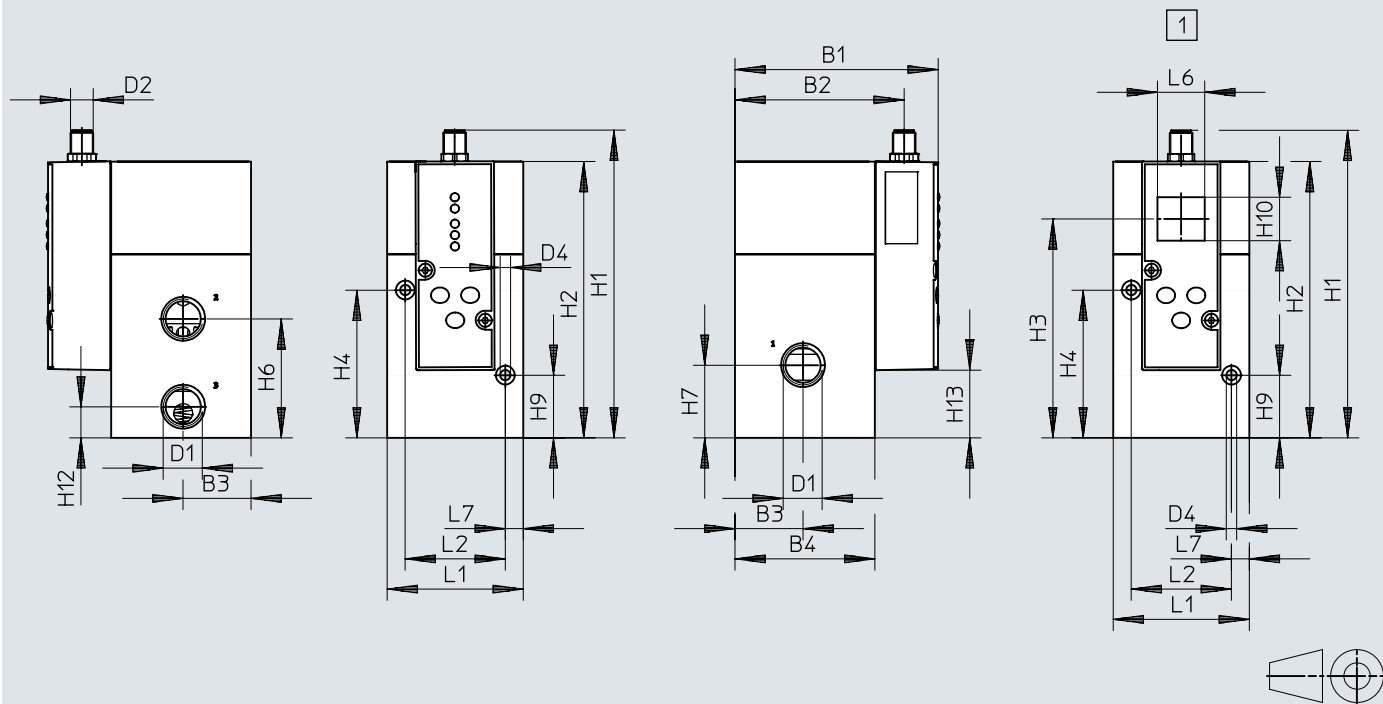

[1] With LCD

	B1	B2	B3	B4	D1	D2	D4 ∅	H1	H2	H3	H4	H6	H7	H9	H10	H12	H13
VPPM-12L	107.4	89.5	36	74	1/2 NPT	M12x1	5.5	162.8	146.3	116	78.2	63	38.5	33.2	23	16.5	35.9
	L1			L2			L6			L7							
VPPM-12L	72			53			25			9.5							

Dimensions

Dimensions – Bracket VAME-P1-A

Download CAD data → www.festo.com

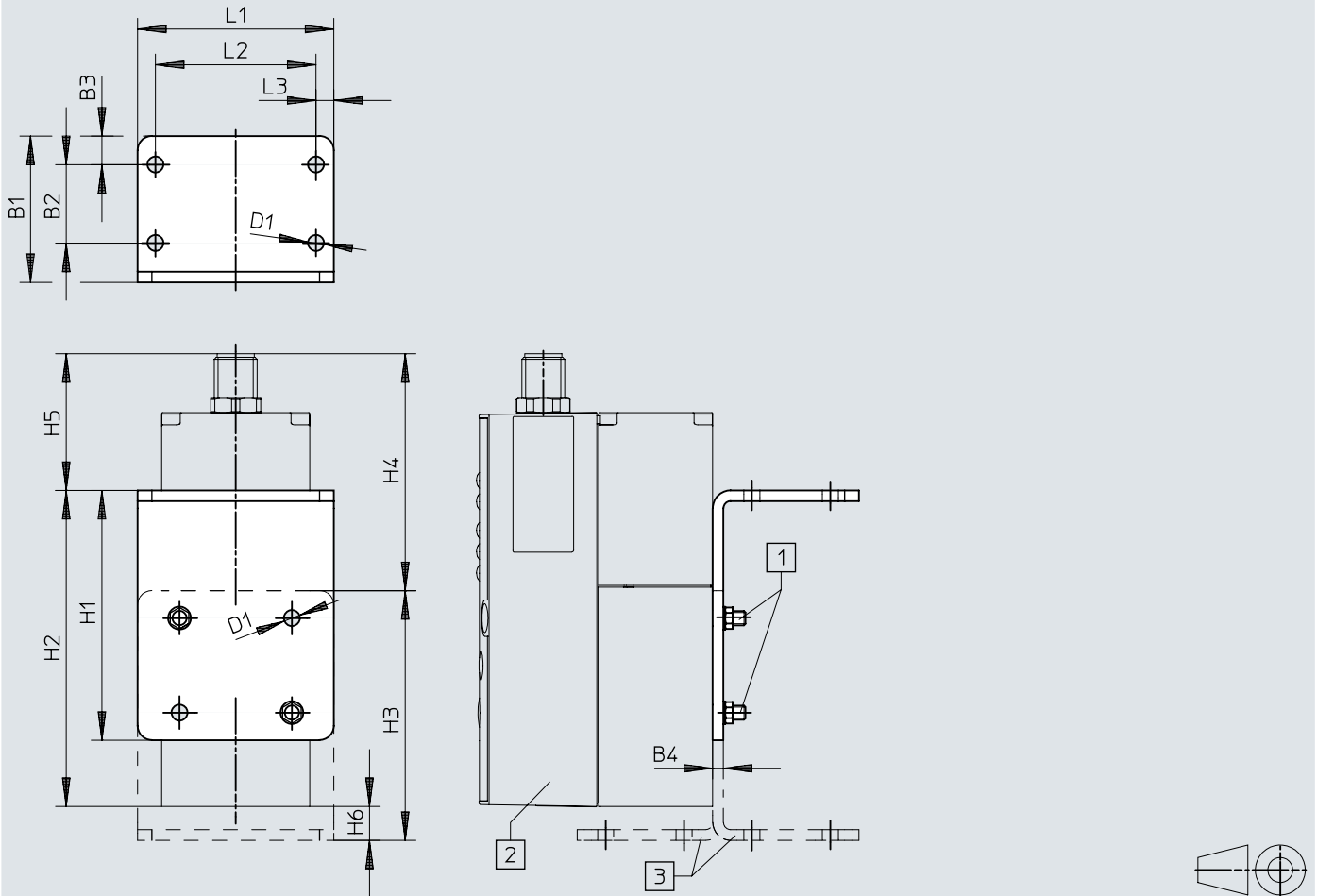

- [1] Socket head screw M4
- [2] Proportional-pressure regulator VPPM
- [3] Bracket can be reversed if required

	B1	B2	B3	B4	D1 ∅	H1	H2	H3	H4	H5	H6	L1	L2	L3
VAME-P1-A	41	22	8	3	4,5	70	88,6	70	66,4	38,3	9,5	55	45	5

Dimensions

Dimensions – H-rail mounting VAME-P1-T

Download CAD data → www.festo.com

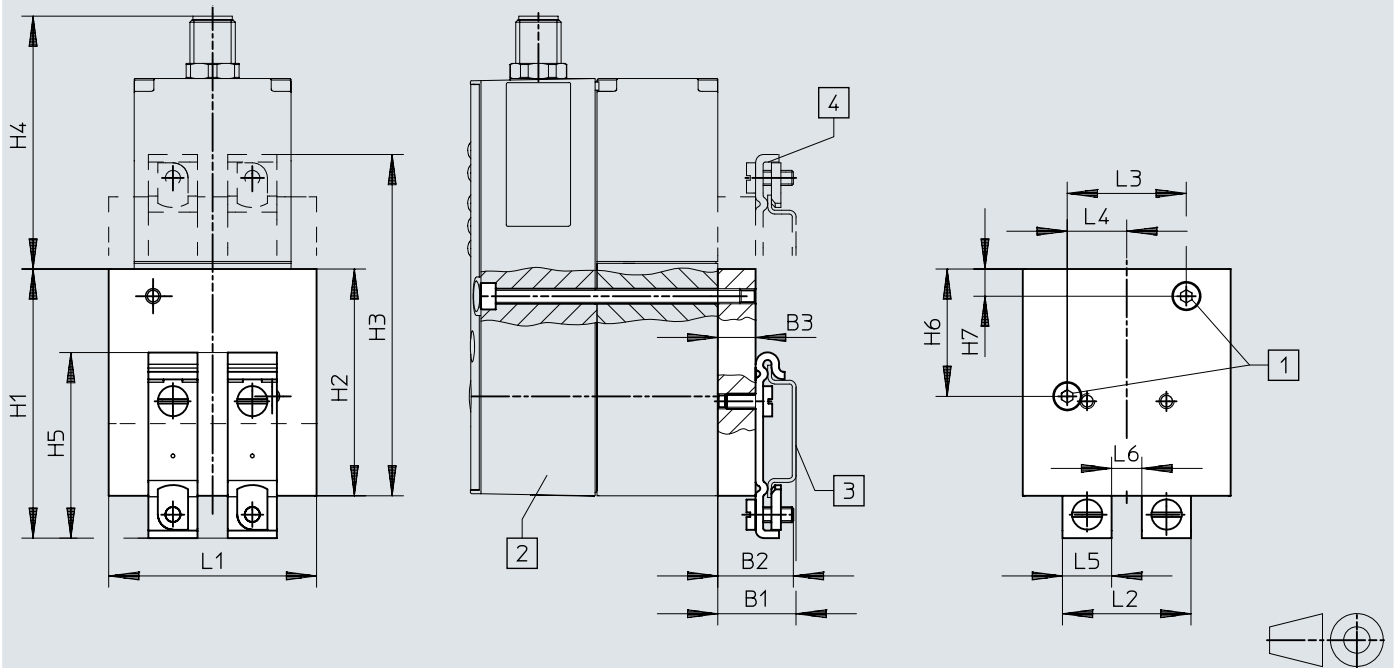

- [1] Socket head screw M4
- [2] Proportional-pressure regulator VPPM
- [3] H-rail NRH
- [4] H-rail mounting can be rotated 180° if required

	B1	B2	B3	H1	H2	H3	H4	H5	H6	H7	L1	L2	L3	L4	L5	L6
VAME-P1-T	20,7	20	10	71,2	60	90,3	66,9	49,1	33,7	7,2	55	34	31,5	15,75	13	8

Dimensions

Dimensions – Connecting cable NEBV-M12G8-KD-3-M12G4

Download CAD data → www.festo.com

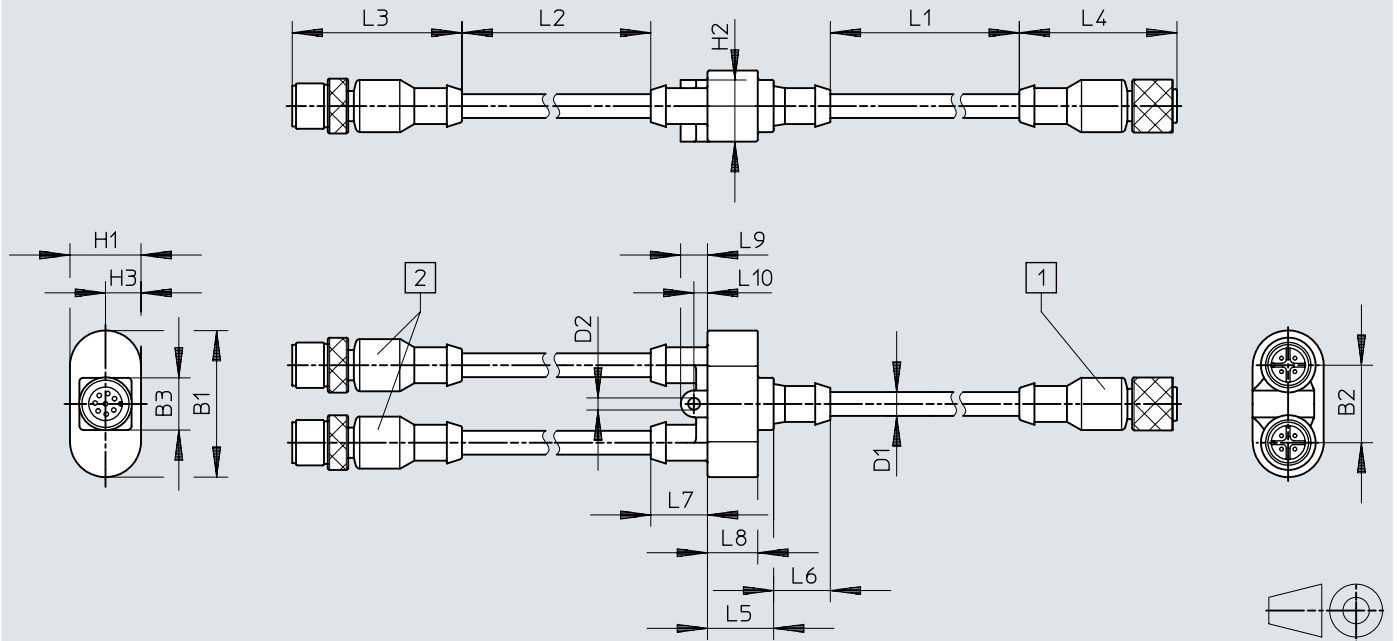

- [1] Straight socket, 8-pin on VPPM
- [2] Straight plug, 4-pin on CPX modules

	B1	B2	B3	D1	D2	H1	H2	H2	L1	L2	L3	L4	L5	L6	L7	L8	L9	L10
NEBV-M12G8	38,8	20,5	13,8	6,3	3,2	18,8	16,3	9,4	2500	500	44,9	41,7	17,5	15	15	13,3	7,1	3,6

Dimensions

Dimensions – Connecting cable NEBV-M12G8-K-5-M12G4

Download CAD data → www.festo.com

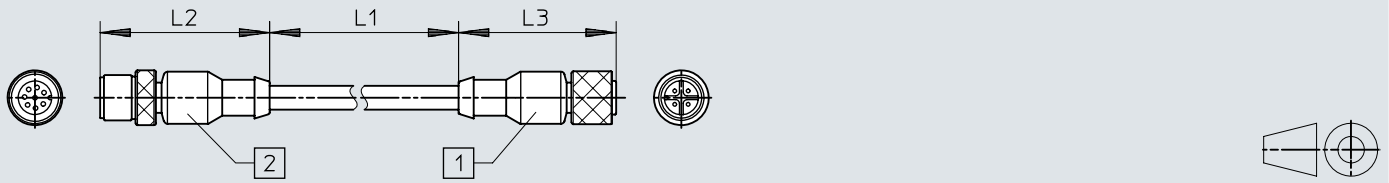

- [1] Straight plug, M12 4-pin on CPX module
- [2] Straight socket, M12 8-pin on VPPM

	L1	L2	L3
NEBV-M12G8-K-2-M12G4	2000	44,9	41,7
NEBV-M12G8-K-5-M12G4	5000	44,9	41,7

Ordering data

VPPM_NPT						
Signal range analogue input	Signal range analogue output	Total accuracy	Pneumatic connection, port 1	Pressure regulation range	Part no.	Type
0 - 10 V	0 - 10 V	1.25%FS	1/8 NPT	0.006 ... 0.6 MPa	558349	VPPM-6L-L-1-N18-0L6H-V1N-C1
					542212	VPPM-6L-L-1-N18-0L6H-V1N
				558343	VPPM-6L-L-1-N18-0L6H-V1P-C1	
				558348	VPPM-6L-L-1-N18-0L10H-V1N-S1C1	
			558341	VPPM-6L-L-1-N18-0L10H-V1P-S1C1		
			1/2 NPT	0.006 ... 0.6 MPa	576680	VPPM-12L-L-1-N12-0L6H-V1P-S1C1
				0.01 ... 1 MPa	576681	VPPM-12L-L-1-N12-0L10H-V1P-S1C1
			4 - 20 mA	4 - 20 mA	1.25%FS	1/8 NPT
0.006 ... 0.6 MPa	558344	VPPM-6L-L-1-N18-0L6H-A4P-C1				
0.01 ... 1 MPa	542216	VPPM-6L-L-1-N18-0L10H-A4N				
1/2 NPT	0.006 ... 0.6 MPa	558342				VPPM-6L-L-1-N18-0L10H-A4P-S1C1
	0.006 ... 0.6 MPa	576682				VPPM-12L-L-1-N12-0L6H-A4P-S1C1
	0.01 ... 1 MPa	576683				VPPM-12L-L-1-N12-0L10H-A4P-S1C1

VPPM-NPT, for valve terminal				
Total accuracy	Pneumatic connection, port 1	Pressure regulation range	Part no.	Type
1.25%FS	Sub-base	0.002 ... 0.2 MPa	572407	VPPM-8TA-L-1-F-0L2H-S1C1
			542217	VPPM-6TA-L-1-F-0L2H-S1
			542220	VPPM-6TA-L-1-F-0L2H
		0.006 ... 0.6 MPa	572410	VPPM-8TA-L-1-F-0L2H-C1
			542218	VPPM-6TA-L-1-F-0L6H-S1
			572408	VPPM-8TA-L-1-F-0L6H-S1C1
			572411	VPPM-8TA-L-1-F-0L6H-C1
		0.01 ... 1 MPa	542221	VPPM-6TA-L-1-F-0L6H
			572412	VPPM-8TA-L-1-F-0L10H-C1
			542219	VPPM-6TA-L-1-F-0L10H-S1
			542222	VPPM-6TA-L-1-F-0L10H
			572409	VPPM-8TA-L-1-F-0L10H-S1C1

Modular product system			
	Nominal size, supply	Part no.	Type
	6 mm	546953	VPPM-6-NPT
	8 mm	546954	VPPM-8-NPT
	12 mm	546956	VPPM-12-NPT

Peripherals

Individual valve VPPM-6L...

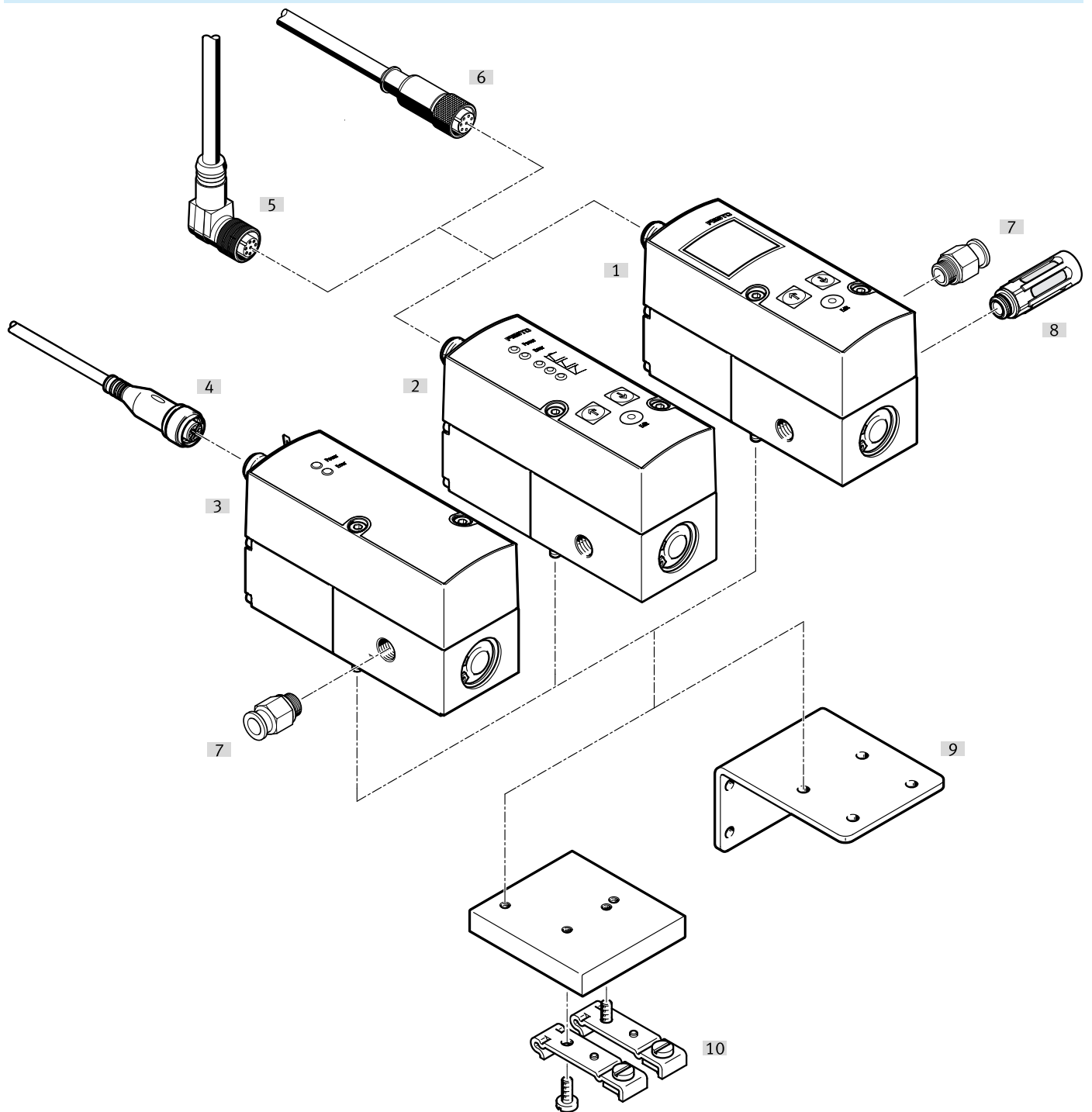

Accessories			→ Page/Internet
Type/order code	Description		
[1]	Proportional-pressure regulator with LCD	Operator unit with LCD	–
[2]	Proportional-pressure regulator with LED	Operator unit with LED	–
[5]	Angled plug socket with cable	–	27
[6]	Plug socket with cable, straight	–	27
[7]	Push-in fitting	For connecting tubing with standard O.D.	qs
[8]	Silencer	For mounting in exhaust ports	u
[9]	Bracket	For mounting the valve	27
[10]	H-rail mounting	For mounting on an H-rail	27

Peripherals

Individual valve VPPM-12L...

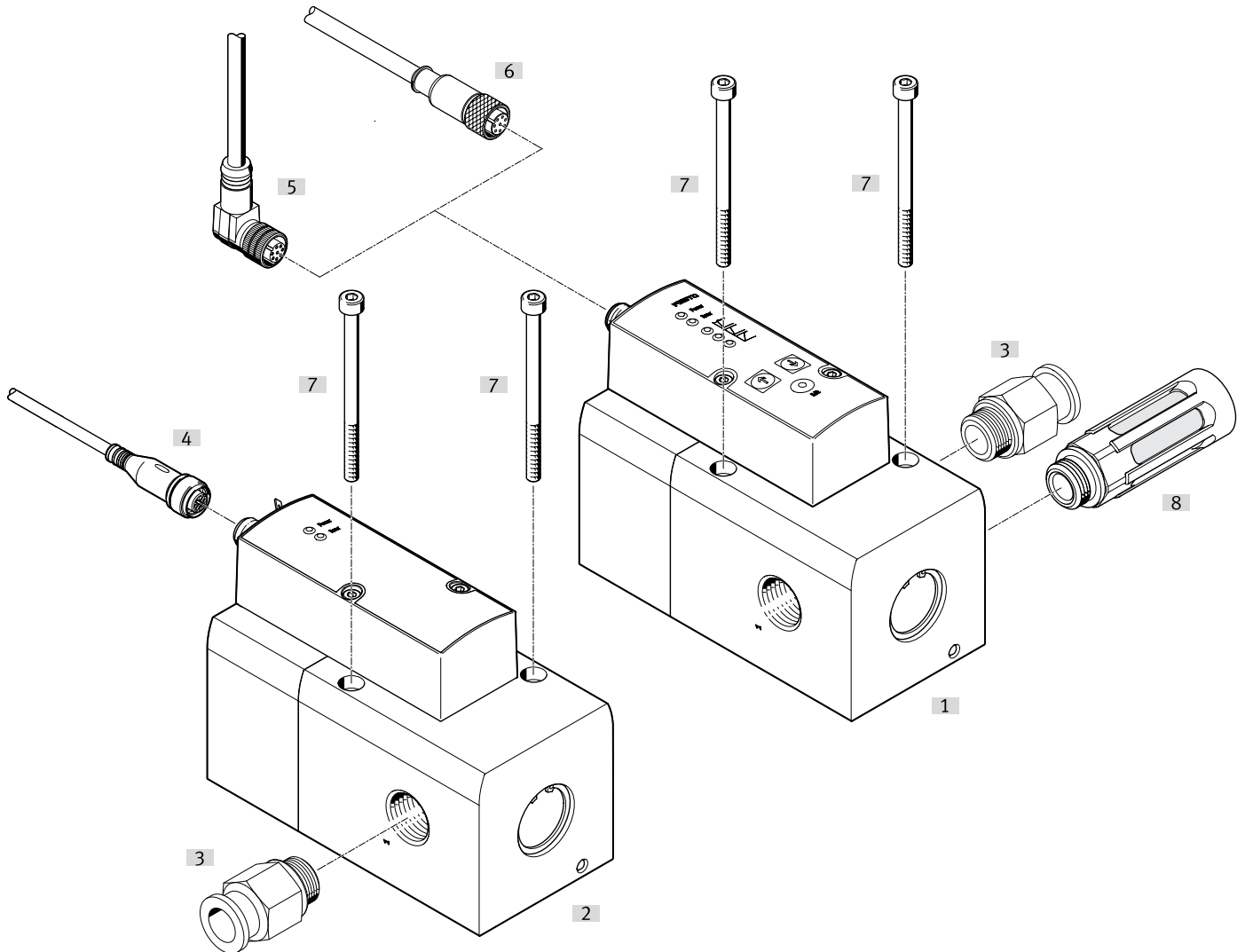

Accessories			→ Page/Internet
Type/order code	Description		
[1] Proportional-pressure regulator with LED or LCD	Operator unit with LED or LCD	-	-
[3] Push-in fitting	For connecting tubing with standard O.D.	qs	
[5] Angled plug socket with cable	-	27	
[6] Plug socket with cable, straight	-	27	
[7] Retaining screws	-	-	
[8] Silencer	For mounting in exhaust ports	u	

Peripherals

VPPM-6TA..., VPPM-8TA... for valve terminal MPA-S

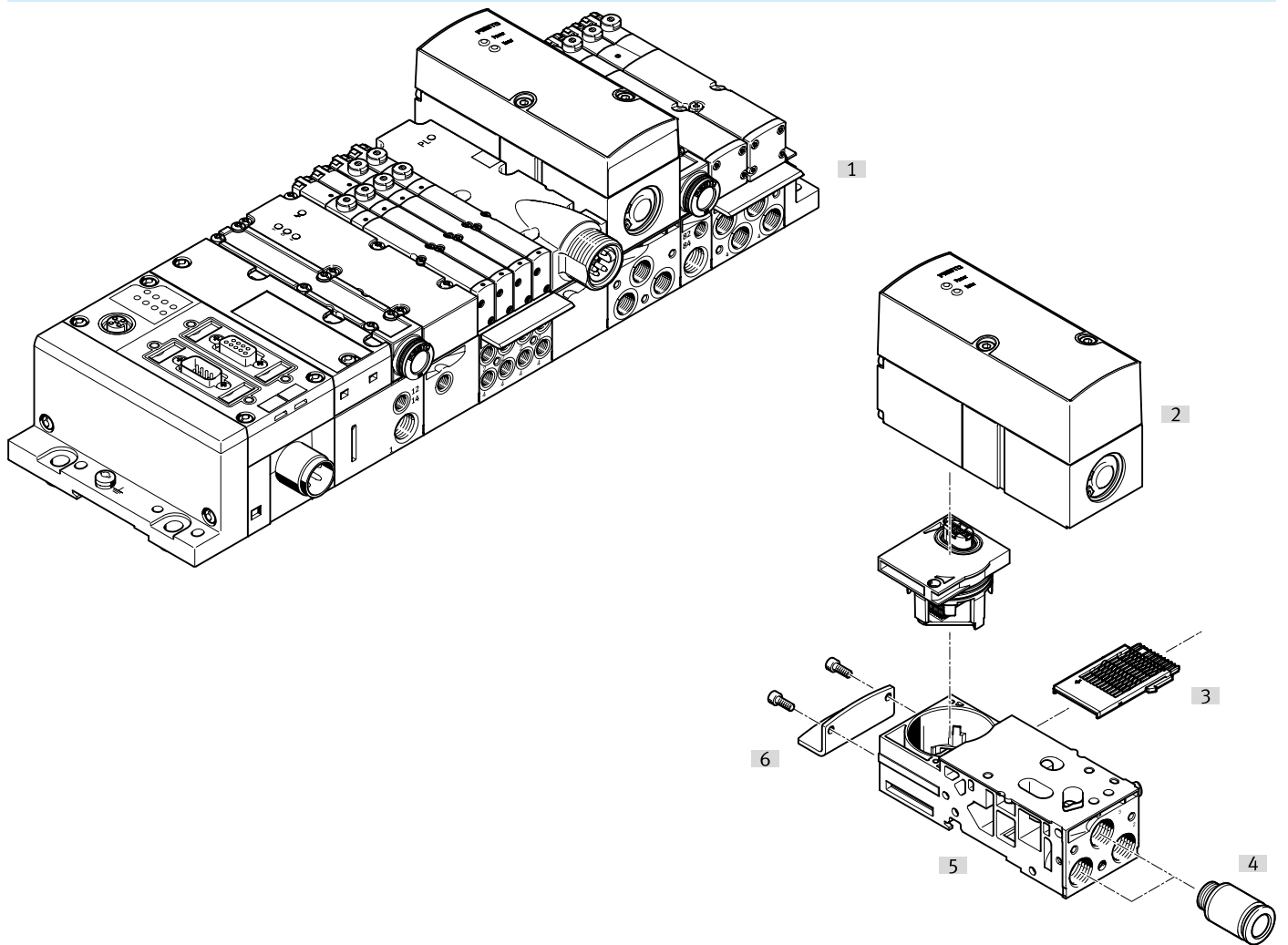

Accessories		→ Page/Internet
Type/order code	Description	
[1] Valve terminal MPA-S	With fieldbus connection and VPPM	mpas
[2] Proportional pressure regulator	For valve terminal MPA-S	mpas
[3] Electrical interlinking module	For the sub-base of the proportional-pressure regulator	mpas
[4] Sub-base	Without electrical linking module or electrical module	mpas
[5] Push-in fitting	–	qs
[6] Mounting	–	mpas

Accessories

Bracket				
	Product weight	Corrosion resistance class CRC ¹⁾	Part no.	Type
	71 g	1 - Low corrosion stress	542251	VAME-P1-A

1) More information www.festo.com/x/topic/crc

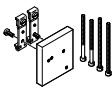
H-rail mounting				
	Product weight	Corrosion resistance class CRC ¹⁾	Part no.	Type
	150 g	1 - Low corrosion stress	542255	VAME-P1-T

1) More information www.festo.com/x/topic/crc

Connecting cable, straight socket							
	Electrical connection 1, connection type	Electrical connection 1, cable outlet	Electrical connection 1, number of connections/cores	Electrical connection 1, connector system	Cable length	Part no.	Type
	Socket	Straight	8	M12x1, A-coded to EN 61076-2-101	2 m	525616	SIM-M12-8GD-2-PU
5 m					525618	SIM-M12-8GD-5-PU	
10 m					570008	SIM-M12-8GD-10-PU	

Connecting cable, angled socket							
	Electrical connection 1, connection type	Electrical connection 1, cable outlet	Electrical connection 1, number of connections/cores	Electrical connection 1, connector system	Cable length	Part no.	Type
	Socket	Angled	8	M12x1, A-coded to EN 61076-2-101	2 m	542256	NEBU-M12W8-K-2-N-LE8
5 m					542257	NEBU-M12W8-K-5-N-LE8	
10 m					570007	NEBU-M12W8-K-10-N-LE8	

Connecting cable, one straight socket and one straight plug							
	Electrical connection 1, connection type	Electrical connection 1, cable outlet	Electrical connection 1, number of connections/cores	Electrical connection 1, connector system	Cable length	Part no.	Type
	Socket	Straight	8	M12x1, A-coded to EN 61076-2-101	2 m	553575	NEBV-M12G8-K-2-M12G4
5 m					553576	NEBV-M12G8-K-5-M12G4	

Connecting cable, one straight socket and two straight plugs							
	Electrical connection 1, connection type	Electrical connection 1, cable outlet	Electrical connection 1, number of connections/cores	Electrical connection 1, connector system	Part no.	Type	
	Socket	Straight	8	M12x1, A-coded to EN 61076-2-101	547888	NEBV-M12G8-KD-3-M12G4	