

Branching module MS6-FRM

FESTO



Characteristics

At a glance

- Grid dimension: 62 mm
- Outlet at top and bottom
- Support for additional modules
- Optionally with integrated non-return function and pressure switch
- Can be used as an intermediate distributor for varying air qualities
- Optional pressure sensor

Product segmentation



Festo Core Range

Solves the majority of your automation tasks

With the Festo Core Range, we have selected the most important products and functions from our broad product catalogue, and added the quickest delivery. The Core Range offers you the best value with the expected high Festo quality.

- Quickest delivery, worldwide – wherever, whenever
- Expected high Festo quality
- Easy and fast to select

Ordering data - modular system

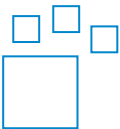

Configurable product

This product and all its product options can be ordered online via the configurator.

Function

Air distributor with 4 connections

Pneumatic connection

Depending on the size, different connection types can be selected:

- Individual fittings that are fastened via a female thread
- Connecting plates with female thread

Additional function

None

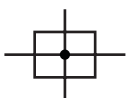

With integrated non-return function

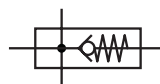

prevents backflow, e.g. of lubricated compressed air

Pressure gauge alternatives

Two pressure gauge connections for variable installation

Alternative pressure gauge scale

The scaling of the built-in pressure gauge can be selected. The unit options available are [MPa], [bar] / [psi].

Pressure switch

Optionally available with different pressure switches.

Characteristics

EU certification

Optional device variant EX4 for use in potentially explosive areas of zones 1, 2, 21 and 22

UL certification

Optional device variant UL1, which meets the safety requirements for the Canadian and US markets.

Flow direction

Available with flow in the opposite direction.

Type code

001 Series	
MS6	MS-series, size 6
002 Size	
6	Grid dimension 62 mm
003 Function	
FRM	Branching module
004 Pneumatic connection	
1/4	Female thread G1/4
3/8	Female thread G3/8
1/2	Female thread G1/2
AGB	Sub-base G1/4
AGC	Sub-base G3/8
AGD	Sub-base G1/2
AGE	Sub-base G3/4
005 Additional function	
	None
I	With integrated non-return function
006 Pressure gauge alternatives	
	None
A4	Adapter for EN pressure gauge 1/4, without pressure gauge
A8	Adapter for EN pressure gauge 1/8, without pressure gauge
AD7	Pressure sensor with switching display, M8 plug, threshold value comparator, PNP, N/O
AD8	Pressure sensor with switching display, M8 plug, threshold value comparator, PNP, N/C
AD9	Pressure sensor with switching display, M8 plug, window comparator, PNP, N/O
AD10	Pressure sensor with operational status indicator, M8 plug, window comparator, PNP, N/C
AD11	Pressure sensor with LCD display, M12 plug, 4-pin, IO-Link®, PNP, NPN, 0...10 V, 1...5 V, 4...20 mA
AD12	Pressure sensor with LCD display, M8 plug, 4-pin, IO-Link®, PNP, NPN, 0...10 V, 1...5 V, 4...20 mA
AG	MS pressure gauge
RG	Integrated pressure gauge, red/green scale

007 Alternative pressure gauge scale	
	MS pressure gauge
PSI	psi
MPA	MPa
008 Pressure switch	
	None
X	Pressure switch PEV with display, plug socket, EN 175301, type A, cube
Y	Pressure switch PEV without display, plug socket, EN 175301, type A, cube
M12	Pressure switch PEV without display, plug socket, round, M12, 4-pin
009 Type of mounting	
	Without mounting bracket
WP	Mounting bracket basic design
WPM	Mounting bracket for hooking in service unit components
WB	Mounting centrally at rear (wall mounting top and bottom), connecting plates not required
010 EU certification	
	None
EX4	II 2GD
011 UL certification	
	None
UL1	cULus ordinary location for Canada and USA
012 Flow direction	
	Flow direction from left to right
Z	Flow direction from right to left
013 Special material properties	
	None
F1A	Recommended for production plants for manufacturing lithium-ion batteries, F1A

Datasheet

General technical data

Pneumatic connection, port 1	G1/4, G3/8, G1/2
Pneumatic connection, port 2	G1/4, G3/8, G1/2
Pneumatic connection, port 3	G1/2
Pneumatic connection, port 4	G1/2
Design	Branching module, With non-return function
Mounting position	optional

Standard nominal flow rate

Pneumatic connection, port 1	G1/4, G3/8, G1/2
Standard nominal flow rate in main flow direction 1->2	3,200 ... 14,700 l/min
Standard nominal flow rate, outlet upwards	2,700 ... 6,000 l/min
Standard nominal flow rate, outlet downwards	2,800 ... 6,400 l/min

Electrical data

Operational voltage range AC ¹⁾	0 ... 250 V
Operational voltage range DC ²⁾	0 ... 125 V

1) Only in combination with pressure switch

2) Only in combination with pressure switch

Operating and environmental conditions

Operating pressure	0 ... 20 bar
Operating medium	Compressed air to ISO 8573-1:2010 [7:4:4], Inert gases
Note on operating and pilot medium	Lubricated operation possible (in which case lubricated operation will always be required)
Ambient temperature	-10 ... 60°C
Media temperature	-10 ... 60°C
Storage temperature	-10 ... 60°C
Corrosion resistance class CRC ¹⁾	2 - Moderate corrosion stress
Suitable for use with food ²⁾	See supplementary material information
Approval ³⁾	c UL us - Recognized (OL)
Instructions on use	Foreign particles can adhere to the product or form during installation. Depending on the application, it may be necessary to purge the product with clean compressed air, to clean it after installation and operate it with ducted exhaust air.

1) Corrosion resistance class CRC 2 to Festo standard FN 940070.

Moderate corrosion stress. Indoor applications in which condensation can occur. External visible parts with primarily decorative surface requirements that are in direct contact with a normal industrial environment.

2) More information www.festo.com/catalogue/ms-fm → Support/Downloads.

3) More information www.festo.com/catalogue/ms-fm → Support/Downloads.

ATEX

ATEX category gas	II 2G
Explosion ignition protection type for gas	Ex h IIC T6 Gb X
ATEX category dust	II 2D
Explosion ignition protection type for dust	Ex h IIIC T60°C Db X
Explosion ambient temperature	-10°C ≤ Ta ≤ +60°C
CE mark (see declaration of conformity) ¹⁾	To EU Explosion Protection Directive (ATEX)

1) More information www.festo.com/sp/Certificates.

Materials

Material housing	Die-cast aluminium
Note on materials	RoHS-compliant
LABS (PWIS) conformity	VDMA24364-B1/B2-L

Datasheet

Additional material properties – products for battery production (F1A)

Suitability for the production of Li-ion batteries	Metals with more than 1% by mass of copper, zinc or nickel by mass are excluded from use. Exceptions are nickel in steel, chemically nickel-plated surfaces, printed circuit boards, cables, electrical plug connectors and coils, Metals with more than 1% by mass of copper, zinc or nickel are excluded from use. Exceptions are nickel in steel, chemically nickel-plated surfaces, printed circuit boards, cables, electrical plug connectors and coils
--	--

Dimensions

Dimensions – Basic type with female thread, with cover plate

Download CAD data → www.festo.com

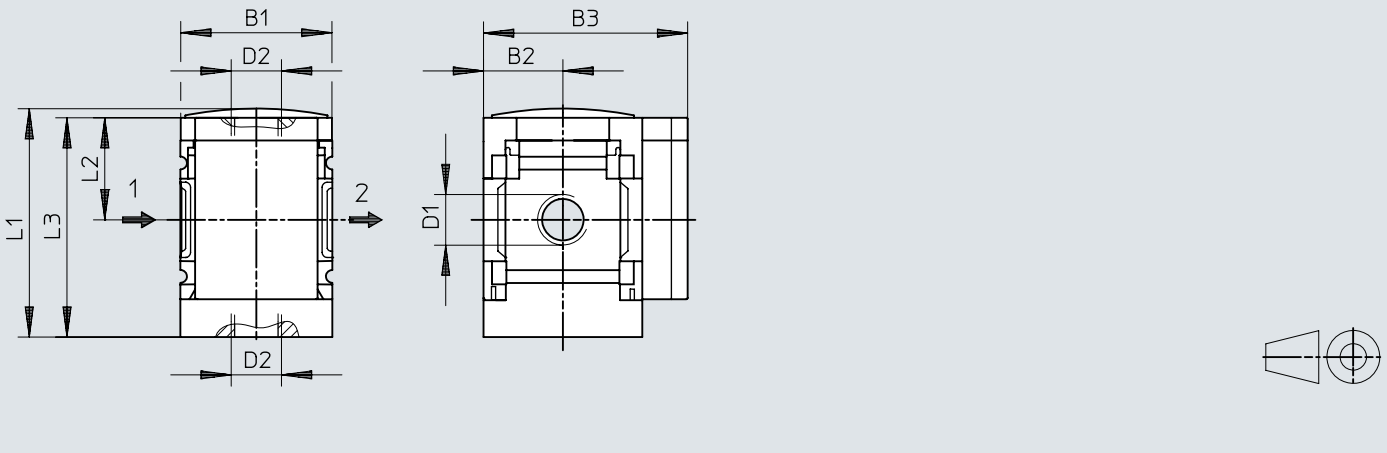

	B1	B2	B3	D1	D2	L1	L2	L3
MS6-FRM-1/4	62	31	76	G1/4	G1/2	87,2	39	84,5
MS6-FRM-3/8				G3/8				
MS6-FRM-1/2				G1/2				

Dimensions

Dimensions – AG Integrated MS pressure gauge with standard scale, RG integrated MS pressure gauge with red/green scale

Download CAD data → www.festo.com

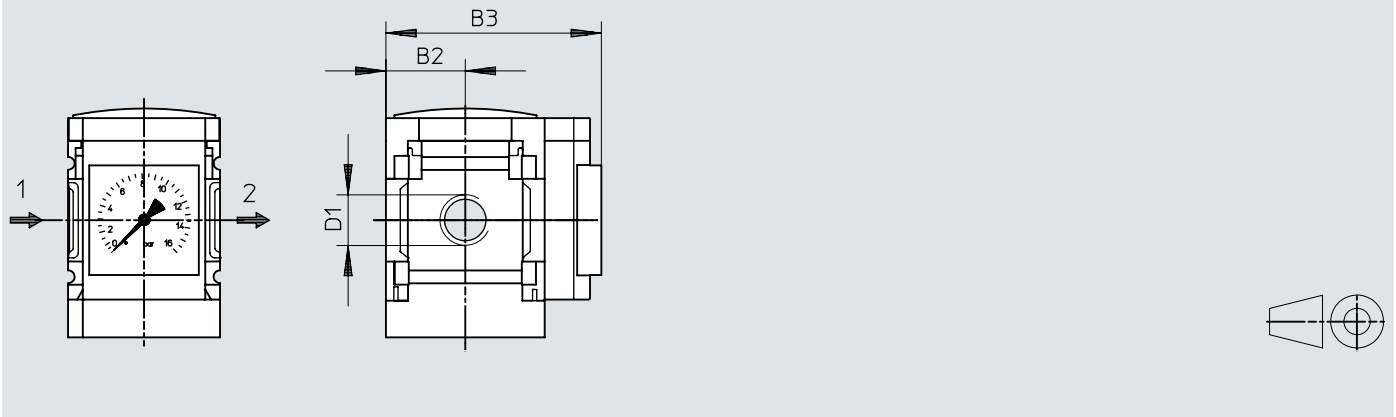

	B2	B3		D1
		1)	l	
MS6-FRM-1/4-...-AG	31	77	85	G1/4
MS6-FRM-3/8-...-AG				G3/8
MS6-FRM-1/2-...-AG				G1/2
MS6-FRM-1/4-...-RG	31	78,5	86,5	G1/4
MS6-FRM-3/8-...-RG				G3/8
MS6-FRM-1/2-...-RG				G1/2

1) Standard

Dimensions

Dimensions – A8 adapter for EN pressure gauge 1/8, without pressure gauge,
A4 adapter for EN pressure gauge 1/4, without pressure gauge

Download CAD data → www.festo.com

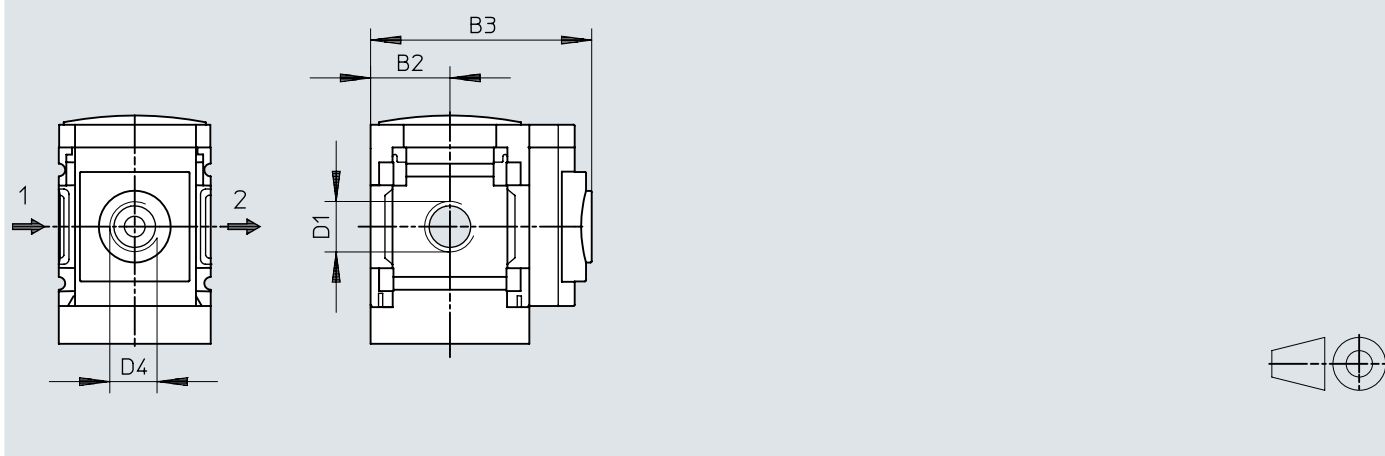

	B2	B3		D1	D4
		1)	l		
MS6-FRM-1/4-...-A8	31	78,5		G1/4	G1/8
MS6-FRM-3/8-...-A8				G3/8	
MS6-FRM-1/2-...-A8				G1/2	
MS6-FRM-1/4-...-A4	31	78,5		G1/4	G1/4
MS6-FRM-3/8-...-A4				G3/8	
MS6-FRM-1/2-...-A4				G1/2	

1) Standard

Dimensions

Dimensions – AD7/AD8/AD9/AD10 Pressure sensor with status indicator

Download CAD data → www.festo.com

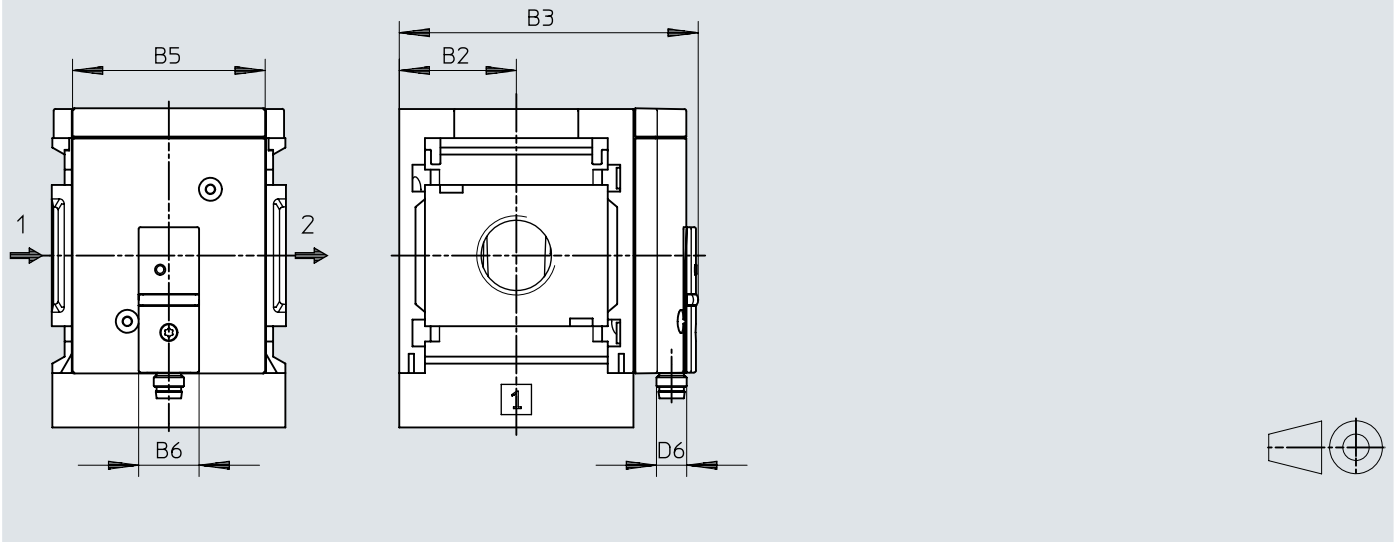

	B2	B3	B5	B6	D6
MS6-...-AD7, AD8, AD9, AD10	31	79,1	~51	16	M8x1

Dimensions

Dimensions – AD11, AD12 pressure sensor with LCD display

Download CAD data → www.festo.com

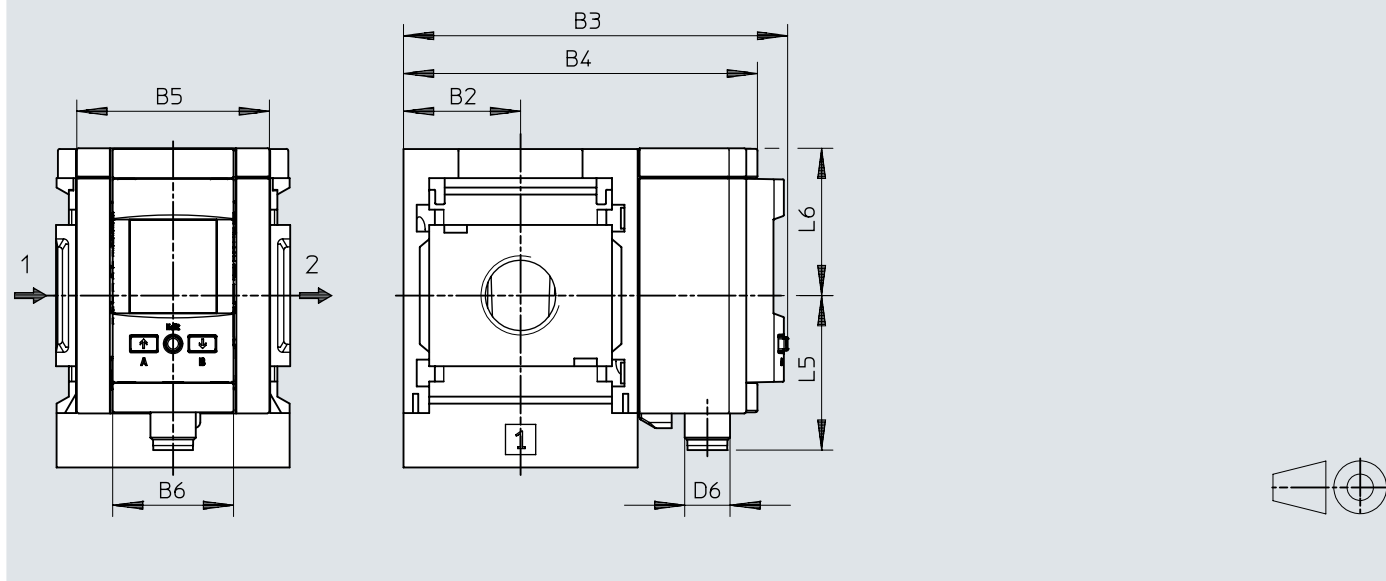

	B2	B3	B4	B5	B6	D6	L5	L6
MS6-...-AD11	31	101,8	93,7	51	32	M12x1	41,2	39
MS6-...-AD12						M8x1	37,9	

Dimensions

Dimensions – X/Y pressure switch with adjustable pressure switching point

Download CAD data → www.festo.com

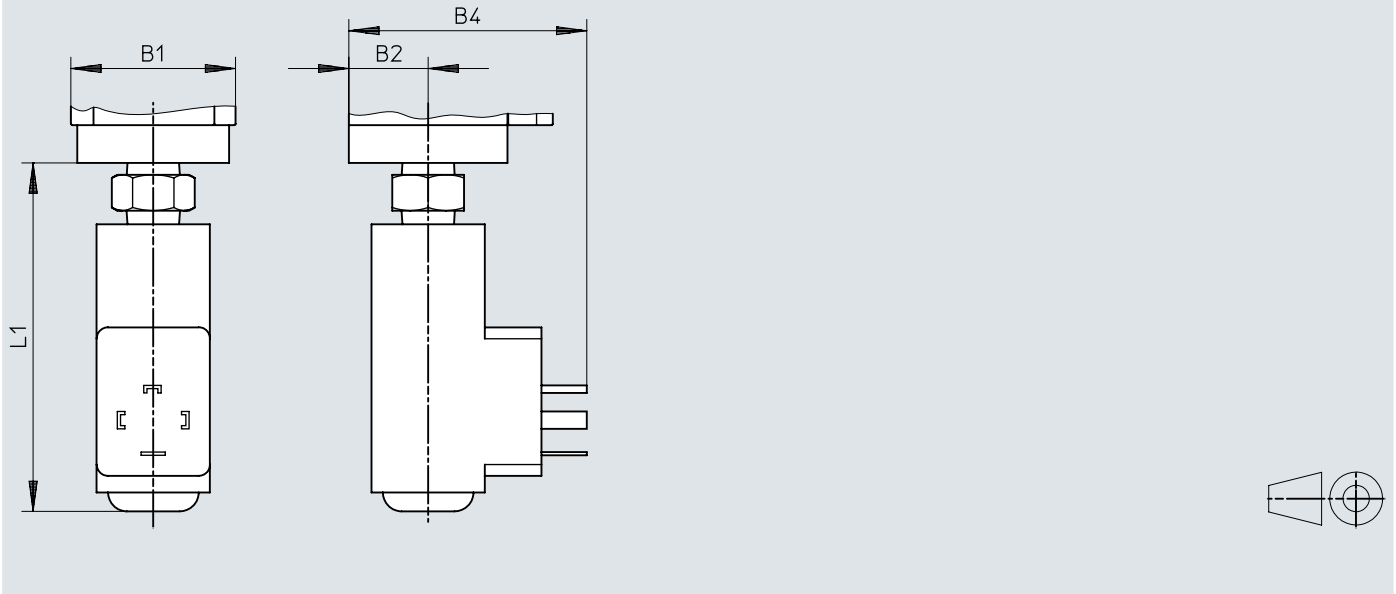

	B1	B2	B4	L1
MS6-FRM-...-X/Y	62	31	73	99

Dimensions

Dimensions – M12 pressure switch with adjustable pressure switching point

Download CAD data → www.festo.com

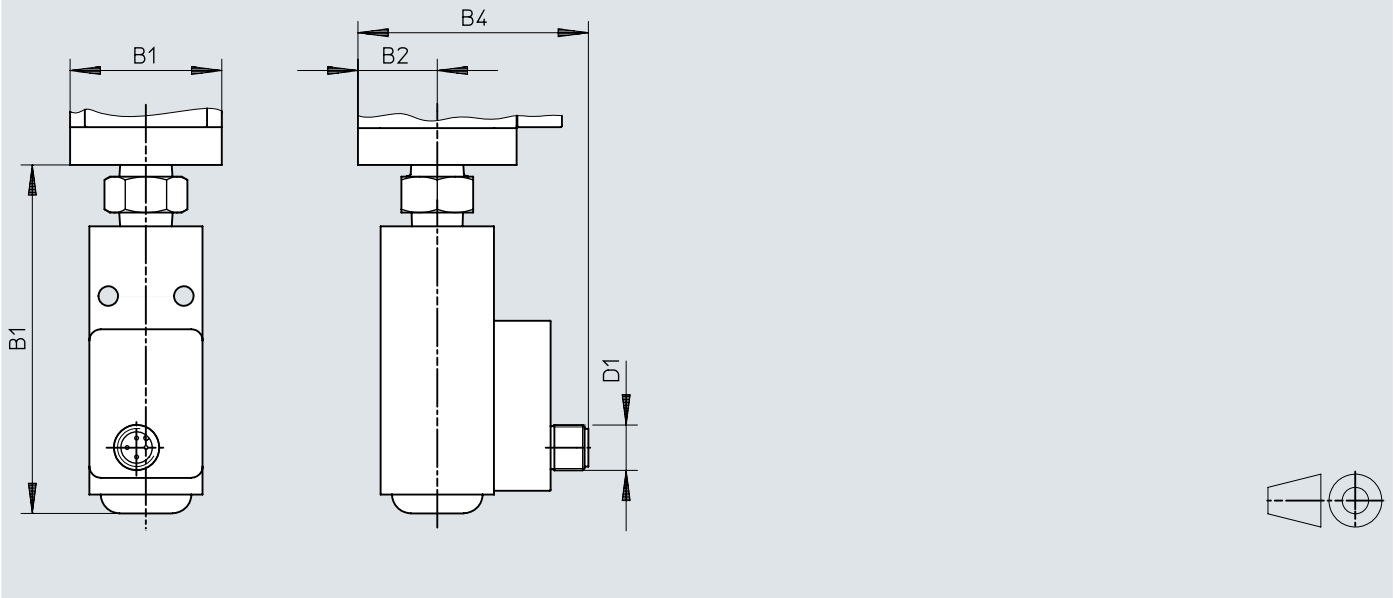

	B1	B2	B4	D1	L1
MS6-FRM-...-M12	62	31	71	M12x1	99

Ordering data

Ordering data						
	Pneumatic connection, port 1	Flow direction	Design	Product weight	Part no.	Type
	G1/4	From left to right	Branching module, With non-return function	400 g	536967	MS6-FRM-1/4-I
			Branching module	458 g	529857	MS6-FRM-1/4
	736 g			529858	MS6-FRM-1/4-Y	
	458 g			529861	MS6-FRM-3/8	
	G3/8		From left to right	736 g	529862	MS6-FRM-3/8-Y
				G1/2	Branching module, With non-return function	400 g
	From right to left	Branching module	458 g			529856
			From left to right		★ 529853	MS6-FRM-1/2
	From right to left	Branching module	736 g	529854	MS6-FRM-1/2-Y	
			529855	MS6-FRM-1/2-Y-Z		

Ordering information – Products for battery production

	Pneumatic connection, port 1	Pressure gauge alternatives	Product weight	Part no.	Type
	G1/2	Adapter for EN pressure gauge 1/4, without pressure gauge	458 g	8183566	MS6-FRM-1/2-A4-F1A
		Adapter for EN pressure gauge 1/8, without pressure gauge		8183567	MS6-FRM-1/2-A8-F1A

Ordering data – Modular product system

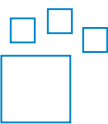
	Design	Part no.	Type
	Branching module	527676	MS6-FRM

Peripherals

Peripherals overview

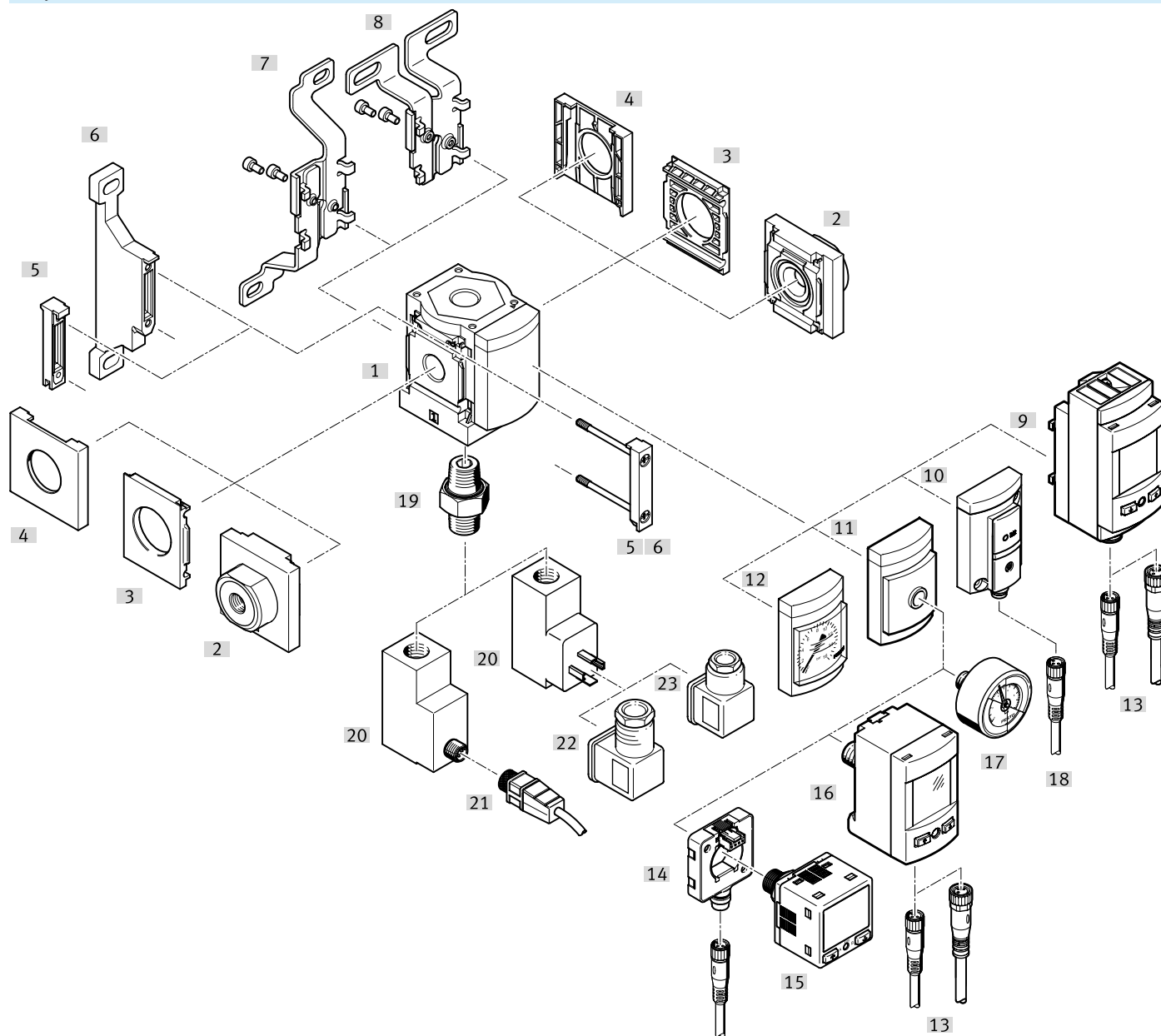

Accessories		→ Page/Internet
Type/order code	Description	
[1]	Branching module MS6-FRM	ms6-frm
[2]	Connecting plate-SET MS6-AG...	Module connector MS4/6-MV [5] or mounting bracket MS4-WP, WPB, WPE, WPM [6] is required for mounting.
[3]	Mounting plate MS6-AEND	Module connector MS4/6-MV [5] or mounting bracket MS4-WP, WPB, WPE, WPM [6] is required for mounting.
[4]	Cover cap MS6-END	18
[5]	Module connector MS6-MV	17
[6]	Mounting bracket MS6-WP	17
[6]	Mounting bracket MS6-WPB	Without illustration
[6]	Mounting bracket MS6-WPE	Without illustration
[6]	Mounting bracket MS6-WPM	Without illustration
[7]	Mounting bracket MS6-WB	17
[8]		-
[10]	Pressure sensor with LCD display SPAU	Order code [AD11], [AD12]
[11]	Pressure sensor with status indicator SDE5	Order code [AD7], [AD8], [AD9], [AD10]
[12]	Adapter for EN pressure gauge 1/8, 1/4	Order code [A8], [A4]

Peripherals

Accessories		→ Page/Internet
Type/order code	Description	
[13]	Pressure gauge MS	ms6-frm
[14]	Connecting cable NEBU-M8...-LE3, NEBU-M12...-LE4	18
[15]	Connecting cable NEBU-M8...-LE4, NEBU-M12...-LE4	18
[16]	Electrical adapter SASC	17
[17]	Pressure sensor SPAN	17
[18]	Pressure sensor SPAU-...-T	18
[19]	Pressure gauge MA	18
[20]	Connecting cable NEBU-M8...-LE3	18
[21]	Double nipple ESK	19
[22]	Pressure switch PEV	pev Order code: [X]/[Y]/[M12] Double nipple [21] is included in the scope of delivery.
[23]	Connecting cable NEBU-M12...-LE4	18
[24]	Angled plug socket PEV-1/4-WD-LED-...	19
[25]	Plug socket MSSD-C-4P	mssd

Accessories

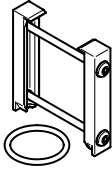
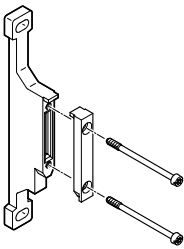
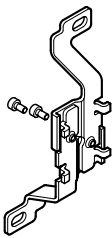
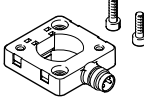
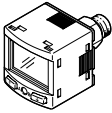
Module connector MS6-MV1				
	Size	Part no.	Type	
	6	★ 8119204	MS6-MV1	
		8176697	MS6-MV1-F1A	
Mounting bracket MS6-WP...				
	Size	Part no.	Type	
	6	★ 532195	MS6-WP	
		532186	MS6-WPM-2D	
		526073	MS6-WPM-D	
		★ 526074	MS6-WPB	
		541542	MS6-WPB-EX	
		8176698	MS6-WP-F1A	
		541544	MS6-WP-EX	
Mounting bracket MS6-WB				
	Size	Part no.	Type	
	6	★ 532196	MS6-WB	
Electrical adapter SASC				
	Short type code	Part no.	Type	
	SASC	★ 8000326	SASC-P4-A-M8-A	
Pressure sensor SPAN				
	Pneumatic connection	Analogue output	Part no.	Type
	Male thread G1/8, Female thread M5	0 - 10 V, 4 - 20 mA, 1 - 5 V	★ 8035544	SPAN-P10R-G18M-PN-PN-L1
			★ 8035533	SPAN-P10R-G18M-PNLK-PNVBA-L1
	Male thread R1/8, Female thread M5	0 - 10 V, 4 - 20 mA, 1 - 5 V	★ 8035547	SPAN-P10R-R18M-PN-PN-L1
			★ 8035536	SPAN-P10R-R18M-PNLK-PNVBA-L1

Accessories

Pressure sensor SPAU-...-T

	Pneumatic connection	Electrical connection 1, connector system	Part no.	Type
	R1/8	M12x1, A-coded to EN 61076-2-101	8001206	SPAU-P10R-T-R18M-L-PNLK-PNVBA-M12D
		M8x1, A-coded, to EN 61076-2-104	8001203	SPAU-P10R-T-R18M-L-PNLK-PNVBA-M8D
	R1/4	M12x1, A-coded to EN 61076-2-101	8001208	SPAU-P10R-T-R14M-L-PNLK-PNVBA-M12D
		M8x1, A-coded, to EN 61076-2-104	8001209	SPAU-P10R-T-R14M-L-PNLK-PNVBA-M8D

Connecting cable NEBU-M8

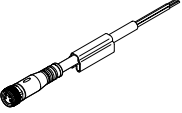
	Electrical connection 1, connector system	Electrical connection 1, number of connections/ cores	Electrical connection 1, cable outlet	Cable length	Part no.	Type
	M8x1, A-coded, to EN 61076-2-104	3	Straight	2.5 m	541333	NEBU-M8G3-K-2.5-LE3
				5 m	541334	NEBU-M8G3-K-5-LE3
			Angled	2.5 m	541338	NEBU-M8W3-K-2.5-LE3
				5 m	541341	NEBU-M8W3-K-5-LE3
		4	Straight	2.5 m	541342	NEBU-M8G4-K-2.5-LE4
				5 m	541343	NEBU-M8G4-K-5-LE4
			Angled	2.5 m	541344	NEBU-M8W4-K-2.5-LE4
				5 m	541345	NEBU-M8W4-K-5-LE4

Connecting cable NEBU-M12

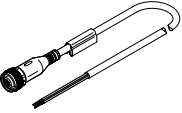
	Electrical connection 1, connector system	Electrical connection 1, number of connections/ cores	Electrical connection 1, cable outlet	Cable length	Part no.	Type
	M12x1, A-coded to EN 61076-2-101	5	Straight	2.5 m	541363	NEBU-M12G5-K-2.5-LE3
					550326	NEBU-M12G5-K-2.5-LE4
				5 m	541328	NEBU-M12G5-K-5-LE4
					541364	NEBU-M12G5-K-5-LE3
			Angled	2.5 m	550325	NEBU-M12W5-K-2.5-LE4
					541329	NEBU-M12W5-K-5-LE4

Pressure gauge MA

	Pneumatic connection	Part no.	Type
	G1/4	183901	MA-40-16-G1/4-EN
	R1/8	525726	MA-40-16-R1/8-E-RG
	R1/4	187080	MA-40-16-R1/4-EN
		525729	MA-50-16-R1/4-E-RG

Cover cap MS6-END

	Size	Part no.	Type
	6	538780	MS6-END

Accessories

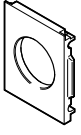
Mounting plate MS6-AEND				
	Size	Part no.	Type	
	6	535408	MS6-AEND1	

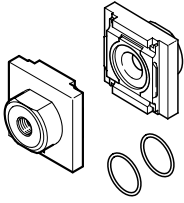
Connecting plate-SET MS6-AG...					
	Size	Pneumatic connection, port 1	Pneumatic connection, port 2	Part no.	Type
	6	G1/4	G1/4	526080	MS6-AGB
				541538	MS6-AGB-EX
		G3/8	G3/8	526081	MS6-AGC
				541539	MS6-AGC-EX
		G1/2	G1/2	★ 526082	MS6-AGD
				541540	MS6-AGD-EX
		G3/4	G3/4	★ 526083	MS6-AGE
				541541	MS6-AGE-EX

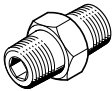
Double nipple ESK				
	Pneumatic connection, port 1	Pneumatic connection, port 2	Part no.	Type
	R1/4	R1/4	151521	ESK-1/4-1/4
		R1/2	534153	ESK-1/4-1/2

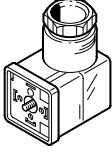
Angled plug socket PEV						
	Operational voltage range AC	Operational voltage range DC	Electrical connection	Switching status indication	Part no.	Type
		15 ... 30 V		Yellow LED, Green LED	164274	PEV-1/4-WD-LED-24
	150 ... 230 V	140 ... 180 V			164275	PEV-1/4-WD-LED-230

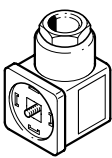
Plug socket MSSD				
	Electrical connection	Type of mounting	Part no.	Type
	3-pin, Angled socket, Type A, To DIN EN 175301-803, Square design MSC, Square design MSN1	On solenoid valve via M3 central screw	171157	MSSD-C-4P