

## Pressure regulator LR, LRS

**FESTO**



## Characteristics

### At a glance

- Also suitable for front panel mounting
- Two pressure gauge connections for variable installation
- High flow rate performance
- Two pressure control ranges: 0.5 ... 7 bar and 0.5 ... 12 bar
- Setting values are secured by locking the rotary knob
- Return flow option for exhausting from output 2 to input 1 already integrated
- Optional pressure sensor

### Version

[D] D series, metal

Sturdy in full metal design for the specific requirements of the process automation industry

### Pressure gauge

[ ] With pressure gauge

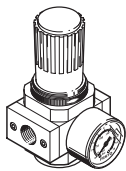

[O] Without pressure gauge

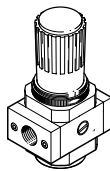

### Additional function

[ ] None

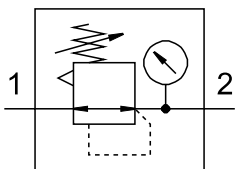

With pressure gauge

[I] With integrated non-return function

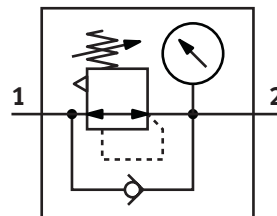

With pressure gauge

[DI] Directly actuated pressure regulator with integrated return flow function

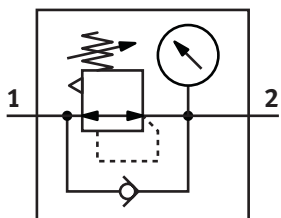

With pressure gauge

## Type code

001	Series
LR	Pressure regulator
LRS	Pressure regulator, lockable

002	Pneumatic connection
	None
1/8	Female thread G1/8
1/4	Female thread G1/4
3/8	Female thread G3/8
1/2	Female thread G1/2
3/4	Female thread G3/4
1	Female thread G1

003	Version
D	D series, metal

004	Pressure regulation range
	0.5 ... 12 bar (0.05 ... 1.2 MPa)
7	0.5 ... 7 bar (0.05 ... 0.7 MPa)

005	Pressure gauge
	With pressure gauge
0	Without pressure gauge

006	Additional function
	None
I	With integrated non-return function
DI	Directly actuated pressure regulator with integrated return flow function

007	Size
MINI	Grid dimension 40 mm (without connecting plates)
MIDI	Grid dimension 55 mm (without connecting plates)
MAXI	Grid dimension 66 mm (without connecting plates)

## Datasheet

### General technical data

Pneumatic connection, port 1	G1/8	G1/4	G3/8	G1/2	G3/4	G1
Pneumatic connection, port 2	G1/8	G1/4	G3/8	G1/2	G3/4	G1
Size	Mini	Midi, Mini		Maxi, Midi		Maxi
Design	Directly actuated diaphragm regulator			Directly actuated diaphragm regulator Piloted piston regulator		
Controller function	Output pressure constant Via primary pressure compensation With secondary venting With return flow function					
Type of mounting	Front panel mounting In-line installation With accessories					
Mounting position	optional					
Actuator lock	Rotary knob with detent Rotary knob with integrated lock					
Pressure regulation range	0.5 ... 12 bar					
Max. pressure hysteresis	0.2 bar			0.2 ... 0.4 bar		0.4 bar
Pressure gauge (ANALOG) or Pressure display (DIGITAL)	Prepared for G1/8 With pressure gauge	Prepared for G1/4 Prepared for G1/8 With pressure gauge	Prepared for G1/4 With pressure gauge			

### Operating and environmental conditions

Operating pressure	0 ... 1.6 MPa
Operating pressure	0 ... 16 bar
Operating pressure	0 ... 232 psi
Operating medium	Compressed air to ISO 8573-1:2010 [7:4:4], Inert gases
Note on operating and pilot medium	Lubricated operation possible (in which case lubricated operation will always be required)
Ambient temperature	-10 ... 60°C
Media temperature	-10 ... 60°C
Corrosion resistance class CRC <sup>1)</sup>	2 - Moderate corrosion stress

1) More information [www.festo.com/x/topic/crc](http://www.festo.com/x/topic/crc)

### Materials

Material housing	Die-cast zinc
Material membrane	NBR
Material sub-base	Die-cast zinc
Material seals	NBR
Note on materials	RoHS-compliant
LABS (PWIS) conformity	VDMA24364-B1/B2-L

## Datasheet

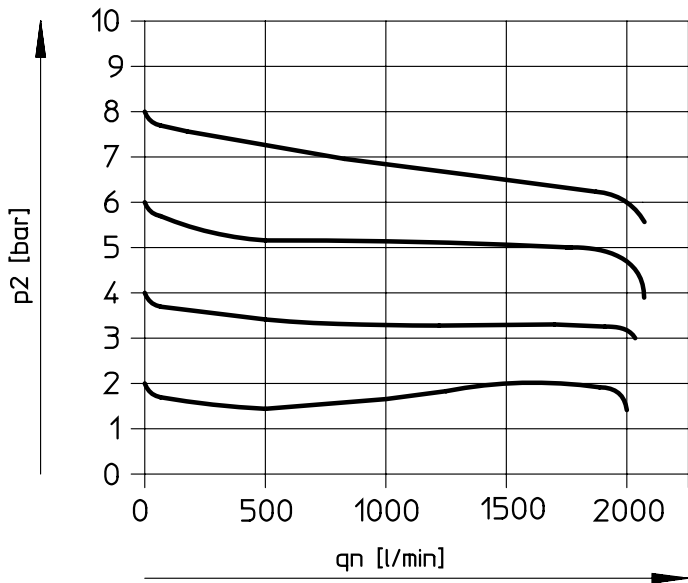
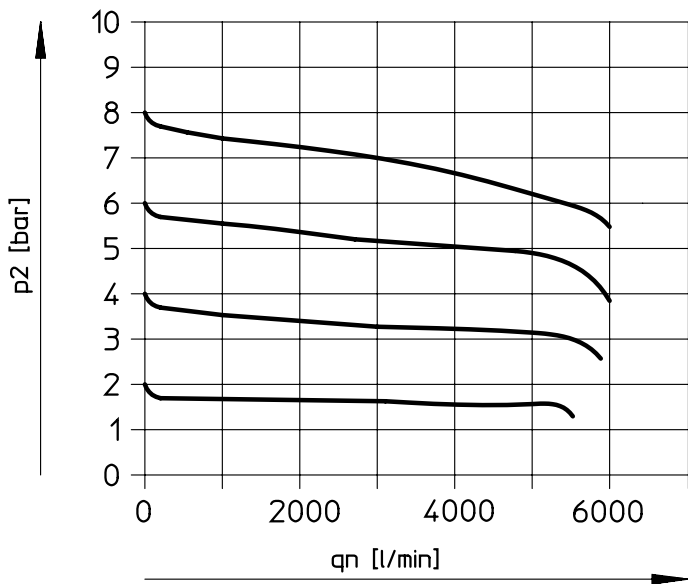
Standard flow rate  $q_n$  as a function of output pressure  $p_2$  ( $p_1 = 10$  bar) – LR/LRS-1/4-D-MINIStandard flow rate  $q_n$  as a function of output pressure  $p_2$  ( $p_1 = 10$  bar) – LR/LRS-1/2-D-MIDI

Datasheet

Standard flow rate  $q_n$  as a function of output pressure  $p_2$  ( $p_1 = 10$  bar) – LR/LRS-1-D-MAXI

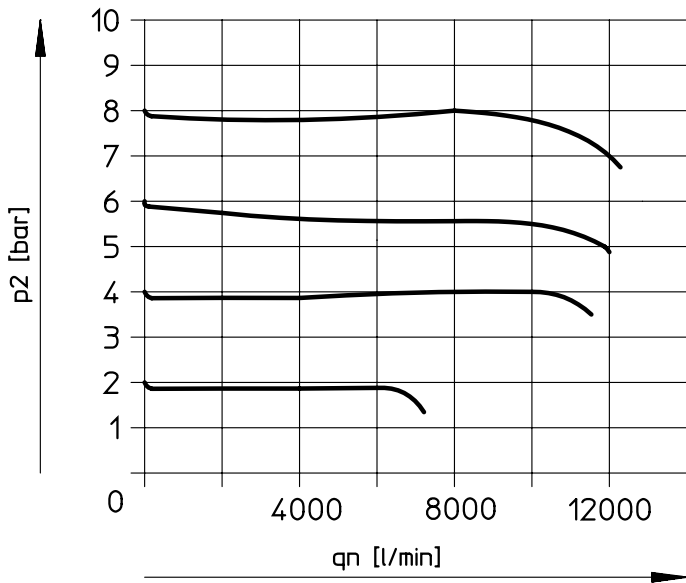

Standard flow rate  $q_n$  as a function of output pressure  $p_2$  ( $p_1 = 10$  bar) – LR/LRS-1-D-DI-MAXI

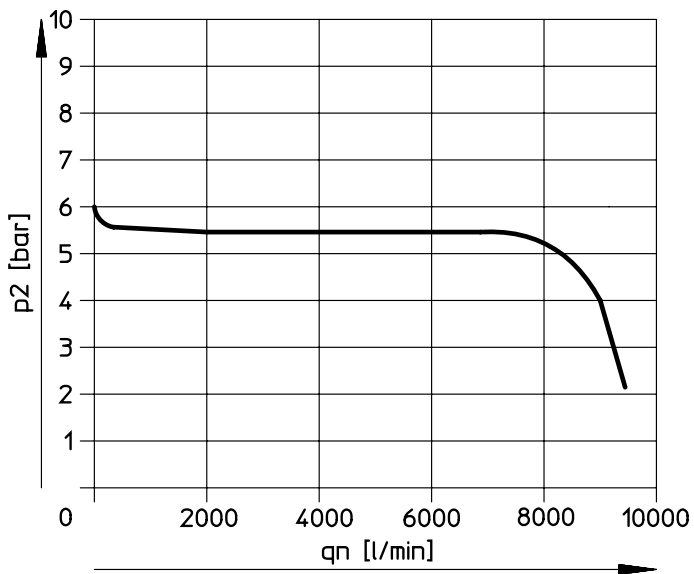

## Dimensions

Dimensions– Mini/Midi/Maxi, lockable

Download CAD data [www.festo.com](http://www.festo.com)

LR-...

LRS-...

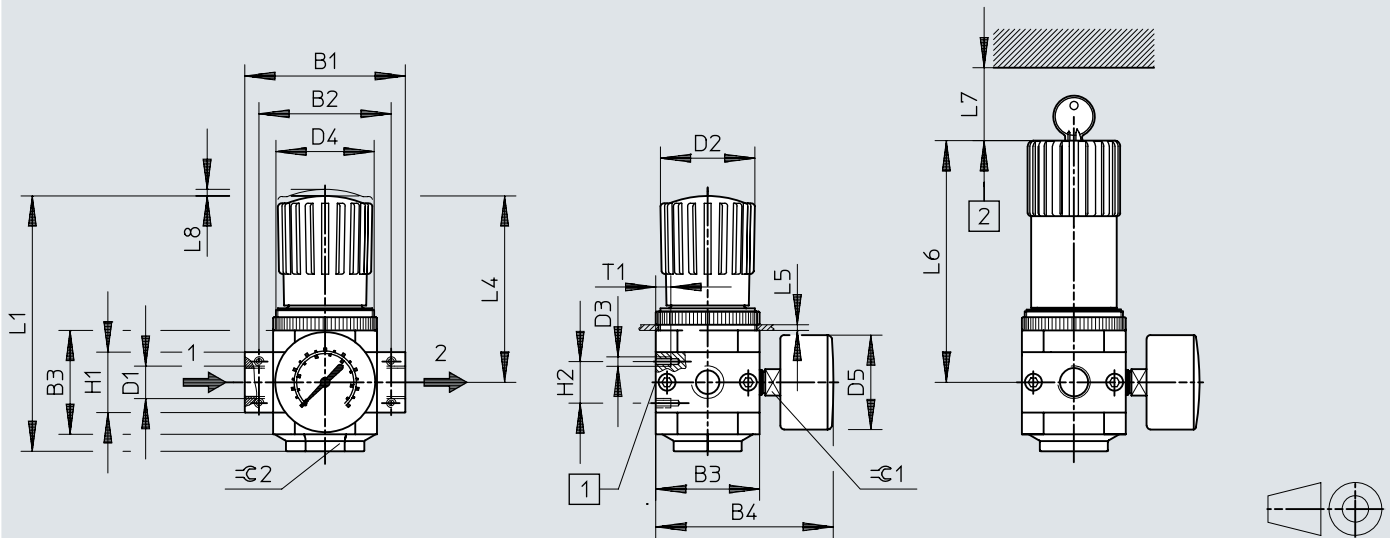

- [1] Second pressure gauge connection
- [2] Installation dimension

	B1	B2	B3	B4	D1	D2 ∅	D3	D4	D5 ∅		
LR/LRS-1/8-D-(I)-MINI	64	52	40	76	G1/8	31	M4	M36x1,5	39		
LR/LRS-1/4-D-(I)-MINI											G1/4
LR/LRS-3/8-D-(I)-MINI	70										G3/8
LR/LRS-1/4-D-(I)-MIDI	85	70	55	95	G1/4	50	M5	M52x1,5	39 (49) <sup>1)</sup>		
LR/LRS-3/8-D-(I)-MIDI					G3/8						
LR/LRS-1/2-D-(I)-MIDI					G1/2						
LR/LRS-3/4-D-(I)-MIDI					G3/4						
LR/LRS-1/2-D-MAXI	96	80	66	106	G1/2	31	M5	M36x1,5	39 (49) <sup>1)</sup>		
LR/LRS-1/2-D-DI-MAXI				105		49		M52x1,5			
LR/LRS-3/4-D-MAXI				106	31	M36x1,5					
LR/LRS-3/4-D-DI-MAXI				105	49	M52x1,5					
LR/LRS-1-D-MAXI				116	91	106		G1		31	M36x1,5
LR/LRS-1-D-DI-MAXI			105	49	M52x1,5						

	H1	H2	L1	L4	L5 max.	L6	L7	T1	∅ 1	∅ 2
LR/LRS-1/8-D-(I)-MINI	20	11	95	68	3	98	60	7	14	17
LR/LRS-1/4-D-(I)-MINI										
LR/LRS-3/8-D-(I)-MINI										
LR/LRS-1/4-D-(I)-MIDI	32	22	135	99	5	130	60	8	14	36
LR/LRS-3/8-D-(I)-MIDI										
LR/LRS-1/2-D-(I)-MIDI										
LR/LRS-3/4-D-(I)-MIDI										
LR/LRS-1/2-D-MAXI	32	22	125	82	4	111	60	8	14	22
LR/LRS-1/2-D-DI-MAXI	32		148	105		135				
LR/LRS-3/4-D-MAXI	32		125	82		111				
LR/LRS-3/4-D-DI-MAXI	36		148	105		135				
LR/LRS-1-D-MAXI	40		125	82		111				
LR/LRS-1-D-DI-MAXI	41	148	105	135						

- 1) Pressure gauge with outer scale in MPa and inner scale in bar
- 2) Note: This product complies with ISO 1179-1 and ISO 228-1.

## Ordering data

Pressure regulators LR – rotary knob with latch, connecting plates with threaded connection (with pressure gauge, outer scale in bar, inner scale in psi)								
Size	Pneumatic connection, port 1	Pressure regulation range	Standard nominal flow rate (standardised to DIN 1343)	Product weight	Part no.	Type		
Maxi		0.5 ... 12 bar	11,500 l/min		546436	LR-D-MAXI		
	G1/2	0.5 ... 7 bar	10,700 l/min	1,200 g	186457	LR-1/2-D-7-MAXI		
		0.5 ... 12 bar	10,500 l/min	800 g	186455	LR-1/2-D-MAXI		
	G3/4	0.5 ... 7 bar	12,000 l/min	1,200 g	162588	LR-3/4-D-7-MAXI		
		0.5 ... 12 bar	11,000 l/min	800 g	159626	LR-3/4-D-MAXI		
	G1	0.5 ... 7 bar	12,500 l/min	1,200 g	162589	LR-1-D-7-MAXI		
0.5 ... 12 bar		11,500 l/min	800 g	159627	LR-1-D-MAXI			
Midi	G1/4	0.5 ... 7 bar	2,200 l/min	720 g	186453	LR-1/4-D-7-MIDI		
		0.5 ... 12 bar	2,100 l/min		186451	LR-1/4-D-MIDI		
	G3/8	0.5 ... 7 bar	3,300 l/min		162585	LR-3/8-D-7-MIDI		
		0.5 ... 12 bar	3,200 l/min		159580	LR-3/8-D-MIDI		
	G1/2	0.5 ... 7 bar	4,000 l/min		162586	LR-1/2-D-7-MIDI		
		0.5 ... 12 bar	3,500 l/min		159581	LR-1/2-D-MIDI		
	G3/4	0.5 ... 7 bar	4,500 l/min		162587	LR-3/4-D-7-MIDI		
		0.5 ... 12 bar	3,500 l/min		162581	LR-3/4-D-MIDI		
	Mini	G1/8	0.5 ... 7 bar		1,000 l/min	350 g	162582	LR-1/8-D-7-MINI
			0.5 ... 12 bar		800 l/min		159624	LR-1/8-D-MINI
G1/4		0.5 ... 7 bar	1,600 l/min	162583	LR-1/4-D-7-MINI			
		0.5 ... 12 bar	1,500 l/min	159625	LR-1/4-D-MINI			
G3/8		0.5 ... 7 bar	1,800 l/min	162584	LR-3/8-D-7-MINI			
		0.5 ... 12 bar	1,700 l/min	162580	LR-3/8-D-MINI			

Pressure regulators LR – rotary knob with latch, connecting plates with threaded connection (with pressure gauge, outer scale in MPa, inner scale in bar – only available in Asia)								
Size	Pneumatic connection, port 1	Pressure regulation range	Standard nominal flow rate (standardised to DIN 1343)	Product weight	Part no.	Type		
Maxi	G1/2	0.5 ... 7 bar	10,700 l/min	1,200 g	8002371	LR-1/2-D-7-MAXI-MPA		
		0.5 ... 12 bar	10,500 l/min	800 g	8002370	LR-1/2-D-MAXI-MPA		
	G3/4	0.5 ... 7 bar	12,000 l/min	1,200 g	8002294	LR-3/4-D-7-MAXI-MPA		
		0.5 ... 12 bar	11,000 l/min	800 g	8002276	LR-3/4-D-MAXI-MPA		
	G1	0.5 ... 7 bar	12,500 l/min	1,200 g	8002295	LR-1-D-7-MAXI-MPA		
		0.5 ... 12 bar	11,500 l/min	800 g	8002277	LR-1-D-MAXI-MPA		
Midi	G1/4	0.5 ... 7 bar	2,200 l/min	720 g	8002369	LR-1/4-D-7-MIDI-MPA		
		0.5 ... 12 bar	2,100 l/min		8002368	LR-1/4-D-MIDI-MPA		
	G3/8	0.5 ... 7 bar	3,300 l/min		8002291	LR-3/8-D-7-MIDI-MPA		
		0.5 ... 12 bar	3,200 l/min		8002256	LR-3/8-D-MIDI-MPA		
	G1/2	0.5 ... 7 bar	4,000 l/min		8002292	LR-1/2-D-7-MIDI-MPA		
		0.5 ... 12 bar	3,500 l/min		8002257	LR-1/2-D-MIDI-MPA		
	G3/4	0.5 ... 7 bar	4,500 l/min		8002293	LR-3/4-D-7-MIDI-MPA		
		0.5 ... 12 bar	3,500 l/min		8002287	LR-3/4-D-MIDI-MPA		
	Mini	G1/8	0.5 ... 7 bar		1,000 l/min	350 g	8002288	LR-1/8-D-7-MINI-MPA
			0.5 ... 12 bar		800 l/min		8002274	LR-1/8-D-MINI-MPA
G1/4		0.5 ... 7 bar	1,600 l/min	8002289	LR-1/4-D-7-MINI-MPA			
		0.5 ... 12 bar	1,500 l/min	8002275	LR-1/4-D-MINI-MPA			
G3/8		0.5 ... 7 bar	1,800 l/min	8002290	LR-3/8-D-7-MINI-MPA			
		0.5 ... 12 bar	1,700 l/min	8002286	LR-3/8-D-MINI-MPA			

Pressure regulators LR – rotary knob with latch, connecting plates with threaded connection (without pressure gauge)						
Size	Pneumatic connection, port 1	Pressure regulation range	Standard nominal flow rate (standardised to DIN 1343)	Product weight	Part no.	Type
Maxi	G1/2	0.5 ... 7 bar	10,700 l/min	1,100 g	186458	LR-1/2-D-7-O-MAXI
		0.5 ... 12 bar	10,500 l/min	700 g	186456	LR-1/2-D-O-MAXI
	G3/4	0.5 ... 7 bar	12,000 l/min	1,100 g	162604	LR-3/4-D-7-O-MAXI
		0.5 ... 12 bar	11,000 l/min	700 g	162596	LR-3/4-D-O-MAXI
	G1	0.5 ... 7 bar	12,500 l/min	1,100 g	162605	LR-1-D-7-O-MAXI
		0.5 ... 12 bar	11,500 l/min	700 g	162597	LR-1-D-O-MAXI
Midi	G1/4	0.5 ... 7 bar	2,200 l/min	660 g	186454	LR-1/4-D-7-O-MIDI



## Ordering data

Pressure regulators LR – rotary knob with latch, connecting plates with threaded connection (without pressure gauge)						
Size	Pneumatic connection, port 1	Pressure regulation range	Standard nominal flow rate (standardised to DIN 1343)	Product weight	Part no.	Type
Midi	G1/4	0.5 ... 12 bar	2,100 l/min	660 g	186452	LR-1/4-D-O-MIDI
		0.5 ... 7 bar	3,300 l/min		162601	LR-3/8-D-7-O-MIDI
	G3/8	0.5 ... 12 bar	3,200 l/min		162593	LR-3/8-D-O-MIDI
		0.5 ... 7 bar	4,000 l/min		162602	LR-1/2-D-7-O-MIDI
	G1/2	0.5 ... 12 bar	3,500 l/min		162594	LR-1/2-D-O-MIDI
		0.5 ... 7 bar	4,500 l/min		162603	LR-3/4-D-7-O-MIDI
	G3/4	0.5 ... 12 bar	3,500 l/min		162595	LR-3/4-D-O-MIDI
		0.5 ... 7 bar	1,000 l/min		162598	LR-1/8-D-7-O-MINI
Mini	G1/8	0.5 ... 12 bar	800 l/min	300 g	162590	LR-1/8-D-O-MINI
		0.5 ... 7 bar	1,600 l/min		162599	LR-1/4-D-7-O-MINI
	G1/4	0.5 ... 12 bar	1,500 l/min		162591	LR-1/4-D-O-MINI
		0.5 ... 7 bar	1,800 l/min		162600	LR-3/8-D-7-O-MINI
	G3/8	0.5 ... 12 bar	1,700 l/min		162592	LR-3/8-D-O-MINI

Pressure regulators LR – with integrated reverse flow function, rotary knob with latch, connecting plates with threaded connection (with pressure gauge, outer scale in bar, inner scale in psi)								
Size	Pneumatic connection, port 1	Pressure regulation range	Standard nominal flow rate (standardised to DIN 1343)	Product weight	Part no.	Type		
Midi	G1/4	0.5 ... 7 bar	2,200 l/min	720 g	192311	LR-1/4-D-7-I-MIDI		
		0.5 ... 12 bar	2,100 l/min		192310	LR-1/4-D-I-MIDI		
	G3/8	0.5 ... 7 bar	3,300 l/min		192313	LR-3/8-D-7-I-MIDI		
		0.5 ... 12 bar	3,200 l/min		192312	LR-3/8-D-I-MIDI		
	G1/2	0.5 ... 7 bar	4,000 l/min		192315	LR-1/2-D-7-I-MIDI		
		0.5 ... 12 bar	3,500 l/min		192314	LR-1/2-D-I-MIDI		
	G3/4	0.5 ... 7 bar	4,500 l/min		192317	LR-3/4-D-7-I-MIDI		
		0.5 ... 12 bar	3,500 l/min		192316	LR-3/4-D-I-MIDI		
	Mini	G1/8	0.5 ... 7 bar		1,000 l/min	350 g	192299	LR-1/8-D-7-I-MINI
			0.5 ... 12 bar		800 l/min		192298	LR-1/8-D-I-MINI
G1/4		0.5 ... 7 bar	1,600 l/min	192301	LR-1/4-D-7-I-MINI			
		0.5 ... 12 bar	1,500 l/min	192300	LR-1/4-D-I-MINI			
G3/8		0.5 ... 7 bar	1,800 l/min	192303	LR-3/8-D-7-I-MINI			
		0.5 ... 12 bar	1,700 l/min	192302	LR-3/8-D-I-MINI			

Pressure regulators LR – with integrated reverse flow function, rotary knob with latch, connecting plates with threaded connection (with pressure gauge, outer scale in MPa, inner scale in bar – only available in Asia)						
Size	Pneumatic connection, port 1	Pressure regulation range	Standard nominal flow rate (standardised to DIN 1343)	Product weight	Part no.	Type
Midi	G1/4	0.5 ... 12 bar	2,100 l/min	720 g	8002394	LR-1/4-D-I-MIDI-MPA
		0.5 ... 7 bar	3,300 l/min		8002395	LR-3/8-D-7-I-MIDI-MPA
	G1/2	0.5 ... 12 bar	3,500 l/min		8002396	LR-1/2-D-I-MIDI-MPA
					8002397	LR-3/4-D-I-MIDI-MPA
Mini	G1/8	0.5 ... 7 bar	1,000 l/min	350 g	8002389	LR-1/8-D-7-I-MINI-MPA
		0.5 ... 12 bar	800 l/min		8002388	LR-1/8-D-I-MINI-MPA
	G1/4	0.5 ... 7 bar	1,600 l/min		8002391	LR-1/4-D-7-I-MINI-MPA
		0.5 ... 12 bar	1,500 l/min		8002390	LR-1/4-D-I-MINI-MPA
	G3/8	0.5 ... 7 bar	1,800 l/min		8002393	LR-3/8-D-7-I-MINI-MPA
		0.5 ... 12 bar	1,700 l/min		8002392	LR-3/8-D-I-MINI-MPA

Pressure regulators LR – with integrated reverse flow function, rotary knob with latch, connecting plates with threaded connection (without pressure gauge)						
Size	Pneumatic connection, port 1	Pressure regulation range	Standard nominal flow rate (standardised to DIN 1343)	Product weight	Part no.	Type
Midi	G1/4	0.5 ... 7 bar	2,200 l/min	660 g	192319	LR-1/4-D-7-O-I-MIDI
		0.5 ... 12 bar	2,100 l/min		192318	LR-1/4-D-O-I-MIDI
	G3/8	0.5 ... 7 bar	3,300 l/min		192321	LR-3/8-D-7-O-I-MIDI

## Ordering data

Pressure regulators LR – with integrated reverse flow function, rotary knob with latch, connecting plates with threaded connection (without pressure gauge)						
Size	Pneumatic connection, port 1	Pressure regulation range	Standard nominal flow rate (standardised to DIN 1343)	Product weight	Part no.	Type
Midi	G3/8	0.5 ... 12 bar	3,200 l/min	660 g	192320	LR-3/8-D-O-I-MIDI
		0.5 ... 7 bar	4,000 l/min		192323	LR-1/2-D-7-O-I-MIDI
	G1/2	0.5 ... 12 bar	3,500 l/min		192322	LR-1/2-D-O-I-MIDI
		0.5 ... 7 bar	4,500 l/min		192325	LR-3/4-D-7-O-I-MIDI
		0.5 ... 12 bar	3,500 l/min		192324	LR-3/4-D-O-I-MIDI
		0.5 ... 7 bar	1,000 l/min		192305	LR-1/8-D-7-O-I-MINI
Mini	G1/8	0.5 ... 12 bar	800 l/min	300 g	192304	LR-1/8-D-O-I-MINI
		0.5 ... 7 bar	1,600 l/min		192307	LR-1/4-D-7-O-I-MINI
	G1/4	0.5 ... 12 bar	1,500 l/min		192306	LR-1/4-D-O-I-MINI
		0.5 ... 7 bar	1,800 l/min		192309	LR-3/8-D-7-O-I-MINI
	G3/8	0.5 ... 12 bar	1,700 l/min		192308	LR-3/8-D-O-I-MINI

Pressure regulators LR – directly actuated pressure regulator with integrated reverse flow function, rotary knob with latch, connecting plates with threaded connection (with pressure gauge, outer scale in bar, inner scale in psi)						
Size	Pneumatic connection, port 1	Pressure regulation range	Standard nominal flow rate (standardised to DIN 1343)	Product weight	Part no.	Type
Maxi	G1/2	0.5 ... 7 bar	7,300 l/min	1,400 g	192358	LR-1/2-D-7-DI-MAXI
		0.5 ... 12 bar	5,400 l/min		192356	LR-1/2-D-DI-MAXI
	G3/4	0.5 ... 7 bar	8,350 l/min		192362	LR-3/4-D-7-DI-MAXI
		0.5 ... 12 bar	6,800 l/min		192360	LR-3/4-D-DI-MAXI
	G1	0.5 ... 7 bar	8,400 l/min		192366	LR-1-D-7-DI-MAXI
		0.5 ... 12 bar	7,000 l/min		192364	LR-1-D-DI-MAXI

Pressure regulators LR – directly actuated pressure regulator with integrated reverse flow function, rotary knob with latch, connecting plates with threaded connection (with pressure gauge, outer scale in MPa, inner scale in bar – only available in Asia)						
Size	Pneumatic connection, port 1	Pressure regulation range	Standard nominal flow rate (standardised to DIN 1343)	Product weight	Part no.	Type
Maxi	G3/4	0.5 ... 12 bar	6,800 l/min	1,400 g	8002398	LR-3/4-D-DI-MAXI-MPA

Pressure regulators LR – directly actuated with integrated reverse flow function, rotary knob with latch, connecting plates with threaded connection (without pressure gauge)						
Size	Pneumatic connection, port 1	Pressure regulation range	Standard nominal flow rate (standardised to DIN 1343)	Product weight	Part no.	Type
Maxi	G1/2	0.5 ... 7 bar	7,300 l/min	1,330 g	192359	LR-1/2-D-7-O-DI-MAXI
		0.5 ... 12 bar	5,400 l/min		192357	LR-1/2-D-O-DI-MAXI
	G3/4	0.5 ... 7 bar	8,350 l/min		192363	LR-3/4-D-7-O-DI-MAXI
		0.5 ... 12 bar	6,800 l/min		192361	LR-3/4-D-O-DI-MAXI
	G1	0.5 ... 7 bar	8,400 l/min		192367	LR-1-D-7-O-DI-MAXI
		0.5 ... 12 bar	7,000 l/min		192365	LR-1-D-O-DI-MAXI

Pressure regulator, lockable LRS – rotary knob with latch, connecting plates with threaded connection (with pressure gauge, outer scale in bar, inner scale in psi)						
Size	Pneumatic connection, port 1	Pressure regulation range	Standard nominal flow rate (standardised to DIN 1343)	Product weight	Part no.	Type
Maxi	G1/2	0.5 ... 7 bar	10,700 l/min	1,288 g	194660	LRS-1/2-D-7-MAXI
		0.5 ... 12 bar	10,500 l/min	888 g	194658	LRS-1/2-D-MAXI
	G3/4	0.5 ... 7 bar	12,000 l/min	1,288 g	194662	LRS-3/4-D-7-MAXI
		0.5 ... 12 bar	11,000 l/min	888 g	194664	LRS-3/4-D-MAXI
	G1	0.5 ... 7 bar	12,500 l/min	1,288 g	194668	LRS-1-D-7-MAXI
		0.5 ... 12 bar	11,500 l/min	888 g	194666	LRS-1-D-MAXI
Midi	G1/4	0.5 ... 7 bar	2,200 l/min	1,250 g	194630	LRS-1/4-D-7-MIDI
		0.5 ... 12 bar	2,100 l/min		194626	LRS-1/4-D-MIDI
	G3/8	0.5 ... 7 bar	3,300 l/min		194638	LRS-3/8-D-7-MIDI
		0.5 ... 12 bar	3,200 l/min		194634	LRS-3/8-D-MIDI
	G1/2	0.5 ... 7 bar	4,000 l/min		194646	LRS-1/2-D-7-MIDI
		0.5 ... 12 bar	3,500 l/min		194642	LRS-1/2-D-MIDI

## Ordering data

Pressure regulator, lockable LRS – rotary knob with latch, connecting plates with threaded connection (with pressure gauge, outer scale in bar, inner scale in psi)						
Size	Pneumatic connection, port 1	Pressure regulation range	Standard nominal flow rate (standardised to DIN 1343)	Product weight	Part no.	Type
Midi	G3/4	0.5 ... 7 bar	4,500 l/min	1,250 g	194656	LRS-3/4-D-7-MIDI
		0.5 ... 12 bar	3,500 l/min		194650	LRS-3/4-D-MIDI
Mini	G1/8	0.5 ... 7 bar	1,000 l/min	520 g	194606	LRS-1/8-D-7-MINI
		0.5 ... 12 bar	800 l/min	500 g	194602	LRS-1/8-D-MINI
	G1/4	0.5 ... 7 bar	1,600 l/min	520 g	194614	LRS-1/4-D-7-MINI
		0.5 ... 12 bar	1,500 l/min	500 g	194610	LRS-1/4-D-MINI
	G3/8	0.5 ... 7 bar	1,800 l/min	520 g	194622	LRS-3/8-D-7-MINI
		0.5 ... 12 bar	1,700 l/min	500 g	194618	LRS-3/8-D-MINI

Pressure regulator, lockable LRS – rotary knob with latch, connecting plates with threaded connection (with pressure gauge, outer scale in MPa, inner scale in bar – only available in Asia)						
Size	Pneumatic connection, port 1	Pressure regulation range	Standard nominal flow rate (standardised to DIN 1343)	Product weight	Part no.	Type
Mini	G1/8	0.5 ... 12 bar	800 l/min	500 g	8037013	LRS-1/8-D-MINI-MPA
	G1/4	0.5 ... 7 bar	1,600 l/min	520 g	8037015	LRS-1/4-D-7-MINI-MPA

Pressure regulator, lockable LRS – rotary knob with latch, connecting plates with threaded connection (without pressure gauge)								
Size	Pneumatic connection, port 1	Pressure regulation range	Standard nominal flow rate (standardised to DIN 1343)	Product weight	Part no.	Type		
Maxi	G1/2	0.5 ... 7 bar	10,700 l/min	1,215 g	194661	LRS-1/2-D-7-O-MAXI		
		0.5 ... 12 bar	10,500 l/min	815 g	194659	LRS-1/2-D-O-MAXI		
	G3/4	0.5 ... 7 bar	12,000 l/min	1,215 g	194663	LRS-3/4-D-7-O-MAXI		
		0.5 ... 12 bar	11,000 l/min	815 g	194665	LRS-3/4-D-O-MAXI		
	G1	0.5 ... 7 bar	12,500 l/min	1,215 g	194669	LRS-1-D-7-O-MAXI		
		0.5 ... 12 bar	11,500 l/min	815 g	194667	LRS-1-D-O-MAXI		
Midi	G1/4	0.5 ... 7 bar	2,200 l/min	1,180 g	194632	LRS-1/4-D-7-O-MIDI		
		0.5 ... 12 bar	2,100 l/min		194628	LRS-1/4-D-O-MIDI		
	G3/8	0.5 ... 7 bar	3,300 l/min		194640	LRS-3/8-D-7-O-MIDI		
		0.5 ... 12 bar	3,200 l/min		194636	LRS-3/8-D-O-MIDI		
	G1/2	0.5 ... 7 bar	4,000 l/min		194648	LRS-1/2-D-7-O-MIDI		
		0.5 ... 12 bar	3,500 l/min		194644	LRS-1/2-D-O-MIDI		
	G3/4	0.5 ... 7 bar	4,500 l/min		194654	LRS-3/4-D-7-O-MIDI		
		0.5 ... 12 bar	3,500 l/min		194652	LRS-3/4-D-O-MIDI		
	Mini	G1/8	0.5 ... 7 bar		1,000 l/min	470 g	194608	LRS-1/8-D-7-O-MINI
			0.5 ... 12 bar		800 l/min	450 g	194604	LRS-1/8-D-O-MINI
G1/4		0.5 ... 7 bar	1,600 l/min	470 g	194616	LRS-1/4-D-7-O-MINI		
		0.5 ... 12 bar	1,500 l/min	450 g	194612	LRS-1/4-D-O-MINI		
G3/8		0.5 ... 7 bar	1,800 l/min	470 g	194624	LRS-3/8-D-7-O-MINI		
		0.5 ... 12 bar	1,700 l/min	450 g	194620	LRS-3/8-D-O-MINI		

Pressure regulator, lockable LRS – with integrated reverse flow function, rotary knob with latch, connecting plates with threaded connection (with pressure gauge, outer scale in bar, inner scale in psi)						
Size	Pneumatic connection, port 1	Pressure regulation range	Standard nominal flow rate (standardised to DIN 1343)	Product weight	Part no.	Type
Midi	G1/4	0.5 ... 7 bar	2,200 l/min	1,250 g	194631	LRS-1/4-D-7-I-MIDI
		0.5 ... 12 bar	2,100 l/min		194627	LRS-1/4-D-I-MIDI
	G3/8	0.5 ... 7 bar	3,300 l/min		194639	LRS-3/8-D-7-I-MIDI
		0.5 ... 12 bar	3,200 l/min		194635	LRS-3/8-D-I-MIDI
	G1/2	0.5 ... 7 bar	4,000 l/min		194647	LRS-1/2-D-7-I-MIDI
		0.5 ... 12 bar	3,500 l/min		194643	LRS-1/2-D-I-MIDI
	G3/4				194651	LRS-3/4-D-I-MIDI
Mini	G1/8	0.5 ... 7 bar	1,000 l/min	500 g	194607	LRS-1/8-D-7-I-MINI
		0.5 ... 12 bar	800 l/min	194603	LRS-1/8-D-I-MINI	
	G1/4	0.5 ... 7 bar	1,600 l/min	194615	LRS-1/4-D-7-I-MINI	

## Ordering data

**Pressure regulator, lockable LRS – with integrated reverse flow function, rotary knob with latch, connecting plates with threaded connection (with pressure gauge, outer scale in bar, inner scale in psi)**

Size	Pneumatic connection, port 1	Pressure regulation range	Standard nominal flow rate (standardised to DIN 1343)	Product weight	Part no.	Type
Mini	G1/4	0.5 ... 12 bar	1,500 l/min	500 g	194611	LRS-1/4-D-I-MINI
	G3/8	0.5 ... 7 bar	1,800 l/min		194623	LRS-3/8-D-7-I-MINI
		0.5 ... 12 bar	1,700 l/min		194619	LRS-3/8-D-I-MINI

**Pressure regulator, lockable LRS – with integrated reverse flow function, rotary knob with latch, connecting plates with threaded connection (with pressure gauge, outer scale in MPa, inner scale in bar – only available in Asia)**

Size	Pneumatic connection, port 1	Pressure regulation range	Standard nominal flow rate (standardised to DIN 1343)	Product weight	Part no.	Type
Mini	G1/8	0.5 ... 7 bar	1,000 l/min	500 g	8037014	LRS-1/8-D-7-I-MINI-MPA
		0.5 ... 12 bar	800 l/min		8002400	LRS-1/8-D-I-MINI-MPA
	G1/4	0.5 ... 7 bar	1,600 l/min		8037016	LRS-1/4-D-7-I-MINI-MPA

**Pressure regulator, lockable LRS – with integrated reverse flow function, rotary knob with latch, connecting plates with threaded connection (without pressure gauge)**

Size	Pneumatic connection, port 1	Pressure regulation range	Standard nominal flow rate (standardised to DIN 1343)	Product weight	Part no.	Type		
Midi	G1/4	0.5 ... 7 bar	2,200 l/min	1,180 g	194633	LRS-1/4-D-7-O-I-MIDI		
		0.5 ... 12 bar	2,100 l/min		194629	LRS-1/4-D-O-I-MIDI		
	G3/8	0.5 ... 7 bar	3,300 l/min		194641	LRS-3/8-D-7-O-I-MIDI		
		0.5 ... 12 bar	3,200 l/min		194637	LRS-3/8-D-O-I-MIDI		
	G1/2	0.5 ... 7 bar	4,000 l/min		194649	LRS-1/2-D-7-O-I-MIDI		
		0.5 ... 12 bar	3,500 l/min		194645	LRS-1/2-D-O-I-MIDI		
	G3/4	0.5 ... 7 bar	4,500 l/min		194655	LRS-3/4-D-7-O-I-MIDI		
		0.5 ... 12 bar	3,500 l/min		194653	LRS-3/4-D-O-I-MIDI		
	Mini	G1/8	0.5 ... 7 bar		1,000 l/min	450 g	194609	LRS-1/8-D-7-O-I-MINI
			0.5 ... 12 bar		800 l/min		194605	LRS-1/8-D-O-I-MINI
G1/4		0.5 ... 7 bar	1,600 l/min	194617	LRS-1/4-D-7-O-I-MINI			
		0.5 ... 12 bar	1,500 l/min	194613	LRS-1/4-D-O-I-MINI			
G3/8		0.5 ... 7 bar	1,800 l/min	194625	LRS-3/8-D-7-O-I-MINI			
		0.5 ... 12 bar	1,700 l/min	194621	LRS-3/8-D-O-I-MINI			

**Pressure regulator, lockable LRS – directly actuated pressure regulator with integrated reverse flow function, rotary knob with latch, connecting plates with threaded connection (with pressure gauge, outer scale in bar, inner scale in psi)**

Size	Pneumatic connection, port 1	Pressure regulation range	Standard nominal flow rate (standardised to DIN 1343)	Product weight	Part no.	Type
Maxi	G1/2	0.5 ... 7 bar	7,300 l/min	1,680 g	194672	LRS-1/2-D-7-DI-MAXI
		0.5 ... 12 bar	5,400 l/min		194670	LRS-1/2-D-DI-MAXI
	G3/4	0.5 ... 7 bar	8,350 l/min		194676	LRS-3/4-D-7-DI-MAXI
		0.5 ... 12 bar	6,800 l/min		194674	LRS-3/4-D-DI-MAXI
	G1	0.5 ... 7 bar	8,400 l/min		194680	LRS-1-D-7-DI-MAXI
		0.5 ... 12 bar	7,000 l/min		194678	LRS-1-D-DI-MAXI

**Pressure regulator, lockable LRS – directly actuated with integrated reverse flow function, rotary knob with latch, connecting plates with threaded connection (without pressure gauge)**

Size	Pneumatic connection, port 1	Pressure regulation range	Standard nominal flow rate (standardised to DIN 1343)	Product weight	Part no.	Type
Maxi	G1/2	0.5 ... 7 bar	7,300 l/min	1,610 g	194673	LRS-1/2-D-7-O-DI-MAXI
		0.5 ... 12 bar	5,400 l/min		194671	LRS-1/2-D-O-DI-MAXI
	G3/4	0.5 ... 7 bar	8,350 l/min		194677	LRS-3/4-D-7-O-DI-MAXI
		0.5 ... 12 bar	6,800 l/min		194675	LRS-3/4-D-O-DI-MAXI
	G1	0.5 ... 7 bar	8,400 l/min		194681	LRS-1-D-7-O-DI-MAXI
		0.5 ... 12 bar	7,000 l/min		194679	LRS-1-D-O-DI-MAXI

## Peripherals

### Pressure regulator LR

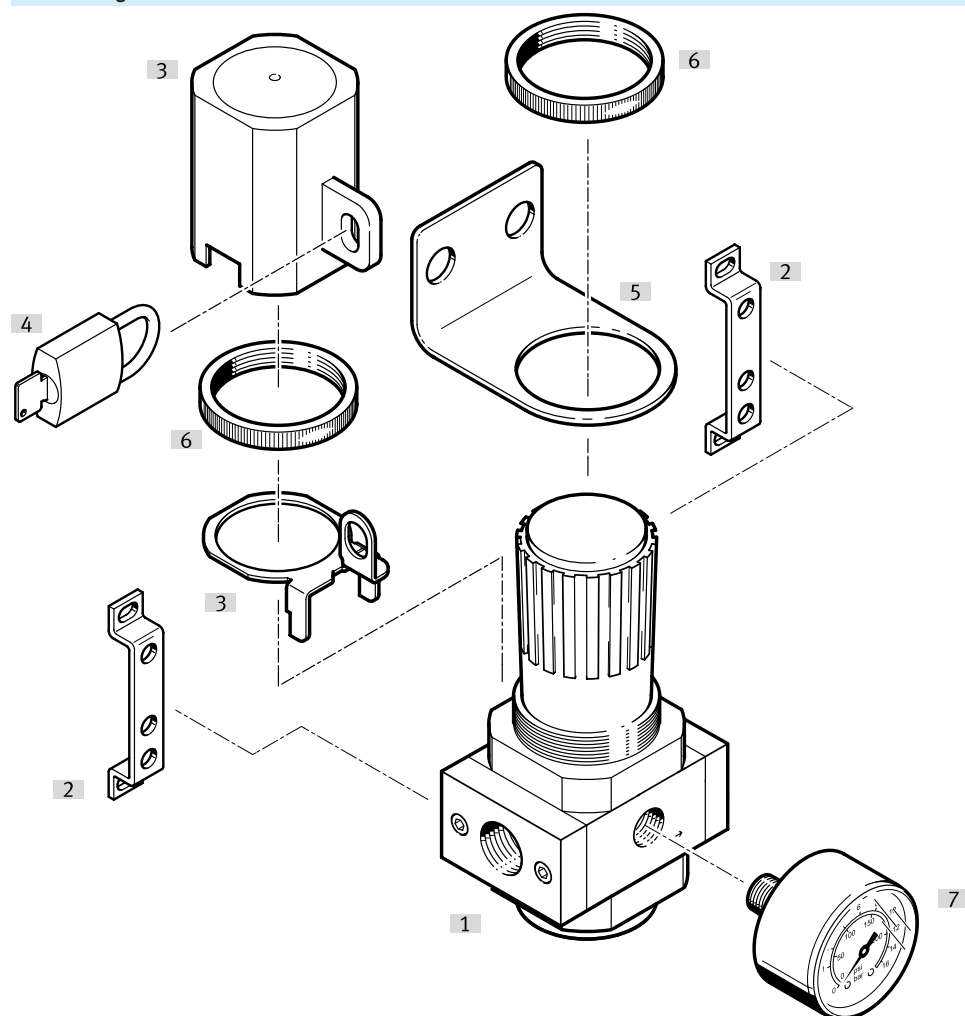

Accessories		→ Link
Type/order code	Description	
[1] Pressure regulator LR		<a href="#">lr</a>
[2] Mounting bracket HFOE		<a href="#">15</a>
[3] Regulator lock LRVS		<a href="#">15</a>
[4] Padlock LRVS-D		<a href="#">15</a>
[5] Mounting bracket HR-D		<a href="#">15</a>
[6] Knurled nut HMR	Included in the scope of delivery	<a href="#">-</a>
[7] Pressure gauge MA		<a href="#">15</a>

## Peripherals

### Pressure regulator LRS, lockable

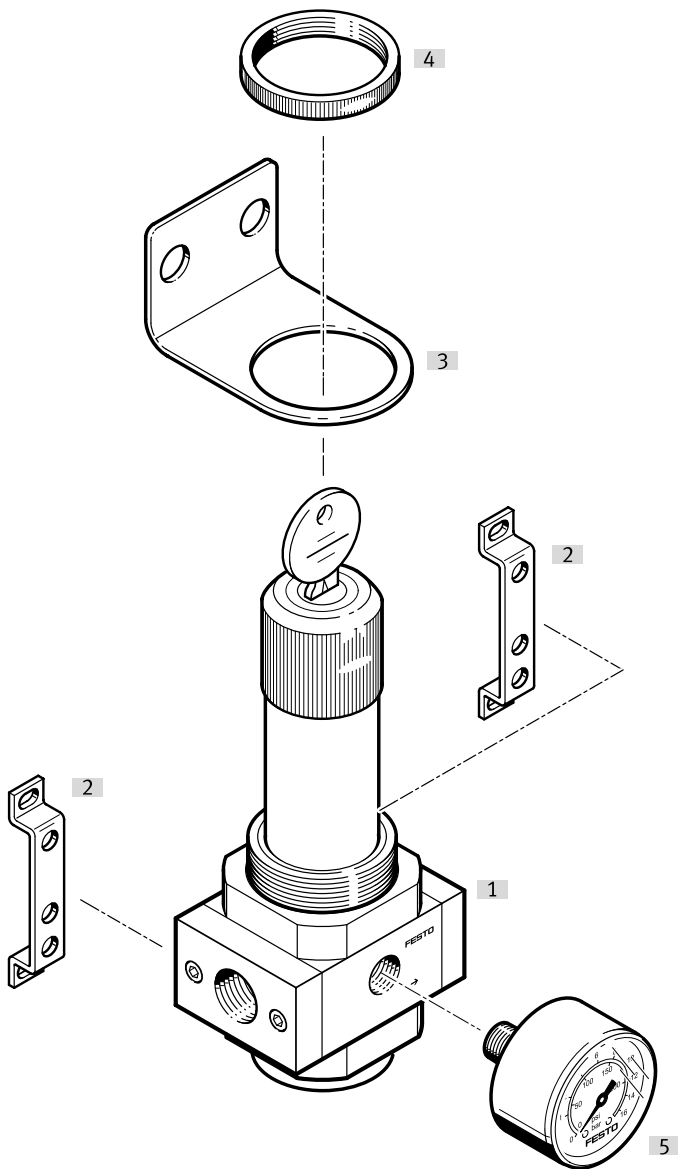

Accessories		→ Link
Type/order code	Description	
[1] Pressure regulator LRS		<a href="#">lrs</a>
[2] Mounting bracket HFOE		<a href="#">15</a>
[3] Mounting bracket HR-D		<a href="#">15</a>
[4] Knurled nut HMR	Included in the scope of delivery	<a href="#">-</a>
[5] Pressure gauge MA		<a href="#">15</a>

## Accessories

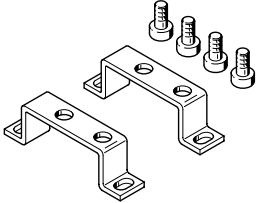
Mounting bracket HFOE					
	Corrosion resistance class CRC <sup>1)</sup>	LABS (PWIS) conformity	Part no.	Type	
	2 - Moderate corrosion stress	VDMA24364-B2-L	159593	HFOE-D-MIDI/MAXI	
		VDMA24364-B1/B2-L	159638	HFOE-D-MINI	

1) More information: [www.festo.com/x/topic/kbk](http://www.festo.com/x/topic/kbk)

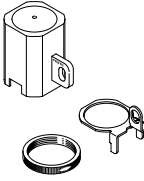
Regulator lock LRVS					
	LABS (PWIS) conformity	Product weight	Part no.	Type	
	VDMA24364-B1/B2-L	36 g	193784	LRVS-D-DI-MAXI	
		40 g	193781	LRVS-D-MINI	
		56 g	193783	LRVS-D-MAXI	
		60 g	193782	LRVS-D-MIDI	

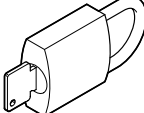
Padlock LRVS-D						
	Corrosion resistance class CRC <sup>1)</sup>	LABS (PWIS) conformity	Note on materials	Product weight	Part no.	Type
	2 - Moderate corrosion stress	VDMA24364-B1/B2-L	RoHS-compliant	120 g	193786	LRVS-D

1) More information: [www.festo.com/x/topic/kbk](http://www.festo.com/x/topic/kbk)

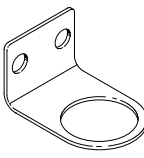
Mounting bracket HR-D					
	Corrosion resistance class CRC <sup>1)</sup>	LABS (PWIS) conformity	Part no.	Type	
	1 - Low corrosion stress	VDMA24364-B1/B2-L	164936	HR-D-MINI	
	2 - Moderate corrosion stress		162804	HR-D-MIDI	
			162805	HR-D-MAXI	
			193802	HR-D-DI-MAXI	

1) More information: [www.festo.com/x/topic/kbk](http://www.festo.com/x/topic/kbk)

Pressure gauge MA						
	Nominal size of pressure gauge	Pneumatic connection	Scale	Product weight	Part no.	Type
	40	G1/8	Double scale, Bar (outside scale), psi (inner scale)	60 g	345395	MA-40-16-1/8
					359874	MA-40-10-1/8
			Single scale, MPa (outer scale)	192733	MA-40-1,6-G1/8-MPA	
				192732	MA-40-1-G1/8-MPA	
		G1/4	Double scale, psi (inner scale), Bar (outside scale)	80 g	159596	FMA-40-10-1/4-EN
			Double scale, Bar (outside scale), psi (inner scale)	70 g	183900	MA-40-10-G1/4-EN

## Accessories

### Pressure gauge MA

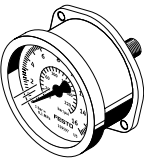
	Nominal size of pressure gauge	Pneumatic connection	Scale	Product weight	Part no.	Type
	40	G1/4	Double scale, Bar (outside scale), psi (inner scale)	80 g	159597	FMA-40-16-1/4-EN
		R1/8		60 g	162835	MA-40-10-1/8-EN
	50	G1/4		70 g	356759	MA-50-16-1/4
					359873	MA-50-10-1/4
			100 g	159600	FMA-50-16-1/4-EN	
				159599	FMA-50-10-1/4-EN	
			Single scale, MPa (outer scale)	70 g	192734	MA-50-1-G1/4-MPA
					192735	MA-50-1,6-G1/4-MPA

### Pressure sensor SPAU for direct mounting on the service unit component with pressure gauge connection (adapter for pneumatic connection included in the scope of delivery)

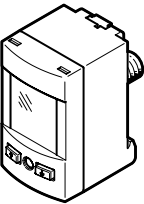
	Pneumatic connection	Switching output	Display type	Electrical connection 1, connector system	Part no.	Type
	R1/8	2 x PNP or 2 x NPN, switchable	Illuminated LCD	M12x1, A-coded to EN 61076-2-101	8001206	SPAU-P10R-T-R18M-L-PNLK-PNVBA-M12D
				M8x1, A-coded, to EN 61076-2-104	8001203	SPAU-P10R-T-R18M-L-PNLK-PNVBA-M8D
	R1/4	M12x1, A-coded to EN 61076-2-101		8001208	SPAU-P10R-T-R14M-L-PNLK-PNVBA-M12D	
		M8x1, A-coded, to EN 61076-2-104		8001209	SPAU-P10R-T-R14M-L-PNLK-PNVBA-M8D	

### Push-in fitting QSF, female thread with external hex

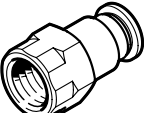
	Pneumatic connection, port 1	Pneumatic connection, port 2	Product weight	Part no.	Type
	Female thread G1/4	For tubing outside diameter of 8 mm	24 g	★ 153026	QSF-1/4-8-B

### Push-in T-fitting QSTF, rotatable 360°, with female and male thread

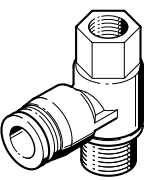
	Pneumatic connection, port 1	Pneumatic connection, port 2	Product weight	Part no.	Type
	Male thread G1/4	Female thread G1/4, For tubing outside diameter of 8 mm	44 g	186203	QSTF-G1/4-8

### Push-in Y-fitting QSylv, rotatable 360°, male thread with external hex

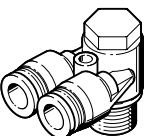
	Pneumatic connection, port 1	Pneumatic connection, port 2	Product weight	Part no.	Type
	Male thread G1/4	For tubing outside diameter of 8 mm	48 g	186210	QSylv-G1/4-8