

## Service unit combination without lubricator LFR

**FESTO**



## Characteristics

### At a glance

Service units for unlubricated compressed air supply.

- Rotary knob with latch
- Pressure gauge with outer scale in bar and inner scale in psi
- Mounting bracket included in the scope of delivery

### Service unit combination

[KA] Filter regulator, branching module

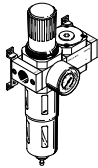

Three connections are available

[KB] Filter regulator, branching module, on/off valve manually operated

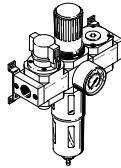

The operating pressure can be switched on or off.

Three connections are available

An additional quick exhaust valve is required at the service unit outlet for safe exhausting of the system

[KC] On/off valve manually operated, filter regulator

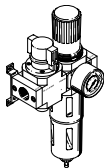

The operating pressure can be switched on or off.

An additional quick exhaust valve is required at the service unit outlet for safe exhausting of the system

[KD] Filter regulator, on/off valve electrically operated, 24 V DC, soft-start valve pneumatically operated

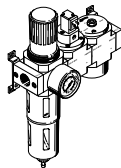

When the unit is switched off, quick exhausting ensures rapid pressure reduction  
Gradual pressure build-up prevents sudden, unpredictable movements

[KE] Filter regulator, branching module, soft-start valve pneumatically operated

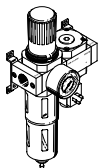

Two connections are available.

Electrical pressure monitoring with adjustable switching pressure

[KF] On/off valve manually operated, filter regulator, branching module with pressure switch

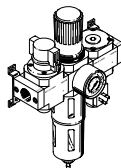

The operating pressure can be switched on or off.

Two connections are available.

Electrical pressure monitoring with adjustable switching pressure

An additional quick exhaust valve is required at the service unit outlet for safe exhausting of the system

## Characteristics

[KG] On/off valve manually operated, filter regulator, on/off valve electrically operated, 24 V DC, soft-start valve pneumatically operated, branching module with pressure switch

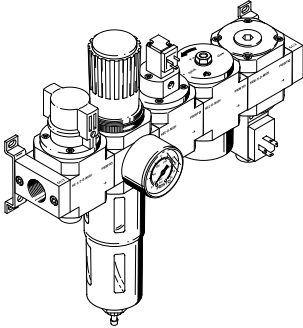

Two connections are available.

Gradual pressure build-up prevents sudden, unpredictable movements

Electrical pressure monitoring with adjustable switching pressure

An additional quick exhaust valve is required at the service unit outlet for safe exhausting of the system

## Type code

001		Series
LFR		Filter regulator
002		Pneumatic connection
1/8		Female thread G1/8
1/4		Female thread G1/4
3/8		Female thread G3/8
1/2		Female thread G1/2
3/4		Female thread G3/4
003		Version
D		D series, metal
004		Function
		Directly actuated pressure regulator (MICRO, MINI, MIDI), pilot actuated pressure regulator (only MAXI)
DI		Directly actuated pressure regulator with integrated return flow function (only MAXI)

005		Size
MINI		Grid dimension 40 mm (without connecting plates)
MIDI		Grid dimension 55 mm (without connecting plates)
MAXI		Grid dimension 66 mm (without connecting plates)
006		Service unit combination
KB		Filter regulator, branching module, on/off valve manually operated
KA		Filter regulator, branching module
KC		On/off valve manually operated, filter regulator
KG		On/off valve manually operated, filter regulator, on/off valve electrically operated, 24 V DC, soft-start valve pneumatically operated, branching module with pressure switch
KF		On/off valve manually operated, filter regulator, branching module with pressure switch
KE		Filter regulator, branching module, soft-start valve pneumatically operated
KD		Filter regulator, on/off valve electrically operated, 24 V DC, soft-start valve pneumatically operated
007		Condensate drain
		Manually rotating
A		Fully automatic

## Datasheet

Technical data LFR-...-KA							
Size	Maxi			Midi		Mini	
Pneumatic connection, port 1	G1/2	G3/4	G1/4	G3/8	G1/2	G1/8	G1/4
Pneumatic connection, port 2	G1/2	G3/4	G1/4	G3/8	G1/2	G1/8	G1/4
Type of mounting	Either: In-line installation With accessories						
Mounting position	Vertical +/-5°						
Grade of filtration	40 µm						
Air purity class at output	Compressed air to ISO 8573-1:2010 [6:8:4] Compressed air to ISO 8573-1:2010 [7:8:4] Inert gases			Compressed air to ISO 8573-1:2010 [7:8:4] Inert gases			
Bowl guard	Metal bowl guard						
Condensate drain	Fully automatic Manually rotating						
Actuator lock	Rotary knob with detent						
Pressure regulation range	0.05 ... 1.2 MPa						
Pressure regulation range	0.5 ... 12 bar						
Pressure regulation range	7.25 ... 174 psi						
Max. pressure hysteresis	0.02 MPa	0.03 MPa	0.025 MPa	0.02 MPa	0.015 MPa		
Max. pressure hysteresis	0.2 bar	0.3 bar	0.25 bar	0.2 bar	0.15 bar		
Max. pressure hysteresis	2.9 psi	4.35 psi	3.625 psi	2.9 psi	2.175 psi		
Pressure gauge (ANALOG) or Pressure display (DIGITAL)	With pressure gauge						
Max. condensate volume <sup>1)</sup>	43 cm <sup>3</sup> ; 80 cm <sup>3</sup>			43 cm <sup>3</sup>		22 cm <sup>3</sup>	
Standard nominal flow rate (standardised to DIN 1343) <sup>2)</sup>	5,200 l/min 9,200 l/min	5,800 l/min 9,400 l/min	1,850 l/min	2,620 l/min	3,050 l/min	720 l/min	1,140 l/min
Operating pressure	0.1 ... 1.6 MPa						
Operating pressure	1 ... 16 bar						
Operating pressure	14.5 ... 232 psi						
Operating medium	Compressed air to ISO 8573-1:2010 [:-:-] Inert gases						
Ambient temperature	-10 ... 60°C						
Media temperature	-10 ... 60°C						
Corrosion resistance class CRC <sup>3)</sup>	2 - Moderate corrosion stress						
LABS (PWIS) conformity <sup>4)</sup>	VDMA24364-B1/B2-L						

1) Low value: LFR-...-D-DI

2) Low value: LFR-...-D-DI

3) More information: visit [www.festo.com/x/topic/kbk](http://www.festo.com/x/topic/kbk)

4) Additional material specifications → datasheet for the individual devices

## Function LFR-...-MINI/MIDI-KA (condensate drain, manual, rotating)

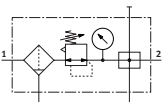

## Function LFR-...-MAXI-KA (with condensate drain, manual, rotating)

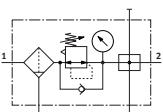

Datasheet

Standard flow rate  $q_n$  as a function of output pressure  $p_2$  ( $p_1 = 10$  bar) – LFR-1/2-D-DI-MAXI-KA(-A)

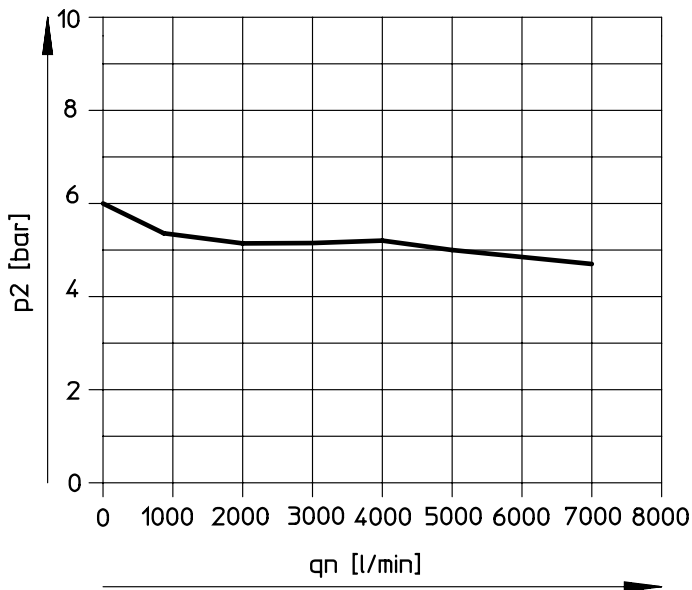

Technical data LFR-...-KB

Size	Maxi		Midi			Mini	
Pneumatic connection, port 1	G1/2	G3/4	G1/4	G3/8	G1/2	G1/8	G1/4
Pneumatic connection, port 2	G1/2	G3/4	G1/4	G3/8	G1/2	G1/8	G1/4
Type of mounting	Either: In-line installation With accessories						
Mounting position	Vertical +/-5°						
Grade of filtration	40 µm						
Air purity class at output	Compressed air to ISO 8573-1:2010 [6:8:4] Compressed air to ISO 8573-1:2010 [7:8:4] Inert gases		Compressed air to ISO 8573-1:2010 [7:8:4] Inert gases				
Bowl guard	Metal bowl guard						
Condensate drain	Fully automatic Manually rotating						
Actuator lock	Rotary knob with detent						
Pressure regulation range	0.05 ... 1.2 MPa						
Pressure regulation range	0.5 ... 12 bar						
Pressure regulation range	7.25 ... 174 psi						
Max. pressure hysteresis	0.01 MPa	0.02 MPa	0.025 MPa	0.035 MPa	0.02 MPa		
Max. pressure hysteresis	0.1 bar	0.2 bar	0.25 bar	0.35 bar	0.2 bar		
Max. pressure hysteresis	1.45 psi	2.9 psi	3.625 psi	5.075 psi	2.9 psi		
Pressure gauge (ANALOG) or Pressure display (DIGITAL)	With pressure gauge						
Max. condensate volume	43 cm³; 80 cm³		43 cm³			22 cm³	
Standard nominal flow rate (standardised to DIN 1343)	5,400 l/min 8,000 l/min	7,000 l/min 8,400 l/min	1,720 l/min	2,420 l/min	2,920 l/min	700 l/min	1,050 l/min
Operating pressure	0.1 ... 1.6 MPa						
Operating pressure	1 ... 16 bar						
Operating pressure	14.5 ... 232 psi						
Operating medium	Compressed air to ISO 8573-1:2010 [:-:-] Inert gases						
Ambient temperature	-10 ... 60°C						
Media temperature	-10 ... 60°C						
Corrosion resistance class CRC	2 - Moderate corrosion stress						
LABS (PWIS) conformity	VDMA24364-B1/B2-L						

## Datasheet

## Function LFR-...-MINI/MIDI-KB (with condensate drain, manual, rotating)

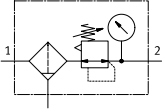

## Function LFR-...-MAXI-KB (with condensate drain, manual, rotating)

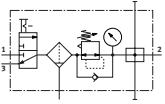
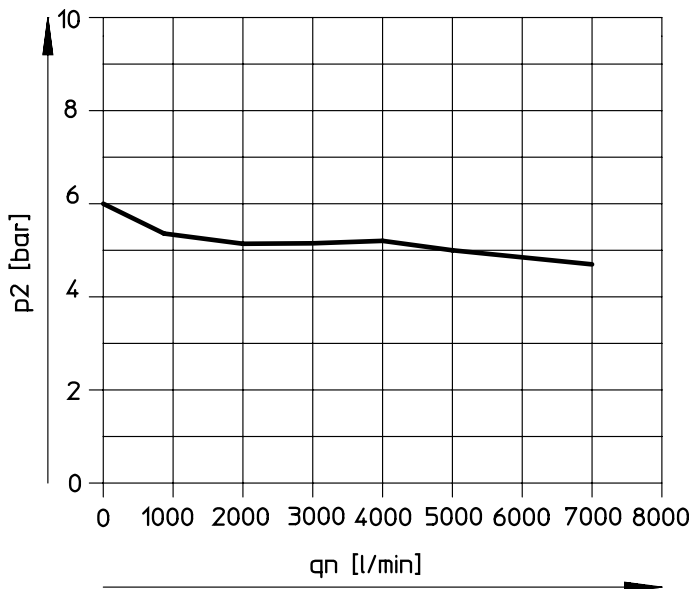
Standard flow rate  $q_n$  as a function of output pressure  $p_2$  ( $p_1 = 10$  bar) – LFR-1/2-D-DI-MAXI-KB(-A)

## Datasheet

Technical data LFR-...-KC								
Size	Maxi			Midi			Mini	
Pneumatic connection, port 1	G1/2	G3/4	G1/4	G3/8	G1/2	G1/8	G1/4	
Pneumatic connection, port 2	G1/2	G3/4	G1/4	G3/8	G1/2	G1/8	G1/4	
Type of mounting	Either: In-line installation With accessories							
Mounting position	Vertical +/-5°							
Grade of filtration	40 µm							
Air purity class at output	Compressed air to ISO 8573-1:2010 [6:8:4] Compressed air to ISO 8573-1:2010 [7:8:4] Inert gases			Compressed air to ISO 8573-1:2010 [7:8:4] Inert gases				
Bowl guard	Metal bowl guard							
Condensate drain	Fully automatic Manually rotating							
Actuator lock	Rotary knob with detent							
Pressure regulation range	0.05 ... 1.2 MPa							
Pressure regulation range	0.5 ... 12 bar							
Pressure regulation range	7.25 ... 174 psi							
Max. pressure hysteresis	0.02 MPa							
Max. pressure hysteresis	0.2 bar							
Max. pressure hysteresis	2.9 psi							
Pressure gauge (ANALOG) or Pressure display (DIGITAL)	With pressure gauge							
Max. condensate volume <sup>1)</sup>	43 cm <sup>3</sup> ; 80 cm <sup>3</sup>			43 cm <sup>3</sup>			22 cm <sup>3</sup>	
Standard nominal flow rate (standardised to DIN 1343) <sup>2)</sup>	4,800 l/min 8,100 l/min	5,400 l/min 8,400 l/min	1,900 l/min	2,700 l/min	3,150 l/min	750 l/min	1,150 l/min	
Operating pressure	0.1 ... 1.6 MPa							
Operating pressure	1 ... 16 bar							
Operating pressure	14.5 ... 232 psi							
Operating medium	Compressed air to ISO 8573-1:2010 [:-:-] Inert gases							
Ambient temperature	-10 ... 60°C							
Media temperature	-10 ... 60°C							
Corrosion resistance class CRC <sup>3)</sup>	2 - Moderate corrosion stress							
LABS (PWIS) conformity <sup>4)</sup>	VDMA24364-B1/B2-L							

1) Low value: LFR-...-D-DI

2) Low value: LFR-...-D-DI

3) More information: visit [www.festo.com/x/topic/kbk](http://www.festo.com/x/topic/kbk)

4) Additional material specifications → datasheet for the individual devices

### Function LFR-...-MINI/MIDI-KC (condensate drain, manual, rotating)

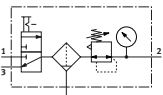

### Function LFR-...-MAXI-KC (with condensate drain, manual, rotating)

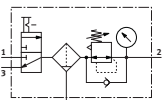

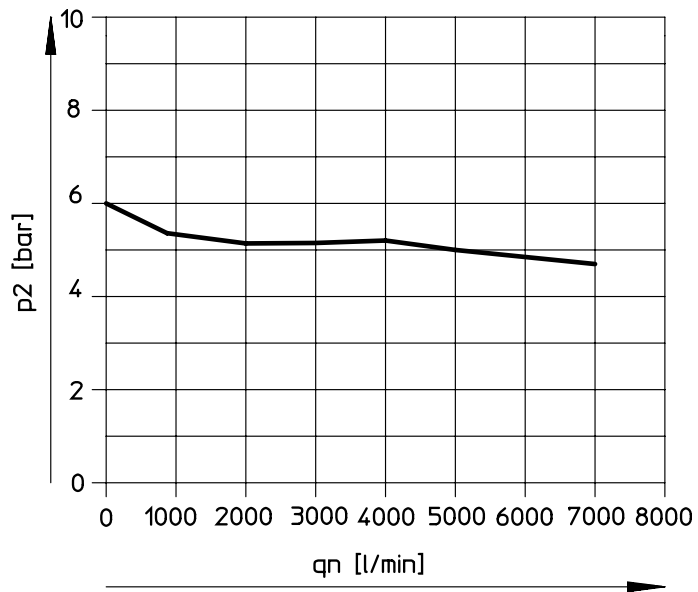

## Datasheet

Standard flow rate  $q_n$  as a function of output pressure  $p_2$  ( $p_1 = 10$  bar) – LFR-1/2-D-DI-MAXI-KC(-A)

## Datasheet

Technical data LFR-...-KD								
Size	Maxi			Midi			Mini	
Pneumatic connection, port 1	G1/2	G3/4	G1/4	G3/8	G1/2	G1/8	G1/4	
Pneumatic connection, port 2	G1/2	G3/4	G1/4	G3/8	G1/2	G1/8	G1/4	
Type of mounting	Either: In-line installation With accessories							
Mounting position	Vertical +/-5°							
Grade of filtration	40 µm							
Air purity class at output	Compressed air to ISO 8573-1:2010 [6:8:4] Compressed air to ISO 8573-1:2010 [7:8:4] Inert gases			Compressed air to ISO 8573-1:2010 [7:8:4] Inert gases				
Bowl guard	Metal bowl guard							
Condensate drain	Fully automatic Manually rotating							
Actuator lock	Rotary knob with detent							
Pressure regulation range	0.25 ... 1.2 MPa							
Pressure regulation range	2.5 ... 12 bar							
Pressure regulation range	36.25 ... 174 psi							
Max. pressure hysteresis	0.03 MPa	0.02 MPa	0.025 MPa			0.015 MPa		
Max. pressure hysteresis	0.3 bar	0.2 bar	0.25 bar			0.15 bar		
Max. pressure hysteresis	4.35 psi	2.9 psi	3.625 psi			2.175 psi		
Pressure gauge (ANALOG) or Pressure display (DIGITAL)	With pressure gauge							
Max. condensate volume <sup>1)</sup>	43 cm <sup>3</sup> ; 80 cm <sup>3</sup>			43 cm <sup>3</sup>			22 cm <sup>3</sup>	
Standard nominal flow rate (standardised to DIN 1343) <sup>2)</sup>	3,000 l/min 4,300 l/min	2,800 l/min 5,000 l/min	1,440 l/min	1,890 l/min	2,000 l/min	595 l/min	730 l/min	
Operating pressure	0.3 ... 1.6 MPa							
Operating pressure	3 ... 16 bar							
Operating pressure	43.5 ... 232 psi							
Operating medium	Compressed air to ISO 8573-1:2010 [:-:-] Inert gases							
Ambient temperature	-10 ... 60°C							
Media temperature	-10 ... 60°C							
Corrosion resistance class CRC <sup>3)</sup>	2 - Moderate corrosion stress							
LABS (PWIS) conformity <sup>4)</sup>	VDMA24364-B1/B2-L							

1) Low value: LFR-...-D-DI

2) Low value: LFR-...-D-DI

3) More information: visit [www.festo.com/x/topic/kbk](http://www.festo.com/x/topic/kbk)

4) Additional material specifications → datasheet for the individual devices

### Function LFR-...-MINI/MIDI-KD (with condensate drain, manual, rotating)

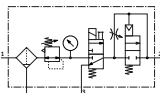

### Function LFR-...-MAXI-KD (with condensate drain, manual, rotating)

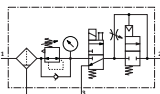

## Datasheet

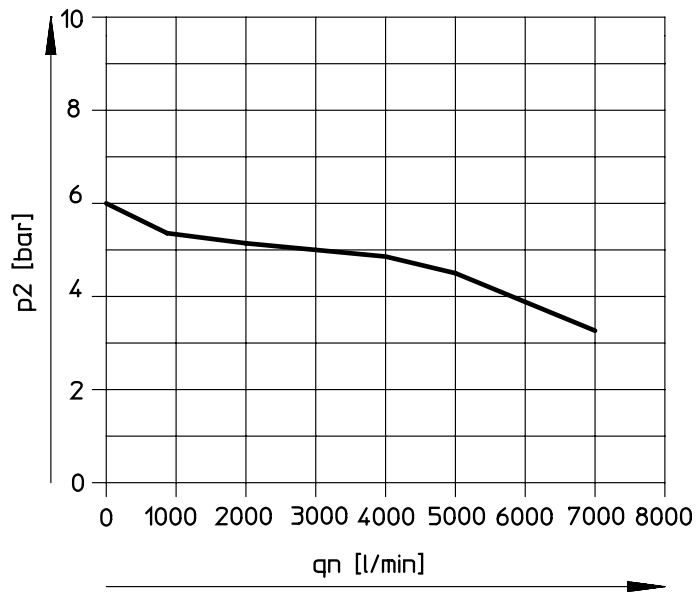
Standard flow rate  $q_n$  as a function of output pressure  $p_2$  ( $p_1 = 10$  bar) – LFR-1/2-D-DI-MAXI-KA(-A)

## Datasheet

Technical data LFR-...-KE								
Size	Maxi			Midi			Mini	
Pneumatic connection, port 1	G1/2	G3/4	G1/4	G3/8	G1/2	G1/8	G1/4	
Pneumatic connection, port 2	G1/2	G3/4	G1/4	G3/8	G1/2	G1/8	G1/4	
Type of mounting	Either: In-line installation With accessories							
Mounting position	Vertical +/-5°							
Grade of filtration	40 µm							
Air purity class at output	Compressed air to ISO 8573-1:2010 [6:8:4] Compressed air to ISO 8573-1:2010 [7:8:4] Inert gases			Compressed air to ISO 8573-1:2010 [7:8:4] Inert gases				
Bowl guard	Metal bowl guard							
Condensate drain	Fully automatic Manually rotating							
Actuator lock	Rotary knob with detent							
Pressure regulation range	0.05 ... 1.2 MPa							
Pressure regulation range	0.5 ... 12 bar							
Pressure regulation range	7.25 ... 174 psi							
Max. pressure hysteresis	0.02 MPa	0.03 MPa	0.025 MPa	0.02 MPa	0.015 MPa			
Max. pressure hysteresis	0.2 bar	0.3 bar	0.25 bar	0.2 bar	0.15 bar			
Max. pressure hysteresis	2.9 psi	4.35 psi	3.625 psi	2.9 psi	2.175 psi			
Pressure gauge (ANALOG) or Pressure display (DIGITAL)	With pressure gauge							
Max. condensate volume <sup>1)</sup>	43 cm <sup>3</sup> ; 80 cm <sup>3</sup>			43 cm <sup>3</sup>			22 cm <sup>3</sup>	
Standard nominal flow rate (standardised to DIN 1343) <sup>2)</sup>	9,200 l/min	6,000 l/min 9,400 l/min	1,850 l/min	2,620 l/min	3,050 l/min	720 l/min	1,140 l/min	
Operating pressure	0.1 ... 1.6 MPa							
Operating pressure	1 ... 16 bar							
Operating pressure	14.5 ... 232 psi							
Operating medium	Compressed air to ISO 8573-1:2010 [:-:-] Inert gases							
Ambient temperature	-10 ... 60°C							
Media temperature	-10 ... 60°C							
Corrosion resistance class CRC <sup>3)</sup>	2 - Moderate corrosion stress							
LABS (PWIS) conformity <sup>4)</sup>	VDMA24364-B1/B2-L							

1) Low value: LFR-...-D-DI

2) Low value: LFR-...-D-DI

3) More information: visit [www.festo.com/x/topic/kbk](http://www.festo.com/x/topic/kbk)

4) Additional material specifications → datasheet for the individual devices

### Function LFR-...-MINI/MIDI-KE (with condensate drain, manual, rotating)

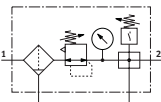

### Function LFR-...-MAXI-KE (with condensate drain, manual, rotating)

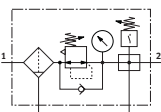

## Datasheet

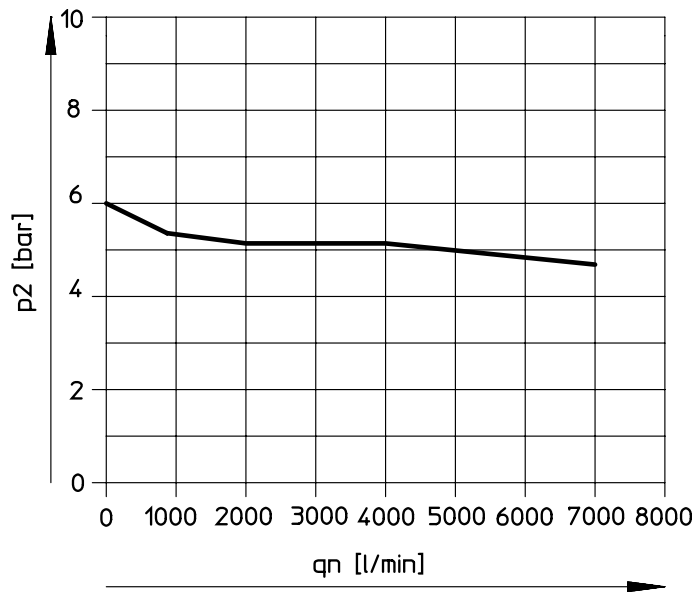
Standard flow rate  $q_n$  as a function of output pressure  $p_2$  ( $p_1 = 10$  bar) – LFR-1/2-D-DI-MAXI-KE(-A)

## Datasheet

Technical data LFR-...-KF								
Size	Maxi			Midi			Mini	
Pneumatic connection, port 1	G1/2	G3/4	G1/4	G3/8	G1/2	G1/8	G1/4	
Pneumatic connection, port 2	G1/2	G3/4	G1/4	G3/8	G1/2	G1/8	G1/4	
Type of mounting	Either: In-line installation With accessories							
Mounting position	Vertical +/-5°							
Grade of filtration	40 µm							
Air purity class at output	Compressed air to ISO 8573-1:2010 [6:8:4] Compressed air to ISO 8573-1:2010 [7:8:4] Inert gases			Compressed air to ISO 8573-1:2010 [7:8:4] Inert gases				
Bowl guard	Metal bowl guard							
Condensate drain	Fully automatic Manually rotating							
Actuator lock	Rotary knob with detent							
Pressure regulation range	0.05 ... 1.2 MPa							
Pressure regulation range	0.5 ... 12 bar							
Pressure regulation range	7.25 ... 174 psi							
Max. pressure hysteresis	0.02 MPa		0.025 MPa	0.03 MPa	0.025 MPa	0.02 MPa		
Max. pressure hysteresis	0.2 bar		0.25 bar	0.3 bar	0.25 bar	0.2 bar		
Max. pressure hysteresis	2.9 psi		3.625 psi	4.35 psi	3.625 psi	2.9 psi		
Pressure gauge (ANALOG) or Pressure display (DIGITAL)	With pressure gauge							
Max. condensate volume <sup>1)</sup>	43 cm <sup>3</sup> ; 80 cm <sup>3</sup>			43 cm <sup>3</sup>			22 cm <sup>3</sup>	
Standard nominal flow rate (standardised to DIN 1343) <sup>2)</sup>	8,000 l/min	6,000 l/min 8,400 l/min	1,720 l/min	2,420 l/min	2,920 l/min	700 l/min	1,050 l/min	
Operating pressure	0.1 ... 1.6 MPa							
Operating pressure	1 ... 16 bar							
Operating pressure	14.5 ... 232 psi							
Operating medium	Compressed air to ISO 8573-1:2010 [:-:-] Inert gases							
Ambient temperature	-10 ... 60°C							
Media temperature	-10 ... 60°C							
Corrosion resistance class CRC <sup>3)</sup>	2 - Moderate corrosion stress							
LABS (PWIS) conformity <sup>4)</sup>	VDMA24364-B1/B2-L							

1) Low value: LFR-...-D-DI

2) Low value: LFR-...-D-DI

3) More information: visit [www.festo.com/x/topic/kbk](http://www.festo.com/x/topic/kbk)

4) Additional material specifications → datasheet for the individual devices

### Function LFR-...-MINI/MIDI-KF (condensate drain, manual, rotating)

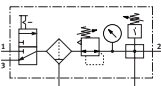

### Function LFR-...-MAXI-KF (with condensate drain, manual, rotating)

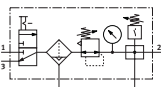

## Datasheet

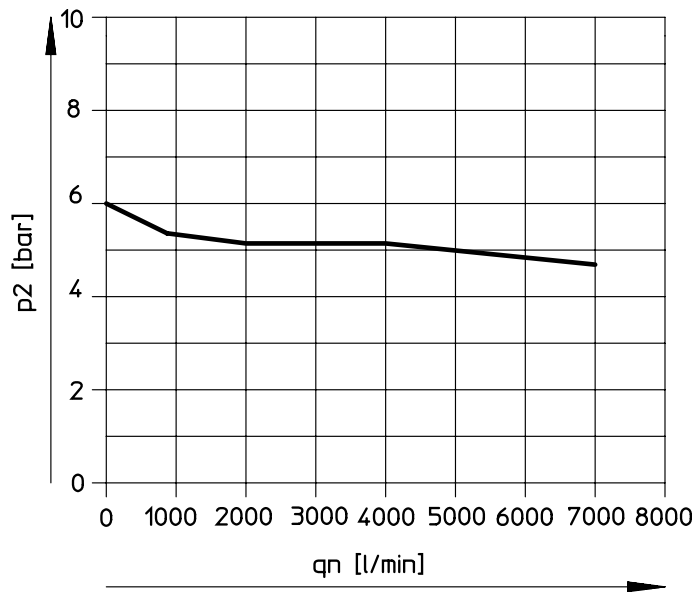
Standard flow rate  $q_n$  as a function of output pressure  $p_2$  ( $p_1 = 10$  bar) – LFR-1/2-D-DI-MAXI-KF(-A)

## Datasheet

Technical data LFR...-KG								
Size	Maxi			Midi			Mini	
Pneumatic connection, port 1	G1/2	G3/4	G1/4	G3/8	G1/2	G1/8	G1/4	
Pneumatic connection, port 2	G1/2	G3/4	G1/4	G3/8	G1/2	G1/8	G1/4	
Type of mounting	Either: In-line installation With accessories							
Mounting position	Vertical +/-5°							
Grade of filtration	40 µm							
Air purity class at output	Compressed air to ISO 8573-1:2010 [6:8:4] Compressed air to ISO 8573-1:2010 [7:8:4] Inert gases			Compressed air to ISO 8573-1:2010 [7:8:4] Inert gases				
Bowl guard	Metal bowl guard							
Condensate drain	Fully automatic Manually rotating							
Actuator lock	Rotary knob with detent							
Pressure regulation range	0.25 ... 1.2 MPa							
Pressure regulation range	2.5 ... 12 bar							
Pressure regulation range	36.25 ... 174 psi							
Max. pressure hysteresis	0.025 MPa			0.02 MPa		0.015 MPa		
Max. pressure hysteresis	0.25 bar			0.2 bar		0.15 bar		
Max. pressure hysteresis	3.625 psi			2.9 psi		2.175 psi		
Pressure gauge (ANALOG) or Pressure display (DIGITAL)	With pressure gauge							
Max. condensate volume <sup>1)</sup>	43 cm <sup>3</sup> ; 80 cm <sup>3</sup>			43 cm <sup>3</sup>			22 cm <sup>3</sup>	
Standard nominal flow rate (standardised to DIN 1343) <sup>2)</sup>	2,500 l/min 4,200 l/min	3,000 l/min 4,900 l/min	1,370 l/min	1,680 l/min	1,740 l/min	575 l/min	715 l/min	
Operating pressure	0.3 ... 1.6 MPa							
Operating pressure	3 ... 16 bar							
Operating pressure	43.5 ... 232 psi							
Operating medium	Compressed air to ISO 8573-1:2010 [:-:-] Inert gases							
Ambient temperature	-10 ... 60°C							
Media temperature	-10 ... 60°C							
Corrosion resistance class CRC <sup>3)</sup>	2 - Moderate corrosion stress							
LABS (PWIS) conformity <sup>4)</sup>	VDMA24364-B1/B2-L							

1) Low value: LFR...-D-DI

2) Low value: LFR...-D-DI

3) More information: visit [www.festo.com/x/topic/kbk](http://www.festo.com/x/topic/kbk)

4) Additional material specifications → datasheet for the individual devices

### Function LFR...-MINI/MIDI-KG (with condensate drain, manual, rotating)

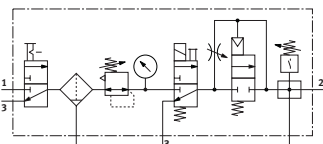

### Function LFR...-MAXI-KG (with condensate drain, manual, rotating)

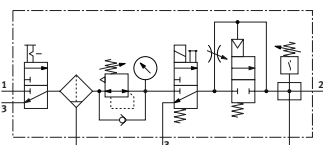

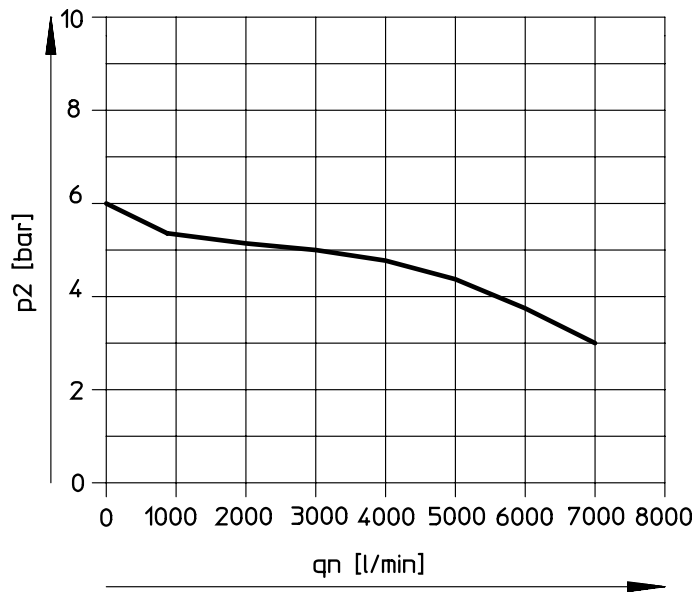

## Datasheet

Standard flow rate  $q_n$  as a function of output pressure  $p_2$  ( $p_1 = 10$  bar) – LFR-1/2-D-DI-MAXI-KG(-A)

## Dimensions

Dimensions – LFR-...-KA

Download CAD data [www.festo.com](http://www.festo.com)

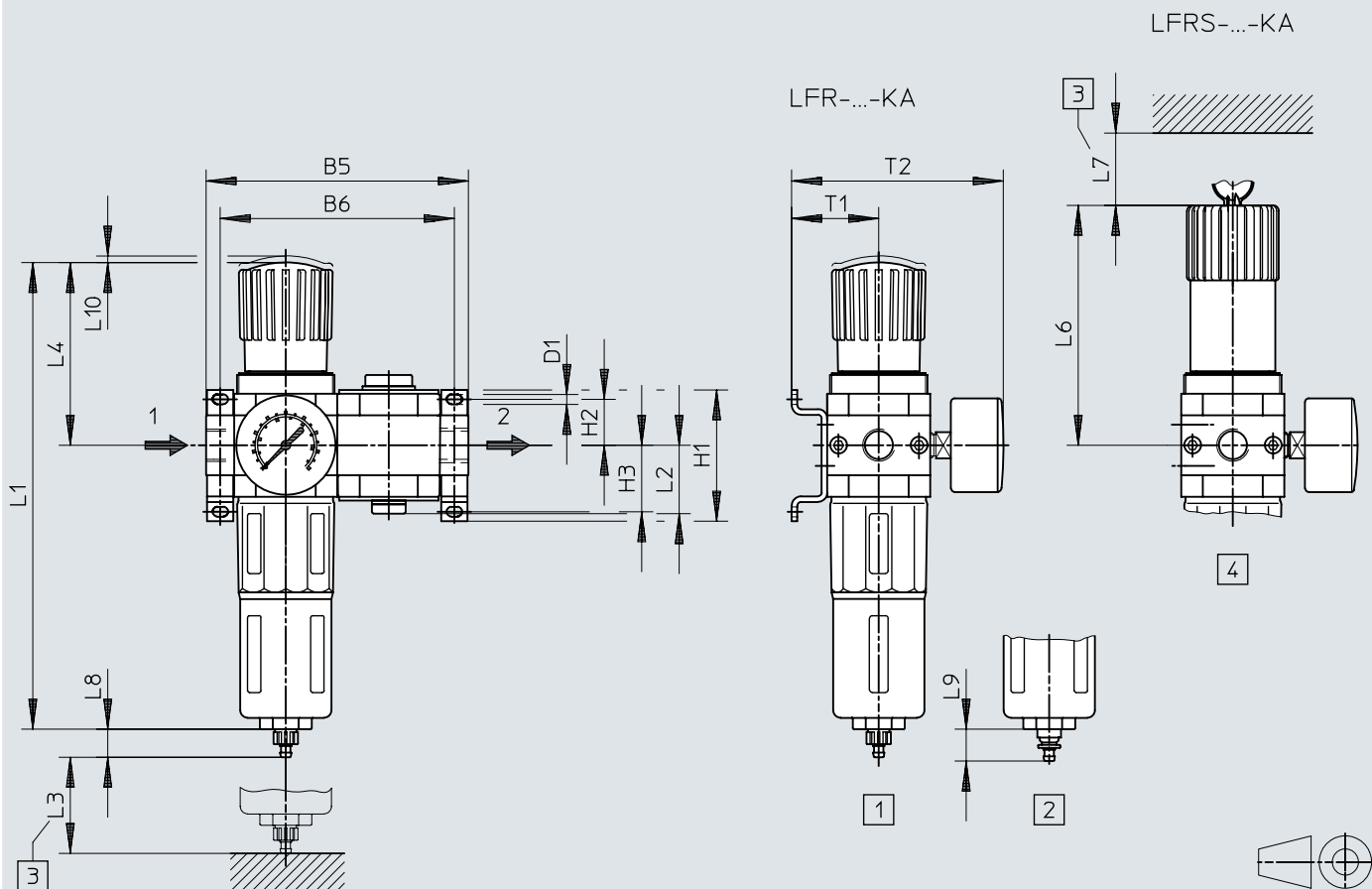

- [1] Manual condensate drain
- [2] Fully automatic condensate drain
- [3] Installation dimension
- [4] Lockable

	B5	B6	D1	H1	H2	H3	L1	L2	L3	L4	L6	L7	L8	L9	L10	T1	T2
LFR-...-D-MINI-KA (A)	104	92	4,3	43	17,5	17,5	193	28	60	68	98	60	15	19	3	39	95
LFR-...-D-MIDI-KA (A)	140	125	5,3	70	24,5	35,5	250	36,5	80	99	130	60	15	19	3	47	114
LFR-...-D-MAXI-KA (A)	162	146	5,3	70	24,5	35,5	252	42	90	82	111	60	15	19	3	53	126
LFR-...-D-DI-MAXI-KA (A)							275			105	135						

1) Note: This product complies with ISO 1179-1 and ISO 228-1.

# Dimensions

Dimensions – LFR...-KB

Download CAD data [www.festo.com](http://www.festo.com)

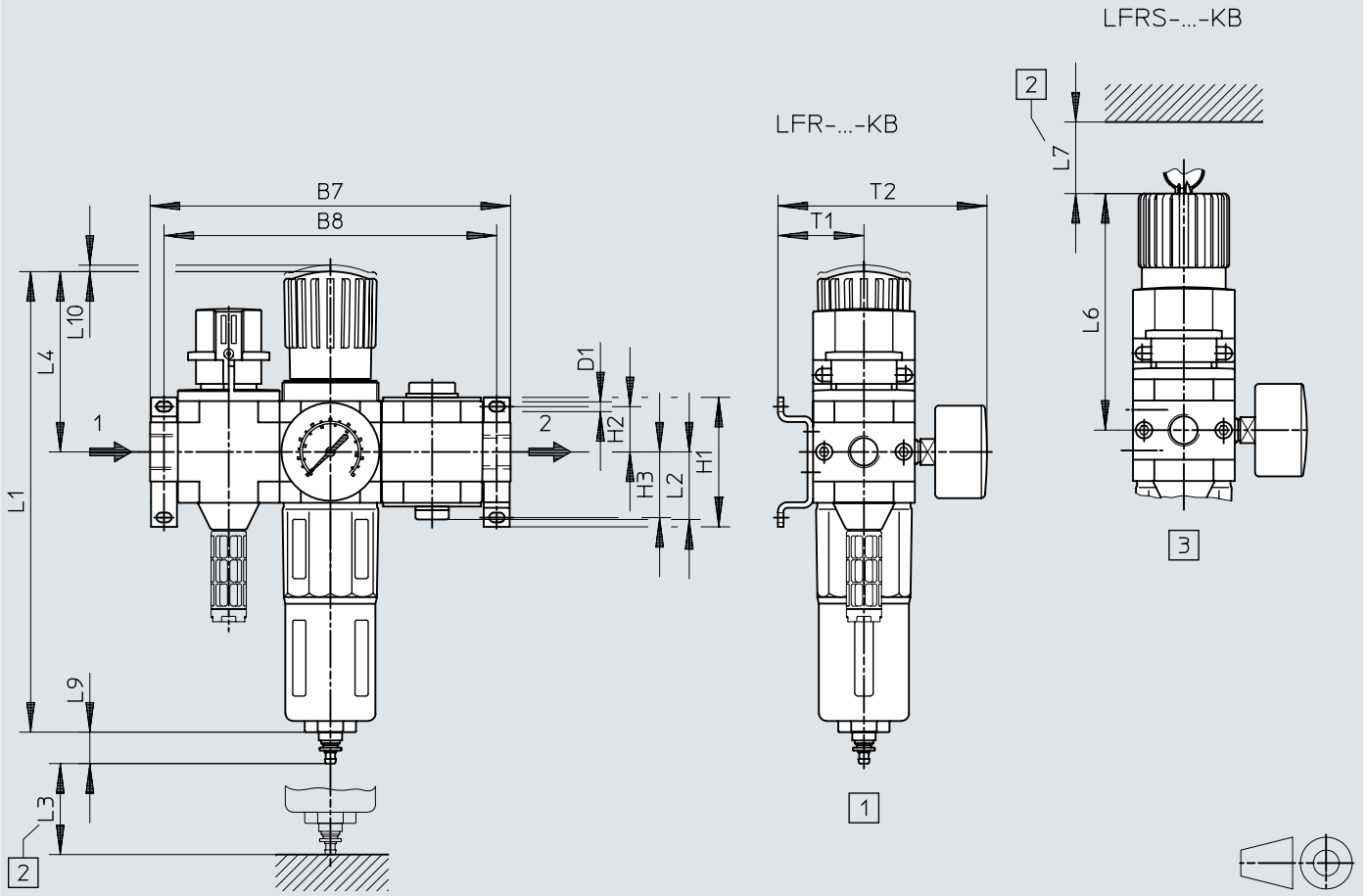

- [1] Condensate drain
- [2] Installation dimension
- [3] Lockable

	B7	B8	D1	H1	H2	H3	L1	L2	L3	L4	L6	L7	L9	L10	T1	T2
LFR...-D-MINI-KB (A)	144	132	4,3	43	17,5	17,5	193	28	60	68	98	60	19	3	39	95
LFR...-D-MIDI-KB (A)	195	180	5,3	70	24,5	35,5	250	36,5	80	99	130	60	19	3	47	114
LFR...-D-MAXI-KB (A)	228	212	5,3	70	24,5	35,5	252	42	90	82	111	60	19	3	53	126
LFR...-D-DI-MAXI-KB (A)							275			105	135					

1) Note: This product complies with ISO 1179-1 and ISO 228-1.

## Dimensions

Dimensions – LFR-...-KC

Download CAD data [www.festo.com](http://www.festo.com)

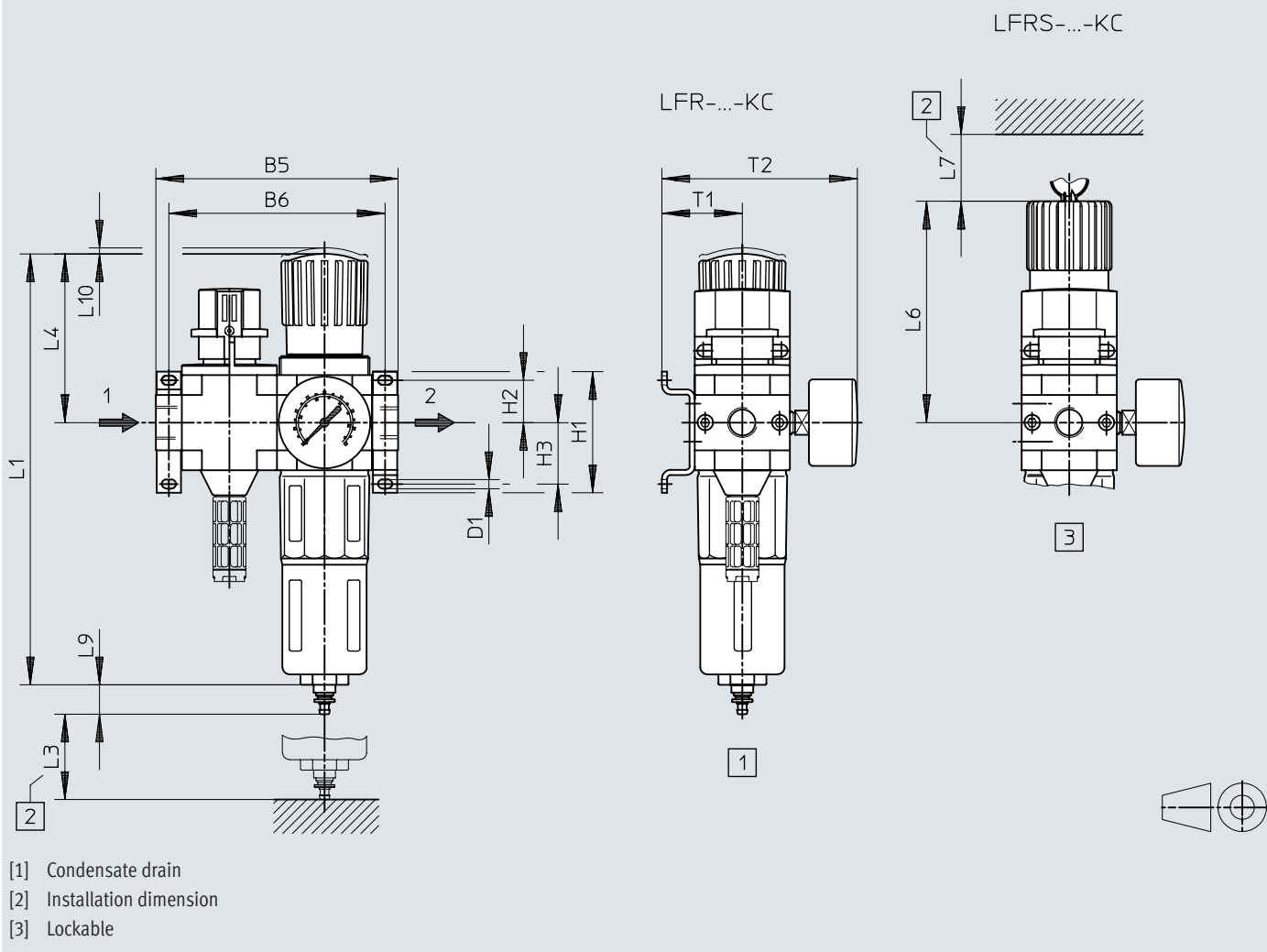

- [1] Condensate drain
- [2] Installation dimension
- [3] Lockable

	B5	B6	D1	H1	H2	H3	L1	L3	L4	L6	L7	L9	L10	T1	T2
LFR-...-D-MINI-KC (A)	104	92	4,3	43	17,5	17,5	193	60	68	98	60	19	3	39	95
LFR-...-D-MIDI-KC (A)	140	125	5,3	70	24,5	35,5	250	80	99	130	60	19	3	47	114
LFR-...-D-MAXI-KC (A)	162	146	5,3	70	24,5	35,5	252	90	82	111	60	19	3	53	126
LFR-...-D-DI-MAXI-KC (A)							275		105	135					

1) Note: This product complies with ISO 1179-1 and ISO 228-1.

# Dimensions

Dimensions – LFR...-KD

Download CAD data [www.festo.com](http://www.festo.com)

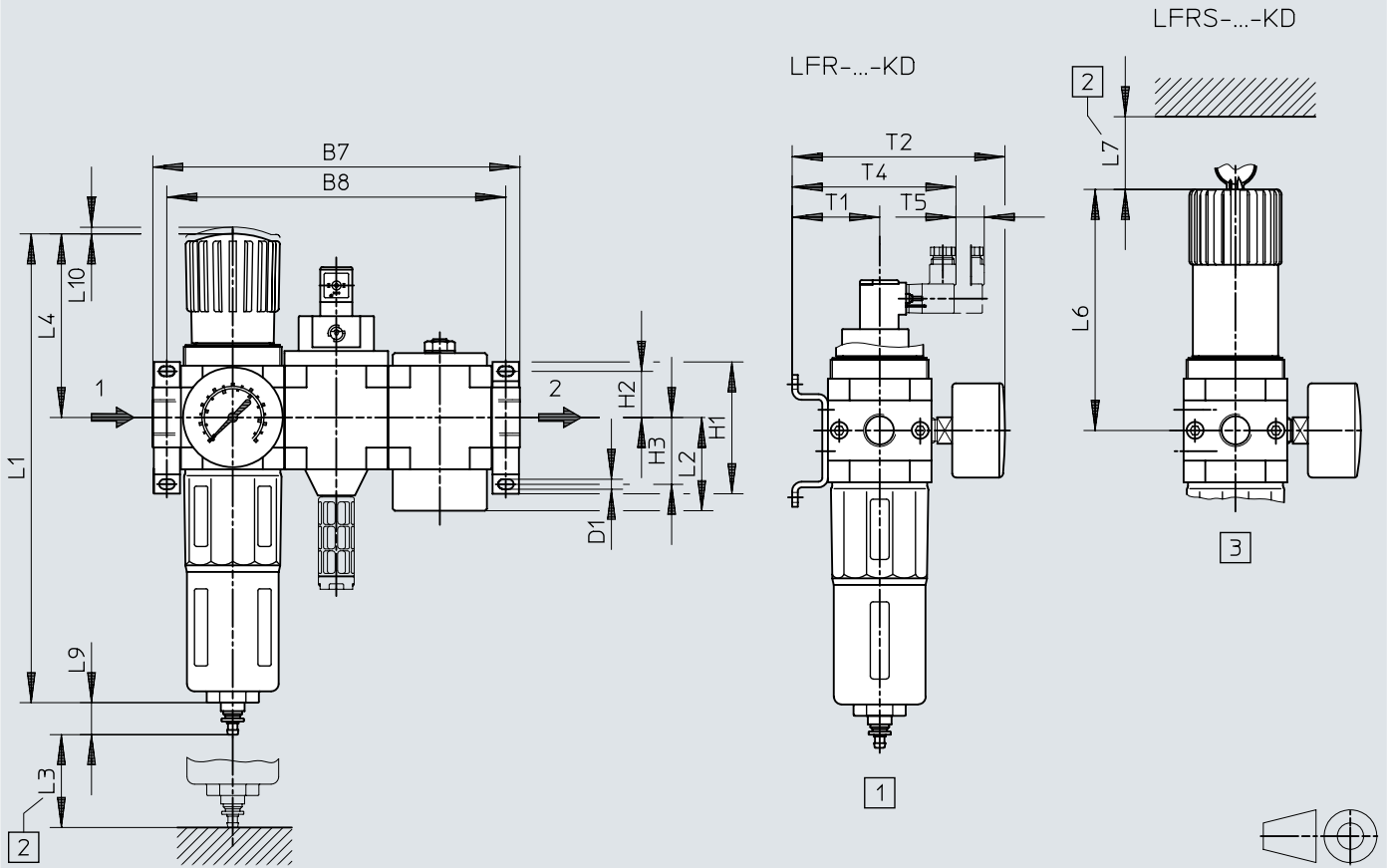

- [1] Condensate drain
- [2] Installation dimension
- [3] Lockable

	B7	B8	D1	H1	H2	H3	L1	L2	L3	L4	L6	L7	L9	L10	T1	T2	T4	T5
LFR...-D-MINI-KD (A)	144	132	4,3	43	17,5	17,5	193	36	60	68	98	60	19	3	39	95	78	15
LFR...-D-MIDI-KD (A)	195	180	5,3	70	24,5	35,5	250	49,5	80	99	130	60	19	3	47	114	86	15
LFR...-D-MAXI-KD (A)	228	212	5,3	70	24,5	35,5	252	56,4	90	82	111	60	19	3	53	126	92	15
LFR...-D-DI-MAXI-KD (A)							275			105	135							

1) Note: This product complies with ISO 1179-1 and ISO 228-1.

## Dimensions

Dimensions – LFR-...-KE

Download CAD data [www.festo.com](http://www.festo.com)

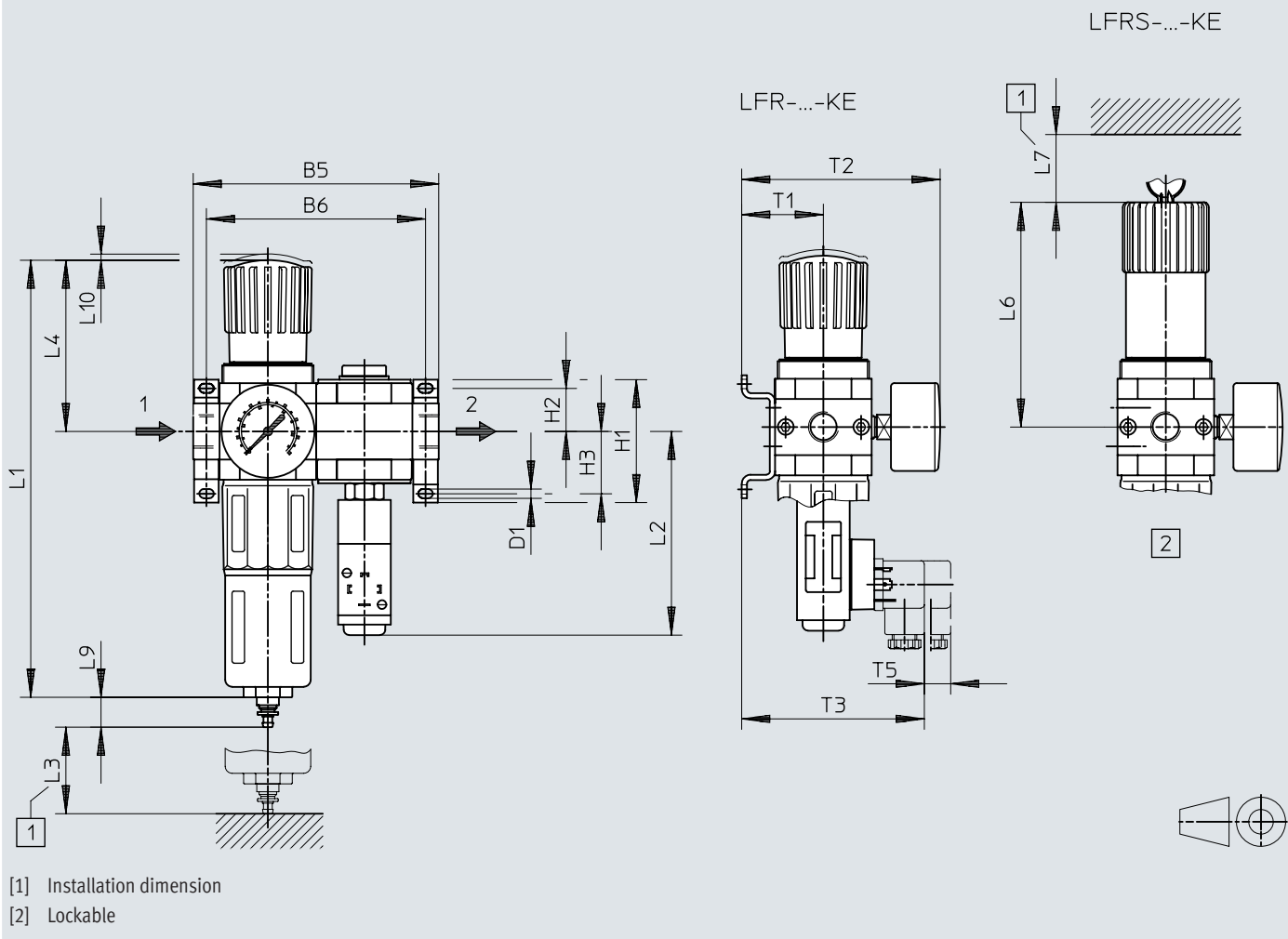

	B5	B6	D1	H1	H2	H3	L1	L2	L3	L4	L6	L7	L9	L10	T1	T2	T3	T5
LFR-...-D-MINI-KE (A)	104	92	4,3	43	17,5	17,5	193	108	60	68	98	60	19	3	39	95	97	15
LFR-...-D-MIDI-KE (A)	140	125	5,3	70	24,5	35,5	250	117	80	99	130	60	19	3	47	114	109	15
LFR-...-D-MAXI-KE (A)	162	146	5,3	70	24,5	35,5	252	122	90	82	111	60	19	3	53	126	111	15
LFR-...-D-DI-MAXI-KE (A)							275			105	135							

1) Note: This product complies with ISO 1179-1 and ISO 228-1.

## Dimensions

Dimensions – LFR...-KF

Download CAD data [www.festo.com](http://www.festo.com)

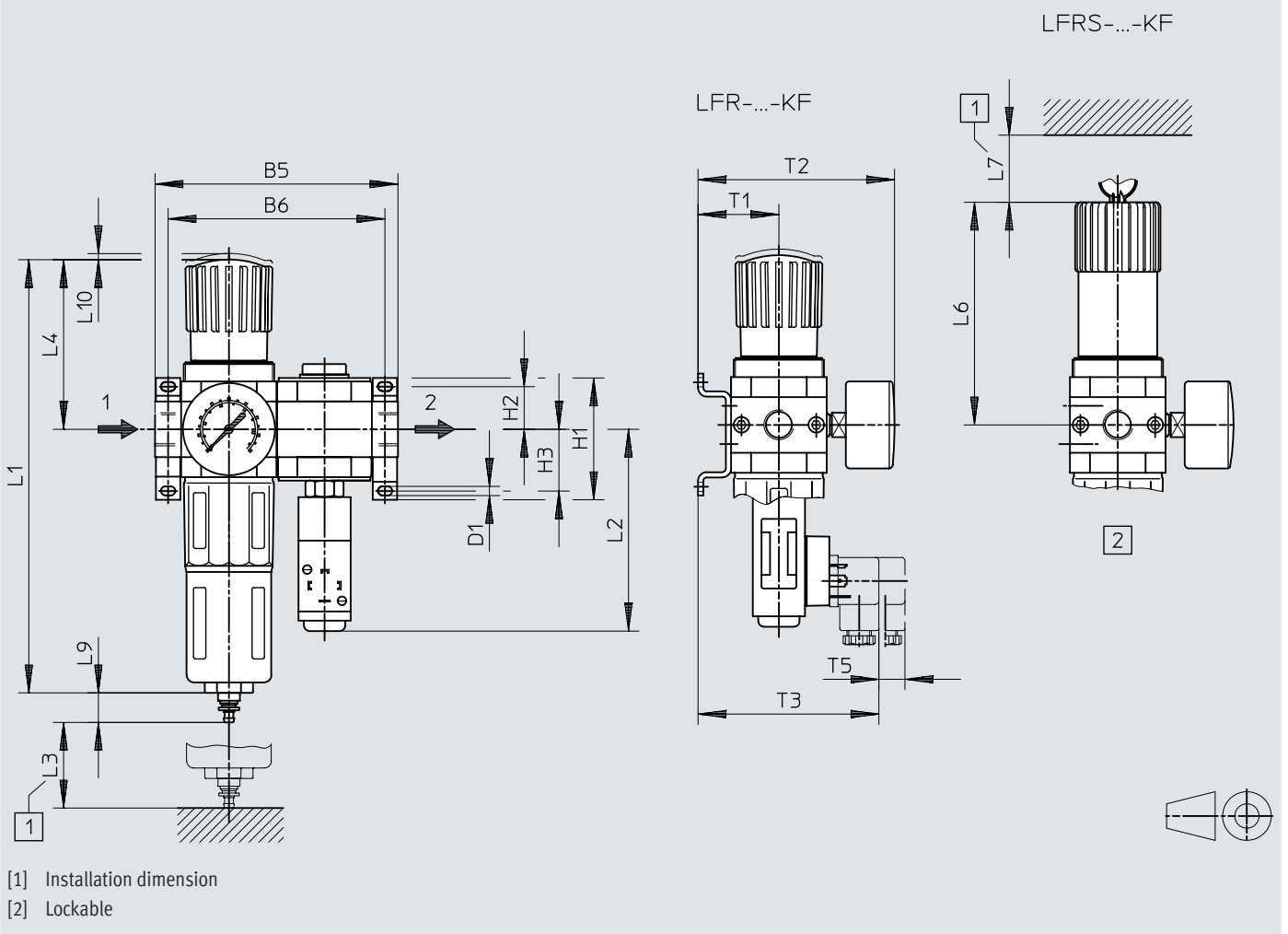

- [1] Installation dimension
- [2] Lockable

	B7	B8	D1	H1	H2	H3	L1	L2	L3	L4	L6	L7	L9	L10	T1	T2	T3	T5
LFR...-D-MINI-KF (A)	144	132	4,3	43	17,5	17,5	193	108	60	68	98	60	19	3	39	95	97	15
LFR...-D-MIDI-KF (A)	195	180	5,3	70	24,5	35,5	250	117	80	99	130	60	19	3	47	114	105	15
LFR...-D-MAXI-KF (A)	228	212	5,3	70	24,5	35,5	252	122	90	82	111	60	19	3	53	126	111	15
LFR...-D-DI-MAXI-KF (A)							275			105	135							

1) Note: This product complies with ISO 1179-1 and ISO 228-1.

## Dimensions

Dimensions – LFR-...-KG

Download CAD data [www.festo.com](http://www.festo.com)

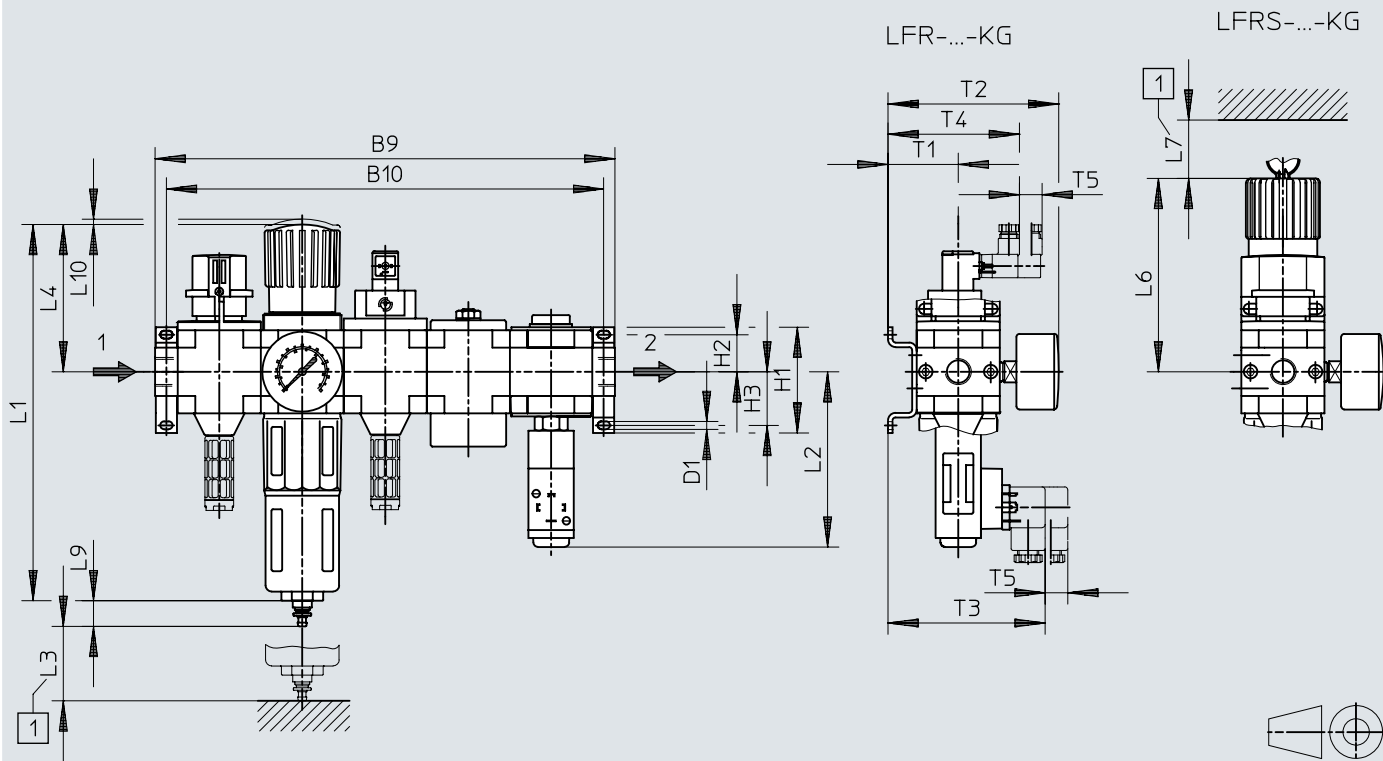

[1] Installation dimension

	B9	B10	D1	H1	H2	H3	L1	L2	L3	L4	L6	L7	L9	L10	T1	T2	T3	T4	T5
LFR-...-D-MINI-KG (A)	224	212	4,3	43	17,5	17,5	193	108	60	68	98	60	19	3	39	95	97	78	15
LFR-...-D-MIDI-KG (A)	305	290	5,3	70	24,5	35,5	250	117	80	99	130	60	19	3	47	114	105	86	15
LFR-...-D-MAXI-KG (A)	360	344	5,3	70	24,5	35,5	252	122	90	82	111	60	19	3	53	126	111	92	15
LFR-...-D-DI-MAXI-KG (A)							275			105	135								

1) Note: This product complies with ISO 1179-1 and ISO 228-1.

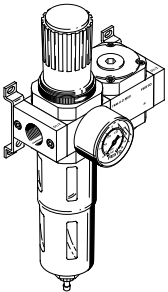

## Ordering data

LFR-...-D-...-KA						
	Size	Pneumatic connection, port 1	Pneumatic connection, port 2	Product weight	Part no.	Type
	Maxi	G1/2	G1/2	2,400 g	186040	LFR-1/2-D-MAXI-KA-A
					186039	LFR-1/2-D-MAXI-KA
		G3/4	G3/4		185717	LFR-3/4-D-MAXI-KA
					185718	LFR-3/4-D-MAXI-KA-A
	Midi	G1/4	G1/4	1,800 g	185711	LFR-1/4-D-MIDI-KA
					185712	LFR-1/4-D-MIDI-KA-A
		G3/8	G3/8		185713	LFR-3/8-D-MIDI-KA
					185714	LFR-3/8-D-MIDI-KA-A
		G1/2	G1/2		185716	LFR-1/2-D-MIDI-KA-A
	Mini	G1/8	G1/8	800 g	185715	LFR-1/2-D-MIDI-KA
					185708	LFR-1/8-D-MINI-KA-A
		G1/4	G1/4		185707	LFR-1/8-D-MINI-KA
			185709		LFR-1/4-D-MINI-KA	
			185710	LFR-1/4-D-MINI-KA-A		

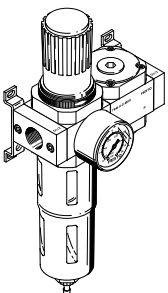
LFR-...-D-DI-...-KA (with directly actuated pressure regulator)						
	Size	Pneumatic connection, port 1	Pneumatic connection, port 2	Product weight	Part no.	Type
	Maxi	G1/2	G1/2	2,600 g	192454	LFR-1/2-D-DI-MAXI-KA-A
					192440	LFR-1/2-D-DI-MAXI-KA
		G3/4	G3/4		192461	LFR-3/4-D-DI-MAXI-KA-A

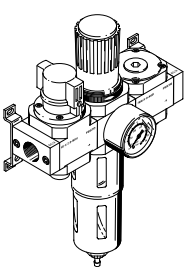
LFR-...-D-...-KB						
	Size	Pneumatic connection, port 1	Pneumatic connection, port 2	Product weight	Part no.	Type
	Maxi	G1/2	G1/2	3,300 g	186042	LFR-1/2-D-MAXI-KB-A
					186041	LFR-1/2-D-MAXI-KB
		G3/4	G3/4		185729	LFR-3/4-D-MAXI-KB
					185730	LFR-3/4-D-MAXI-KB-A
	Midi	G1/4	G1/4	2,200 g	185724	LFR-1/4-D-MIDI-KB-A
					185723	LFR-1/4-D-MIDI-KB
		G3/8	G3/8		185725	LFR-3/8-D-MIDI-KB
					185726	LFR-3/8-D-MIDI-KB-A
		G1/2	G1/2		185727	LFR-1/2-D-MIDI-KB
	Mini	G1/8	G1/8	1,000 g	185728	LFR-1/2-D-MIDI-KB-A
					185719	LFR-1/8-D-MINI-KB
		G1/4	G1/4		185720	LFR-1/8-D-MINI-KB-A
			185722		LFR-1/4-D-MINI-KB-A	
			185721	LFR-1/4-D-MINI-KB		

Ordering data

**LFR-...-D-DI-...-KB (with directly actuated pressure regulator)**

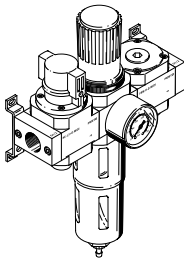
	Size	Pneumatic connection, port 1	Pneumatic connection, port 2	Product weight	Part no.	Type	
	Maxi	G1/2	G1/2	3,500 g	192455	LFR-1/2-D-DI-MAXI-KB-A	
		G3/4	G3/4		192441	LFR-1/2-D-DI-MAXI-KB	
						192448	LFR-3/4-D-DI-MAXI-KB
						192462	LFR-3/4-D-DI-MAXI-KB-A

**LFR-...-D-...-KC**

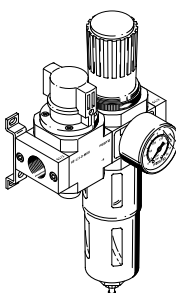
	Size	Pneumatic connection, port 1	Pneumatic connection, port 2	Product weight	Part no.	Type		
	Maxi	G1/2	G1/2	2,300 g	186044	LFR-1/2-D-MAXI-KC-A		
		G3/4	G3/4		186043	LFR-1/2-D-MAXI-KC		
						185741	LFR-3/4-D-MAXI-KC	
						185742	LFR-3/4-D-MAXI-KC-A	
	Midi	G1/4	G1/4	1,600 g	185736	LFR-1/4-D-MIDI-KC-A		
		G3/8	G3/8		185735	LFR-1/4-D-MIDI-KC		
							185737	LFR-3/8-D-MIDI-KC
							185738	LFR-3/8-D-MIDI-KC-A
	Mini	G1/8	G1/8	700 g	185740	LFR-1/2-D-MIDI-KC-A		
							185739	LFR-1/2-D-MIDI-KC
							185731	LFR-1/8-D-MINI-KC
							185732	LFR-1/8-D-MINI-KC-A
	G1/4	G1/4		185734	LFR-1/4-D-MINI-KC-A			
				185733	LFR-1/4-D-MINI-KC			

**LFR-...-D-DI-...-KC (with directly actuated pressure regulator)**

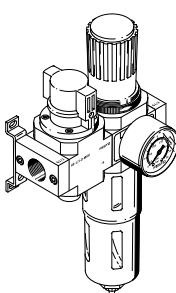
	Size	Pneumatic connection, port 1	Pneumatic connection, port 2	Product weight	Part no.	Type	
	Maxi	G1/2	G1/2	2,600 g	192442	LFR-1/2-D-DI-MAXI-KC	
		G3/4	G3/4		192456	LFR-1/2-D-DI-MAXI-KC-A	
						192463	LFR-3/4-D-DI-MAXI-KC-A
						192449	LFR-3/4-D-DI-MAXI-KC

**LFR-...-D-...-KD**

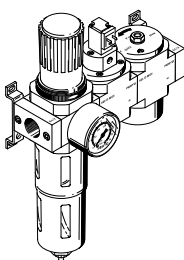
	Size	Pneumatic connection, port 1	Pneumatic connection, port 2	Product weight	Part no.	Type
	Maxi	G1/2	G1/2	3,100 g	186045	LFR-1/2-D-MAXI-KD

## Ordering data

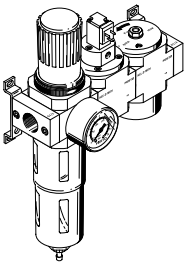
LFR-...-D-...-KD						
	Size	Pneumatic connection, port 1	Pneumatic connection, port 2	Product weight	Part no.	Type
	Maxi	G1/2	G1/2	3,100 g	186046	LFR-1/2-D-MAXI-KD-A
		G3/4	G3/4		185753	LFR-3/4-D-MAXI-KD
					185754	LFR-3/4-D-MAXI-KD-A
	Midi	G1/4	G1/4	2,100 g	185747	LFR-1/4-D-MIDI-KD
					185748	LFR-1/4-D-MIDI-KD-A
		G3/8	G3/8		185750	LFR-3/8-D-MIDI-KD-A
					185749	LFR-3/8-D-MIDI-KD
	G1/2	G1/2	185751	LFR-1/2-D-MIDI-KD		
			185752	LFR-1/2-D-MIDI-KD-A		
	Mini	G1/8	G1/8	900 g	185744	LFR-1/8-D-MINI-KD-A
		G1/4	G1/4		185743	LFR-1/8-D-MINI-KD
				185745	LFR-1/4-D-MINI-KD	
			185746	LFR-1/4-D-MINI-KD-A		

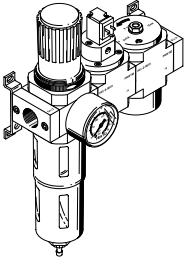
LFR-...-D-DI-...-KD (with directly actuated pressure regulator)						
	Size	Pneumatic connection, port 1	Pneumatic connection, port 2	Product weight	Part no.	Type
	Maxi	G1/2	G1/2	3,300 g	192443	LFR-1/2-D-DI-MAXI-KD
					192457	LFR-1/2-D-DI-MAXI-KD-A
		G3/4	G3/4		192450	LFR-3/4-D-DI-MAXI-KD

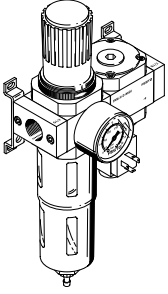
LFR-...-D-...-KE						
	Size	Pneumatic connection, port 1	Pneumatic connection, port 2	Product weight	Part no.	Type
	Maxi	G1/2	G1/2	2,400 g	186048	LFR-1/2-D-MAXI-KE-A
					186047	LFR-1/2-D-MAXI-KE
		G3/4	G3/4		185766	LFR-3/4-D-MAXI-KE-A
					185765	LFR-3/4-D-MAXI-KE
	Midi	G1/4	G1/4	2,000 g	185760	LFR-1/4-D-MIDI-KE-A
					185759	LFR-1/4-D-MIDI-KE
		G3/8	G3/8		185761	LFR-3/8-D-MIDI-KE
					185762	LFR-3/8-D-MIDI-KE-A
		G1/2	G1/2		185764	LFR-1/2-D-MIDI-KE-A
			185763	LFR-1/2-D-MIDI-KE		
	Mini	G1/8	G1/8	1,000 g	185756	LFR-1/8-D-MINI-KE-A
					185755	LFR-1/8-D-MINI-KE
G1/4		G1/4	185758		LFR-1/4-D-MINI-KE-A	
			185757	LFR-1/4-D-MINI-KE		

Ordering data

**LFR-...-D-DI-...-KE (with directly actuated pressure regulator)**

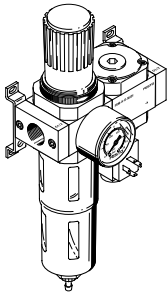
	Size	Pneumatic connection, port 1	Pneumatic connection, port 2	Product weight	Part no.	Type
	Maxi	G1/2	G1/2	2,600 g	192458	LFR-1/2-D-DI-MAXI-KE-A
					192444	LFR-1/2-D-DI-MAXI-KE
	G3/4	G3/4	192465	LFR-3/4-D-DI-MAXI-KE-A		

**LFR-...-D-...-KF**

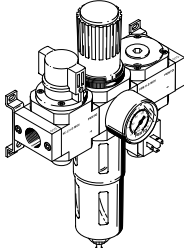
	Size	Pneumatic connection, port 1	Pneumatic connection, port 2	Product weight	Part no.	Type
	Maxi	G1/2	G1/2	3,300 g	186050	LFR-1/2-D-MAXI-KF-A
					186049	LFR-1/2-D-MAXI-KF
		G3/4	G3/4		185777	LFR-3/4-D-MAXI-KF
	Midi	G1/4	G1/4	2,400 g	185778	LFR-3/4-D-MAXI-KF-A
					185772	LFR-1/4-D-MIDI-KF-A
		G3/8	G3/8		185771	LFR-1/4-D-MIDI-KF
					185773	LFR-3/8-D-MIDI-KF
	Mini	G1/2	G1/2	1,200 g	185774	LFR-3/8-D-MIDI-KF-A
					185775	LFR-1/2-D-MIDI-KF
		G1/8	G1/8		185776	LFR-1/2-D-MIDI-KF-A
			185767		LFR-1/8-D-MINI-KF	
G1/4		G1/4	185768		LFR-1/8-D-MINI-KF-A	
		185769	LFR-1/4-D-MINI-KF			
			185770	LFR-1/4-D-MINI-KF-A		

**LFR-...-D-DI-...-KF (with directly actuated pressure regulator)**

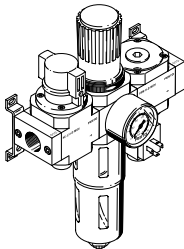
	Size	Pneumatic connection, port 1	Pneumatic connection, port 2	Product weight	Part no.	Type
	Maxi	G1/2	G1/2	3,500 g	192459	LFR-1/2-D-DI-MAXI-KF-A
					192445	LFR-1/2-D-DI-MAXI-KF
	G3/4	G3/4	192466	LFR-3/4-D-DI-MAXI-KF-A		
			192452	LFR-3/4-D-DI-MAXI-KF		

**LFR-...-D-...-KG**

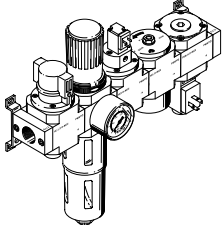
	Size	Pneumatic connection, port 1	Pneumatic connection, port 2	Product weight	Part no.	Type
	Maxi	G1/2	G1/2	5,200 g	186052	LFR-1/2-D-MAXI-KG-A

## Ordering data

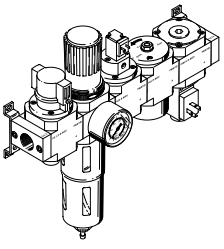
LFR-...-D-...-KG						
	Size	Pneumatic connection, port 1	Pneumatic connection, port 2	Product weight	Part no.	Type
	Maxi	G1/2	G1/2	5,200 g	186051	LFR-1/2-D-MAXI-KG
		G3/4	G3/4		185790	LFR-3/4-D-MAXI-KG-A
					185789	LFR-3/4-D-MAXI-KG
	Midi	G1/4	G1/4	3,400 g	185783	LFR-1/4-D-MIDI-KG
					185784	LFR-1/4-D-MIDI-KG-A
		G3/8	G3/8		185785	LFR-3/8-D-MIDI-KG
					185786	LFR-3/8-D-MIDI-KG-A
		G1/2	G1/2		185788	LFR-1/2-D-MIDI-KG-A
	Mini	G1/8	G1/8	1,500 g	185787	LFR-1/2-D-MIDI-KG
					185780	LFR-1/8-D-MINI-KG-A
		G1/4	G1/4		185779	LFR-1/8-D-MINI-KG
					185782	LFR-1/4-D-MINI-KG-A
		185781	LFR-1/4-D-MINI-KG			

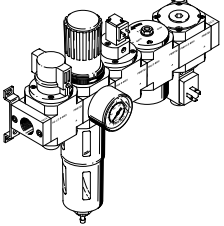
LFR-...-D-DI-...-KG (with directly actuated pressure regulator)						
	Size	Pneumatic connection, port 1	Pneumatic connection, port 2	Product weight	Part no.	Type
	Maxi	G1/2	G1/2	5,400 g	192446	LFR-1/2-D-DI-MAXI-KG
					192460	LFR-1/2-D-DI-MAXI-KG-A
		G3/4	G3/4		192453	LFR-3/4-D-DI-MAXI-KG
					192467	LFR-3/4-D-DI-MAXI-KG-A

## Peripherals

### Service unit LFR-K

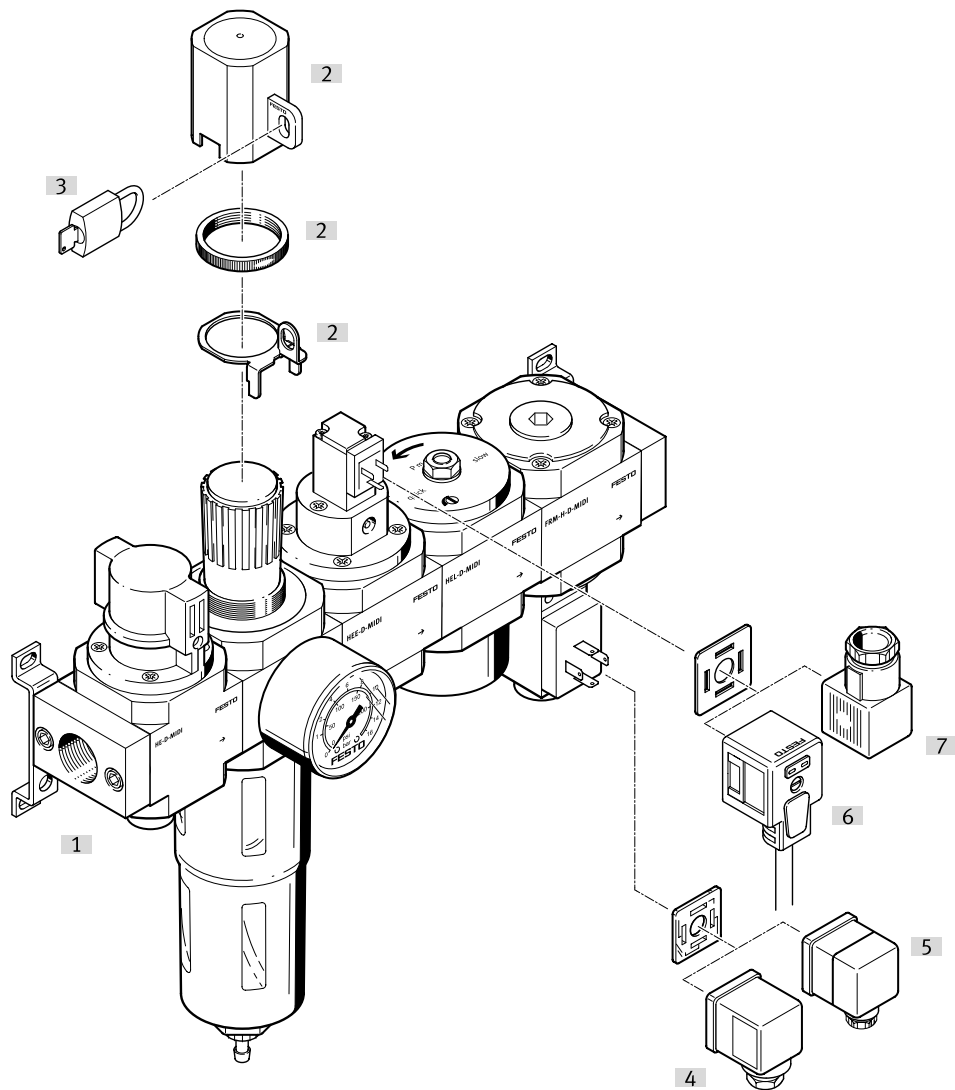

Accessories		→ Link
Type/order code	Description	
[1] Service unit LFR-K		<a href="#">lfr-k</a>
[2] Regulator lock LRVS		<a href="#">31</a>
[3] Padlock LRVS-D		<a href="#">32</a>
[4] Plug socket MSSD-C		<a href="#">31</a>
[5] Angled plug socket PEV-...-WD-LED		<a href="#">31</a>
[6] Plug socket with cable KMEB-1		<a href="#">31</a>
[7] Plug socket MSSD-EB		<a href="#">31</a>
[8] Filter cartridge LFP	Without illustration	<a href="#">32</a>

## Accessories

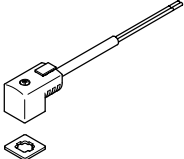
Plug socket with cable KMEB 230V AC				
	Nominal operating voltage AC	Cable length	Part no.	Type
	230 V	2.5 m	151690	KMEB-1-230AC-2.5
		5 m	151691	KMEB-1-230AC-5

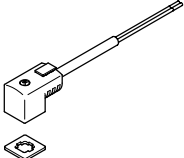
Plug socket with cable KMEB 24V DC				
	Nominal operating voltage DC	Cable length	Part no.	Type
	24 V	2.5 m	★ 151688	KMEB-1-24-2.5-LED
		5 m	151689	KMEB-1-24-5-LED
		10 m	193457	KMEB-1-24-10-LED

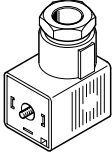
	Electrical connection	Cable fitting	Part no.	Type
	3-pin, Angled socket, Type A, To DIN EN 175301-803, Square design MSC, Square design MSN1	Pg 9	171157	MSSD-C-4P

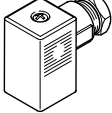
Plug socket MSSD-EB				
	Electrical connection	Part no.	Type	
	3-pin, Socket, Angled socket, Type C, To DIN EN 175301-803, To DIN EN 61984, Square design MSEB, Square design MSN2	★ 151687	MSSD-EB	
	4-pin, Socket, Type C	192745	MSSD-EB-S-M14	

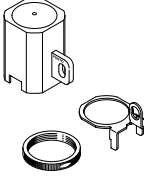
Regulator lock LRVS					
	Size	LABS (PWIS) conformity	Product weight	Part no.	Type
	Grid dimension 40 mm (without sub-bases)	VDMA24364-B1/B2-L	40 g	193781	LRVS-D-MINI
	Grid dimension 55 mm (without sub-bases)		60 g	193782	LRVS-D-MIDI
	Grid dimension 66 mm (without sub-bases)		36 g	193784	LRVS-D-DI-MAXI
			56 g	193783	LRVS-D-MAXI

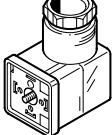
Angled plug socket PEV					
	Operational voltage range AC	Operational voltage range DC	Switching status indication	Part no.	Type
		15 ... 30 V	Yellow LED, Green LED	164274	PEV-1/4-WD-LED-24

## Accessories

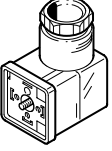
Angled plug socket PEV					
	Operational voltage range AC	Operational voltage range DC	Switching status indication	Part no.	Type
	150 ... 230 V	140 ... 180 V	Yellow LED, Green LED	<b>164275</b>	<b>PEV-1/4-WD-LED-230</b>

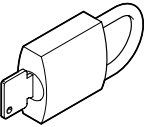
Padlock LRVS-D					
	Corrosion resistance class CRC <sup>1)</sup>	LABS (PWIS) conformity	Product weight	Part no.	Type
	2 - Moderate corrosion stress	VDMA24364-B1/B2-L	120 g	<b>193786</b>	<b>LRVS-D</b>

1) More information: [www.festo.com/x/topic/crc](http://www.festo.com/x/topic/crc)

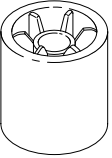
Filter cartridge LFP					
	Size	Grade of filtration	Part no.	Type	
	4	40 µm	★ <b>534502</b>	<b>MS4-LFP-E</b>	