

Filter regulator LFR-DB

FESTO



Characteristics

At a glance

- Space-saving design with filter and regulator in a single device.
- Good particle separation and high flow rate
- Good regulation characteristics with minimal hysteresis
- Optionally with manual or semi-automatic condensate drain.
- Setting values are secured by locking the rotary knob
- Choice of filter inserts 5 μm or 40 μm

Pressure gauge

[] With pressure gauge [0] Without pressure gauge



Type code

001	Series	
LFR	Filter regulator	
002	Pneumatic connection	
1/4	Female thread G1/4	
003	Version	
DB	D series, polymer	
004	Pressure regulation range	
7	0.5 ... 7 bar (0.05 ... 0.7 MPa)	

005	Grade of filtration	
	40 µm	
5M	5 µm	
006	Pressure gauge	
	With pressure gauge	
0	Without pressure gauge	
007	Size	
MINI	Grid dimension 40 mm (without connecting plates)	
008	Condensate drain	
H	Semi-automatic	
	Manually rotating	

Datasheet

General technical data

Design	Filter regulator with pressure gauge	Filter regulator without pressure gauge
Size	Mini	
Pneumatic connection, port 1	G1/4	
Pneumatic connection, port 2	G1/4	
Pressure gauge connection	G1/8	
Max. pressure hysteresis	0.5 bar	
Pressure regulation range	0.5 ... 7 bar	
Pressure gauge (ANALOG) or Pressure display (DIGITAL)	With pressure gauge	Prepared for G1/8
Condensate drain	Manually rotating Semi-automatic	
Controller function	With secondary venting, With return flow function	
Type of mounting	Either: In-line installation With through-hole Via mounting bracket	
Mounting position	Vertical +/-5°	
Grade of filtration	5 µm, 40 µm	
Actuator lock	Rotary knob with detent	
Air purity class at output	Compressed air to ISO 8573-1:2010 [6:8:4] Compressed air to ISO 8573-1:2010 [7:8:4] Inert gases	

Function LFR (manual condensate drain, with pressure gauge)

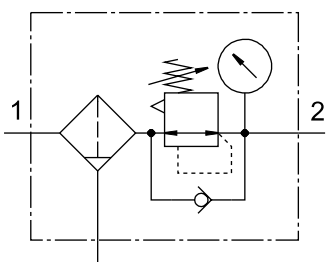

Function LFR (manual condensate drain, without pressure gauge)

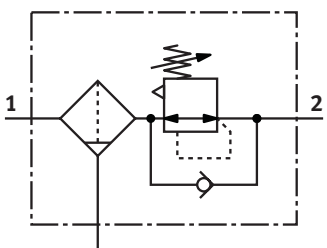

Function LFR (condensate drain semi-automatic, with pressure gauge)

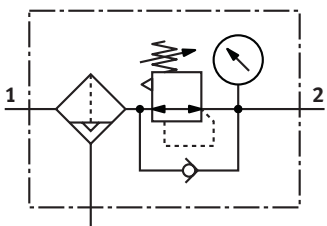

Datasheet

Function LFR (semi-automatic condensate drain, without pressure gauge)

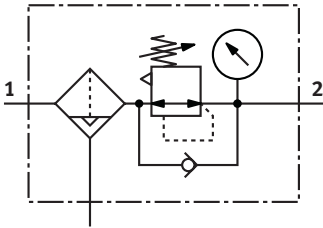

Standard nominal flow rate q_{nN}

Grade of filtration	5 μm	40 μm
Standard nominal flow rate (standardised to DIN 1343)	≥ 1000 l/min	≥ 1200 l/min

Operating and environmental conditions

Grade of filtration	5	40		
Condensate drain	Manually rotating	Semi-automatic	Manually rotating	Semi-automatic
Air purity class at output	Compressed air to ISO 8573-1:2010 [6:8:4], Inert gases		Compressed air to ISO 8573-1:2010 [7:8:4], Inert gases	
Operating pressure	1.5 ... 10 bar			
Operating medium	Compressed air to ISO 8573-1:2010 [-:9:-] Inert gases			
Ambient temperature	-5 ... 50°C			
Media temperature	-5 ... 50°C			
Corrosion resistance class CRC ¹⁾	1 - Low corrosion stress			

1) Corrosion resistance class CRC 3 to Festo standard FN 940070

High corrosion stress. Outdoor exposure under moderate corrosive conditions. External visible parts in direct contact with a normal industrial environment, with primarily functional surface requirements.

Materials

Material housing	PA-reinforced
Material bowl	PC
Material rotary knob	POM
Material seals	NBR
Material filter	PE
Note on materials	RoHS-compliant
LABS (PWIS) conformity	VDMA24364-B1/B2-L

Normal flow rate q_n as a function of the output pressure p_2 (grade of filtration 5 μm)

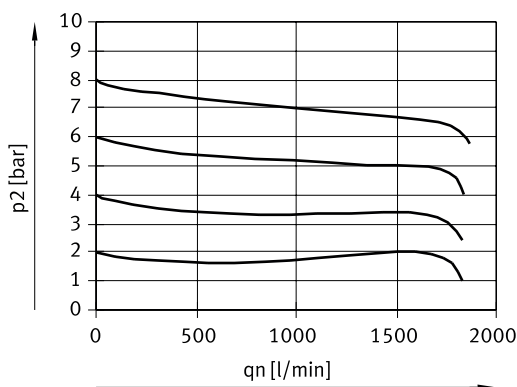

Input pressure $p_1 = 10$ bar

Datasheet

Normal flow rate q_n as a function of the output pressure p_2 (grade of filtration 40 μm)

Input pressure $p_1 = 10 \text{ bar}$

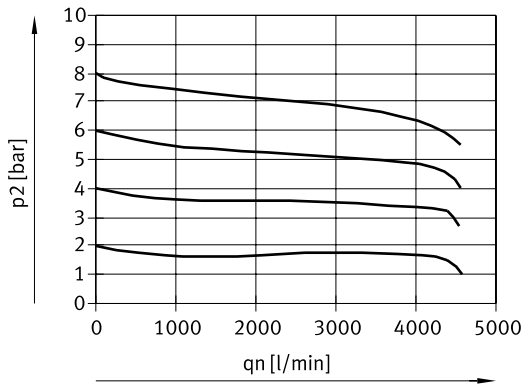

Dimensions

Dimensions – Filter control valve LFR-DB

Download CAD data www.festo.com

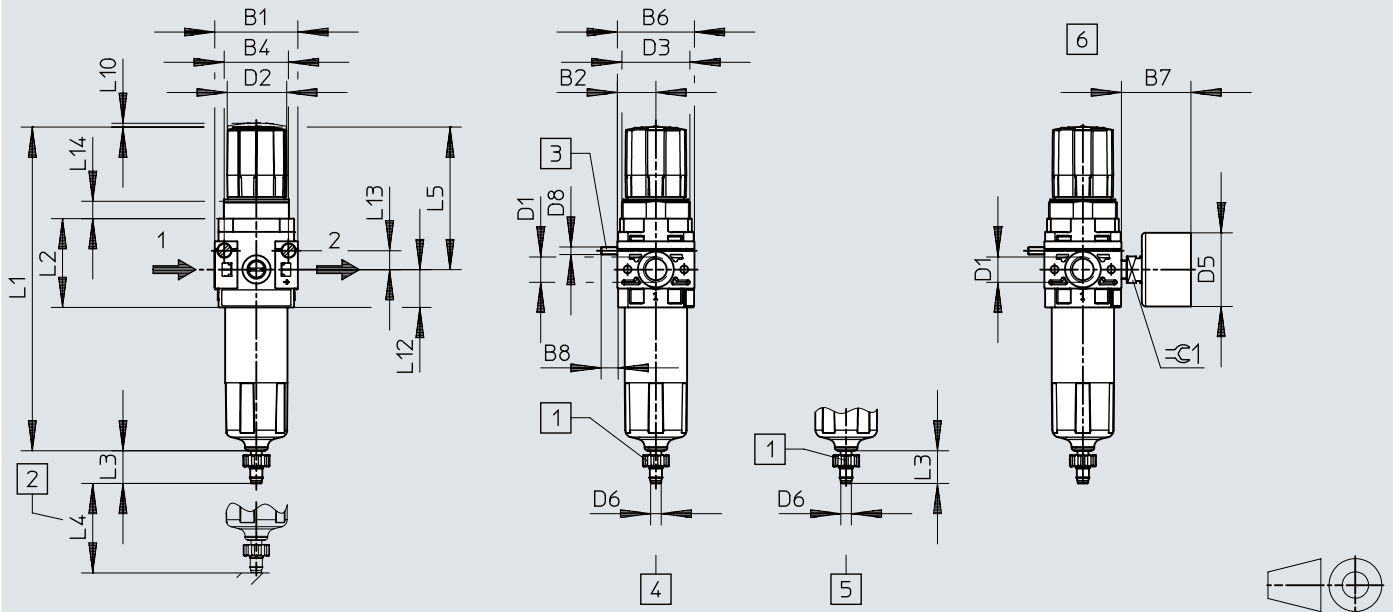

- [1] Barbed connector for plastic tubing PUN(-H)-8x1.25
- [2] Installation dimension
- [3] Socket head screw for wall mounting (2 included in the scope of delivery)
- [4] Manual condensate drain
- [5] Semi-automatic condensate drain
- [6] With pressure gauge

	B1	B2	B4	B6	B7 max.	B8	D1	D2 ∅	D3	D5 ∅	D6 ∅	D8
LFR-1/4-DB	44	20,5	34	41	37	9	G1/4	32	M36x1.5	39	5,6	M4

	L1	L2	L3	L4 min.	L5	L10	L12	L13	L14	⊕ 1
LFR-1/4-DB	171,7	47	17,3	60	76	2	20	10	9	14

Ordering data

Ordering data – without pressure gauge

	Size	Condensate drain	Pneumatic connection, port 1	Grade of filtration	Product weight	Part no.	Type
	Mini	Manually rotating	G1/4	5 µm	200 g	537644	LFR-1/4-DB-7-5M-O-MINI
				40 µm		537647	LFR-1/4-DB-7-O-MINI
		Semi-automatic		5 µm		537646	LFR-1/4-DB-7-5M-O-MINI-H
				40 µm		537645	LFR-1/4-DB-7-O-MINI-H

Ordering data – with pressure gauge

	Size	Condensate drain	Pneumatic connection, port 1	Grade of filtration	Product weight	Part no.	Type
	Mini	Manually rotating	G1/4	5 µm	200 g	539689	LFR-1/4-DB-7-5M-MINI
				40 µm		539685	LFR-1/4-DB-7-MINI
		Semi-automatic		5 µm		539690	LFR-1/4-DB-7-5M-MINI-H
				40 µm		539686	LFR-1/4-DB-7-MINI-H

Peripherals

Filter regulator LFR

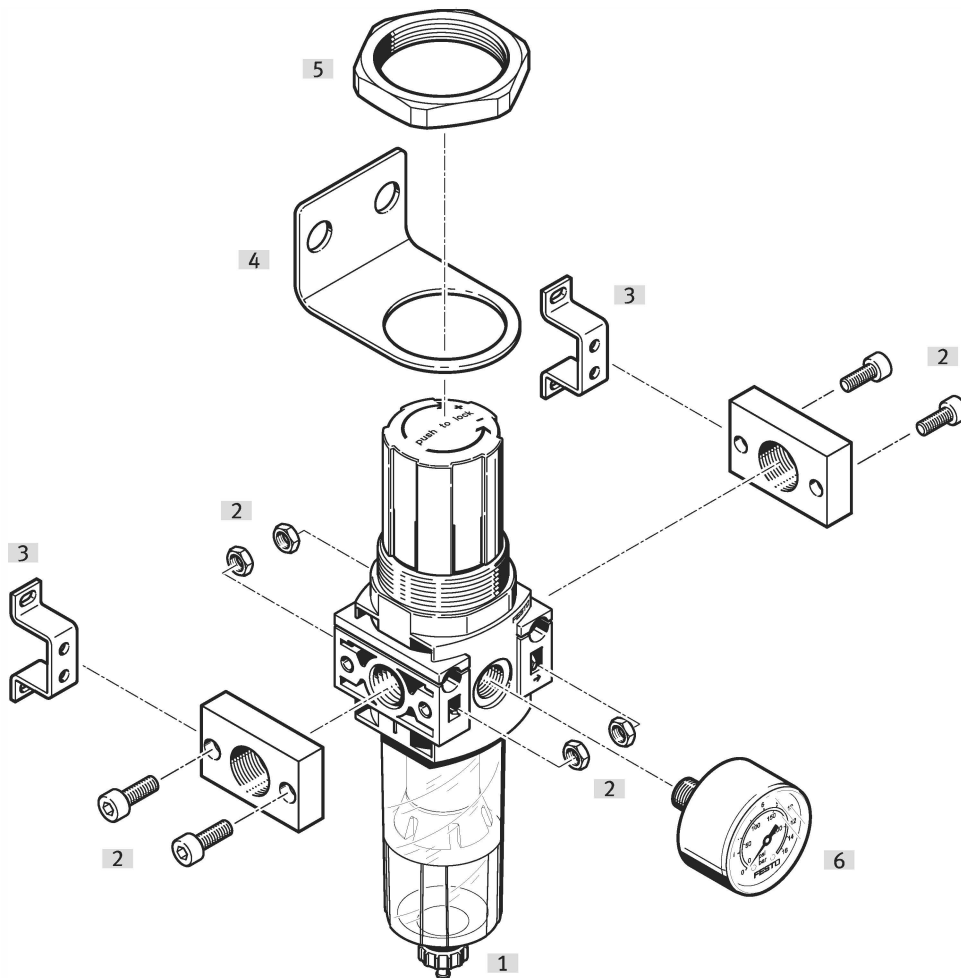

Accessories		→ Link
Type/order code	Description	
[1]	Filter regulator LFR	lfr-d
[2]	Connection kit PBL	10
[3]	Mounting bracket HFOE	10
[4]	Mounting bracket HR-D	10
[5]	Knurled nut HMR	Included in the scope of delivery lfr-d
[6]	Pressure gauge MA	11

Accessories

Mounting bracket HR-D-R3

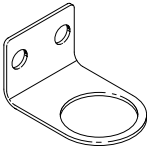
	Material bracket	Corrosion resistance class CRC ¹⁾	Product weight	Part no.	Type
	Steel	3 - high corrosion stress	73 g	4650310	HR-D-R3

1) Corrosion resistance class CRC 3 to Festo standard FN 940070

High corrosion stress. Outdoor exposure under moderate corrosive conditions. External visible parts with primarily functional surface requirements that are in direct contact with a normal industrial environment.

Mounting bracket HFOE-D-MIDI/MAXI

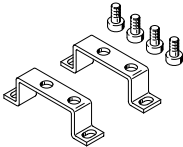
	Short type code	Corrosion resistance class CRC ¹⁾	Part no.	Type
	HFOE	2 - Moderate corrosion stress	159593	HFOE-D-MIDI/MAXI

1) More information: www.festo.com/x/topic/crc

Connection kit PBL

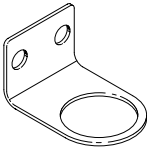
	Short type code	Material sub-base	Corrosion resistance class CRC ¹⁾	Part no.	Type
	PBL	Die-cast zinc	1 - Low corrosion stress	542789	PBL-3/8-DB-MINI
				542788	PBL-1/4-DB-MINI
				542787	PBL-1/8-DB-MINI

1) More information: www.festo.com/x/topic/crc

Filter cartridges, D series, polymer

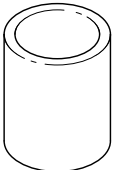
	Size	Grade of filtration ¹⁾	Part no.	Type
	4	40 µm	★ 534502	MS4-LFP-E

1) Grade of filtration 5 µm: colour blue

Grade of filtration 40 µm: colour white

Pressure gauge MA

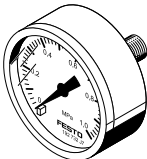
	Pneumatic connection	Indicating range	Conforms to standard	Product weight	Part no.	Type
	G1/8	0 ... 10 bar	EN 837-1	60 g	359874	MA-40-10-1/8

Accessories

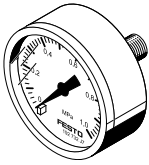
Pressure gauge MA						
	Pneumatic connection	Indicating range	Conforms to standard	Product weight	Part no.	Type
	G1/8	0 ... 16 bar	EN 837-1	60 g	345395	MA-40-16-1/8
	G1/4	0 ... 10 bar		70 g	183900	MA-40-10-G1/4-EN
		0 ... 16 bar			359873	MA-50-10-1/4
					356759	MA-50-16-1/4
	R1/8	0 ... 10 bar		60 g	162835	MA-40-10-1/8-EN

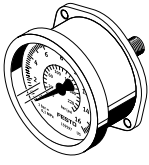
Flanged pressure gauge FMA						
	Size	Pneumatic connection	Indicating range	Product weight	Part no.	Type
	Diameter 40 mm	G1/4	0 ... 10 bar	80 g	159596	FMA-40-10-1/4-EN
			0 ... 16 bar		159597	FMA-40-16-1/4-EN
	Diameter 50 mm		0 ... 10 bar	100 g	159599	FMA-50-10-1/4-EN
			0 ... 16 bar		159600	FMA-50-16-1/4-EN