

Vacuum security valves ISV

FESTO



Key features

Range of applications

- For arranging multiple suction cups in parallel
 - so that the vacuum does not collapse if one or more suction cups are not tightly sealed
- Gripping randomly placed products
- Saves air and energy
 - gripping only takes place with full contact
- Maintains vacuum

Function diagram

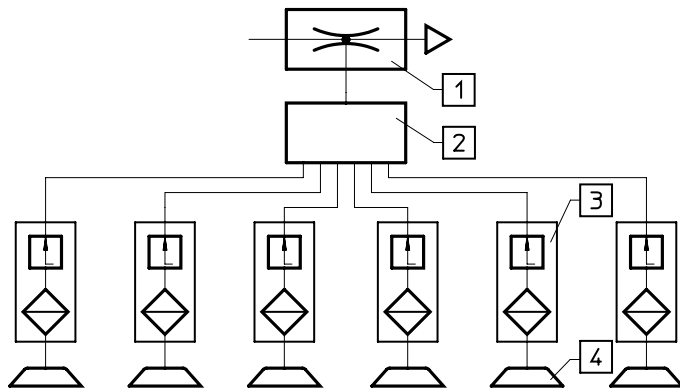

- [1] Vacuum generator
- [2] Distributor
- [3] Vacuum security valve
- [4] Suction cup

The vacuum security valves are designed to maintain the vacuum in applications where several suction cups are used and one or more suction cups fail.

Function of the security valve

The vacuum security valve ISV is mounted between the suction cup and the vacuum generator.

If, during vacuum generation, the suction cup is uncovered or only partly covered, the vacuum security valve automatically stops the influx of air.

Once the suction cup is seated tightly on the surface, the vacuum is switched back on again.

If the workpiece is separated from the suction cup, the vacuum security valve immediately closes.

1. If the suction cup is open to the environment, the float is pressed back against the housing. In this position, air can only flow through a small hole at the front of the float.
2. If a workpiece comes in contact with the suction cup, the air flow is reduced and the spring forces the float forward. This causes the vacuum security valve to open, and a complete vacuum is created in the suction cup.

Datasheet

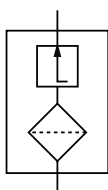

 Temperature range
 -10 ... +60°C

 Operating pressure
 -95 ... 0 kPa



General technical data							
Pneumatic connection 1, 2	For suction cup				For suction gripper		
	M5	G1/8	G1/4	G3/8	M4	M6	M10
Mounting position	Any						
Type of mounting	Screw-in						
Ejector pulse suitability [MPa]	≤ 0.8						
Required suction rate at -50 kPa [l/min]	1	2	1.6	1.5	1	2	2

Operating and environmental conditions							
Pneumatic connection 1, 2	For suction cup				For suction gripper		
	M5	G1/8	G1/4	G3/8	M4	M6	M10
Operating pressure [kPa]	-95 ... 0						
[bar]	-0.95 ... 0						
Operating medium	Atmospheric air based on ISO 8573-1:2010 [7:-:-]				L10		
Ambient temperature [°C]	-10 ... +60						
Corrosion resistance class CRC ¹⁾	2 - Moderate corrosion stress						

1) More information: www.festo.com/x/topic/crc

Materials							
Pneumatic connection 1, 2	For suction cup				For suction gripper		
	M5	G1/8	G1/4	G3/8	M4	M6	M10
Housing	High-alloy steel	Wrought aluminium alloy			Wrought aluminium alloy	Wrought aluminium alloy	
Filter	Sintered bronze	Wrought aluminium alloy, stainless steel mesh			Sintered bronze	Sintered bronze	
Spring	-	High-alloy steel			-	High-alloy steel	
Hollow bolt	-	Wrought aluminium alloy			-	-	
Float	-	POM			-	POM	
LABS (PWIS) conformity	VDMA24364-B1/B2-L	VDMA24364-B2-L			VDMA24364-B1/B2-L		

Datasheet

Evacuation time t as a function of the volume V to be evacuated with various vacuum generators

ISV-M5

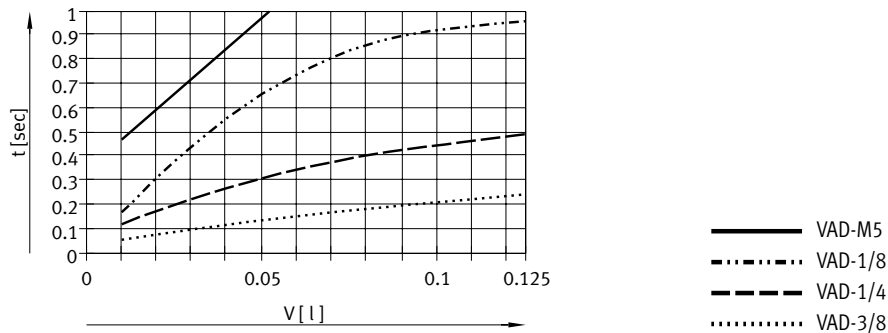

ISV-1/8; ISV-1/4

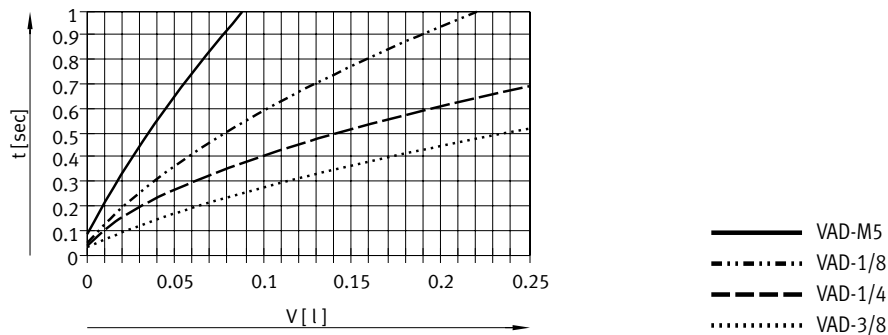

ISV-3/8

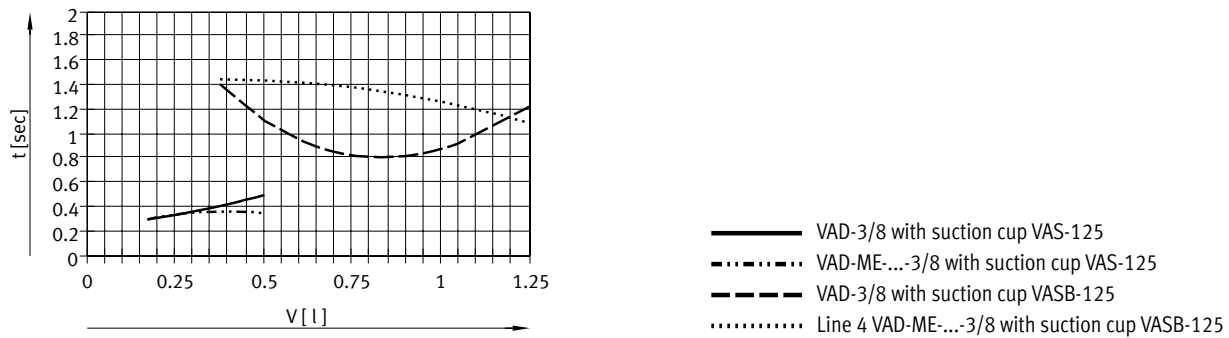

 Note

Evacuation time is the time required to achieve 90% of the maximum possible vacuum.

Datasheet

Conditions for operating the vacuum security valve ISV

- The number of suction cups that can be secured depends on the suction capacity of the vacuum generator.
- If the vacuum generator has a parallel connection, a minimum switching flow rate is required for the function of each vacuum security valve ISV.
- The number of suction cups that can be secured can be estimated from the ratio of the suction capacity of the vacuum generator to the minimum switching flow rate of the vacuum security valve ISV.

Max. number of secured suction cups as a function of the vacuum generator used and the vacuum that can be achieved

Vacuum generator	Max. number of suction cups at p_u [kPa]											
	ISV-M5			ISV-1/8			ISV-1/4			ISV-3/8		
	-50	-60	-70	-50	-60	-70	-50	-60	-70	-50	-60	-70
VAD-M5	2	1	–	1	1	–	1	–	–	–	–	–
VAD-1/8	4	2	1	2	1	–	2	1	–	–	–	–
VAD-1/4	8	6	3	4	3	1	4	3	1	–	–	–
VAD-3/8	8	8	7	7	6	3	7	6	3	–	2	1
VADM/VADMI-45	2	1	–	1	1	–	1	–	–	–	–	–
VADM/VADMI-70	4	2	1	2	1	–	2	1	–	–	–	–
VADM/VADMI-95	8	6	3	4	3	1	4	2	1	–	–	–
VADM/VADMI-140	8	8	7	7	6	3	7	6	3	3	2	1
VADM/VADMI-200	16	16	14	14	12	6	14	12	6	6	4	2
VADM/VADMI-300	32	32	28	28	24	12	28	14	12	12	8	4

Max. number of secured suction grippers as a function of the vacuum generator used and the vacuum that can be achieved

Vacuum generator	Max. number of suction grippers at p_u [kPa]								
	ISV-M4			ISV-M6			ISV-M10		
	-50	-60	-70	-50	-60	-70	-50	-60	-70
VAD-M5	2	1	–	1	1	–	1	1	–
VAD-1/8	4	2	1	2	1	–	2	1	–
VAD-1/4	8	6	3	4	3	1	4	3	1
VAD-3/8	8	8	7	7	6	3	7	6	3
VADM/VADMI-45	2	1	–	1	1	–	1	1	–
VADM/VADMI-70	4	2	1	2	1	–	2	1	–
VADM/VADMI-95	8	6	3	4	3	1	4	3	1
VADM/VADMI-140	8	8	7	7	6	3	7	6	3
VADM/VADMI-200	16	16	14	14	12	6	14	12	6
VADM/VADMI-300	32	32	28	28	24	12	28	24	12

Datasheet

Max. number of secured suction cups as a function of the vacuum generator used and the vacuum that can be achieved

Vacuum generator	Max. number of suction cups at p _u [kPa]			
	ISV-M5	ISV-1/8	ISV-1/4	ISV-3/8
	-50	-50	-50	-50
OVEL-5-H	2	1	1	1
OVEL-5-L	2	1	1	1
OVEL-7-H	6	3	3	4
OVEL-7-L	11	5	6	7
OVEL-10-H	8	4	5	5
OVEL-10-L	19	9	12	13
OVEM-...-B-14-H	15	7	9	10
OVEM-...-B-14-L	37	18	23	24
OVEM-...-B-20-H	30	15	18	20
OVEM-...-C-20-H	39	19	24	26
OVEM-...-C-20-L	84	42	52	56
OVEM-...-C-30-H	70	35	43	46
OVEM-...-C-30-L	115	57	72	76
VN-05-H	2	1	1	1
VN-05-L	3	1	1	2
VN-05-M	1	0	1	1
VN-07-H	5	2	3	3
VN-07-M	3	1	1	2
VN-10-H	10	5	6	6
VN-10-L	10	5	6	6
VN-10-M	8	4	5	5
VN-14-H	23	11	14	15
VN-14-L	3	1	2	2
VN-20-H	36	18	23	24
VN-30-H	68	34	43	45
VN-30-L	131	65	81	87
VN-05-H-...-A/B/M/P	2	1	1	1
VN-05-L-...-A/B/M/P	4	2	2	3
VN-07-H-...-A/B/M/P	6	3	3	4
VN-07-L-...-A/B/M/P	0	0	0	0
VN-10-H-...-A/B/M/P	8	4	5	5
VN-10-L-...-A/B/M/P	18	9	11	12
VN-14-H-...-A/B/M/P	15	7	9	10
VN-14-L-...-A/B/M/P	40	20	25	26
VN-20-H-...-A/B/M/P	36	18	23	24
VN-30-H-...-A/B/M/P	68	34	43	45

Datasheet

Max. number of secured suction grippers as a function of the vacuum generator used and the vacuum that can be achieved			
Vacuum generator	Max. number of suction grippers at $p_{\text{ü}}$ [kPa]		
	ISV-M4	ISV-M6	ISV-M10
	-50	-50	-50
OVEL-5-H	2	1	1
OVEL-5-L	2	1	1
OVEL-7-H	6	3	3
OVEL-7-L	11	5	5
OVEL-10-H	8	4	4
OVEL-10-L	19	9	9
OVEM-...-B-14-H	15	7	7
OVEM-...-B-14-L	37	18	18
OVEM-...-B-20-H	30	15	15
OVEM-...-C-20-H	39	19	19
OVEM-...-C-20-L	84	42	42
OVEM-...-C-30-H	70	35	35
OVEM-...-C-30-L	115	57	57
VN-05-H	2	1	1
VN-05-L	3	1	1
VN-05-M	1	0	0
VN-07-H	5	2	2
VN-07-M	3	1	1
VN-10-H	10	5	5
VN-10-L	10	5	5
VN-10-M	8	4	4
VN-14-H	23	11	11
VN-14-L	3	1	1
VN-20-H	36	18	18
VN-30-H	68	34	34
VN-30-L	131	65	65
VN-05-H-...-A/B/M/P	2	1	1
VN-05-L-...-A/B/M/P	4	2	2
VN-07-H-...-A/B/M/P	6	3	3
VN-07-L-...-A/B/M/P	0	0	0
VN-10-H-...-A/B/M/P	8	4	4
VN-10-L-...-A/B/M/P	18	9	9
VN-14-H-...-A/B/M/P	15	7	7
VN-14-L-...-A/B/M/P	40	20	20
VN-20-H-...-A/B/M/P	36	18	18
VN-30-H-...-A/B/M/P	68	34	34

Datasheet

Dimensions

For suction cup

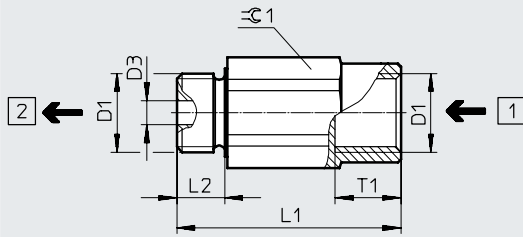

[1] Suction side

[2] Tube side

For suction gripper

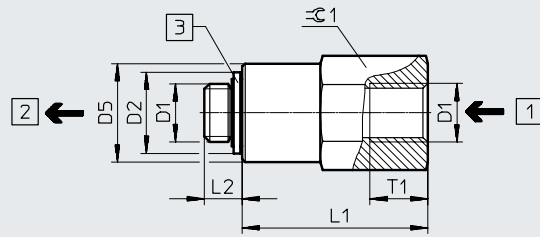

[1] Suction side

[2] Tube side

[3] Sealing ring

Type	D1	D2 ∅	D3 ∅	D5 ∅	L1	L2	T1	±0.1
For suction cup								
ISV-M5	M5	–	2	–	15	4.3	5.5	8
ISV-1/8	G1/8	–	4	–	36	6.5	11	13
ISV-1/4	G1/4	–	4	–	37.5	8	11	17
ISV-3/8	G3/8	–	4	–	42	9	13	22
For suction gripper								
ISV-M4	M4	7.8	–	7	10.7	3.8	5	7
ISV-M6	M6	8.4	–	14	28.3	5	5	14
ISV-M10	M10	13	–	17	32	6.5	10	17

Ordering data

Description	Pneumatic connection 1, 2	Product weight [g]	Part no.	Type
For suction cup	M5	4	151217	ISV-M5
	G1/8	9	33969	ISV-1/8
	G1/4	16	33970	ISV-1/4
	G3/8	33	33971	ISV-3/8
For suction gripper	M4	1.5	545996	ISV-M4
	M6	14	545997	ISV-M6
	M10	18	545998	ISV-M10