

Radial grippers HGRT, heavy-duty

FESTO



Key features

At a glance

- Sturdy and precise kinematics for maximum torque resistance and long service life
- The plain-bearing guide is virtually backlash-free thanks to the ground-in gripper jaws
- Systematic use of high-performance and lightweight materials
- The force generated by the linear motion is translated into the gripper jaw movement via a slotted guide on the piston rod.
This also guarantees synchronous movement of the gripper jaws
- The opening angle of the gripper jaws is freely adjustable up to max. 90° per gripper finger. This prevents the grippers jaws from opening too far and colliding
- Can be used as a double-acting or single-acting gripper
- Compression spring for supplementing or retaining the gripping forces
- Suitable for external and internal gripping
- Wide range of options for mounting on drives

Flexible stroke limitation



On delivery, the gripper has a fixed stop that enables an opening angle of 180°. With the stroke reducing kit HGRT-HR, which can be ordered as an accessory, the opening angle can be reduced by using an adjustment screw. This is an easy way of converting the radial gripper into an angle gripper.

Other ports

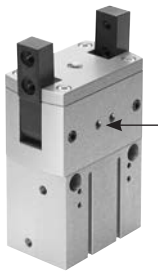

For sealing air

Compressed air flows past the gripper jaws when sealing air (max. 0.5 bar) is connected. This prevents, for example, dust particles from entering the gripper jaw guide.

For lubrication nipple

The ports can also be used to re-lubricate the guide.

Position sensing/force control

With position transmitter SMAT-8M



Analogue position feedback possible

- Analogue output
 - 0 ... 10 V
 - 4 ... 20 mA

With proportional pressure regulator VPPM



Infinite adjustment of the gripping force possible

- Setpoint value input
 - 0 ... 10 V
 - 4 ... 20 mA

With proximity sensor SMT-8G/-10G



Detecting multiple positions:

- Open
- Closed
- Workpiece gripped

Key features

Supply ports

Direct

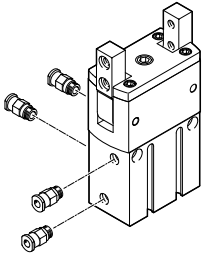

Via adapter plate

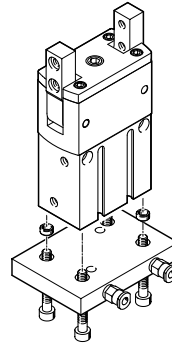

Note

Engineering software
for gripper selection
→ www.festo.com

Mounting options

Direct mounting

At the side

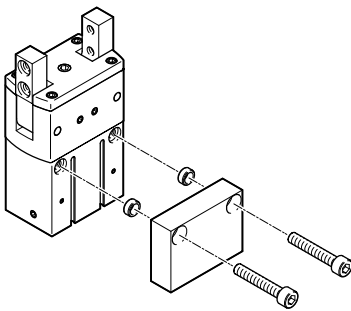

On the front

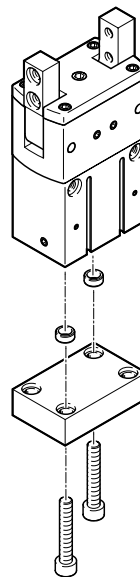

Note

Radial grippers are not designed for
the following sample applications:

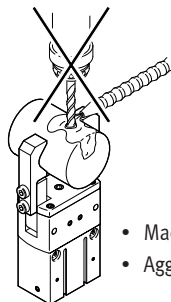

- Machining
- Aggressive media

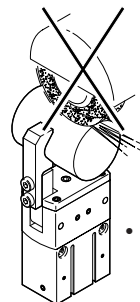

- Grinding dust

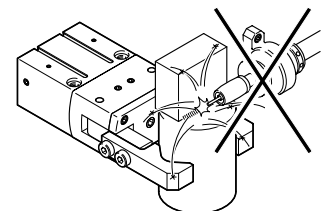

- Welding spatter

Type codes

001	Series
HGRT	Radial gripper

002	Size
16	16
20	20
25	25
32	32
40	40
50	50

003	Position sensing
A	For proximity sensor

004	Gripping force backup
	None
G2	N/O contact

Peripherals overview

Peripherals overview

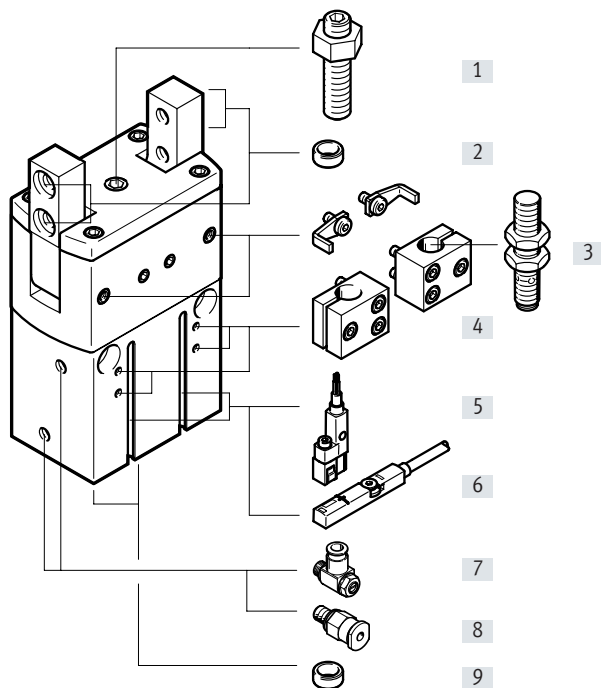

System product for handling and assembly technology

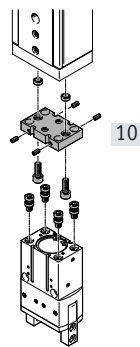

Proportional-pressure regulator VPPM

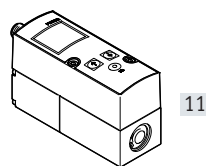

Accessories			
Type	Size	Description	→ Page/Internet
[1] Stroke reducing kit HGRT-HR	16 ... 50	For adjusting the opening angle	19
[2] Centring sleeve ZBH	16 ... 50	<ul style="list-style-type: none"> For centring when attaching gripper fingers 4 included in the scope of delivery of the gripper 	20
[3] Proximity sensor SIEN	16 ... 50	For sensing the piston position	21
[4] Sensor bracket DASI	16 ... 50	<ul style="list-style-type: none"> For mounting the proximity sensors SIEN on the gripper Switch lugs included in the scope of delivery of the sensor bracket 	19
[5] Proximity sensor SMT-8G/-10G	16 ... 50	<ul style="list-style-type: none"> For sensing the piston position Proximity sensor does not project past the housing at the bottom 	20
[6] Position transmitter SMAT-8M	40	<ul style="list-style-type: none"> Continuously senses the position of the piston. It has an analogue output with an output signal relative to the piston position. 	21
Position transmitter SDAT	40, 50		
[7] One-way flow control valve GRLA	16 ... 50	For speed regulation	grla
[8] Push-in fitting QS	16 ... 50	For connecting compressed air tubing with standard O.D.	qs
[9] Centring sleeve ZBH	16 ... 50	For centring when attaching to a drive or plate	20
[10] Adapter kit DHAA, HAPG	16 ... 50	Connecting plate between drive and gripper	17
[11] Proportional-pressure regulator VPPM	16 ... 50	For infinite adjustment of the gripping force	vppm

Radial grippers HGRT, heavy-duty

Data sheet

-  Size
12 ... 50 mm
-  Opening angle
180°

Double-acting

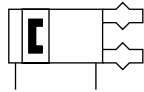

Single-acting or with gripping force retention

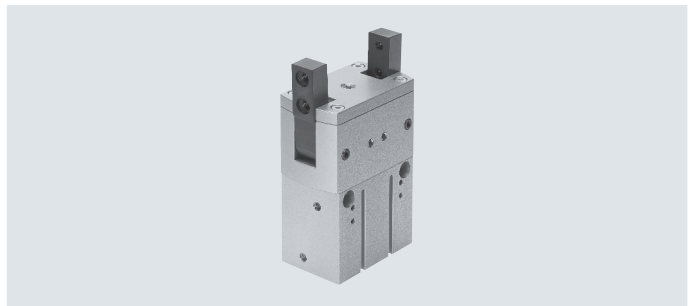
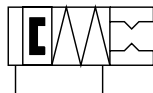

General technical data

Size	16	20	25	32	40	50
Design	Force-guided motion sequence					
Mode of operation	Double-acting					
Gripper function	Radial					
Number of gripper jaws	2					
Max. opening angle [°]	180					
Pneumatic connection	M3	M5	M5	M5	G1/8	G1/8
Repetition accuracy ¹⁾ [mm]	≤ 0.02					
Max. interchangeability [mm]	≤ 0.2					
Max. gripper jaw backlash ²⁾ [mm]	≤ 0.1					
Max. gripper jaw angular backlash ³⁾ [°]	≤ 0.1					
Max. permitted operating frequency [Hz]	≤ 3				≤ 2	
Rotational symmetry [mm]	≤ ∅ 0.2					
Position sensing	Via proximity sensor				Position transmitter	
Type of mounting	Via female thread and centring sleeve					
Mounting position	Any					
Product weight						
HGRT...-A [g]	130	290	540	840	1580	3100
HGRT...-A-G2 [g]	150	320	610	940	1770	3500

- 1) Under constant exposure to operating conditions, end-position drift occurs in the direction of movement of the gripper jaws, at 100 consecutive strokes
- 2) Perpendicular to the direction of motion of the gripper jaws
- 3) Preloaded, backlash-free ball guide

Operating and environmental conditions

Operating pressure		
HGRT...-A [bar]	3 ... 8	
HGRT...-A-G2 [bar]	4 ... 8	
Operating medium	Compressed air to ISO 8573-1:2010 [7:4:4]	
Note on the operating/pilot medium	Lubricated operation possible (in which case lubricated operation will always be required)	
Ambient temperature ¹⁾ [°C]	+5 ... +60	
Corrosion resistance class CRC ²⁾	1	

- 1) Note operating range of proximity sensors
- 2) Corrosion resistance class CRC 2 to Festo standard FN 940070
Moderate corrosion stress. Indoor applications in which condensation can occur. External visible parts with primarily decorative surface requirements which are in direct contact with a normal industrial environment.

Data sheet

Materials

Sectional view

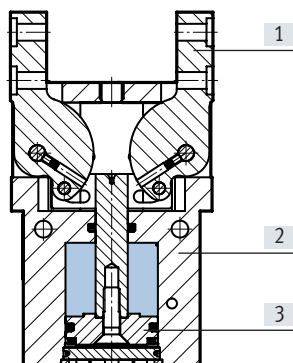

Radial gripper

[1] Gripper jaws	Hardened steel
[2] Housing	Smooth anodised aluminium
[3] Piston	Anodised aluminium
- Seals	Polyurethane, NBR
- Note on materials	Free of copper and PTFE
	RoHS-compliant

Total gripping torque at 6 bar

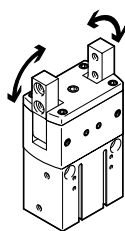

The gripping torque is not constant across the opening angle
→ page 12

Size		16	20	25	32	40	50
Opening	[Ncm]	188	588	1348	2024	3892	8424
Closing	[Ncm]	158	516	1208	1856	3526	7754

Static characteristic load values at the gripper jaws

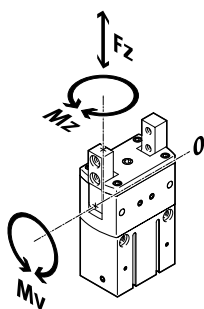

The indicated permissible forces and torques apply to a single gripper jaw. The indicated values include the lever arm, additional applied loads caused by the workpiece or external gripper fingers, as well as forces which occur during movement.

The zero coordinate line (gripper jaw guide) must be taken into consideration when calculating torques.

Size		16	20	25	32	40	50
Max. permissible force F_z	[N]	50	100	180	280	400	1200
Max. permissible torque M_y	[Nm]	3.9	6.2	10	13.5	17.5	35
Max. permissible torque M_z	[Nm]	0.3	0.5	1	1.3	1.6	10

Data sheet

Mass moment of inertia [kgm²x10⁻⁴]

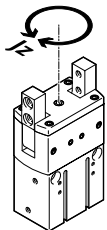

Mass moment of inertia of the radial gripper in relation to the central axis, without external gripper fingers, with no load.

Size	16	20	25	32	40	50
HGRT...-A	0.191	0.74	2.1	4.62	13.87	43.39
HGRT...-A-G2	0.21	0.81	2.33	5.03	15.26	47.70

Opening and closing times [ms] at 6 bar

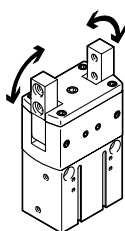

The indicated opening and closing times [ms] have been measured at room temperature and 6 bar operating pressure with a vertically mounted gripper and without additional gripper fingers.

The grippers must be throttled for greater applied loads. Opening and closing times must then be adjusted accordingly.

Size		16	20	25	32	40	50
Without external gripper fingers							
HGRT...-A	Opening	246	280	309	359	283	350
	Closing	293	308	343	403	320	403
HGRT...-A-G2	Opening	233	372	443	503	370	490
	Closing	185	295	301	337	270	355

Data sheet

Permissible mass moment of inertia J with external gripper fingers as a function of opening and closing times t at 6 bar

HGRT-16

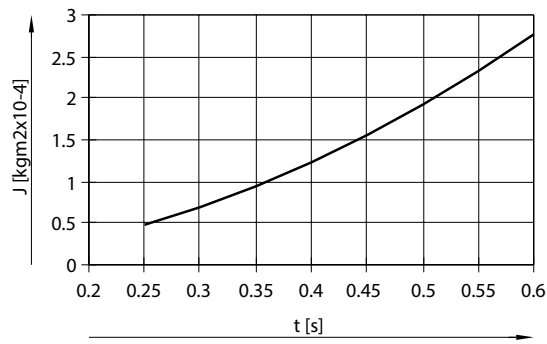

HGRT-20

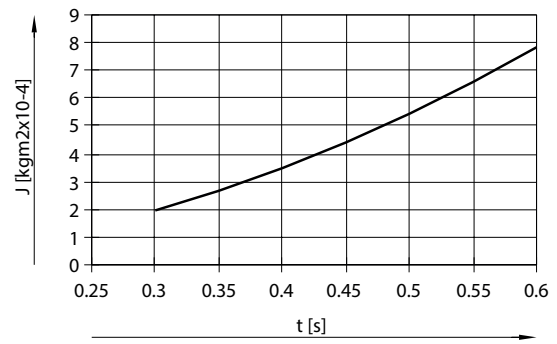

HGRT-25

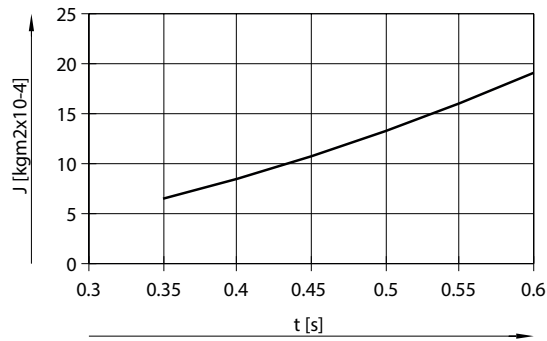

HGRT-32

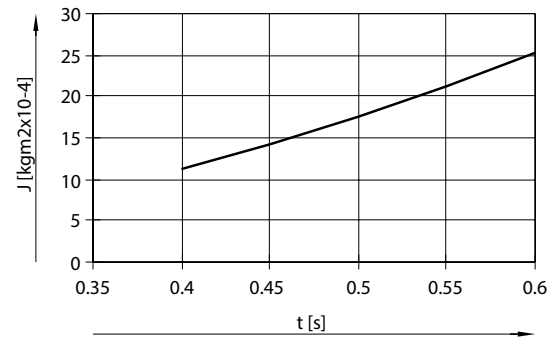

HGRT-40

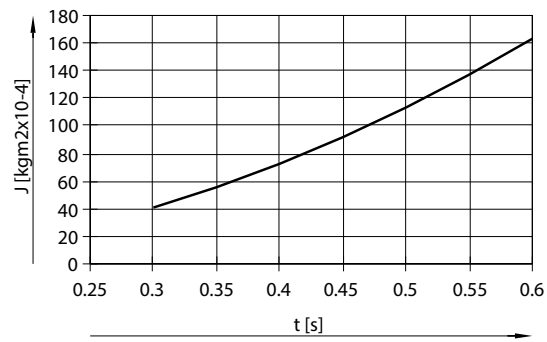

HGRT-50

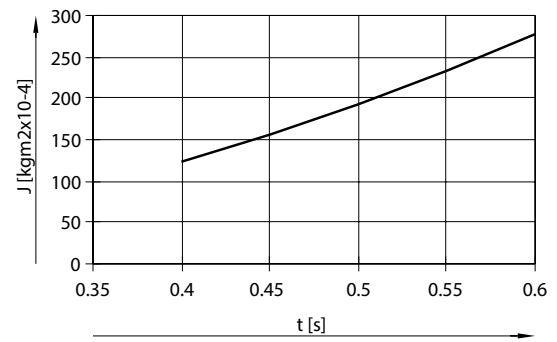

Data sheet

Gripping force F_H per gripper jaw as a function of operating pressure and lever arm x

Gripping forces as a function of the operating pressure and the lever arm can be determined for the size using the following graph.

The gripping torque is not constant across the opening angle → page 12

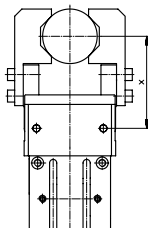

External gripping (closing)

HGRT-16

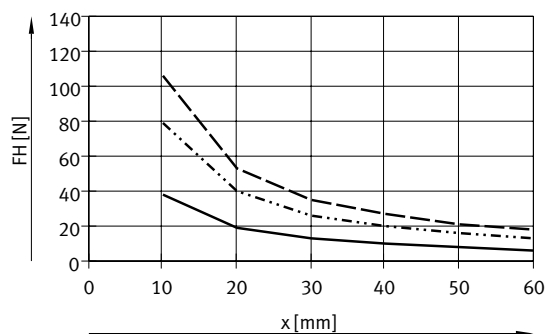

HGRT-20

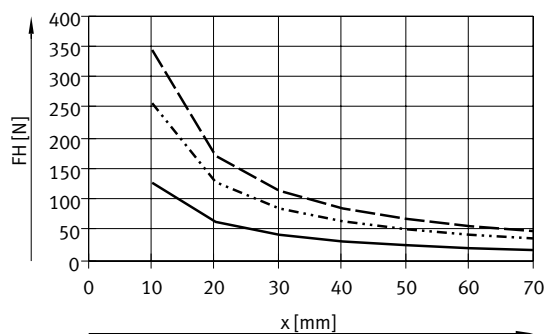

HGRT-25

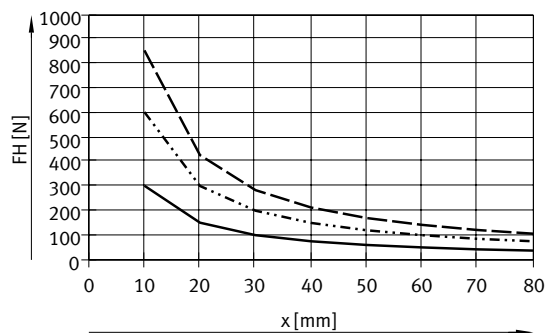

HGRT-32

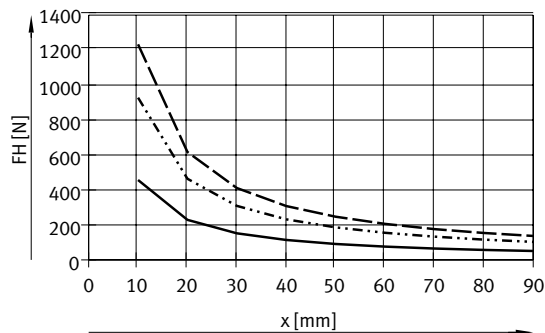

HGRT-40

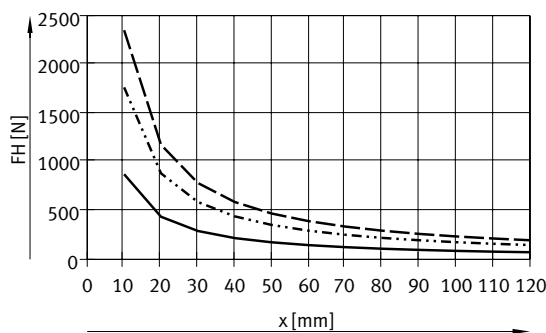

HGRT-50

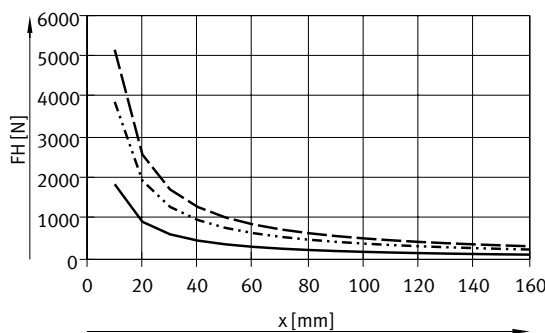

- 3 bar
- · - · - 6 bar
- - - 8 bar

Data sheet

Gripping force F_H per gripper jaw as a function of operating pressure and lever arm x

Gripping forces as a function of the operating pressure and the lever arm can be determined for the size using the following graph.

The gripping torque is not constant across the opening angle → page 12

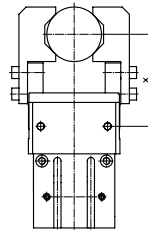

Internal gripping (opening)

HGRT-16

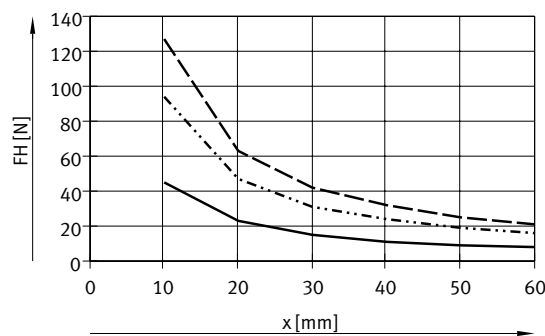

HGRT-20

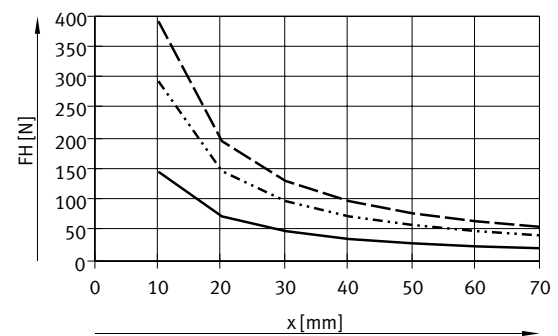

HGRT-25

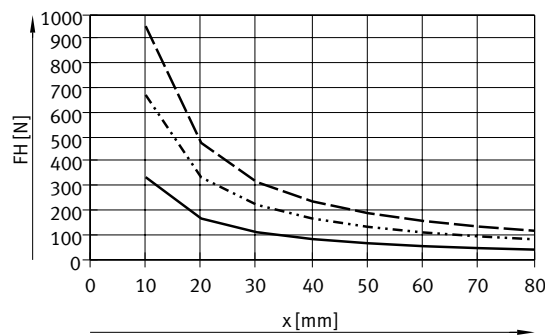

HGRT-32

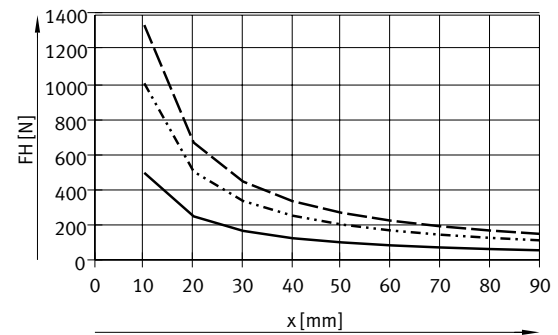

HGRT-40

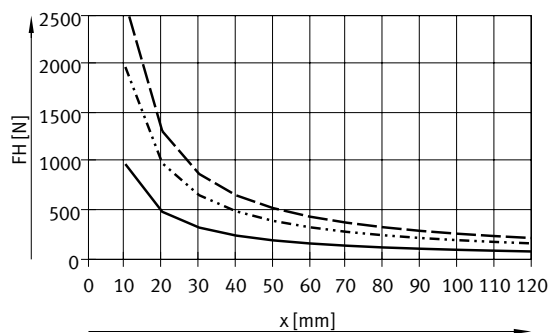

HGRT-50

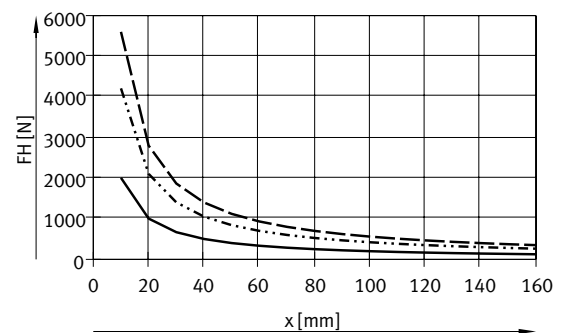

— 3 bar
 - · - · - 6 bar
 - - - 8 bar

Data sheet

Gripping force F_H per gripper jaw at 6 bar as a function of lever arm x and eccentricity a and b

The following formula must be used to calculate the lever arm x with eccentric gripping:

$$x = \sqrt{a^2 + b^2}$$

The gripping force F_H can be read from the graphs (→ page 10) using the calculated value x .

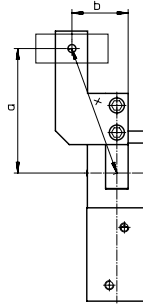

Calculation example

Given:

Distance $a = 45$ mm

Distance $b = 40$ mm

To be calculated:

The gripping force at 6 bar with a HGRT-40, used as an external gripper

Procedure: Calculating the lever arm x

$$x = \sqrt{45^2 + 40^2}$$

$$x = 60$$
 mm

The graph (→ page 10) gives a value for the gripping force $F_H = 300$ N.

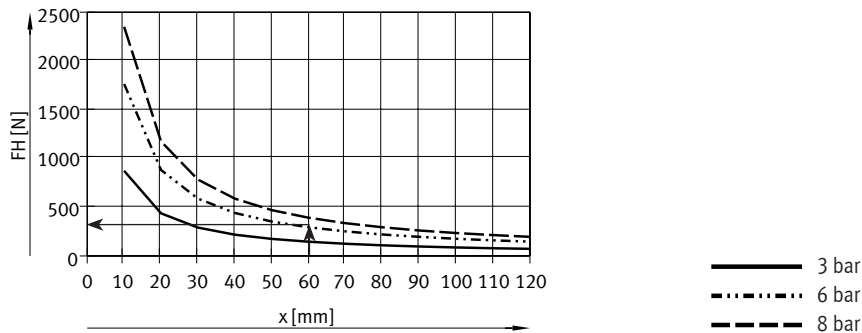

Torque curve M as a function of opening angle α

The drive principle of the gripper jaws means that the torque is not constant across the opening angle. The percentage of torque available in each case can be determined from the graph.

Opening angle of 0° means: parallel gripper jaw position

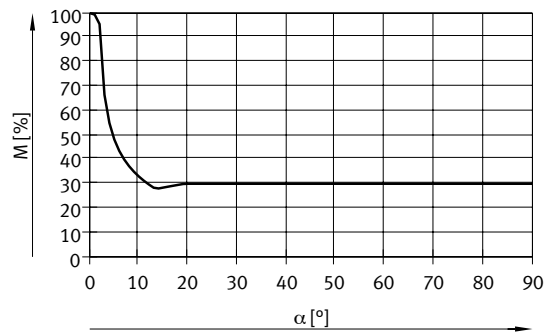

Data sheet

Spring torque M_F as a function of opening angle α

HGRT-16 ... 25

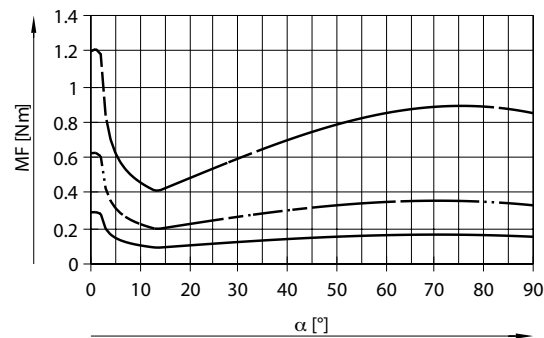

— HGRT-16-A-G2
 HGRT-20-A-G2
 - - - HGRT-25-A-G2

HGRT-32 ... 40

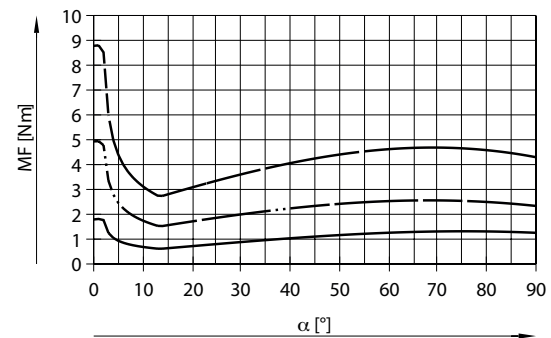

— HGRT-32-A-G2
 HGRT-40-A-G2
 - - - HGRT-50-A-G2

Determining the actual gripping torques $M_{Grtotal}$ for HGRT-...-G2 as a function of application

The radial gripper with integrated spring HGRT-...-G2 (closing gripping force retention) can be used as follows:

- Single-acting gripper
- Gripper with supplementary gripping force
- Gripper with gripping force retention

To calculate the available gripping torque $M_{Grtotal}$ (per gripper jaw), the data from the graphs for the gripping force F_H (→ page 10), the torque curve M (→ page 12) and the spring torque M_F (→ page 13) must be combined accordingly.

$$M_{Gr} = F_H \cdot x \cdot M \text{ [%]}$$

M_{Gr} Gripping torque
 F_H Gripping force
 x Lever arm
 M Torque curve

Application

Single-acting

- Gripping with spring force:
 $M_{Grtotal} = M_F$
- Gripping with pressure force:
 $M_{Grtotal} = M_{Gr} - M_F$

Supplementary gripping force

- Gripping with pressure and spring force:
 $M_{Grtotal} = M_{Gr} + M_F$

Gripping force retention

- Gripping with spring force:
 $M_{Grtotal} = M_F$

Data sheet

Dimensions

Download CAD data → www.festo.com

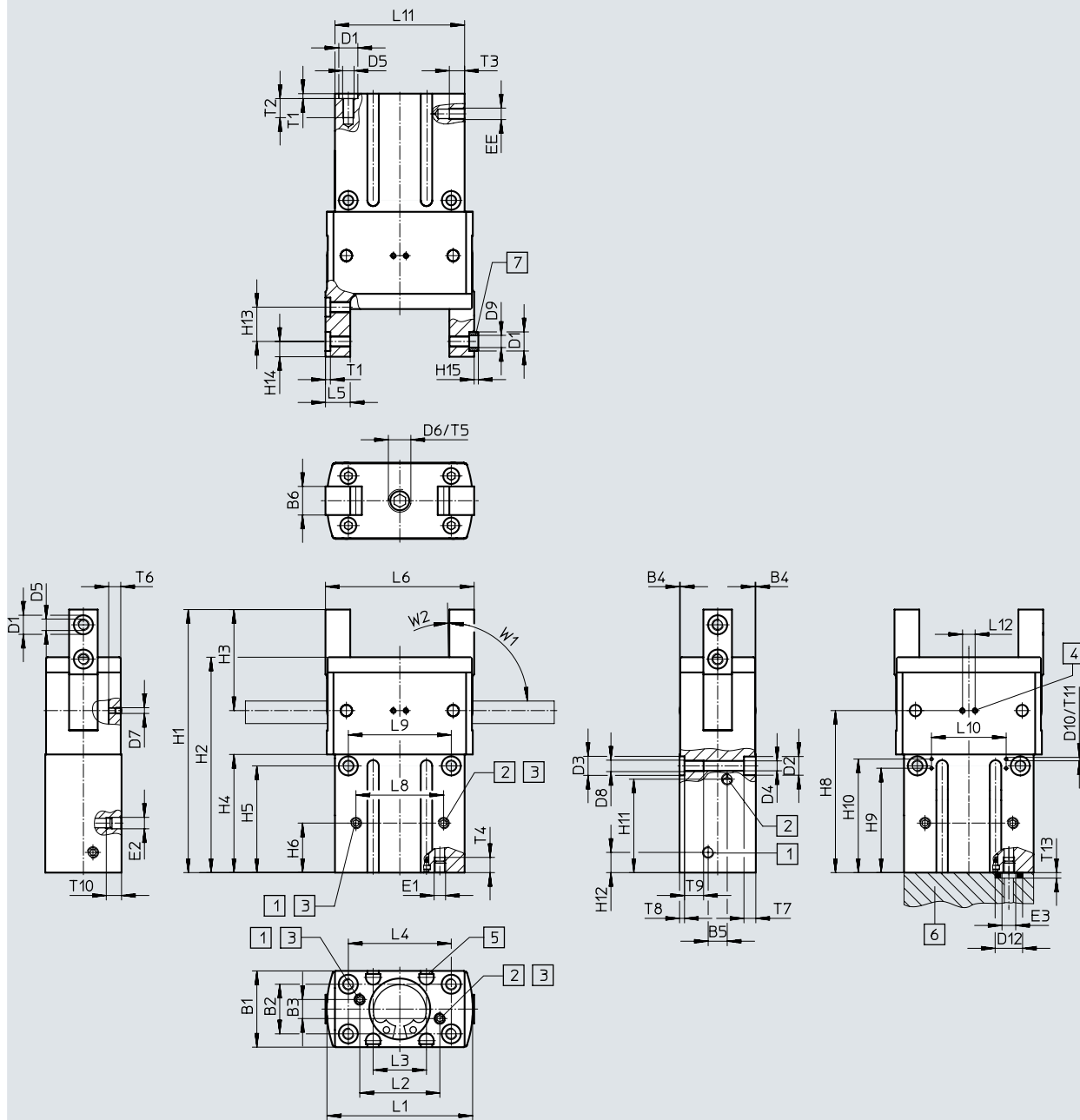

HGRT-32 ... 50

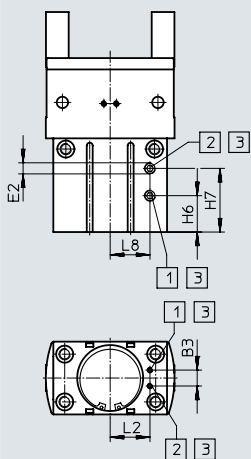

- [1] Supply port, opening
- [2] Supply port, closing
- [3] Alternative supply port, sealed on delivery
- [4] Sealing air, sealed on delivery
- [5] Sensor slot for proximity sensor
- [6] O-ring for radial gripper
HGRT-16 ... 25: $\varnothing 3 \times 1.5$
HGRT-32 ... 50: $\varnothing 5 \times 1.5$
- [7] Centring sleeves ZBH (4 included in the scope of delivery)

Data sheet

Size	B1	B2 ¹⁾	B3	B4	B5	B6	D1 ∅	D2 ∅	D3 ∅	D4 ∅	D5	D6	D7	D8	D9 ∅
[mm]	±0.05		±0.1	+0.05	±0.1	±0.05	H8	+0.1	H8						
16	20	13	5	0.2	5	7.5	5	4.9	5	2.6	M3	M6	–	M3	3.2
20	28	18	6	0.2	6	10	7	7.4	7	4.2	M5	M6	M3	M5	5.3
25	35	23	7	0.2	7	12.5	9	9.4	9	5.1	M6	M8	M5	M6	6.4
32	40	27	10	0.2	10	14.5	9	9.4	9	5.1	M6	M8	M5	M6	6.4
40	50	33	11	0.2	11	18	12	10.4	12	6.8	M8	M8	M5	M8	10.3
50	64	42	14	0.2	14	22.5	15	13.5	15	8.5	M10	M12	M5	M10	12.4

Size	D10	D12	EE	E1	E2	E3	H1		H2		H3	H4		H5	
							±0.05	-G ±0.05	±0.05	-G ±0.05		±0.1	±0.1	-G ±0.1	±0.1
16	–	6	M3	M3	M3	M3	69	77.5	56.5	65	26.5	31	39.5	28	36.5
20	–	6	M5	M3	M3	M3	88.5	97.5	71	80	35.1	39	48	34.5	43.5
25	M3	6	M5	M3	M3	M3	109	120	88	99	42.5	48.3	59.3	42.5	53.5
32	M3	8	M5	M5	M5	M5	125	137	102	114	49	54.7	66.7	49	61
40	M3	8	G1/8	M5	G1/8	M5	154.6	172.6	122	140	63.6	65.5	83.5	58	76
50	M3	8	G1/8	M5	G1/8	M5	193.5	215.5	153	175	79.5	82.4	104.4	73	95

Size	H6		H7		H8		H9		H10		H11		H12	H13 ¹⁾
	±0.1	-G ±0.1	±0.1	-G ±0.1		-G	±0.1	-G ±0.1	±0.1	-G ±0.1	±0.1	-G ±0.1		
16	13	13	–	–	–	–	–	–	–	–	24.5	33	5.3	9
20	16	16	–	–	52.5	61.5	–	–	–	–	29	38	6	12
25	19.5	19.5	–	–	65.5	76.5	28	39	36	47	36	47	7.6	14
32	20	20	35.5	46.5	75.5	87.5	34.5	46.5	42.5	54.5	42.4	54.2	8.1	16
40	26	29	45	56.5	90	108	47	65	55	73	48	64.5	9.7	20
50	32	32	56	70	113	135	72	94	80	102	62	80	13.5	25

Size	H14 ¹⁾	H15	L1	L2	L3	L4 ¹⁾	L5	L6	L8	L9 ¹⁾	L10	L11	L12	T1
[mm]		-0.3	±0.05		+0.1		±0.05	±0.5	±0.1		±0.1	±0.1		+0.1
16	4	1.2	38.3	21±0.1	14	27	6.5	39	23	27	–	34	–	1.3
20	5	1.4	49.9	30±0.1	17	34	9	50.4	30	34	–	44	11	1.6
25	6	1.9	61.1	39±0.1	22	42	11	61.2	39	41	33	54	11	2.1
32	7	1.9	72.2	22.5 ^{+0.1}	24	51	12	72.2	22.5	48	41	64	11	2.1
40	9	2.4	90.3	28 ^{+0.1}	32	63	16.5	90.8	28	62	47	80	11	2.6
50	11	2.9	113.2	35 ^{+0.1}	36	80	20	113	35	78	59	100	11	3.1

Size	T2		T3	T4	T5	T6	T7	T8	T9	T10	T11	T12	T13	W1	W2
	min.	-G min.													
16	5	5	4	4	4	–	3.1	1.3	5	4	–	–	1.2	90	1
20	8.5	8	5	4	5	4.3	4.1	1.6	8	4	–	4	1.2	90	1
25	10	10	5	4.5	6	5.8	5.1	2.1	10	4.5	5.5	–	1.2	90	1
32	9.5	9.5	5	5	7	6.3	5.2	2.1	9.5	5	5.5	–	1.2	90	1
40	14.5	14.5	8.5	5	8	7.8	6.2	2.6	12.5	8.5	5.5	–	1.2	90	1
50	15	15	8.5	5	10	10.55	8.1	3.1	15	8.5	5.5	–	1.2	90	1

1) Tolerance for centring hole ±0.02 mm
Tolerance for thread ±0.1 mm

Data sheet

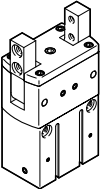
Ordering data	Size	Double-acting without compression spring		Single-acting or with gripping force retention	
		Part no.	Type	Part no.	Type
	[mm]			Closing	
	16	563904	HGRT-16-A	563905	HGRT-16-A-G2
	20	563906	HGRT-20-A	563907	HGRT-20-A-G2
	25	563908	HGRT-25-A	563909	HGRT-25-A-G2
	32	563910	HGRT-32-A	563911	HGRT-32-A-G2
	40	563912	HGRT-40-A	563913	HGRT-40-A-G2
	50	563914	HGRT-50-A	563915	HGRT-50-A-G2

Ordering data – Sets of wearing parts		
Size	Part no.	Type
[mm]		
16	1459481	HGRT-16
20	1459482	HGRT-20
25	1459483	HGRT-25
32	1459484	HGRT-32
40	1459485	HGRT-40
50	1459486	HGRT-50



Accessories

Adapter kit
DHAA

Material:
Wrought aluminium alloy
Free of copper and PTFE
RoHS-compliant

**Note**

The kit includes the individual mounting interface as well as the necessary mounting material.

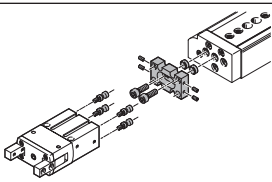
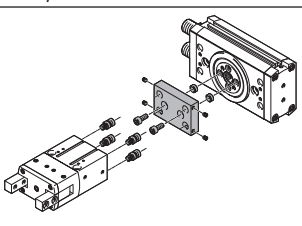
Permissible drive/gripper combinations with adapter kit						Download CAD data → www.festo.com	
Combination	Actuator Size	Gripper Size	Mounting option		Adapter kit CRC ¹⁾	Part no.	Type
							
	DGSL	HGRT			2		
	8, 10	16	■	■		1273902	DHAA-G-G6-8-B11-16
	12, 16	16	■	■		1467524	DHAA-G-G6-12-B11-16
	12, 16	20	■	■		1278364	DHAA-G-G6-12-B11-20
	20, 25	25	■	■		1468307	DHAA-G-G6-20-B11-25
	25	32	■	■	1280494	DHAA-G-G6-25-B11-32	
	DRRD	HGRT			2		
	16	16	■	■		2185606	DHAA-G-Q11-16-B11-16
	20	20	■	■		2184467	DHAA-G-Q11-20-B11-20
	25	25	■	■		1741183	DHAA-G-Q11-25-B11-25
	25	32	■	■		1743177	DHAA-G-Q11-25-B11-32
	32	25	■	■		2184080	DHAA-G-Q11-32-B11-25
	32	32	■	■		2184322	DHAA-G-Q11-32-B11-32
	32	40	■	■		2184652	DHAA-G-Q11-32-B11-40
	35	40	■	■		2185436	DHAA-G-Q11-35-B11-40

1) Corrosion resistance class CRC 2 to Festo standard FN 940070

Moderate corrosion stress. Indoor applications in which condensation can occur. External visible parts with primarily decorative surface requirements which are in direct contact with a normal industrial environment.

Accessories



Adapter kit
DHAA, HAPG

Material:
Wrought aluminium alloy
Free of copper and PTFE
RoHS-compliant

 **Note**
The kit includes the individual mounting interface as well as the necessary mounting material.

Permissible drive/gripper combinations with adapter kit

Download CAD data → www.festo.com

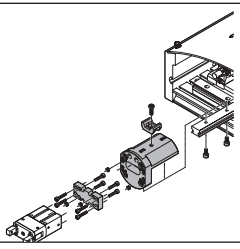
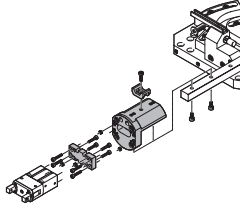
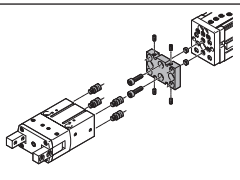
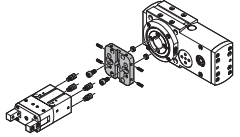
Combination	Actuator Size	Gripper Size	Mounting option		Adapter kit CRC ¹⁾	Part no.	Type
							
	16	16	■	–	2	1274347	DHAA-G-H4-16-B11-16
			■	–		540882	HAPG-71-B
	25	16	■	–		1274347	DHAA-G-H4-16-B11-16
			■	–		540883	HAPG-72-B
	12, 16	16	■	–	2	1274347	DHAA-G-H4-16-B11-16
			■	–		540882	HAPG-71-B
		45, 55	20	■		■	2
75				25	■	■	
		25	25		■	■	
75				32	■	■	
	20	20	■	■	2	1465263	DHAA-G-Q5-20-B11-20
			25, 32	25		■	■
	25, 32	32				■	■
			■	■			

1) Corrosion resistance class CRC 2 to Festo standard FN 940070

Moderate corrosion stress. Indoor applications in which condensation can occur. External visible parts with primarily decorative surface requirements which are in direct contact with a normal industrial environment.

Accessories

Stroke reducing kit HGRT-HR

Material:

Screw: Steel

Lock nut: Case-hardened steel

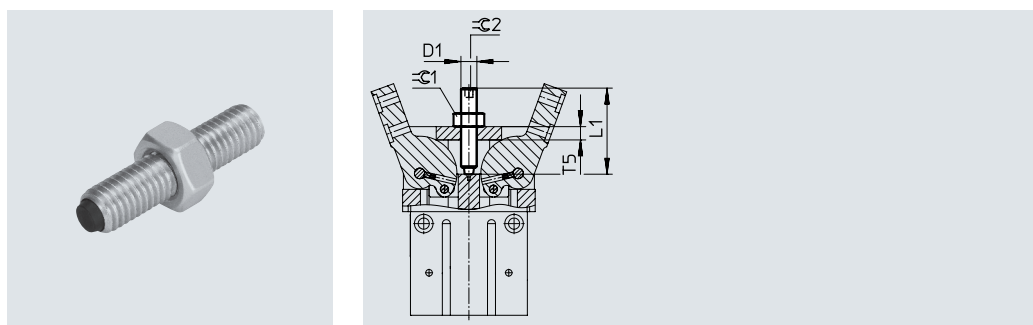

Dimensions and ordering data									
For size [mm]	D1	L1	T5	∅1	∅2	Adjustable end-position range [mm]	Weight [g]	Part no.	Type
16	M6	26	4	10	3	20	7	564296	HGRT-HR-16
20	M6	31	5	10	3	25	9	564297	HGRT-HR-20
25	M8	36	6	13	4	30	18	564298	HGRT-HR-25
32	M8	41	7	13	4	35	20	564299	HGRT-HR-32
40	M8	51	8	13	4	45	24	564300	HGRT-HR-40
50	M12	61	10	19	6	50	66	564301	HGRT-HR-50

Sensor bracket DASI

Material:

DASI-B10-25-S8: Polyamide

DASI-B10-40-S12: Aluminium

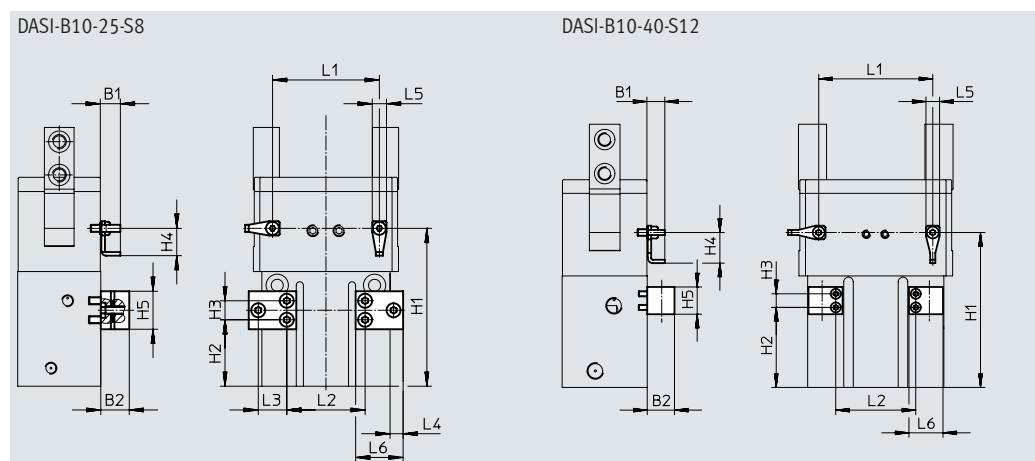
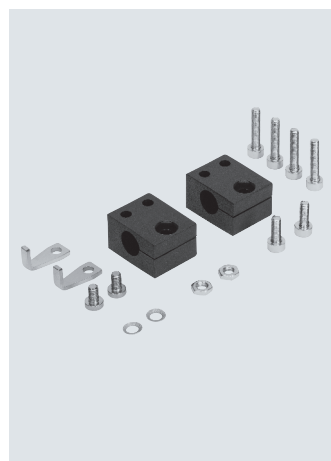

Dimensions and ordering data				
For type [mm]	H1 ±0.02	H2 ±0.1	L1 ±0.01	L2
HGRT-25-A	66.5	28	45	33
HGRT-25-A-G2	77.5	39	45	33
HGRT-32-A	76	34.5	53	64
HGRT-32-A-G2	88	46.5	53	64
HGRT-40-A	91	47	67	47
HGRT-40-A-G2	109	65	67	47
HGRT-50-A	114	72	84	59
HGRT-50-A-G2	136	94	84	59

For size [mm]	B1	B2	H3 ±0.1	H4	H5	L3 ±0.1	L4	L5	L6 ±0.2	Weight [g]	Part no.	Type
25, 32	8.45	12	8	11.5	16	12	5.5	6	20	39	564311	DASI-B10-25-S8
40, 50	10.5	16	8	18	16	-	-	8	20	18	564312	DASI-B10-40-S12



Accessories

Ordering data – Centring sleeves		Data sheets → Internet: zbh		
	For size [mm]	Part no.	Type	PU ¹⁾
	16	8146543	ZBH-5-B	10
	20	8146544	ZBH-7-B	
	25, 32	8137184	ZBH-9-B	
	40	8137185	ZBH-12-B	
	50	191409	ZBH-15	

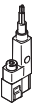
1) Packaging unit

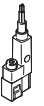
Proximity sensor for size 16 ... 32		Data sheets → Internet: smt				
Ordering data – Proximity sensor for C-slot, magneto-resistive						
	Type of mounting	Electrical connection, outlet direction of connection	Switching output	Cable length [m]	Part no.	Type
N/O contact						
	Inserted in the slot lengthwise	Cable, 3-wire, lateral	PNP	2.5	547862	SMT-10G-PS-24V-E-2.5Q-OE
		Plug M8x1, 3-pin, lateral		0.3	547863	SMT-10G-PS-24V-E-0.3Q-M8D
		Cable, 3-wire, lateral	NPN	2.5	8065030	SMT-10G-NS-24V-E-2.5Q-OE
		Plug M8x1, 3-pin, lateral		0.3	8065029	SMT-10G-NS-24V-E-0.3Q-M8D

Proximity sensor for size 40 ... 50		Data sheets → Internet: smt				
Ordering data – Proximity sensor for T-slot, magneto-resistive						
	Type of mounting	Electrical connection, outlet direction of connection	Switching output	Cable length [m]	Part no.	Type
N/O contact						
	Inserted in the slot lengthwise	Cable, 3-wire, lateral	PNP	2.5	547859	SMT-8G-PS-24V-E-2.5Q-OE
		Plug M8x1, 3-pin, lateral		0.3	547860	SMT-8G-PS-24V-E-0.3Q-M8D
		Cable, 3-wire, lateral	NPN	2.5	8065028	SMT-8G-NS-24V-E-2.5Q-OE
		Plug M8x1, 3-pin, lateral		0.3	8065027	SMT-8G-NS-24V-E-0.3Q-M8D



Ordering data – Connecting cables		Data sheets → Internet: nebu			
	Electrical connection, left	Electrical connection, right	Cable length [m]	Part no.	Type
	Straight socket, M8x1, 3-pin	Cable, open end, 3-wire	2.5	541333	NEBU-M8G3-K-2.5-LE3
			5	541334	NEBU-M8G3-K-5-LE3
	Angled socket, M8x1, 3-pin	Cable, open end, 3-wire	2.5	541338	NEBU-M8W3-K-2.5-LE3
			5	541341	NEBU-M8W3-K-5-LE3

Accessories

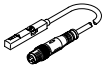
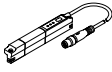

Position transmitter

The position transmitter continuously senses the position of the piston. It has an analogue output with an output signal relative to the piston position.

Ordering data – Position transmitter for T-slot								Data sheets → Internet: position transmitter	
	For \varnothing	Position measuring range	Analogue output		Type of mounting	Electrical connection	Cable length [m]	Part no.	Type
			[V]	[mA]					
	40	0 ... 40	0 ... 10	–	Inserted in the slot from above	Plug M8x1, 4-pin, in-line	0.3	553744	SMAT-8M-U-E-0.3-M8D
	40, 50	0 ... 50	–	4 ... 20	Inserted in the slot from above	Plug M8x1, 4-pin, in-line	0.3	1531265	SDAT-MHS-M50-1L-SA-E-0.3-M8

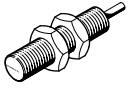
Ordering data – Connecting cables					Data sheets → Internet: nebu
	Electrical connection, left	Electrical connection, right	Cable length [m]	Part no.	Type
	Straight socket, M8x1, 4-pin	Cable, open end, 4-wire	2.5	541342	NEBU-M8G4-K-2.5-LE4
			5	541343	NEBU-M8G4-K-5-LE4
	Angled socket, M8x1, 4-pin	Cable, open end, 4-wire	2.5	541344	NEBU-M8W4-K-2.5-LE4
			5	541345	NEBU-M8W4-K-5-LE4

Ordering data – Proximity sensors, inductive, for sensor bracket DASI					Data sheets → Internet: sien
	Thread	Contact	Connection	Part no.	Type
	For DASI-B10-25-S8				
	M8	N/O contact	Cable, 2.5 m	150386	SIEN-M8B-PS-K-L
			Plug	150387	SIEN-M8B-PS-S-L
	For DASI-B10-40-S12				
M12	N/O contact	Cable, 2.5 m	150402	SIEN-M12B-PS-K-L	
		Plug	150403	SIEN-M12B-PS-S-L	

Ordering data – Connecting cables					Data sheets → Internet: nebu
	Electrical connection, left	Electrical connection, right	Cable length [m]	Part no.	Type
	Straight socket, M8x1, 3-pin	Cable, open end, 3-wire	2.5	541333	NEBU-M8G3-K-2.5-LE3
			5	541334	NEBU-M8G3-K-5-LE3
	Angled socket, M8x1, 3-pin	Cable, open end, 3-wire	2.5	541338	NEBU-M8W3-K-2.5-LE3
			5	541341	NEBU-M8W3-K-5-LE3

Festo - Your Partner in Automation



1 Festo Inc.
5300 Explorer Drive
Mississauga, ON L4W 5G4
Canada

Festo Customer Interaction Center
Tel: 1 877 463 3786
Fax: 1 877 393 3786
Email: customer.service.ca@festo.com



2 Festo Pneumatic
Av. Ceylán 3,
Col. Tequesquináhuac
54020 Tlalnepantla,
Estado de México

Multinational Contact Center
01 800 337 8669
ventas.mexico@festo.com



3 Festo Corporation
1377 Motor Parkway
Suite 310
Islandia, NY 11749

Festo Customer Interaction Center
1 800 993 3786
1 800 963 3786
customer.service.us@festo.com



4 Regional Service Center
7777 Columbia Road
Mason, OH 45040

Connect with us



www.festo.com/socialmedia



www.festo.com

Subject to change