

## Parallel grippers HGPD, sealed

**FESTO**

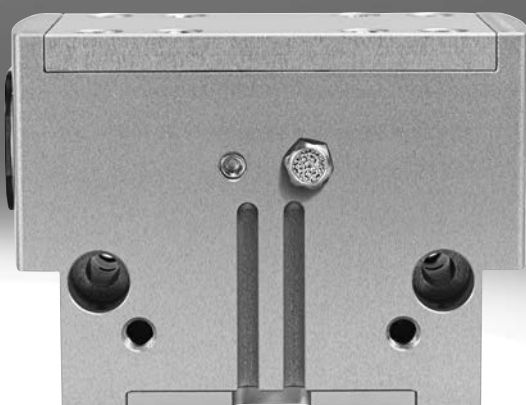

## Key features

### At a glance

#### General

The fully encapsulated gripper kinematics enable the gripper to be used in extremely harsh ambient conditions. The sturdy and precise kinematics provide maximum torque resistance and a long service life.

The force generated by the linear motion is translated into the gripper jaw movement via a wedge mechanism with force-guided motion.

This also guarantees synchronous movement of the gripper jaws. The virtually backlash-free plain-bearing guide is realised using ground-in gripper jaws.

#### Flexible range of applications

- Can be used as a double-acting and single-acting gripper
- Compression spring for supplementing or retaining the gripping forces
- Suitable for external and internal gripping

### The technology in detail

#### Gripper closed

#### Gripper open

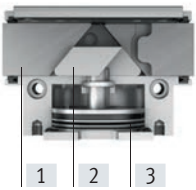

- [1] Gripper jaw
- [2] Wedge with forced guidance
- [3] Piston with magnet

### Note

Engineering software

Gripper selection

→ [www.festo.com](http://www.festo.com)

### Wide range of supply ports

Directly from the front

Via adapter plate from underneath

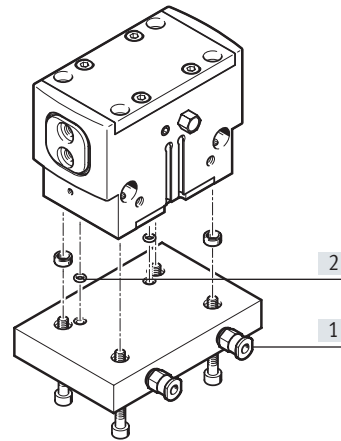
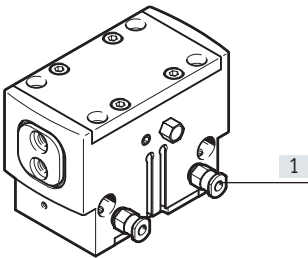

- [1] Supply ports
- [2] O-rings

### Other connections

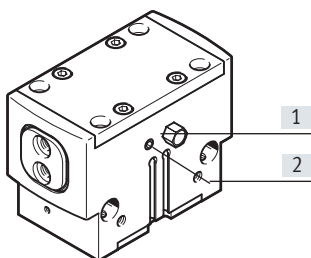

- [1] Exhaust hole or sealing air connection
- [2] Port for lubrication nipple

### Use in harsh ambient conditions

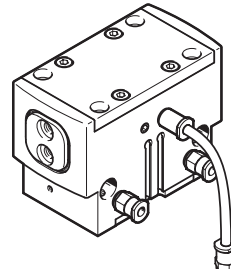

When using the gripper in humid environments or with liquid/gaseous media, make sure that the filter is installed in a neutral environment. The same applies to unused supply ports when operating the gripper as a single-acting gripper.

## Key features

### Mounting options

Direct mounting  
from above

Via adapter plate  
from underneath

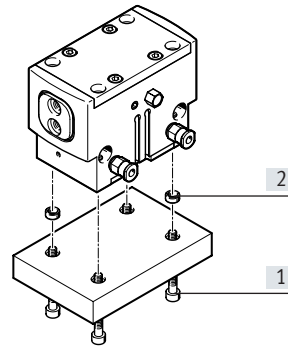
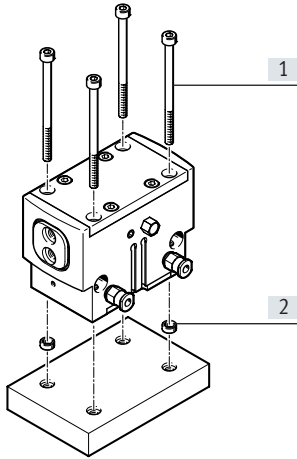

[1] Mounting screws  
[2] Centring sleeves

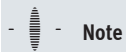

#### Note

These grippers are not suitable or are of limited suitability for the following application examples:

Not suitable for:

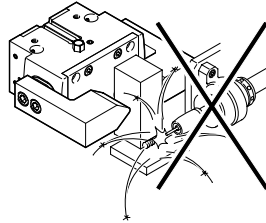

- Welding spatter

Of limited suitability for:

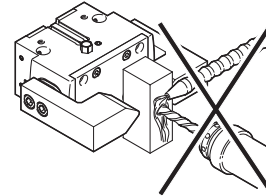

- Aggressive media: only possible after consultation with Festo

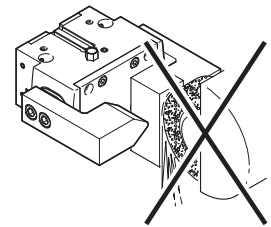

- Grinding dust

## Type codes and peripherals overview

001	Series	
HGPD	Parallel gripper, sealed	

002	Size	
16	16	
20	20	
25	25	
35	35	
40	40	
50	50	
63	63	
80	80	

003	Position sensing	
A	For proximity sensor	

004	Gripping force backup	
	None	
G1	Opening	
G2	N/O contact	

### Peripherals overview

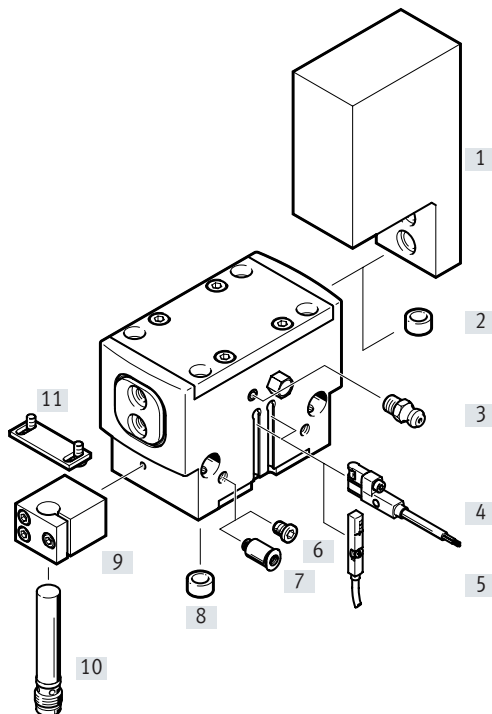

### System product for handling and assembly technology

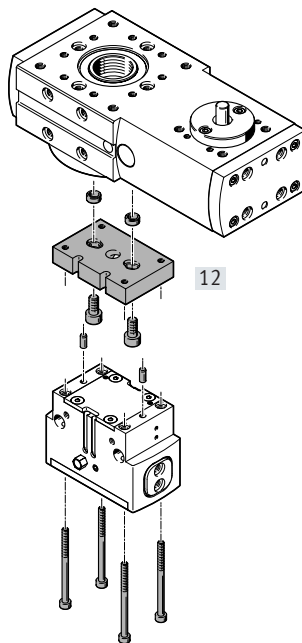

### Proportional-pressure regulator VPPM

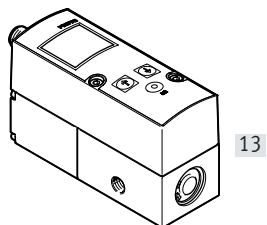

## Peripherals overview

Accessories		
Type	Description	→ Page/Internet
[1] Gripper jaw blank BUB-HGPD	Unmachined part specially matched to the gripper jaws for custom production of gripper fingers	20
[2] Centring pin/sleeve ZBS/ZBH	<ul style="list-style-type: none"> <li>For centring the gripper jaw blanks/gripper fingers on the gripper jaws</li> <li>4 centring pins/sleeves included in the scope of delivery of the gripper</li> </ul>	21
[3] Lubrication nipple	Included in the scope of delivery of the gripper	-
[4] Proximity switch SMT-8G/-10G	<ul style="list-style-type: none"> <li>For sensing the piston position</li> <li>Proximity switch does not project past the housing at the bottom</li> </ul>	22
[6] Blanking plug B	For sealing the supply ports when using the lower supply ports	21
[7] Push-in fitting QS	For connecting tubing with standard O.D.	qs
[8] Centring sleeve ZBH	For centring the gripper during mounting	21
[9] Sensor bracket DASI	Terminal block for securing the proximity switches SIEH or SIEN	21
[10] Proximity switch SIEH/SIEN	For sensing the piston position	22
[11] Sensor bracket DASI	Switch lug for sensing the gripper jaw position. Mounted on the gripper jaw blank	21
[12] Adapter kit DHAA, HAPG	Connecting plate between drive and gripper	17
[13] Proportional-pressure regulator VPPM	For infinite adjustment of the gripping force	vppm

## Data sheet

Double-acting  
HGPD-...-A

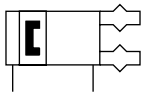

with gripping force retention

HGPD-...-G1 (opening)

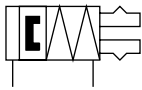

HGPD-...-G2 (closing)



⌀ - Size  
16 ... 80

— - Total stroke  
6 ... 40 mm

 [www.festo.com](http://www.festo.com)

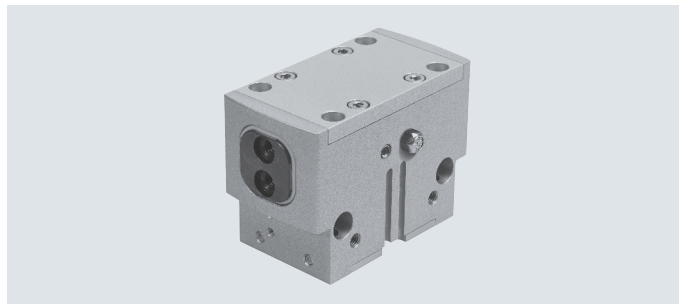

General technical data		16	20	25	35	40	50	63	80	
Size		16	20	25	35	40	50	63	80	
Design		Wedge mechanism Force-guided motion								
Mode of operation		Double-acting								
Gripper function		Parallel								
Number of gripper jaws		2								
Max. mass per gripper finger <sup>1)</sup>	[g]	25	57	138	278	445	813	1340	2170	
Stroke per gripper jaw	[mm]	3	4	6	8	10	12	16	20	
Pneumatic connection		M5	M5	M5	M5	M5	G1/8	G1/8	G1/4	
Pneumatic connection, sealing air		M3	M3	M5	M5	M5	M5	M5	M5	
Pneumatic connection, lubrication nipple		M3	M3	M5	M5	M5	M5	M5	M5	
Repetition accuracy <sup>2)</sup>	[mm]	≤ 0.03	≤ 0.04		≤ 0.05					
Max. interchangeability	[mm]	≤ ±0.2								
Max. operating frequency	[Hz]	≤ 3					≤ 2			
Rotational symmetry	[mm]	< ∅ 0.2								
Position sensing		Via proximity switch, position transmitter								
Type of mounting		Via through-hole and dowel pin/centring sleeve Via female thread and dowel pin/centring sleeve								
Mounting position		Any								

1) Applies to unthrottled operation

2) Under constant exposure to operating conditions, end-position drift occurs in the direction of movement of the gripper jaws, at 100 consecutive strokes

### Operating and environmental conditions

Min. operating pressure		
HGPD-...-A	[bar]	3
HGPD-...-A-G	[bar]	4
Max. operating pressure	[bar]	8
Operating pressure for sealing air	[bar]	0 ... 0.5
Operating medium		Compressed air to ISO 8573-1:2010 [7:4:4]
Note on the operating/pilot medium		Lubricated operation possible (in which case lubricated operation will always be required)
Ambient temperature <sup>1)</sup>	[°C]	+5 ... +60
Degree of protection		IP65
Corrosion resistance class CRC <sup>2)</sup>		2

1) Note operating range of proximity switches

2) Corrosion resistance class CRC 2 to Festo standard FN 940070

Moderate corrosion stress. Indoor applications in which condensation can occur. External visible parts with primarily decorative surface requirements which are in direct contact with a normal industrial environment.

## Data sheet

Weight [g] Size	16	20	25	35	40	50	63	80
HGPD-...-A	100	163	327	572	1044	1766	3365	6252
HGPD-...-A-G	117	182	361	682	1223	2150	3998	7484

## Materials

## Sectional view

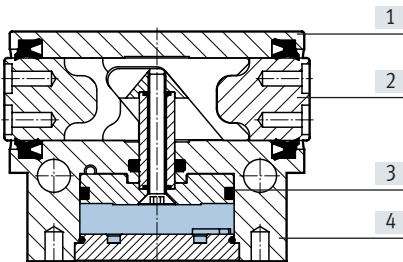

Size	16	20	25	35	40	50	63	80
[1] Cover cap	High-alloy stainless steel							
[2] Gripper jaw	Hardened steel							
[3] Piston	Hard-anodised aluminium							
[4] Housing	Anodised aluminium							
- Seals	Nitrile rubber							
- Note on materials	Free of copper and PTFE		-					
	RoHS-compliant							

## Gripping force [N] at 6 bar

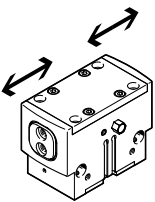

Size	16	20	25	35	40	50	63	80	
<b>Gripping force per gripper jaw</b>									
HGPD-...-A	Opening	54	80	144	291	315	472	967	1961
	Closing	47	75	133	267	267	447	928	1858
<b>Total gripping force</b>									
HGPD-...-A	Opening	107	159	288	581	630	944	1935	3922
	Closing	94	150	266	534	598	894	1856	3716

## Data sheet

### Characteristic load values at the gripper jaws

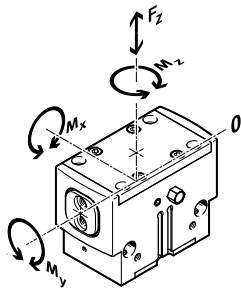

The indicated permissible forces and torques apply to a single gripper jaw. They include the lever arm, additional weight forces due to the workpiece or external gripper fingers and acceleration forces occurring during movement.

The zero coordinate line (gripper jaw guide) must be taken into consideration when calculating torques.

Size		16	20	25	35	40	50	63	80
Max. permissible force $F_z$	[N]	150	250	500	750	1200	2000	3000	6000
Max. permissible torque $M_x$	[Nm]	8	12	30	40	70	90	120	170
Max. permissible torque $M_y$	[Nm]	4	7	25	30	45	60	80	130
Max. permissible torque $M_z$	[Nm]	3	6	15	25	35	50	65	110

### Mass moments of inertia [kgcm<sup>2</sup>]

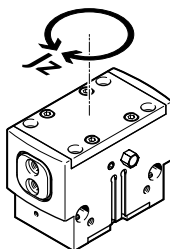

Mass moment of inertia of the parallel gripper in relation to the central axis, without external gripper fingers, without load.

Size		16	20	25	35	40	50	63	80
HGPD-...-A		0.22	0.40	1.32	3.56	10.10	26.19	80.33	236.48
HGPD-...-A-G		0.27	0.52	1.72	4.88	14.09	36.74	116.19	319.95

### Gripper jaw backlash

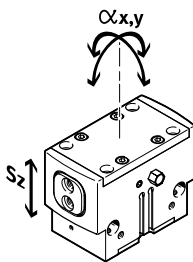

The plain-bearing guide used in the grippers means that there is backlash between the gripper jaws and the housing. The backlash values listed in the table have been calculated based on the traditional accumulative tolerance method.

Size		16	20	25	35	40	50	63	80
Max. gripper jaw backlash $S_z$	[mm]	0.02							
Max. gripper jaw angular backlash $\alpha_x, \alpha_y$	[°]	0.1							



Data sheet

Opening and closing times [ms] at 6 bar

Without external gripper fingers

With external gripper fingers

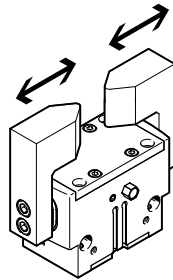
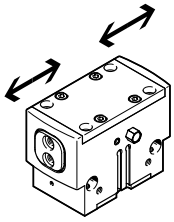

The indicated opening and closing times [ms] were measured at room temperature at an operating pressure of 6 bar with a horizontally mounted gripper without additional gripper fingers. The grippers must be throttled for larger masses [g]. Opening and closing times must then be adjusted accordingly.

Size		16	20	25	35	40	50	63	80
<b>Without external gripper fingers</b>									
HGPD-...-A	Opening	15	28	29	33	73	90	150	214
	Closing	17	31	35	37	77	100	162	218
HGPD-...-A-G1	Opening	15	13	24	31	73	85	170	235
	Closing	32	25	51	62	157	176	328	353
HGPD-...-A-G2	Opening	30	35	48	50	143	170	294	379
	Closing	15	18	28	36	71	87	185	240
<b>With external gripper fingers (as a function of the mass per gripper finger)</b>									
HGPD-...	50 g	20	-	-	-	-	-	-	-
	100 g	28	26	-	-	-	-	-	-
	200 g	40	37	30	-	-	-	-	-
	300 g	-	46	37	34	-	-	-	-
	400 g	-	-	43	40	46	-	-	-
	500 g	-	-	-	55	52	-	-	-
	600 g	-	-	-	-	57	-	-	-
	800 g	-	-	-	-	66	125	-	-
	1000 g	-	-	-	-	-	133	-	-
	1200 g	-	-	-	-	-	140	-	-
	1500 g	-	-	-	-	-	-	183	-
	1800 g	-	-	-	-	-	-	201	-
	2000 g	-	-	-	-	-	-	211	259
	2200 g	-	-	-	-	-	-	-	272
	2400 g	-	-	-	-	-	-	-	284

## Data sheet

### Gripping force $F_H$ per gripper jaw as a function of operating pressure and lever arm $x$

The gripping forces as a function of the operating pressure and lever arm can be determined from the following graphs.

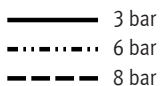
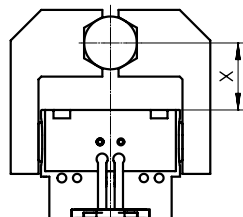

**Note**  
 Engineering software  
 Gripper selection  
 → [www.festo.com](http://www.festo.com)

### External gripping (closing)

HGPD-16-A

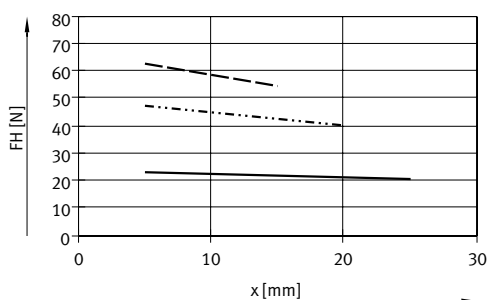

HGPD-20-A

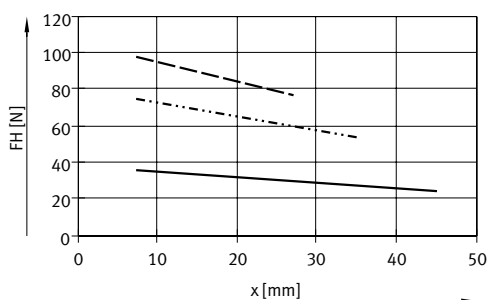

HGPD-25-A

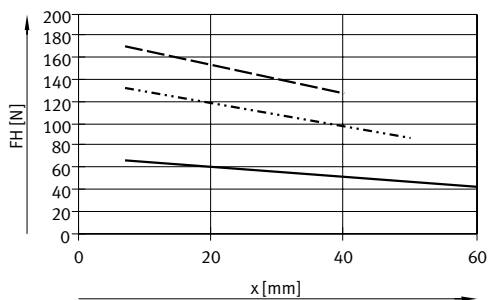

HGPD-35-A

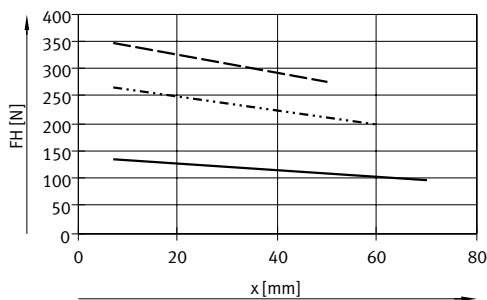

HGPD-40-A

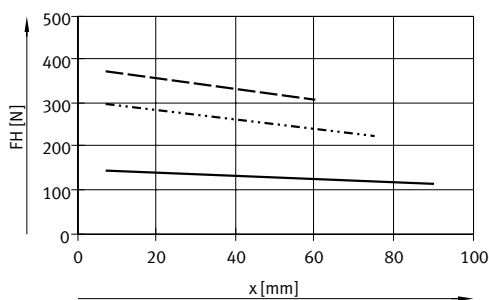

HGPD-50-A

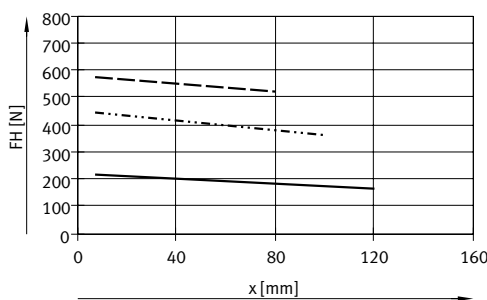

HGPD-63-A

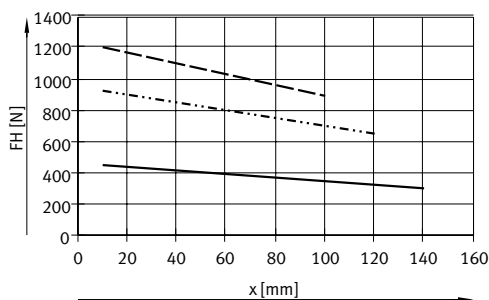

HGPD-80-A

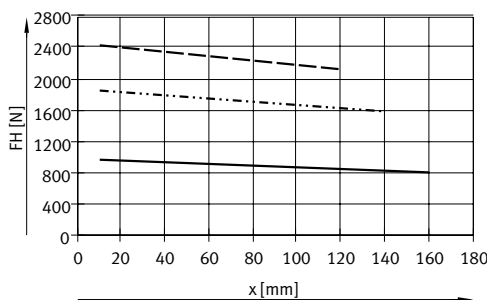

## Data sheet

### Gripping force $F_H$ per gripper jaw as a function of operating pressure and lever arm $x$

The gripping forces as a function of the operating pressure and lever arm can be determined from the following graphs.

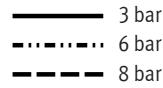
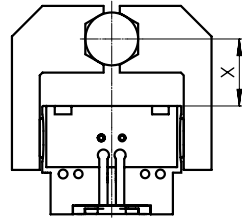

**Note**  
 Engineering software  
 Gripper selection  
 → [www.festo.com](http://www.festo.com)

### Internal gripping (opening)

HGPD-16-A

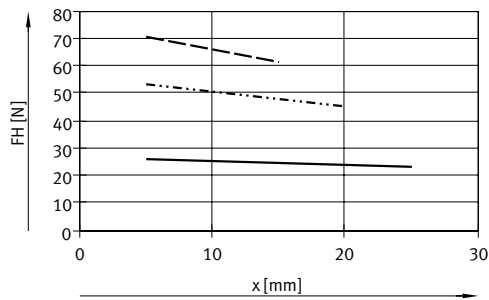

HGPD-20-A

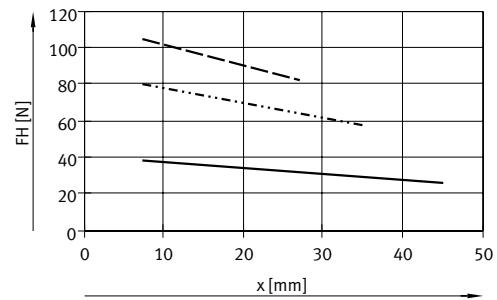

HGPD-25-A

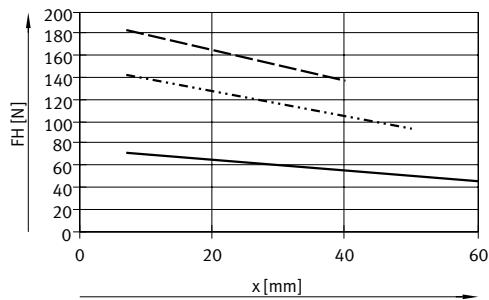

HGPD-35-A

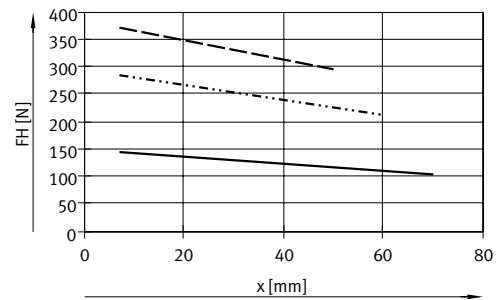

HGPD-40-A

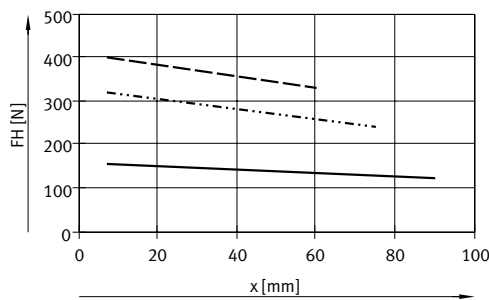

HGPD-50-A

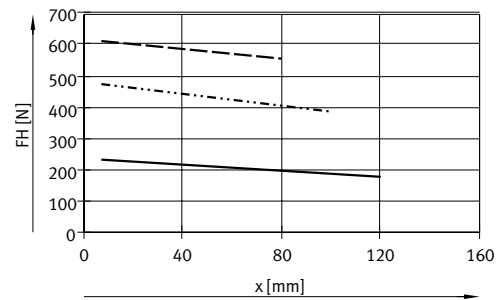

HGPD-63-A

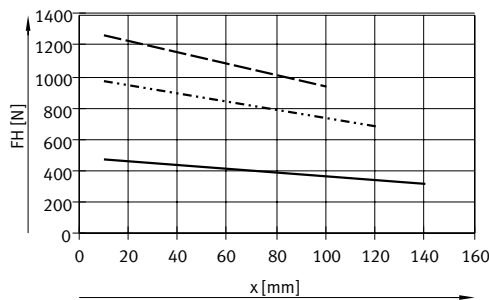

HGPD-80-A

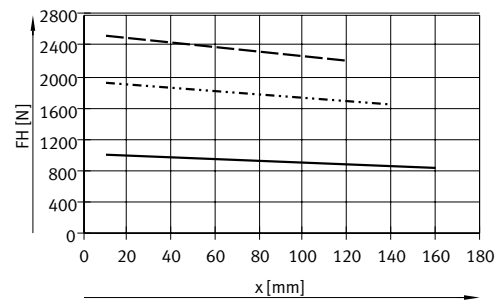

## Data sheet

### Gripping force $F_H$ per gripper jaw at 6 bar as a function of lever arm $x$ and eccentricity $a$ and $b$

The following formula must be used to calculate the lever arm  $x$  with eccentric gripping:

$$x = \sqrt{a^2 + b^2}$$

The gripping force  $F_H$  can be read from the graphs (→ page 10) using the calculated value  $x$ .

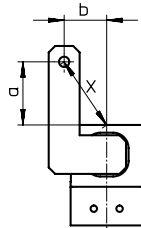

### Calculation example

Assuming:

Distance  $a = 45$  mm

Distance  $b = 40$  mm

Required:

The gripping force at 6 bar with an HGPD-40, used as an external gripper

Procedure: Calculating the lever arm  $x$

$$x = \sqrt{45^2 + 40^2}$$

$$x = 60$$
 mm

The graph (→ page 10) gives a value of  $F_H = 240$  N for the gripping force.

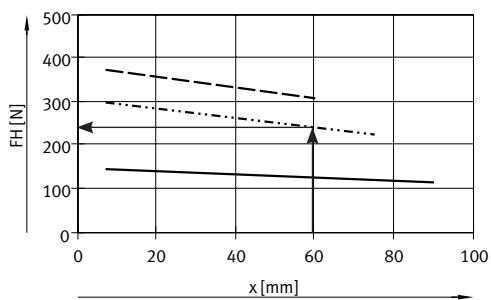

## Data sheet

### Spring force $F_F$ as a function of size and gripper jaw stroke $l$

Gripping force retention for HGPD-...-G...

The spring forces  $F_F$  as a function of gripper jaw stroke  $l$  can be determined from the following graph.

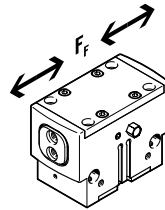

#### HGPD-16 ... 35

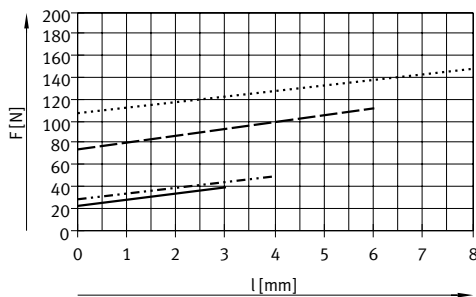

- HGPD-16-A-G
- · - · - · HGPD-20-A-G
- - - - - HGPD-25-A-G
- · · · · HGPD-32-A-G

#### HGPD-40 ... 80

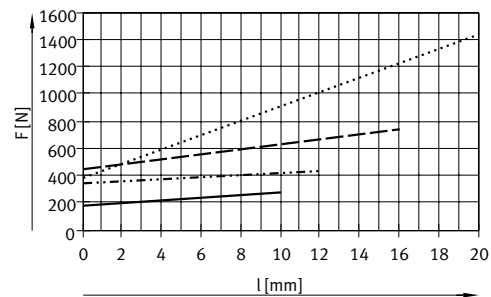

- HGPD-40-A-G
- · - · - · HGPD-50-A-G
- - - - - HGPD-63-A-G
- · · · · HGPD-80-A-G

### Spring force $F_F$ as a function of size, gripper jaw stroke $l$ and lever arm $x$ per gripper finger

The lever arm  $x$  must be taken into consideration when determining the actual spring force  $F_{\text{Total}}$ .

The formulae for calculating the spring force are provided in the table below.

Gripping force retention	Size	$F_{\text{Total}}$ per gripper finger
G1	16	$-0.25 \cdot x + 0.6 \cdot F_F$
	20	$-0.25 \cdot x + 0.6 \cdot F_F$
	25	$-0.65 \cdot x + 0.6 \cdot F_F$
	35	$-0.75 \cdot x + 0.8 \cdot F_F$
	40	$-0.7 \cdot x + 0.65 \cdot F_F$
	50	$-0.8 \cdot x + 0.5 \cdot F_F$
	63	$-0.8 \cdot x + 0.65 \cdot F_F$
80	$-1.3 \cdot x + 0.6 \cdot F_F$	

Gripping force retention	Size	$F_{\text{Total}}$ per gripper finger
G2	16	$-0.05 \cdot x + 0.6 \cdot F_F$
	20	$-0.5 \cdot x + 0.6 \cdot F_F$
	25	$-0.65 \cdot x + 0.6 \cdot F_F$
	35	$-0.15 \cdot x + 0.8 \cdot F_F$
	40	$-0.6 \cdot x + 0.65 \cdot F_F$
	50	$-0.15 \cdot x + 0.5 \cdot F_F$
	63	$-1 \cdot x + 0.65 \cdot F_F$
80	$-0.25 \cdot x + 0.6 \cdot F_F$	

### Determining the actual gripping forces $F_{\text{Gr}}$ per gripper finger for HGPD-...-G1 and HGPD-...-G2 as a function of application

The parallel grippers with integrated spring type HGPD-...-G1 (opening gripping force retention) and HGPD-...-G2 (closing gripping force retention) can be used as

- single-acting grippers
- grippers with supplementary gripping force and
- grippers with gripping force retention depending on requirements.

In order to calculate the available gripping forces  $F_{\text{Gr}}$  (per gripper jaw), the gripping force  $F_H$  and spring force  $F_{\text{Total}}$  must be combined accordingly.

#### Application forces per gripper finger

Single-acting	Supplementary gripping force	Gripping force retention
<ul style="list-style-type: none"> <li>• Gripping with spring force: <math>F_{\text{Gr}} = F_{\text{Total}}</math></li> <li>• Gripping with pressure force: <math>F_{\text{Gr}} = F_H - F_{\text{Total}}</math></li> </ul>	<ul style="list-style-type: none"> <li>• Gripping with pressure and spring force: <math>F_{\text{Gr}} = F_H + F_{\text{Total}}</math></li> </ul>	<ul style="list-style-type: none"> <li>• Gripping with spring force: <math>F_{\text{Gr}} = F_{\text{Total}}</math></li> </ul>

Data sheet

Dimensions

Download CAD data → [www.festo.com](http://www.festo.com)

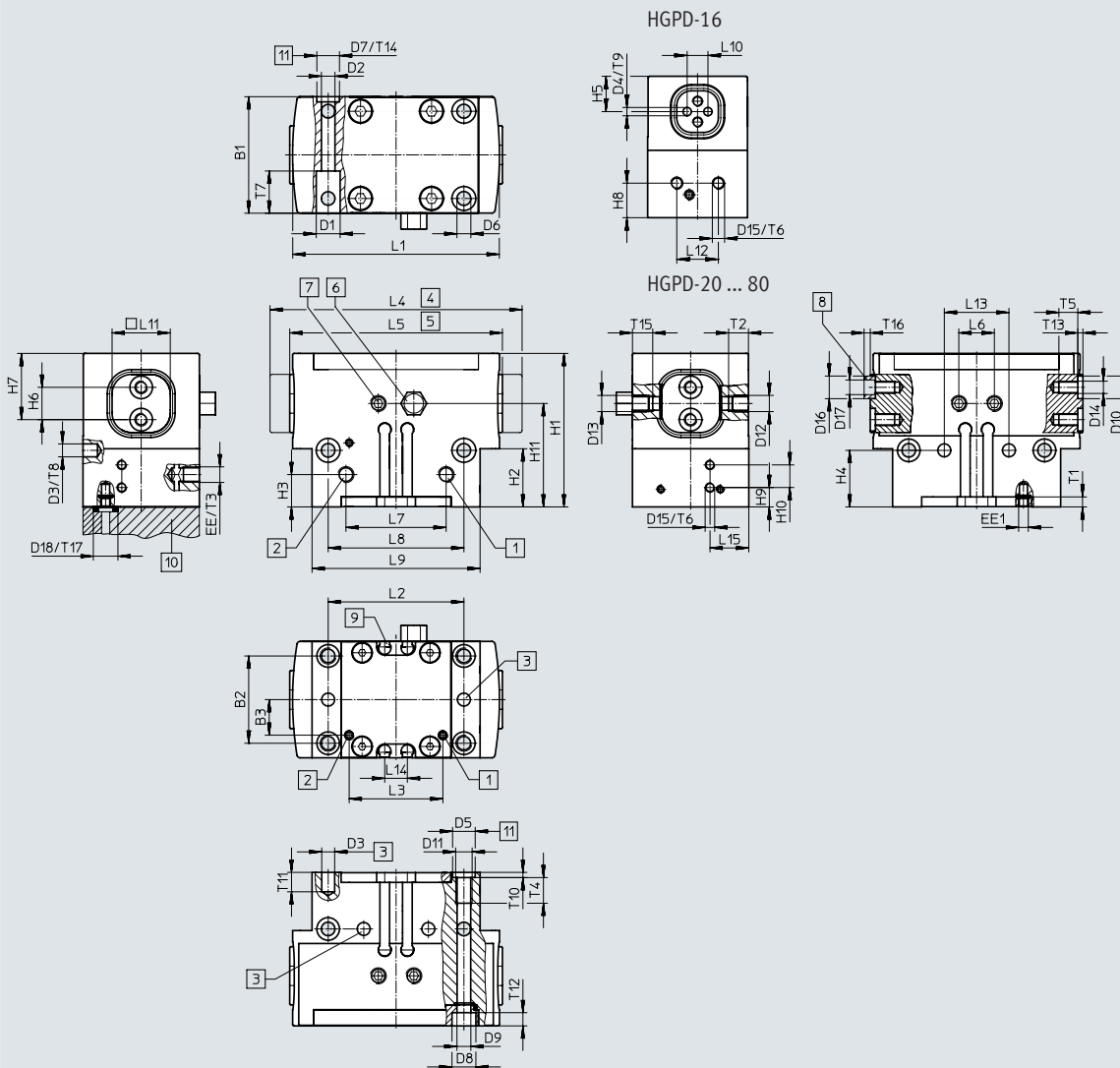

- [1] Supply port, opening, either on the side or underneath (bottom port sealed on delivery)
- [2] Supply port, closing, either on the side or underneath (bottom port sealed on delivery)
- [3] Drilled hole for dowel pin (not included in the scope of delivery)
- [4] Gripper jaws open
- [5] Gripper jaws closed
- [6] Exhaust hole
- [7] Lubrication nipple (sealed on delivery)
- [8] Centring sleeves ZBH (4 included in the scope of delivery)
- [9] Slot for proximity switch
- [10] O-ring for parallel gripper  
HGPD-20 ... 35:  $\varnothing$  3x1  
HGPD-40 ... 80:  $\varnothing$  5x1.5
- [11] Drilled hole for centring sleeve ZBH

Size	B1	B2 <sup>1)</sup>	B3	D1	D2	D3	D4	D5	D6	D7	D8	D9	D10	D11	D12
[mm]	±0.05		±0.1	$\varnothing$ H13	$\varnothing$	$\varnothing$ H8	$\varnothing$ H8	$\varnothing$ H8	$\varnothing$	$\varnothing$ H8	$\varnothing$ H13	$\varnothing$	$\varnothing$ H8		
16	24	17	4	4.6	2.6	2	2	5	2.6	–	4.6	–	–	M3	M3
20 <sup>2)</sup>	28	22	8.7	5.6	3.2	3	–	5	3.2	–	–	–	5	M4	M3
25	36	27	11	7.4	4.2	4	–	7	4.2	7	7.4	4.3	7	M5	M5
35	42	32	13	9.2	5.2	4	–	7	4.2	7	7.4	4.3	9	M5	M5
40	50	38	17	10.4	6.2	5	–	9	5.2	9	9.4	5.3	9	M6	M5
50	60	45	20	13.5	8.2	6	–	12	6.1	12	10.4	6.4	12	M8	M5
63	72	56	24.5	13.5	8.4	6	–	12	6.4	12	10.4	–	12	M8	M5
80	100	70	39.5	18.5	12.2	8	–	12	8.5	15	13.5	8.4	15	M10	M5

1) Tolerance for centring hole ±0.02 mm  
Tolerance for thread ±0.1 mm  
2) Dowel pins [3] must be used when mounted from below.

## Data sheet

Size [mm]	D13	D14	D15	D16 ∅ h7	D17 ∅	D18 ∅ +0.2	EE	EE1	H1		H2		H3	
									±0.05	-G ±0.05		-G	±0.1	-G ±0.1
16	M3	M2.5	M3	–	–	–	M5	M3	34	41.5	16.2	23.6	12	12
20	M3	M3	M3	5	3.2	5	M5	M3	39	46	15	22	10	15
25	M5	M4	M3	7	5.3	5	M5	M3	47.5	55.5	18	26	10	20
35	M5	M6	M3	9	6.4	5	M5	M3	57.5	74	21.5	38	12	23.5
40	M5	M6	M3	9	6.4	8	M5	M3	67	85	27	45	15	36
50	G1/8	M6	M3	12	10.3	8	G1/8	M5	77.5	102.5	32	57	15	30
63	G1/8	M8	M3	12	10.3	8	G1/8	M5	94	124	39	69	18	26
80	G1/8	M10	M3	15	12.4	8	G1/4	M5	110	146	48	84	22	33

Size [mm]	H4 <sup>1)</sup>		H5	H6 <sup>1)</sup>	H7	H8		H9		H10	H11		L1	L2 <sup>1)</sup>	L3
		-G	-0.02		-0.02	±0.1	-G ±0.1	±0.1	-G ±0.1	±0.1	±0.1	±0.1	±0.1	±0.05	
16	17.5	24.5	8.5	5	11	8.3	15.8	–	–	–	25.5	33	50	29	22
20	14.5	21.5	–	7	15	6.5	13.5	–	–	–	27.5	34.5	50	35	22.6
25	17.5	26	–	10	20.5	–	–	6	14	7	32	40	64	42	29
35	20	37.5	–	12	24	–	–	9.5	26	7	39.5	56	80	52	39
40	25	42.5	–	15	28.5	–	–	15	33	8	46	64	101	66	47.4
50	30	55	–	18	32	–	–	15.5	40.5	8	54.5	79.5	126	82	61
63	28	68	–	24	40	–	–	26	56	8	66	96	161	100	75
80	34	76	–	24	42	–	–	35	71	8	80	116	201	130	82

Size [mm]	L4	L5	L6	L7	L8 <sup>1)</sup>	L9	L10	L11	L12	L13	L14	L15	T1	T2	T3
	±0.5	±0.5	±0.1	±0.1		±0.1	±0.05	-0.02	±0.1	±0.02	+0.1	±0.1	min.	min.	min.
16	58	52	6.5	20	29	36	5	10	10	20	6	–	3	5.5	5.5
20	60	52	7.5	24	35	44	–	14	10	24	6	–	3	5.5	5.5
25	78	66	11	31	42	52	–	18	–	20	7	12	3	6.7	5.5
35	98	82	11	40	52	64	–	22	–	40	7	15	3	6.5	5.5
40	122	102	11	49	66	81	–	28	–	50	10	19	4	6.5	6.5
50	151	127	11	63	82	101	–	32	–	60	10	24	4	6.5	8.5
63	194	162	11	74	100	126	–	40	–	76	10	42	4	6.5	8.5
80	242	202	11	82	130	154	–	45	–	100	10	56	5.5	6.5	10

Size [mm]	T4		T5	T6	T7	T8	T9	T10	T11	T12	T13	T14	T15	T16	T17
	min.	-G min.	min.	min.		min.	+0.1	+0.1	min.	+0.2	+0.1	+0.1	min.	-0.3	+0.1
16	5.5	–	5	3.5	14	4.5	2.6	1.3	4	19.8	–	–	5.5	–	–
20	6.5	–	5	5	18	4	–	1.3	5	3	1.3	–	5.5	1.2	0.6
25	10.5	–	6	5	13	4.5	–	1.6	6	4.1	1.6	1.6	6.7	1.4	0.6
35	8.5	–	7.9	5	16	4.5	–	1.6	6	4.1	2.1	1.6	6.5	1.9	0.6
40	12.5	–	7.9	5	28	6	–	2.1	7	5.1	2.1	2.1	6.5	1.9	1.1
50	12.5	–	10	5	24	6	–	2.6	8	6.1	2.6	2.6	6.5	2.4	1.1
63	12.5	–	12	5	27	6	–	2.6	8	4.5	2.6	2.6	6.5	2.4	1.1
80	12.4	15	15	5	41	10	–	2.6	10	5.5	3.1	3.1	6.5	2.9	1.1

1) Tolerance for centring hole ±0.02 mm  
Tolerance for thread ±0.1 mm

## Data sheet

Ordering data						
Size [mm]	Double-acting Without compression spring		Single-acting or with gripping force retention			
	Part no.	Type	Opening Part no.	Type	Closing Part no.	Type
16	1132936	HGPD-16-A	1132937	HGPD-16-A-G1	1132938	HGPD-16-A-G2
20	1132939	HGPD-20-A	1132940	HGPD-20-A-G1	1132941	HGPD-20-A-G2
25	1132942	HGPD-25-A	1132943	HGPD-25-A-G1	1132944	HGPD-25-A-G2
35	1132945	HGPD-32-A	1132946	HGPD-32-A-G1	1132947	HGPD-32-A-G2
40	1132948	HGPD-40-A	1132949	HGPD-40-A-G1	1132950	HGPD-40-A-G2
50	1132951	HGPD-50-A	1132952	HGPD-50-A-G1	1132953	HGPD-50-A-G2
63	1132954	HGPD-63-A	1132955	HGPD-63-A-G1	1132956	HGPD-63-A-G2
80	1132957	HGPD-80-A	1132958	HGPD-80-A-G1	1132959	HGPD-80-A-G2



## Accessories



### Adapter kit DHAA

Material:  
Wrought aluminium alloy  
Free of copper and PTFE  
RoHS-compliant



**Note**

The kit includes the individual mounting interface as well as the necessary mounting material.

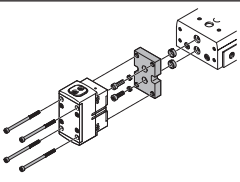
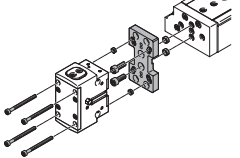
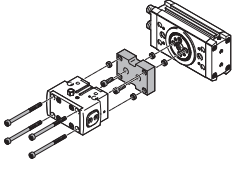
Permissible drive/gripper combinations with adapter kit							Download CAD data → <a href="http://www.festo.com">www.festo.com</a>	
Combination	Drive size	Gripper size	Mounting option		Adapter kit CRC <sup>1)</sup>	Part no.	Type	
								
<b>DGST/HGPD</b>	<b>DGST</b>	<b>HGPD</b>			<b>DHAA</b>			
	10	16	—	■	2	8163132	DHAA-G-G8-10-B12-16	
	12	20	—	■		8163129	DHAA-G-G8-12-B12-20	
	16	25	—	■		8163133	DHAA-G-G8-16-B12-25	
	20	35	—	■		8163131	DHAA-G-G8-20-B12-35	
	25	40	—	■		8163130	DHAA-G-G8-25-B12-40	
<b>DGSL/HGPD</b>	<b>DGSL</b>	<b>HGPD</b>			<b>DHAA, HAPG</b>			
	8, 10	16, 20	■	■	2	564957	DHAA-G-G6-8-B8-16	
	12, 16	16, 20	■	■		564954	DHAA-G-G6-16-B8-16	
	12, 16	25	■	■		564952	DHAA-G-G6-16-B8-25	
	20, 25	25, 35	■	■		537175	HAPG-79	
	20, 25	40	■	■		564951	DHAA-G-G6-20-B8-40	
<b>DRRD/HGPD</b>	<b>DRRD</b>	<b>HGPD</b>			<b>DHAA</b>			
	12	16	■	■	2	2449935	DHAA-G-Q11-12-B12-16	
	12	20	■	■		2449945	DHAA-G-Q11-12-B12-20	
	16	16	■	■		2091914	DHAA-G-Q11-16-B12/B12G-16	
	16	20	■	■		2091205	DHAA-G-Q11-16-B12-20	
	16	25	■	■		2090715	DHAA-G-Q11-16-B12-25	
	20	25	■	■		2088381	DHAA-G-Q11-20-B12-25	
	20	35	■	■		2088008	DHAA-G-Q11-20-B12-35	
	25	35	■	■		1714646	DHAA-G-Q11-25-B12-35	
	25	40	■	■		1715576	DHAA-G-Q11-25-B12-40	
	32	40	■	■		2092197	DHAA-G-Q11-32-B12-40	
	35	40	■	■		2114998	DHAA-G-Q11-35-B12-40	
	32	50	■	■		2124051	DHAA-G-Q11-32-B12-50	
	35, 40	50	■	■		2124346	DHAA-G-Q11-3 5/40-B12-50	
	40	63	■	■		2125614	DHAA-G-Q11-40-B12-63	
	50	63	■	■		2352692	DHAA-G-Q11-50-B12-63	
50	80	■	■	2412840	DHAA-G-Q11-50-B12-80			

1) Corrosion resistance class CRC 2 to Festo standard FN 940070

Moderate corrosion stress. Indoor applications in which condensation can occur. External visible parts with primarily decorative surface requirements which are in direct contact with a normal industrial environment.

## Accessories

**Adapter kit**  
DHAA, HAPG

Material:  
Wrought aluminium alloy  
Free of copper and PTFE  
RoHS-compliant





**Note**

The kit includes the individual mounting interface as well as the necessary mounting material.

**Permissible drive/gripper combinations with adapter kit**

Download CAD data → [www.festo.com](http://www.festo.com)

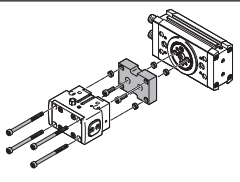
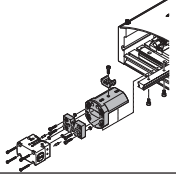
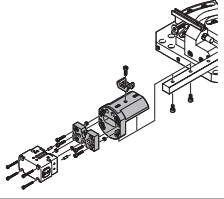
Combination	Drive size	Gripper size	Mounting option		Adapter kit CRC <sup>1)</sup>	Part no.	Type
							
<b>DRRD/HGPD</b>	<b>DRRD</b>	<b>HGPD-...-G1/G2</b>			<b>DHAA</b>		
	12	16	■	■	2	2798991	DHAA-G-Q11-12-B12G-16
	12	20	■	■		2800963	DHAA-G-Q11-12-B12G-20
	16	20	■	■		2642948	DHAA-G-Q11-16-B12G-20
	16	25	■	■		2642941	DHAA-G-Q11-16-B12G-25
	20	25	■	■		2642953	DHAA-G-Q11-20-B12G-25
	20	35	■	■		2642961	DHAA-G-Q11-20-B12G-35
	25	35	■	■		2642962	DHAA-G-Q11-25-B12G-35
	25	40	■	■		2642966	DHAA-G-Q11-25-B12G-40
	32	40	■	■		2642967	DHAA-G-Q11-32-B12G-40
	32	50	■	■		2642969	DHAA-G-Q11-32-B12G-50
	35	40	■	■		2643047	DHAA-G-Q11-35-B12G-40
	35, 40	50	■	■		2643100	DHAA-G-Q11-3 5/40-B12G-50
	40	63	■	■		2643055	DHAA-G-Q11-40-B12G-63
	50	63	■	■		2643096	DHAA-G-Q11-50-B12G-63
	50	80	■	■		2643098	DHAA-G-Q11-50-B12G-80
<b>HSP/HGPD</b>	<b>HSP</b>	<b>HGPD</b>			<b>DHAA, HAPG</b>		
	12	16	■	–	2	564957	DHAA-G-G6-8-B8-16
						540881	HAPG-70-B
	16	16, 20	■	–		564957	DHAA-G-G6-8-B8-16
						540882	HAPG-71-B
	25	16, 20	■	–	564957	DHAA-G-G6-8-B8-16	
					540883	HAPG-72-B	
<b>HSW/HGPD</b>	<b>HSW</b>	<b>HGPD</b>			<b>DHAA, HAPG</b>		
	12, 16	16	■	–	2	564957	DHAA-G-G6-8-B8-16
						540882	HAPG-71-B
	16	20	■	–		564957	DHAA-G-G6-8-B8-16
						540882	HAPG-71-B

1) Corrosion resistance class CRC 2 to Festo standard FN 940070

Moderate corrosion stress. Indoor applications in which condensation can occur. External visible parts with primarily decorative surface requirements which are in direct contact with a normal industrial environment.

## Accessories



### Adapter kit DHAA, HAPG

Material:  
Wrought aluminium alloy  
Free of copper and PTFE  
RoHS-compliant

 **Note**

The kit includes the individual mounting interface as well as the necessary mounting material.

Download CAD data → [www.festo.com](http://www.festo.com)

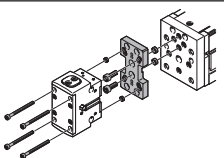
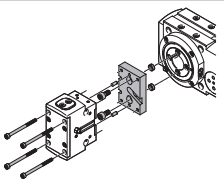
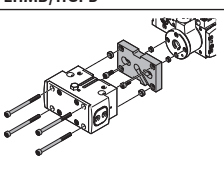
Combination	Drive size	Gripper size	Mounting option		Adapter kit CRC <sup>1)</sup>	Part no.	Type
							
<b>EGSL/HGPD</b>	<b>EGSL</b>	<b>HGPD</b>			<b>DHAA, HAPG</b>		
	45, 55	25	■	■	2	564952	DHAA-G-G6-16-B8-25
	75	25, 35	■	■		537175	HAPG-79
	75	40	■	■		564951	DHAA-G-G6-20-B8-40
<b>ERMB/HGPD</b>	<b>ERMB</b>	<b>HGPD</b>			<b>DHAA, HAPG</b>		
	20	25	■	■	2	537181	HAPG-SD2-25
	20, 25	35	■	■		537173	HAPG-SD2-23
	25, 32	40	■	■		537184	HAPG-SD2-26
	32	50	■	■		564956	DHAA-G-Q5-32-B8-50
<b>EHMB/HGPD</b>	<b>EHMB</b>	<b>HGPD</b>			<b>DHAA, HAPG</b>		
	20	40	■	■	2	537184	HAPG-SD2-26
	20, 25, 32	50	■	■		564956	DHAA-G-Q5-32-B8-50
	25, 32	63	■	■		537188	HAPG-SD2-28

1) Corrosion resistance class CRC 2 to Festo standard FN 940070

Moderate corrosion stress. Indoor applications in which condensation can occur. External visible parts with primarily decorative surface requirements which are in direct contact with a normal industrial environment.

## Accessories

### Gripper jaw blank BUB-HGPD

(2 included in the scope of delivery)

Material:

Wrought aluminium alloy

Free of copper and PTFE

RoHS-compliant

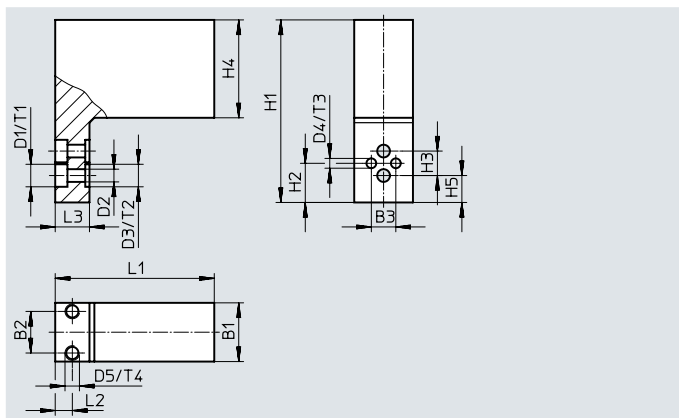
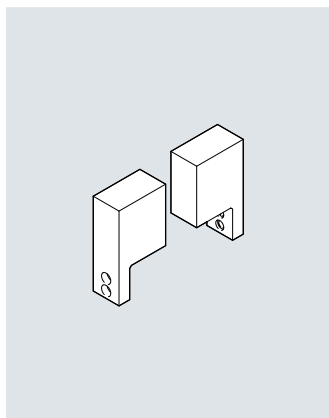

#### Dimensions and ordering data

For size	B1	B2	B3	D1	D2	D3	D4	D5
[mm]	±0.05		±0.01	∅ H13	∅ H13	∅ H8	∅ H7	
16	12	8.5	5	4.6	2.6	–	2	M3
20	14	8.5	–	5.9	3.2	5	–	M3
25	20	14	–	7.4	4.3	7	–	M3
35	29	23	–	10.4	6.4	9	–	M3
40	32	26	–	10.4	6.4	9	–	M3
50	35	26	–	10.4	6.4	12	–	M3
63	40	26	–	13.5	8.4	12	–	M3
80	44	26	–	16.5	10.5	15	–	M3

For size	H1	H2	H3	H4	H5	L1	L2	L3
[mm]	±0.05	±0.02				±0.05		
16	37.3	8	5±0.1	20	–	32.5	3.5	7
20	59	–	7±0.01 <sup>1)</sup>	35	8	35.5	3	10
25	76	–	10±0.01 <sup>1)</sup>	49.5	4.5	44.5	4.5	12
35	92.5	–	12±0.01 <sup>1)</sup>	59	7.5	52.5	6	12
40	110	–	15±0.01 <sup>1)</sup>	73.5	6	62.5	6	12
50	144	–	18±0.01 <sup>1)</sup>	99	11	78	10	15
63	171.5	–	24±0.01 <sup>1)</sup>	119	10	98.5	10.5	15
80	198	–	24±0.01 <sup>1)</sup>	139	15	120.5	10	20

For size	T1	T2	T3	T4	Weight per blank [g]	Part no.	Type
[mm]	+0.1	+0.1	+0.1				
16	2.5	–	2.1	4	25	<b>1180947</b>	<b>BUB-HGPD-16</b>
20	3.1	1.3	–	5	57	<b>1180948</b>	<b>BUB-HGPD-20</b>
25	4.2	1.6	–	5	138	<b>1180949</b>	<b>BUB-HGPD-25</b>
35	6.2	2.1	–	5	278	<b>1180950</b>	<b>BUB-HGPD-35</b>
40	6.2	2.1	–	5	445	<b>1180951</b>	<b>BUB-HGPD-40</b>
50	6.2	2.6	–	5	814	<b>1180952</b>	<b>BUB-HGPD-50</b>
63	8.2	2.6	–	5	1340	<b>1180953</b>	<b>BUB-HGPD-63</b>
80	10.2	3.1	–	5	2170	<b>1180954</b>	<b>BUB-HGPD-80</b>

1) ±0.02 and ±0.01 apply to the centring hole D3

±0.1 applies to the through-holes D1 and D2

## Accessories

### Sensor bracket DASI

(1 included in the scope of delivery)

Material:

Wrought aluminium alloy

RoHS-compliant

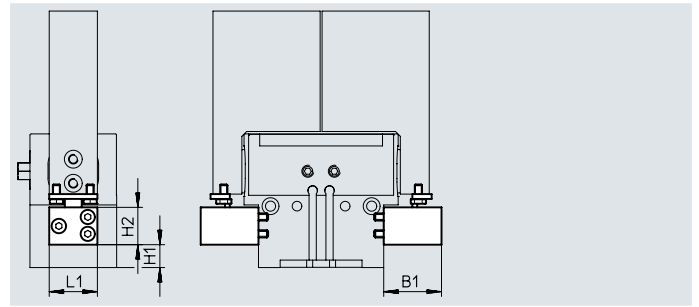
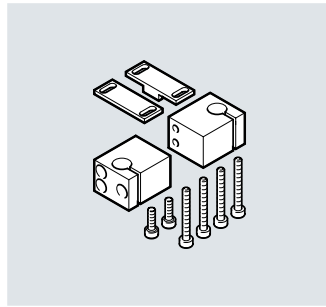

Dimensions and ordering data								
For size	B1	H1		H2	L1	Weight	Part no.	Type
[mm]			-G			[g]		
16	18	4.3	11.8	8	18	25	1435225	DASI-B12-16-S3
20	18	2.5	9.5	8	18	22	1435226	DASI-B12-20-S3
25	24	1.5	9.5	15.5	20	50	1435227	DASI-B12-25-S8
35	24	5	21.5	15.5	20	55	1435228	DASI-B12-35-S8
40	29	11.2	29.2	15.6	20	65	1435229	DASI-B12-40-S8
50	34	12	37	16	20	70	1435230	DASI-B12-50-S8
63	54	22	52	16	20	95	1435231	DASI-B12-63-S8
80	54	31	67	16	20	95	1435231	DASI-B12-63-S8

Ordering data						
	For size [mm]	Description	Weight [g]	Part no.	Type	PU <sup>1)</sup>
Centring pin/sleeve ZBS/ZBH <span style="float: right;">Data sheets → Internet: zbh</span>						
	16	For centring the gripper jaw blanks/gripper fingers on the gripper jaws	1	525273	ZBS-2	10
	20		1	8146543	ZBH-5-B	
	25		1	8146544	ZBH-7-B	
	35, 40		1	8137184	ZBH-9-B	
	50, 63		1	8137185	ZBH-12-B	
	80		3	191409	ZBH-15	
	16, 20	For centring the gripper during mounting	1	8146543	ZBH-5-B	
	25, 35		1	8146544	ZBH-7-B	
	40		1	8137184	ZBH-9-B	
	50, 63, 80		1	8137185	ZBH-12-B	
Blanking plug B <span style="float: right;">Data sheets → Internet: blanking plug</span>						
	16, 20	For sealing the supply ports	1	30979	B-M3-S9	10
	25, 35, 40		1	174308	B-M5-B	
	50, 63		5	3568	B-1/8	
	80		15	3569	B-1/4	

1) Packaging unit

## Accessories

### Proximity switch for size 16 ... 35

#### Ordering data – Proximity switch for C-slot, magneto-resistive

Data sheets → Internet: smt

	Type of mounting	Electrical connection, outlet direction of connection	Switching output	Cable length [m]	Part no.	Type
<b>N/O contact</b>						
	Insertable in the slot lengthwise	Cable, 3-wire, lateral	PNP	2.5	547862	SMT-10G-PS-24V-E-2.5Q-OE
		Plug M8x1, 3-pin, lateral		0.3	547863	SMT-10G-PS-24V-E-0.3Q-M8D
		Cable, 3-wire, lateral	NPN	2.5	8065030	SMT-10G-NS-24V-E-2.5Q-OE
		Plug M8x1, 3-pin, lateral		0.3	8065029	SMT-10G-NS-24V-E-0.3Q-M8D

### Proximity switch for size 40 ... 80



#### Ordering data – Proximity switch for T-slot, magneto-resistive

Data sheets → Internet: smt

	Type of mounting	Electrical connection, outlet direction of connection	Switching output	Cable length [m]	Part no.	Type
<b>N/O contact</b>						
	Insertable in the slot lengthwise	Cable, 3-wire, lateral	PNP	2.5	547859	SMT-8G-PS-24V-E-2.5Q-OE
		Plug M8x1, 3-pin, lateral		0.3	547860	SMT-8G-PS-24V-E-0.3Q-M8D
		Cable, 3-wire, lateral	NPN	2.5	8065028	SMT-8G-NS-24V-E-2.5Q-OE
		Plug M8x1, 3-pin, lateral		0.3	8065027	SMT-8G-NS-24V-E-0.3Q-M8D

### Ordering data – Connecting cables

Data sheets → Internet: nebu

	Electrical connection, left	Electrical connection, right	Cable length [m]	Part no.	Type
	Straight socket, M8x1, 3-pin	Cable, open end, 3-wire	2.5	541333	NEBU-M8G3-K-2.5-LE3
			5	541334	NEBU-M8G3-K-5-LE3
	Angled socket, M8x1, 3-pin	Cable, open end, 3-wire	2.5	541338	NEBU-M8W3-K-2.5-LE3
			5	541341	NEBU-M8W3-K-5-LE3

### Proximity switch for size 16, 20

#### Ordering data – Proximity switch 3 mm (round design), inductive

Data sheets → Internet: sieh

	Electrical connection	LED	Switching output	Cable length [m]	Part no.	Type
<b>N/O contact</b>						
	Cable, 3-wire	■	PNP	2.5	538264	SIEH-3B-PS-K-L
	Plug M8x1, 3-pin	■	PNP	–	538263	SIEH-3B-PS-S-L

### Proximity switch for size 25 ... 80



#### Ordering data – Proximity switch M8 (round design), inductive

Data sheets → Internet: sien

	Electrical connection	LED	Switching output	Cable length [m]	Part no.	Type
<b>N/O contact</b>						
	Cable, 3-wire	■	PNP	2.5	150386	SIEN-M8B-PS-K-L
	Plug M8x1, 3-pin	■	PNP	–	150387	SIEN-M8B-PS-S-L

### Ordering data – Connecting cables

Data sheets → Internet: nebu

	Electrical connection, left	Electrical connection, right	Cable length [m]	Part no.	Type
	Straight socket, M8x1, 3-pin	Cable, open end, 3-wire	2.5	541333	NEBU-M8G3-K-2.5-LE3
			5	541334	NEBU-M8G3-K-5-LE3
	Angled socket, M8x1, 3-pin	Cable, open end, 3-wire	2.5	541338	NEBU-M8W3-K-2.5-LE3
			5	541341	NEBU-M8W3-K-5-LE3

# Festo - Your Partner in Automation



**1 Festo Inc.**  
 5300 Explorer Drive  
 Mississauga, ON L4W 5G4  
 Canada

**Festo Customer Interaction Center**  
 Tel: 1 877 463 3786  
 Fax: 1 877 393 3786  
 Email: customer.service.ca@festo.com



**2 Festo Pneumatic**  
 Av. Ceylán 3,  
 Col. Tequesquináhuac  
 54020 Tlalnepantla,  
 Estado de México

**Multinational Contact Center**  
 01 800 337 8669  
 ventas.mexico@festo.com



**3 Festo Corporation**  
 1377 Motor Parkway  
 Suite 310  
 Islandia, NY 11749

**Festo Customer Interaction Center**  
 1 800 993 3786  
 1 800 963 3786  
 customer.service.us@festo.com



**4 Regional Service Center**  
 7777 Columbia Road  
 Mason, OH 45040

Connect with us



[www.festo.com/socialmedia](http://www.festo.com/socialmedia)



[www.festo.com](http://www.festo.com)

Subject to change