

Three-point grippers HGDT, heavy-duty

FESTO

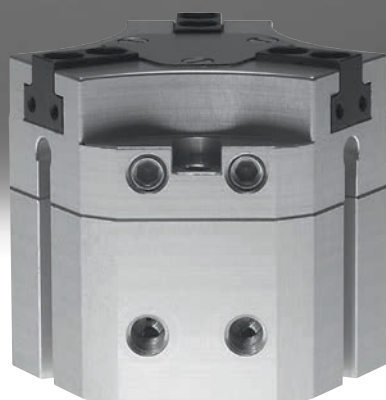

Key features

At a glance

The force generated by the linear motion is translated into the gripper jaw movement via a force-guided triple wedge mechanism. This also guarantees synchronous movement of the gripper jaws. The virtually backlash-free plain-bearing guide is realised using ground-in gripper jaws.

A wide range of uses:

- Double-acting gripper
- Compression spring for supplementing or backing up gripping forces, or for use as a single-acting gripper with only one compressed air supply port
- Suitable for external and internal gripping

Sealing air connection:

Compressed air flows past the gripper jaws when sealing air (max. 0.5 bar) is connected.

This prevents, for example, dust particles from entering the gripper jaw guide.

There are two variants available:

Standard – HGDT...
 Stroke per gripper jaw: 3 ... 10 mm
 Total gripping force: 207 ... 1728 N
 High force – HGDT-...-F
 Stroke per gripper jaw: 1.5 ... 5 mm
 Total gripping force: 411 ... 3372 N

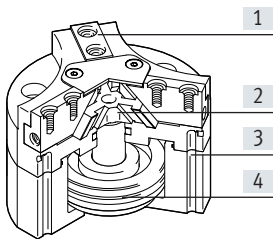

- [1] Gripper jaw
- [2] Triple wedge mechanism
- [3] Slot for proximity sensor
- [4] Piston with magnet

Note

Engineering software for gripper selection
 → www.festo.com

Wide range of compressed air supply ports

Directly from the front

Via adapter plate from underneath

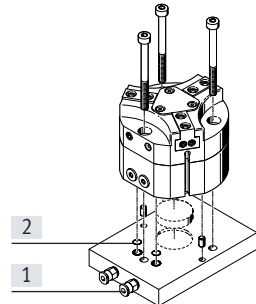
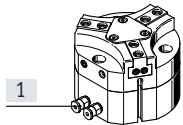

- [1] Compressed air supply ports
- [2] O-rings

Mounting options

Direct mounting from above

Via adapter plate from underneath

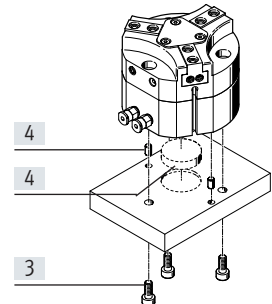
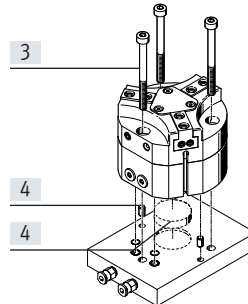

- [3] Retaining screws
- [4] Centring pins or centring disc

Note

These grippers are not suitable or are of limited suitability for the following application examples:

Not suitable for:

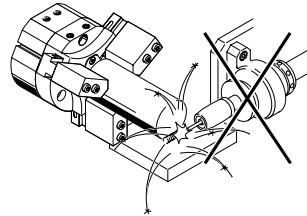

- Welding spatter

Of limited suitability for:

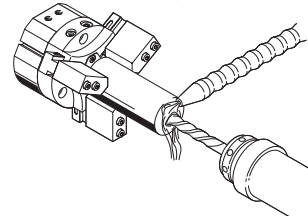

- Machining possible with sealing air
- Aggressive media only possible after consultation with Festo

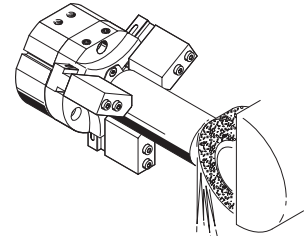

Peripherals overview and type codes

Peripherals overview

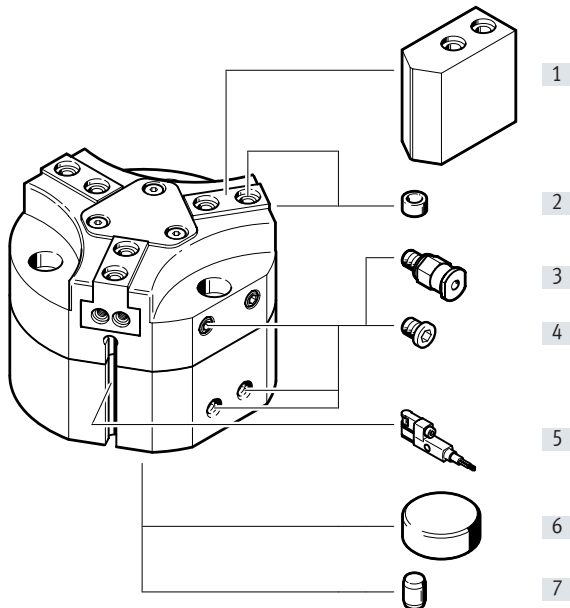

System product for handling and assembly technology

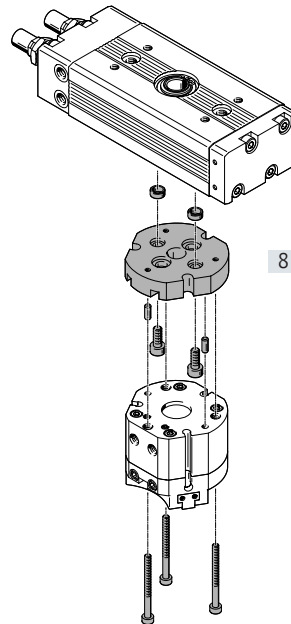

Accessories			
Type	Description	→ Page/Internet	
[1] Gripper jaw blank BUB-HGDT	Blanks specially matched to the gripper jaws for custom manufacturing of gripper fingers	16	
[2] Centring sleeve ZBH	For centring the gripper jaw blanks/gripper fingers on the gripper jaws	17	
[3] Push-in fitting QS	For connecting compressed air tubing with standard O.D.	qs	
[4] Blanking plug B	For sealing the compressed air supply ports when using the compressed air supply ports at the front	17	
[5] Proximity sensor SMT-10	For sensing the piston position, 3 slots available	17	
Proximity sensor SMT-10G	For sensing the piston position, 3 slots available	17	
[6] Central mounting SLZZ	For centring the gripper during mounting	17	
[7] Dowel pin	For centring the gripper during mounting	–	
[8] Adapter kit DHAA, HAPG	Drive/gripper connections	15	

Type codes

001	Series		
HGDT	Three-point gripper, sturdy		

002	Size		
25	25		
35	35		
40	40		
50	50		
63	63		

003	Position sensing		
A	For proximity sensor		

004	Gripping force		
	Standard		
F	High		

005	Gripping force backup		
	None		
G1	Opening		
G2	N/O contact		

Three-point grippers HGDT, heavy-duty

Data sheet

Double-acting
HGDT...-A

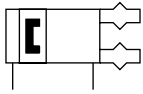



With gripping force backup
HGDT...-G1 (opening)



HGDT...-G2 (closing)



 Size
25 ... 63
 Stroke
1.5 ... 10 mm

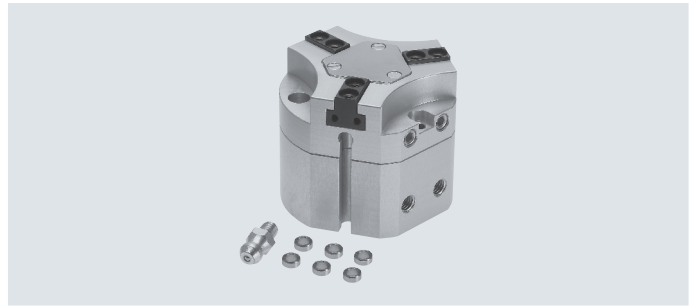

General technical data		25	35	40	50	63
Size		25	35	40	50	63
Design		Wedge-shaped actuator Force-guided motion sequence				
Mode of operation		Double-acting				
Gripper function		3-point				
Number of gripper jaws		3				
Max. load per gripper finger ¹⁾	[g]	10	30	70	160	250
Stroke per gripper jaw						
HGDT...-A	[mm]	3	4	6	8	10
HGDT...-A-F	[mm]	1.5	2	3	4	5
Pneumatic connection		M5	M5	M5	G1/8	G1/8
Pneumatic connection for sealing air		M5				
Repetition accuracy ²⁾	[mm]	≤ 0.03				
Max. operating frequency	[Hz]	≤ 4				
Position sensing		Via proximity sensor				
Type of mounting		Via through-hole, dowel pin or centring disc Via female thread, dowel pin or centring disc				
Mounting position		Optional				

1) Applies to unthrottled operation

2) Concentric to the central axis

Operating and environmental conditions

Min. operating pressure		
HGDT...	[bar]	3
HGDT...-G...	[bar]	4
Max. operating pressure	[bar]	8
Operating pressure for sealing air	[bar]	0 ... 0.5
Operating medium		Compressed air to ISO 8573-1:2010 [7:4:4]
Note on the operating/pilot medium		Lubricated operation possible (in which case lubricated operation will always be required)
Ambient temperature ¹⁾	[°C]	+5 ... +60
Corrosion resistance class CRC ²⁾		2

1) Note operating range of proximity sensors

2) Corrosion resistance class CRC 2 to Festo standard FN 940070

Moderate corrosion stress. Indoor applications in which condensation can occur. External visible parts with primarily decorative surface requirements which are in direct contact with a normal industrial environment.

Data sheet

Weight [g]					
Size	25	35	40	50	63
HGDT...	185	307	712	1104	1873
HGDT...-G1	203	337	840	1592	2469
HGDT...-G2	203	385	837	1440	2543

Materials

Sectional view

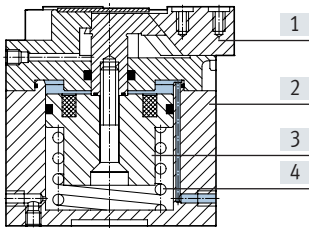

Three-point gripper	
[1] Gripper jaw	Hardened steel
[2] Housing	Smooth anodised aluminium
[3] Piston	Anodised aluminium
[4] Spring	Spring steel
- Seals	Nitrile rubber
- Note on materials	Free of copper and PTFE RoHS-compliant

Characteristic load values at the gripper jaws

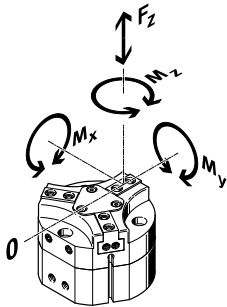

The indicated permissible forces and torques apply to a single gripper jaw. They include the lever arm, additional weight forces created by the workpiece or external gripper fingers and acceleration forces occurring during movement. The zero coordinate line (gripper jaws point of rotation) must be taken into consideration for the calculation of torques.

Size		25	35	40	50	63
Max. permissible force F_z	[N]	350	400	800	1500	2500
Max. permissible torque M_x	[Nm]	7	15	30	50	80
Max. permissible torque M_y	[Nm]	10	10	20	30	50
Max. permissible torque M_z	[Nm]	5	10	25	40	60

Mass moments of inertia [kgcm²]

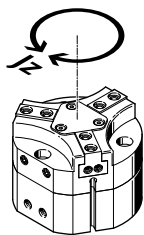

Mass moment of inertia of the three-point gripper in relation to the central axis, without external gripper fingers, without load.

Size		25	35	40	50	63
HGDT...		0.48	1.17	4.37	11.05	28.77
HGDT...-G1		0.5	1.37	5.59	15.33	42.44
HGDT...-G2		0.5	1.37	5.23	13.92	39.50

Data sheet

Opening and closing times [ms] at 6 bar

Without external gripper fingers

With external gripper fingers

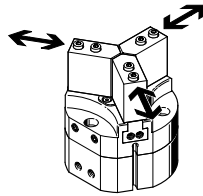
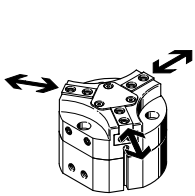

The opening and closing times [ms] were measured at room temperature at an operating pressure of 6 bar with a gripper horizontally mounted without additional gripper fingers. The grippers must be throttled for larger loads [g]. Opening and closing times must then be adjusted accordingly.

Size		25	35	40	50	63	
Without external gripper fingers							
Standard	HGDT...-A	Opening	28	40	62	85	152
		Closing	25	45	59	75	142
	HGDT...-A-G1	Opening	27	32	58	32	48
		Closing	33	56	160	146	246
	HGDT...-A-G2	Opening	33	46	111	61	159
		Closing	25	35	87	70	107
High force	HGDT...-A-F	Opening	20	43	48	96	163
		Closing	30	39	49	83	162
	HGDT...-A-F-G1	Opening	25	29	63	31	70
		Closing	61	67	190	170	299
	HGDT...-A-F-G2	Opening	38	53	117	88	169
		Closing	33	36	104	65	128
With external gripper fingers (as a function of the load per gripper finger)							
HGDT...	20 g	80	-	-	-	-	
	30 g	100	130	-	-	-	
	70 g	150	200	115	-	-	
	100 g	180	240	140	-	-	
	150 g	220	290	170	-	-	
	200 g	-	335	200	190	-	
	250 g	-	-	220	210	190	
	300 g	-	-	-	230	200	
	400 g	-	-	-	270	230	
	500 g	-	-	-	-	260	

Gripping force [N] at 6 bar

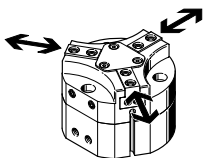

Size		25	35	40	50	63	
Gripping force per gripper jaw							
Standard	HGDT...-A	Opening	82	164	229	347	576
		Closing	69	152	206	307	551
High force	HGDT...-A-F	Opening	180	294	367	740	1124
		Closing	148	274	330	625	864
Total gripping force							
Standard	HGDT...-A	Opening	246	492	687	1041	1728
		Closing	207	456	618	921	1653
High force	HGDT...-A-F	Opening	540	882	1101	2220	3372
		Closing	444	822	990	1875	2592
Total gripping force with spring support (gripping force backup)							
Standard	HGDT...-A	Opening	286	555	814	1159	2186
		Closing	228	547	712	1052	2172
High force	HGDT...-A-F	Opening	708	1254	1629	2800	4456
		Closing	612	1194	1518	2655	4338

Data sheet

Standard – HGDT-...

Gripping force F_H per gripper jaw as a function of operating pressure and lever arm x

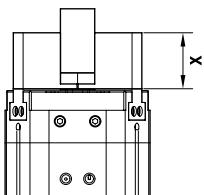

The gripping forces as a function of the operating pressure and lever arm can be determined from the following graphs.

External gripping (closing)

HGDT-25-A

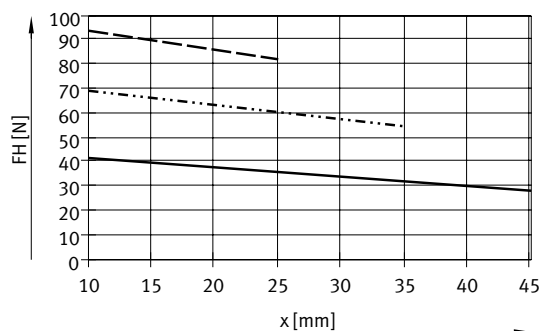

HGDT-35-A

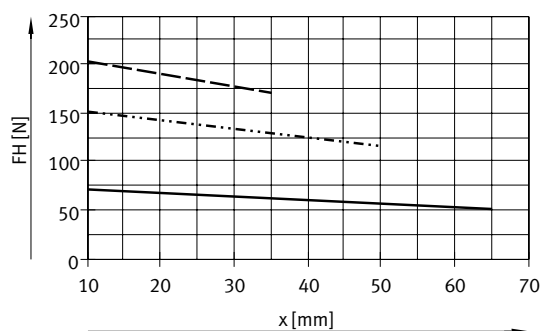

HGDT-40-A

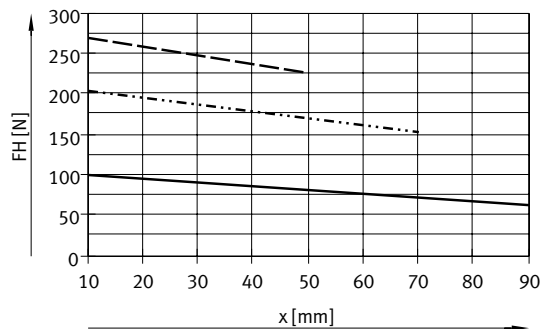

HGDT-50-A

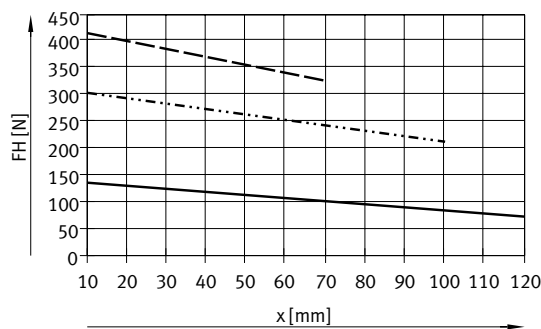

HGDT-63-A

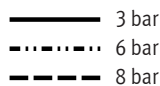
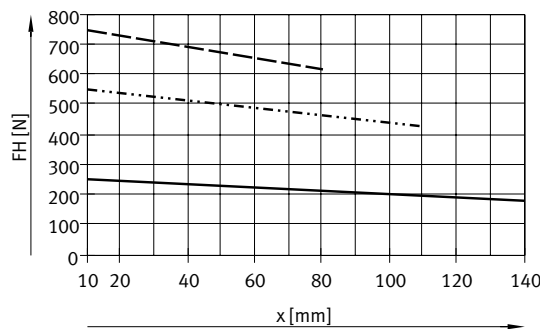

Data sheet

Standard – HGDT...

Gripping force F_H per gripper jaw as a function of operating pressure and lever arm x

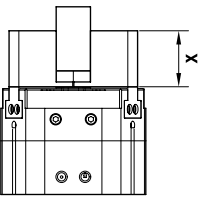

The gripping forces as a function of the operating pressure and lever arm can be determined from the following graphs.

Internal gripping (opening)

HGDT-25-A

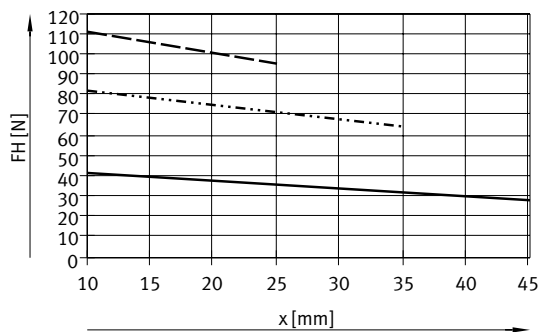

HGDT-35-A

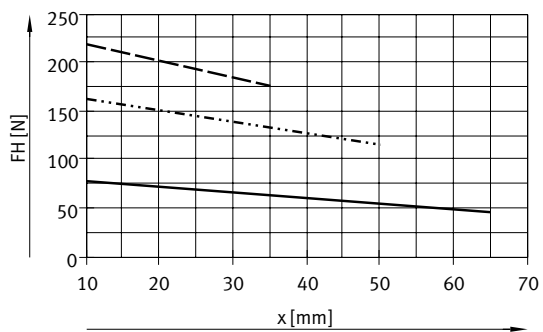

HGDT-40-A

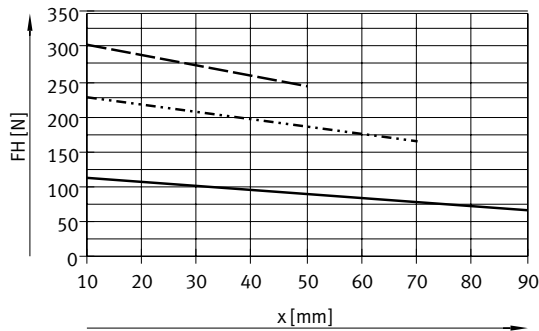

HGDT-50-A

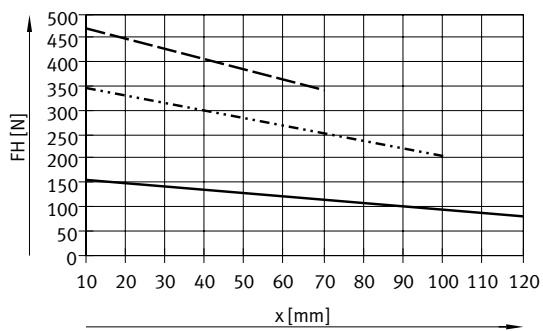

HGDT-63-A

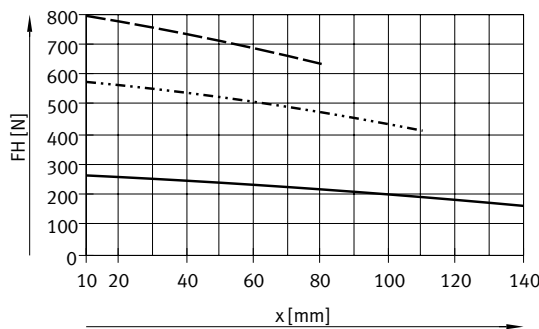

- 3 bar
- 6 bar
- 8 bar

Data sheet

High force – HGDT...-F

Gripping force F_H per gripper jaw as a function of operating pressure and lever arm x

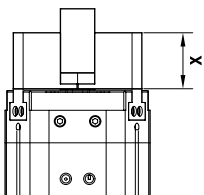

The gripping forces as a function of the operating pressure and lever arm can be determined from the following graphs.

External gripping (closing)

HGDT-25-A-F

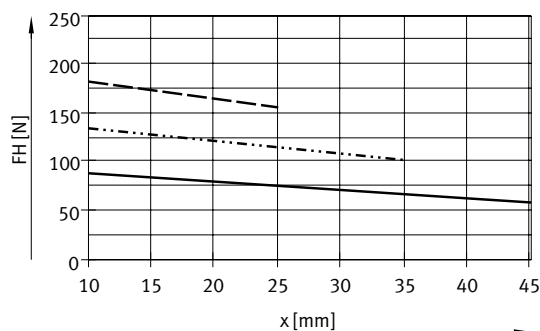

HGDT-35-A-F

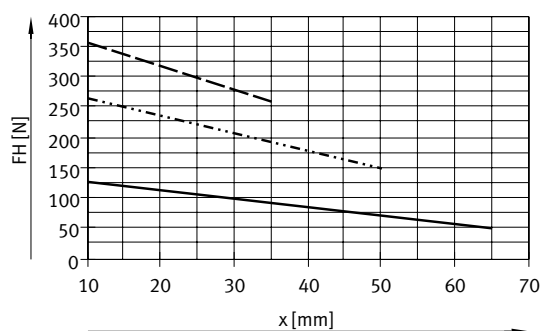

HGDT-40-A-F

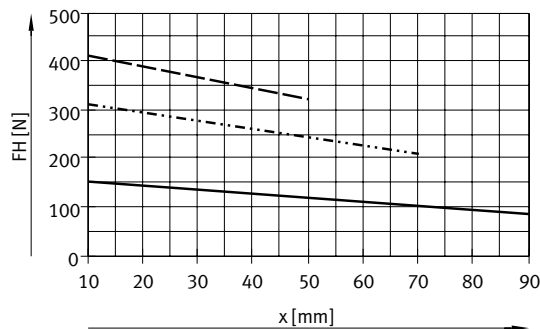

HGDT-50-A-F

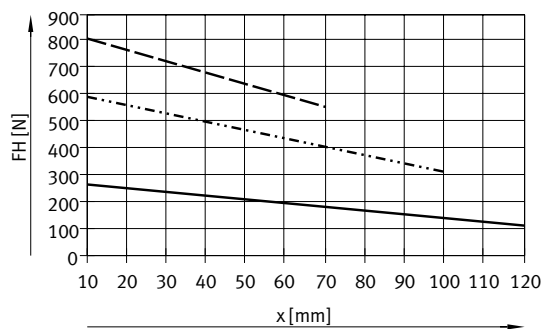

HGDT-63-A-F

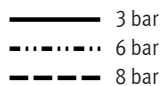
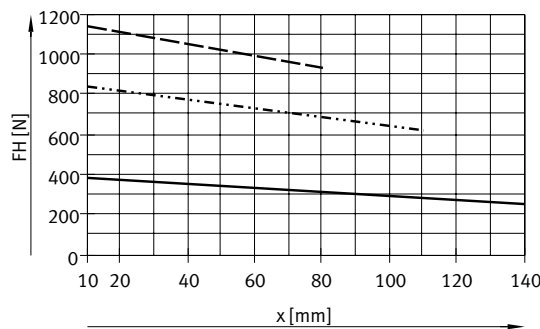

Data sheet

High force – HGDT...-F

Gripping force F_H per gripper jaw as a function of operating pressure and lever arm x

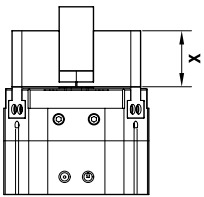

The gripping forces as a function of the operating pressure and lever arm can be determined from the following graphs.

Internal gripping (opening)

HGDT-25-A-F

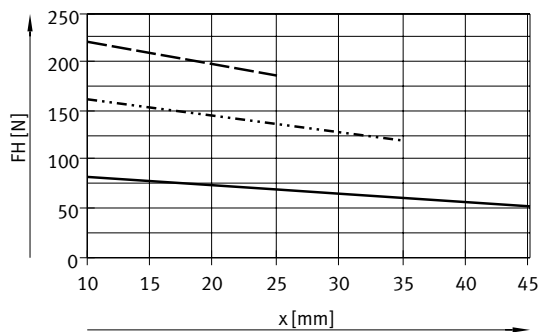

HGDT-35-A-F

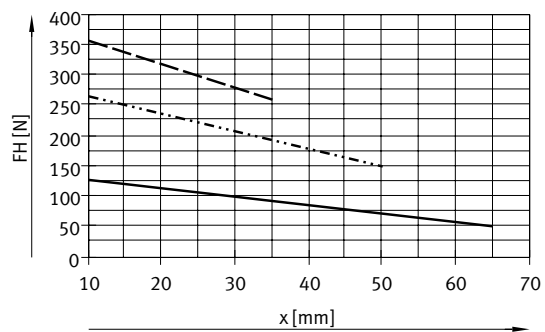

HGDT-40-A-F

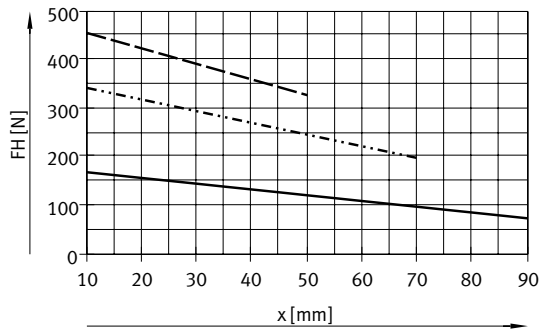

HGDT-50-A-F

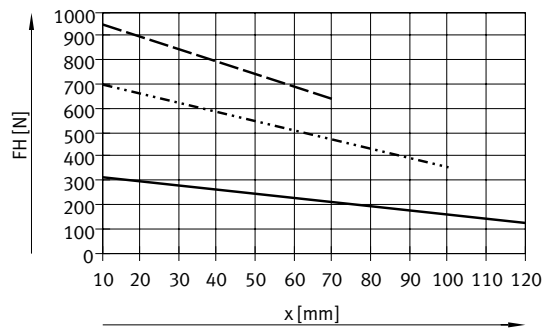

HGDT-63-A-F

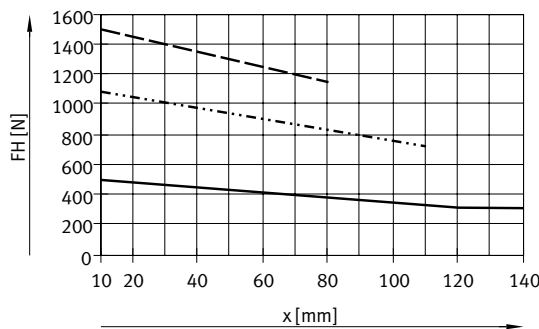

- 3 bar
- 6 bar
- - - 8 bar

Data sheet

Spring force F_S as a function of size, gripper jaw stroke l and lever arm x per gripper finger

Gripping force backup for HGDT...-G...

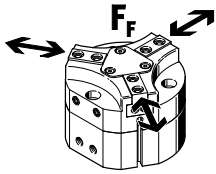

The spring forces F_S as a function of the gripper jaw stroke can be determined from the following graph.

Standard – HGDT...

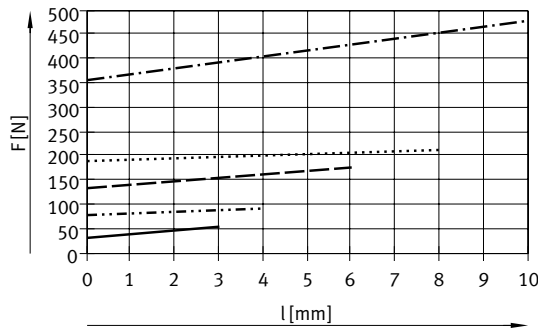

- HGDT-25-A-G...
- · - · - · HGDT-35-A-G...
- - - - - HGDT-40-A-G...
- · · · · HGDT-50-A-G...
- · - · - · HGDT-63-A-G...

High force – HGDT...

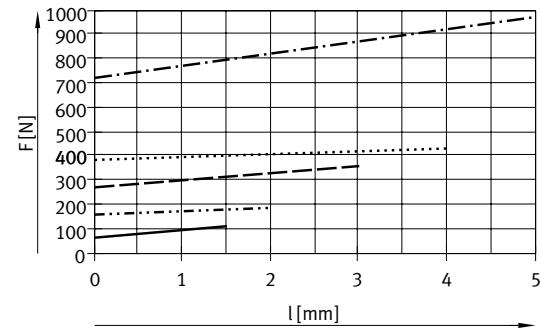

- HGDT-25-A-F-G...
- · - · - · HGDT-35-A-F-G...
- - - - - HGDT-40-A-F-G...
- · · · · HGDT-50-A-F-G...
- · - · - · HGDT-63-A-F-G...

The lever arm x [mm] must be taken into consideration when determining the actual spring force F_{Stotal} .
The formulae for calculating the spring force are provided in the following table.

Size	F_{Stotal} , per gripper finger	
	Standard – HGDT...	High force – HGDT...-F
25	$-0.3 * x + 0.85 * F_S$	$-2.24 * x + 0.64 * F_S$
35	$-0.5 * x + 0.75 * F_S$	$-0.97 * x + 0.7 * F_S$
40	$-0.5 * x + 0.8 * F_S$	$-1.45 * x + 0.66 * F_S$
50	$-0.6 * x + 0.7 * F_S$	$-0.97 * x + 0.51 * F_S$
63	$-0.6 * x + 0.75 * F_S$	$-2.35 * x + 0.72 * F_S$

Determining the actual gripping forces F_{Gr} for HGDT...-A-G1 and HGDT...-A-G2 as a function of the application, per gripper finger

Depending on the application, the three-point grippers with integrated spring type HGDT...-G1 (opening gripping force backup) and HGDT...-G2 (closing gripping force backup) can be used as:

- Single-acting grippers
- Grippers with supplementary gripping force
- Grippers with gripping force backup

In order to calculate the available gripping forces F_{Gr} (per gripper finger), the gripping force F_H and spring force F_{Stotal} must be combined accordingly.

Application forces per gripper finger

Single-acting

- Gripping with spring force:
 $F_{Gr} = F_{Stotal}$
- Gripping with pressure force:
 $F_{Gr} = F_H - F_{Stotal}$

Supplementary gripping force

- Gripping with pressure and spring force:
 $F_{Gr} = F_H + F_{Stotal}$

Gripping force backup

- Gripping with spring force:
 $F_{Gr} = F_{Stotal}$

Data sheet

Dimensions

Download CAD data → www.festo.com

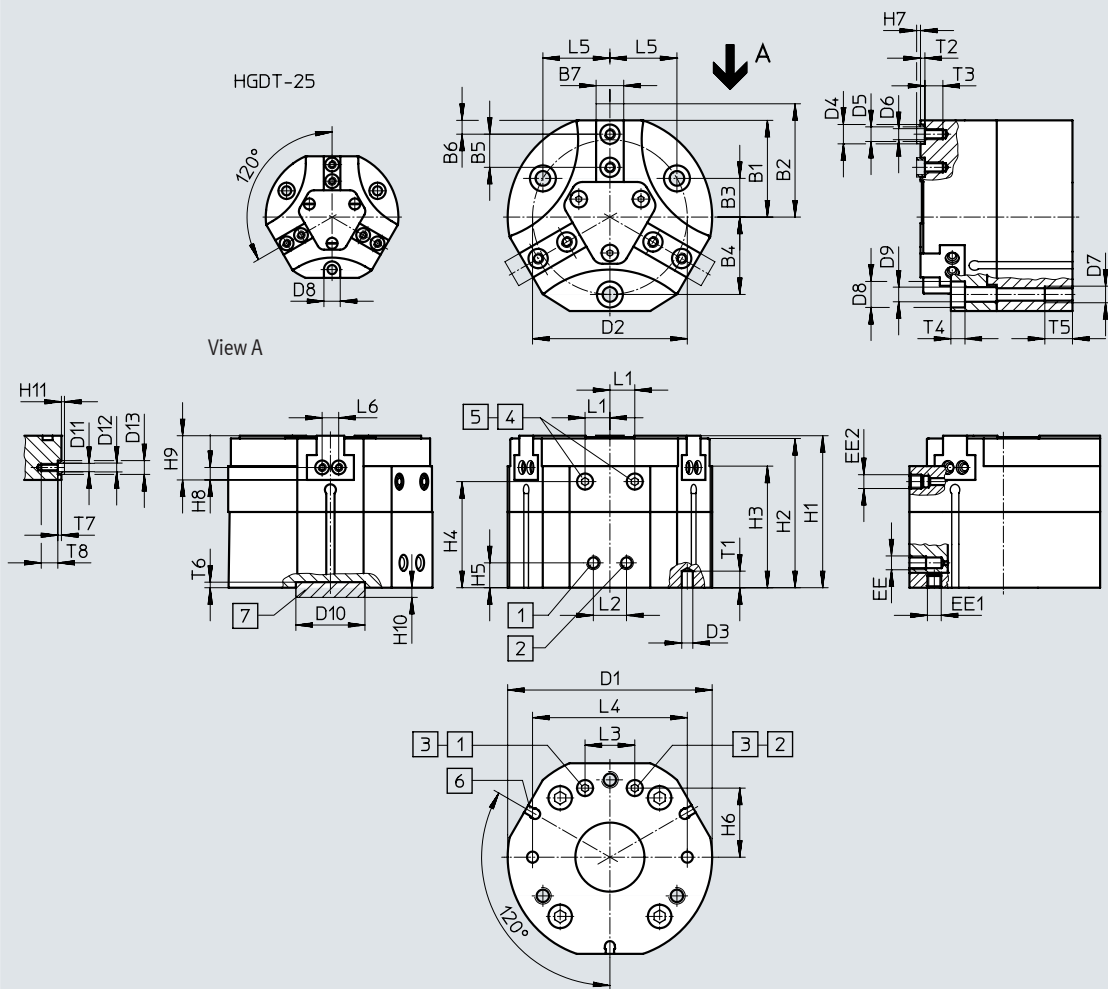

- [1] Compressed air supply port, opening
- [2] Compressed air supply port, closing
- [3] Alternative air supply port (sealed on delivery)
- [4] Sealing air connection (sealed on delivery)
- [5] Lubrication nipple (sealed on delivery)
- [6] Slot for proximity sensor
- [7] Centring disc

Size	B1	B2		B3	B4	B5	B6	B7	D1	D2
		with HGDT-...	with HGDT-...F							
[mm]	±0.5	±0.5	±0.5			±0.02	±0.02	-0.05 -0.1	∅ ±0.1	∅ ±0.1
HGDT-25-A	22	25	23.5	9.5	19	6	3	6	48	38
HGDT-25-A-G...										
HGDT-35-A	27	31	29	11	22	8	4	6.5	58	44
HGDT-35-A-G...										
HGDT-40-A	35	41	38	14	28	12	5	10	74	56
HGDT-40-A-G...										
HGDT-50-A	43.5	51.5	47.5	17.5	35	15	6	12	93	70
HGDT-50-A-G...										
HGDT-63-A	54	64	59	22.5	45	18	10	14	116	90
HGDT-63-A-G...										

Data sheet

Size [mm]	D3 ∅ H8	D4 ∅ H8/h7	D5 ∅	D6 ∅	D7 ∅	D8 ∅ H13	D9 ∅ H13	D10 ∅ H8	D11	D12 ∅	D13 ∅ H8/h7	EE	EE1
HGDT-25-A	3	5	3.2	M3	M4	5.9	3.3	14	M2	–	–	M5	M3
HGDT-25-A-G...													
HGDT-35-A	3	5	3.2	M3	M4	5.9	3.3	25	M3	3.2	5	M5	M3
HGDT-35-A-G...													
HGDT-40-A	4	7	5.3	M4	M6	9.4	5.1	25	M3	3.2	5	M5	M5
HGDT-40-A-G...													
HGDT-50-A	5	9	6.4	M6	M8	10.2	6.4	25	M5	5.3	7	G1/8	M5
HGDT-50-A-G...													
HGDT-63-A	5	9	6.4	M6	M8	10.4	6.4	25	M5	5.3	7	G1/8	M5
HGDT-63-A-G...													

Size [mm]	EE2	H1 ±0.05	H2 ±0.05	H3	H4	H5 ±0.1	H6 ±0.1	H7 –0.3	H8	H9 –0.02	H10 –0.2	H11 –0.3	L1 ±0.5
HGDT-25-A	M5	41.5	40.5	32.5	29.3	9	13.5	1.1	2.25±0.1	8.5	3.5	–	6
HGDT-25-A-G...													
HGDT-35-A	M5	46	45	37	33.5	9	18.5	1.1	3±0.02	12	3.5	1.1	7
HGDT-35-A-G...		52	51	43	39.5								
HGDT-40-A	M5	55	54	44	38.4	9	25	1.4	4.5±0.02	16	3.5	1.1	9
HGDT-40-A-G...		72	71	61	55.4								
HGDT-50-A	M5	64.5	63.5	50.5	45	12	32	1.9	5.5±0.02	19	3.5	1.4	9
HGDT-50-A-G...		82	81	68	62.5								
HGDT-63-A	M5	69	68	50	44.5	12	42	1.9	5.5±0.02	22	3.5	1.4	12
HGDT-63-A-G...		96	95	77	71.5								

Size [mm]	L2 ±0.1	L3 ±0.1	L4 ±0.02	L5	L6	T1 min.	T2 +0.1	T3 min.	T4 +0.2	T5 min.	T6 +0.1	T7 +0.1	T8 min.
HGDT-25-A	12	12	38	16.45	6±0.1	3.5	1.3	5	3.2	8	2	–	3
HGDT-25-A-G...													
HGDT-35-A	12	15	45	19.05	6±0.02	5	1.3	5.5	3.2	8	2	1.3	6
HGDT-35-A-G...													
HGDT-40-A	12	18	56	24.25	6±0.02	6	1.6	6.5	5.1	10	2	1.3	6
HGDT-40-A-G...													
HGDT-50-A	24	18	70	30.31	13±0.02	8	2.1	10.5	6.1	12	2	1.6	9
HGDT-50-A-G...													
HGDT-63-A	24	24	90	38.97	13±0.02	8	2.1	10.5	6.1	12	2	1.6	9
HGDT-63-A-G...													

Data sheet

Ordering data						
Size [mm]	Double-acting without compression spring		Single-acting or with gripping force retention			
	Part no.	Type	Opening		Closing	
	Part no.	Type	Part no.	Type	Part no.	Type
Standard						
25	540859	HGDT-25-A	540860	HGDT-25-A-G1	540861	HGDT-25-A-G2
35	540862	HGDT-35-A	540863	HGDT-35-A-G1	540864	HGDT-35-A-G2
40	540865	HGDT-40-A	540866	HGDT-40-A-G1	540867	HGDT-40-A-G2
50	540868	HGDT-50-A	540869	HGDT-50-A-G1	540870	HGDT-50-A-G2
63	540871	HGDT-63-A	540872	HGDT-63-A-G1	540873	HGDT-63-A-G2
High force						
25	560177	HGDT-25-A-F	560178	HGDT-25-A-F-G1	560179	HGDT-25-A-F-G2
35	560180	HGDT-35-A-F	560181	HGDT-35-A-F-G1	560182	HGDT-35-A-F-G2
40	560183	HGDT-40-A-F	560184	HGDT-40-A-F-G1	560185	HGDT-40-A-F-G2
50	560186	HGDT-50-A-F	560187	HGDT-50-A-F-G1	560188	HGDT-50-A-F-G2
63	560189	HGDT-63-A-F	560190	HGDT-63-A-F-G1	560191	HGDT-63-A-F-G2

Accessories

Adapter kit HAPG

Material:
Wrought aluminium alloy
Free of copper and PTFE
RoHS-compliant

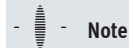

Note

The kit includes the individual mounting interface as well as the necessary mounting material.

Download CAD data → www.festo.com

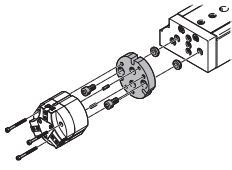
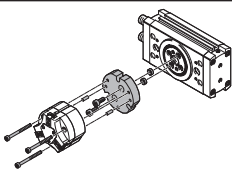
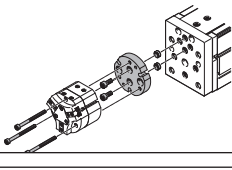
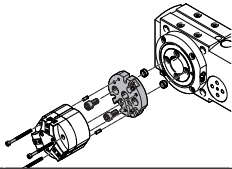
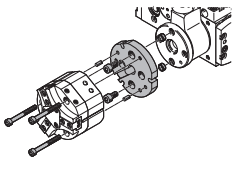
Permissible drive/gripper combinations with adapter kit					
Combination	Drive Size	Gripper Size	Adapter kit CRC ¹⁾	Part no.	Type
	DGSL	HGDT	HAPG 2		
	16	25		542439	HAPG-SD2-32
	16	35		542436	HAPG-94
	20, 25	35		548805	ZBV-9-7
	20, 25	40		542436	HAPG-94
	25	50		542437	HAPG-95
				542443	HAPG-SD2-36
				548806	ZBV-12-9
	DRRD	HGDT	DHAA 2		
	16	25		2079812	DHAA-G-Q11-16-B7/B7G-25
	20	25		2079695	DHAA-G-Q11-20-B7/B7G-25
	20	35		2077056	DHAA-G-Q11-20-B7-35
	25	35		1735057	DHAA-G-Q11-25-B7-35
	25	40		1735103	DHAA-G-Q11-25-B7-40
	32	40		2077253	DHAA-G-Q11-32-B7-40
	32	50		2077335	DHAA-G-Q11-32-B7-50
	35	50		2079063	DHAA-G-Q11-35-B7-50
	35, 40	63		2079274	DHAA-G-Q11-3 5/40-B7-63
	DRRD	HGDT-G	DHAA 2		
	20	35		2832455	DHAA-G-Q11-20-B7G-35
	25	35		2832483	DHAA-G-Q11-25-B7G-35
	25	40		2832545	DHAA-G-Q11-25-B7G-40
	32	40		2832575	DHAA-G-Q11-32-B7G-40
	32	50		2832600	DHAA-G-Q11-32-B7G-50
	35	50		2832617	DHAA-G-Q11-35-B7G-50
	35, 40	63		2832631	DHAA-G-Q11-3 5/40-B7G-63
	EGSL	HGDT	HAPG 2		
	35	25		542433	HAPG-97
	45, 55	25		542439	HAPG-SD2-32
	45, 55, 75	35		542436	HAPG-94
	75	40		542437	HAPG-95
	75	50		542443	HAPG-SD2-36
	ERMB	HGDT	HAPG 2		
	20, 25	25		542440	HAPG-SD2-33
	20, 25, 32	35		542441	HAPG-SD2-34
	25, 32	40		542442	HAPG-SD2-35
	32	50		542443	HAPG-SD2-36
	EHMB	HGDT	HAPG 2		
	20	35		542441	HAPG-SD2-34
	20	40		542442	HAPG-SD2-35
	20	50		542443	HAPG-SD2-36

1) Corrosion resistance class CRC 2 to Festo standard FN 940070

Moderate corrosion stress. Indoor applications in which condensation can occur. External visible parts with primarily decorative surface requirements which are in direct contact with a normal industrial environment.

Accessories

Gripper jaw blank BUB-HGDT

(3 included in the scope of delivery)

Material:

Wrought aluminium alloy

Free of copper and PTFE

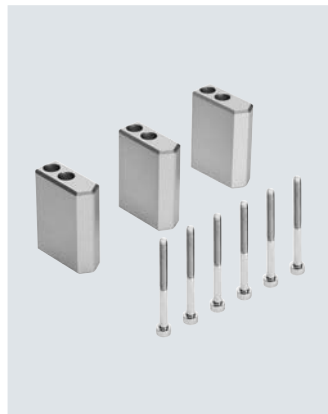

BUB-HGDT-25

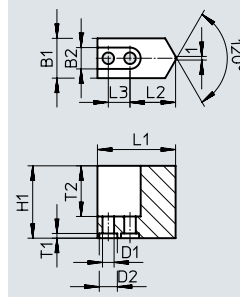

BUB-HGDT-35....-63

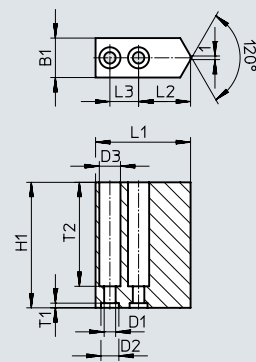



Dimensions and ordering data

For size	B1	B2	D1	D2	D3	H1	L1
[mm]	±0.05	+0.22	∅ H13	∅ H8	∅ +0.22	±0.05	±0.05
25	11	5.9	3.2	5	–	20	21.6
35	11	–	3.2	5	5.9	35	26.5
40	16	–	4.3	7	7.4	50	34
50	20	–	6.3	9	10.4	65	42
63	24	–	6.3	9	10.4	80	52

For size	L2	L3	T1	T2	Weight per blank	Part no.	Type
[mm]	±0.02 ¹⁾ ±0.1 ²⁾	±0.01 ¹⁾ ±0.1 ¹⁾	+0.1		[g]		
25	12.6	6	1.3	14	10	541101	BUB-HGDT-25
35	14.5	8	1.3	29	22	541102	BUB-HGDT-35
40	17	12	1.6	45	59	541103	BUB-HGDT-40
50	21	15	2.1	58	112	541104	BUB-HGDT-50
63	24	18	2.1	73	222	541105	BUB-HGDT-63

- 1) For centring
2) For through-hole



Accessories

Ordering data						
	For size [mm]	Comment	Weight [g]	Part no.	Type	PU ¹⁾
Centring sleeve ZBH						Data sheets → Internet: zbh
	25, 35	For centring the gripper jaw blanks/gripper fingers on the gripper jaws	1	8146543	ZBH-5-B	10
	40		1	8146544	ZBH-7-B	
	50, 63		1	8137184	ZBH-9-B	
	35, 40	For lateral centring of gripper fingers on the gripper jaws	1	8146543	ZBH-5-B	
	50, 63		1	8146544	ZBH-7-B	
Central mounting SLZZ						Data sheets → Internet: slzz
	25	For centring the gripper during mounting	21	150900	SLZZ-1 6/10	-
	35, 40, 50, 63		40	150901	SLZZ-2 5/16	
Blanking plug B						Data sheets → Internet: blanking plug
	25 ... 63	For sealing the compressed air supply ports	0.6	30979	B-M3-S9	10
			1	174308	B-M5-B	
			5	3568	B-1/8	

1) Packaging unit

Ordering data – Proximity sensor for C-slot, magneto-resistive						
	Type of mounting	Electrical connection, outlet direction of connection	Switching output	Cable length [m]	Part no.	Type
N/O contact						
	Insertable in the slot from above	Cable, 3-wire, in-line	PNP	2.5	551373	SMT-10M-PS-24V-E-2.5-L-OE
		Plug M8x1, 3-pin, in-line		0.3	551375	SMT-10M-PS-24V-E-0.3-L-M8D

Ordering data – Proximity sensor for C-slot, magneto-resistive						
	Type of mounting	Electrical connection, outlet direction of connection	Switching output	Cable length [m]	Part no.	Type
N/O contact						
	Insertable in the slot lengthwise	Cable, 3-wire, lateral	PNP	2.5	547862	SMT-10G-PS-24V-E-2.5Q-OE
		Plug M8x1, 3-pin, lateral		0.3	547863	SMT-10G-PS-24V-E-0.3Q-M8D
	Insertable in the slot lengthwise	Cable, 3-wire, lateral	NPN	2.5	8065030	SMT-10G-NS-24V-E-2.5Q-OE
		Plug M8x1, 3-pin, lateral		0.3	8065029	SMT-10G-NS-24V-E-0.3Q-M8D

Ordering data – Connecting cables					
	Electrical connection, left	Electrical connection, right	Cable length [m]	Part no.	Type
	Straight socket, M8x1, 3-pin	Cable, open end, 3-wire	2.5	541333	NEBU-M8G3-K-2.5-LE3
			5	541334	NEBU-M8G3-K-5-LE3
	Angled socket, M8x1, 3-pin	Cable, open end, 3-wire	2.5	541338	NEBU-M8W3-K-2.5-LE3
			5	541341	NEBU-M8W3-K-5-LE3

Festo - Your Partner in Automation



1 Festo Inc.
5300 Explorer Drive
Mississauga, ON L4W 5G4
Canada

Festo Customer Interaction Center
Tel: 1 877 463 3786
Fax: 1 877 393 3786
Email: customer.service.ca@festo.com

2 Festo Pneumatic
Av. Ceylán 3,
Col. Tequesquináhuac
54020 Tlalnepantla,
Estado de México

Multinational Contact Center
01 800 337 8669
ventas.mexico@festo.com

3 Festo Corporation
1377 Motor Parkway
Suite 310
Islandia, NY 11749

Festo Customer Interaction Center
1 800 993 3786
1 800 963 3786
customer.service.us@festo.com

4 Regional Service Center
7777 Columbia Road
Mason, OH 45040

Connect with us



www.festo.com/socialmedia



www.festo.com

Subject to change