

Parallel gripper HEPP

FESTO

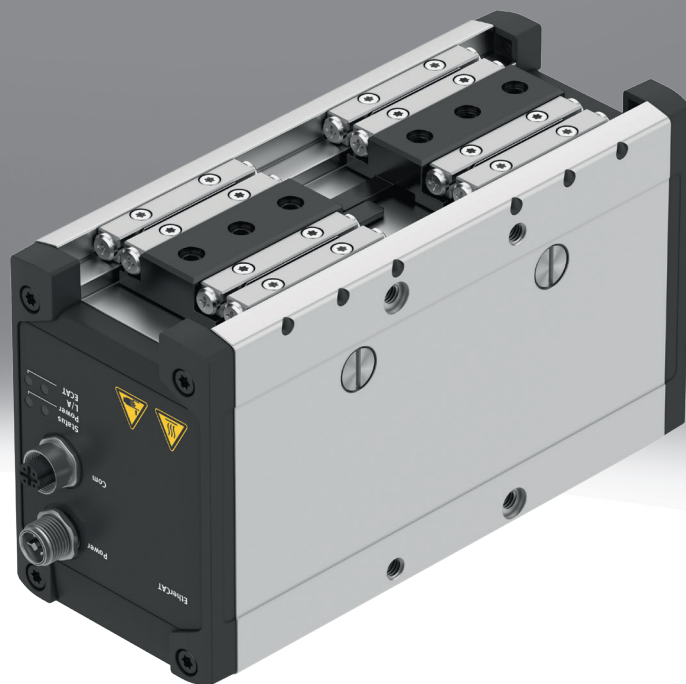

Characteristics

At a glance

- Compact design
- No external controller required
- For moving medium to large parts
- Flexible position adjustment
- Flexible position control
- Flexible force control
- Simple installation and commissioning

Application area:

- Handling and assembly technology
- Laboratory automation
- Electronics manufacturing

Diagrams

Further information → [hepp](#)



The diagrams shown in this document are also available online. These can be used to display precise values.

Trademarks

The following are the registered trademarks of the respective trademark owner in certain countries:

- PROFINET®
- EtherCat®
- EtherNet/IP®

Bus protocol/activation

The gripper HEPP can be connected to the automation system CPX-E PLC via the EtherCAT® interface

[EC] EtherCAT®

EtherCAT®

[EP] EtherNet/IP

EtherNet/IP™

[PN] Profinet

**PROFI
NET**

Brake

The holding brake should not be used as a safety brake.

Type code

001	Series
HEPP	Parallel gripper HEPP

002	Size [mm]
28	28
36	36
42	42

003	Complete stroke [mm]
30	30
45	45
56	56

004	Bus protocol/activation
EC	EtherCAT®
EP	EtherNet/IP
PN	Profinet

005	Brake
	None
B	With brake

Datasheet

General technical data			
Size	28	36	42
Design	Toothed belt Electric gripper With brake With ball screw		
Guide	Roller bearing guide		
Ready status indication	LED		
Gripper function	Parallel		
Number of gripper jaws	2		
Stroke per gripper jaws	15 mm	22.5 mm	28 mm
Total stroke	30 mm	45 mm	56 mm
Total gripping force ¹⁾	320 N	520 N	680 N
Gripping force per gripper jaw ²⁾	160 N	260 N	340 N
Nominal motor current	0.9 A	1.3 A	5 A
Nominal torque	0.115 Nm	0.183 Nm	0.185 Nm
Positioning speed per gripper finger	40 mm/s		50 mm/s
Positioning acceleration per gripper finger	1 m/s ²		
Repetition accuracy, gripper	0.02 mm		0.01 mm
Gripping speed per gripper finger	3 mm/s		
Max. gripper jaw backlash Sz	0.35 mm		
Position detection	Motor encoder		
Type of mounting	Via female thread and centring sleeve		
Electrical connection	2x M12		
Mounting position	optional		
Product weight	1,400 g	2,100 g	2,600 g
Controller operating mode	Interpolated mode via fieldbus		

1) Total gripping force = 2x gripping force per gripper jaw

2) Gripping force tolerance: ±15% F.S. for HEPP-42, ±20% F.S. for HEPP-36, ±25% F.S. for HEPP-28

Electrical data			
Size	28	36	42
Nominal voltage load voltage DC	24		
Permissible range for load power supply	± 10%		
Max. current consumption, load	2 A	3 A	
Nominal voltage for logic power supply DC	24 V		
Permissible range for logic voltage	± 10%		
Max. current consumption, logic	1 A		

Technical data – Encoder			
Size	28	36	42
Rotor position sensor	Absolute single-turn encoder		
Rotor position sensor, encoder measuring principle	Magnetic		

Datasheet

Fieldbus interface

Field bus, protocol	EtherCAT® EtherNet/IP PROFINET IRT PROFINET RT
Communication profile	CiA402, EoE (Ethernet over EtherCAT®), FoE (File over EtherCAT®), PROFIdrive, DriveProfile
Configuration support	EDS file, ESI file, GSDML file
Field bus, connection type	Socket
Field bus, connection system	M12x1, D-coded to EN 61076-2-101
Field bus, connection pattern	4

Static load characteristics at the gripper jaws

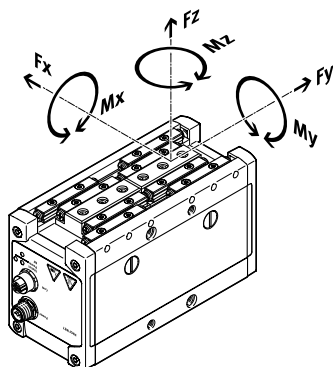

The specified permissible forces and torques refer to one gripper jaw. They include the lever arm, additional applied loads due to the workpiece or external gripper fingers and acceleration forces occurring during movement. The zero position of the coordinate system (gripper jaw guide slot) must be taken into consideration when calculating the torques.

Size	28	36	42
Max. force on gripper jaw Fz static	680 N	1,100 N	
Max. torque at gripper Mx static	6.5 Nm	13.9 Nm	
Max. torque at gripper My static	14.5 Nm	34.5 Nm	38.5 Nm
Max. torque at gripper Mz static	6.5 Nm	13.9 Nm	

Mass moment of inertia

Size	28	36	42
Mass moment of inertia	30 kgcm ²	54 kgcm ²	85 kgcm ²

Operating and environmental conditions

Ambient temperature ¹⁾	0 ... 50°C
Degree of protection	IP40
Relative air humidity	0 - 95%, Non-condensing
Corrosion resistance class CRC ²⁾	0 - No corrosion stress
Vibration resistance	Transport application test with severity level 2 to FN 942017-4 and EN 60068-2-6
Shock resistance	Shock test with severity level 2 to FN 942017-5 and EN 60068-2-27
Sound pressure level	60 dB(A)
CE mark (see declaration of conformity) ³⁾	To EU EMC Directive In accordance with EU RoHS Directive
CE marking (see declaration of conformity) ⁴⁾	To UK instructions for EMC To UK RoHS instructions
KC mark	KC-EMV
Lubrication interval for guide components	1 MioCyc
Cleanroom class	Class 6 according to ISO 14644-1

1) For HEPP-42 at 40...50°C, derating to 80% of the nominal current.

2) More information: www.festo.com/x/topic/crc

3) More information www.festo.com/catalogue/hepp → Support/Downloads.

4) More information www.festo.com/catalogue/hepp → Support/Downloads.

Datasheet

Materials

Material housing	Anodised aluminium
Material gripper jaws	Steel
RoHS status	RoHS compliant in accordance with EU directive
LABS (PWIS) conformity	VDMA24364 zone III
Suitability for the production of Li-ion batteries	Metals with more than 1% by mass of copper, zinc or nickel by mass are excluded from use. Exceptions are nickel in steel, chemically nickel-plated surfaces, printed circuit boards, cables, electrical plug connectors and coils, Metals with more than 1% by mass of copper, zinc or nickel are excluded from use. Exceptions are nickel in steel, chemically nickel-plated surfaces, printed circuit boards, cables, electrical plug connectors and coils

Total gripping force F as a function of motor current I

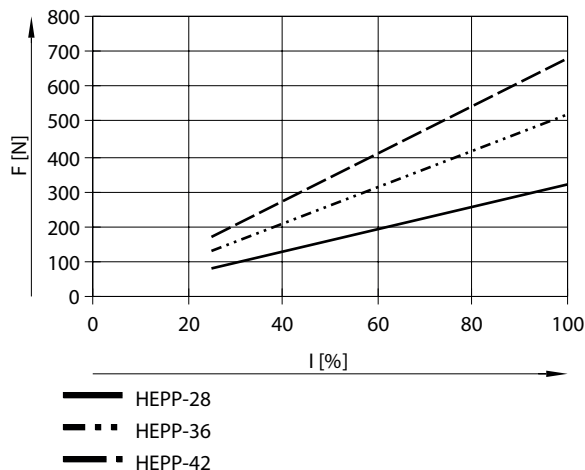

The values in the diagram apply at a speed ≤ 3 mm/s per gripper jaw.
If the nominal current is less than 25%, the repetition accuracy of the force is reduced.

Motor current I as a function of ambient temperature t

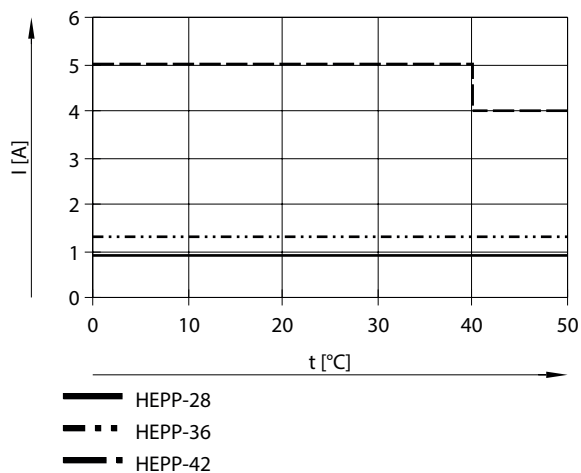

Gripping force F as a function of lever arm x

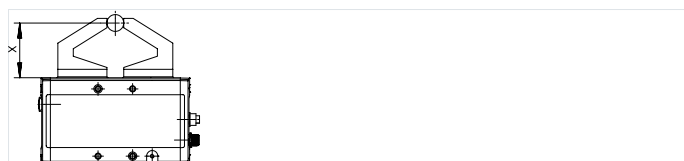

Lever arm x = distance from the gripper jaw surface to the gripper's centre point

Datasheet

Gripping force F as a function of lever arm x for HEPP-28

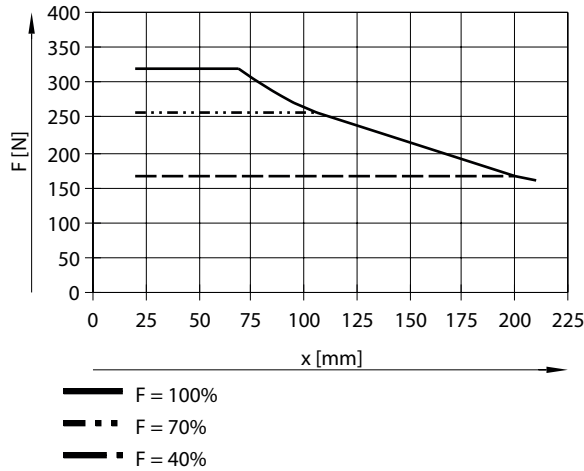

With longer gripper fingers, a larger reserve of force is recommended due to the longer lever arm.

Gripping force F as a function of lever arm x for HEPP-36

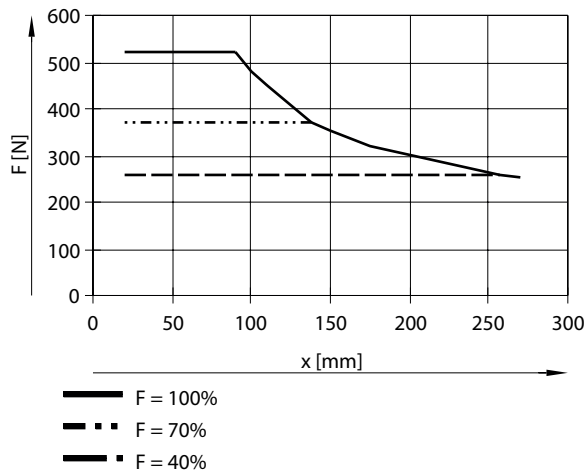

With longer gripper fingers, a larger reserve of force is recommended due to the longer lever arm.

Gripping force F as a function of lever arm x for HEPP-42

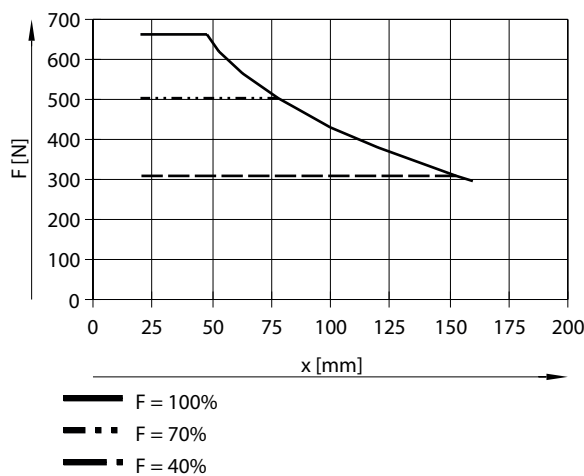

With longer gripper fingers, a larger reserve of force is recommended due to the longer lever arm.

Datasheet

Gripping force F as a function of gripping point x/y

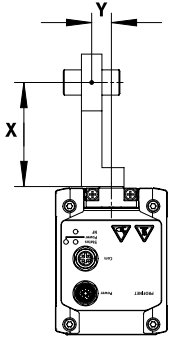

- Gripping point x = vertical distance outside the centre of the gripper jaws
 Gripping point y = horizontal distance outside the centre of the gripper jaws
- The service life of the electric gripper may be reduced if the position of the gripping point is outside the limit value.
 - Ensure the gripping point is as short as possible to increase the service life.
 - The values in the diagram apply at a speed ≤ 3 mm/s per gripper jaw.

Gripping force F as a function of gripping point x/y for HEPP-28

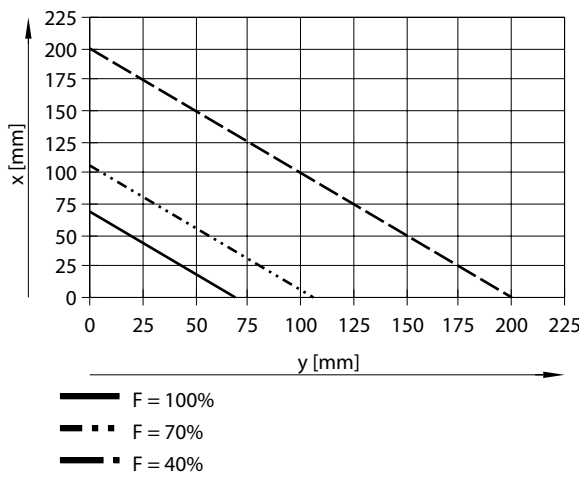

- Gripping point x = horizontal distance outside the centre of the gripper jaws
 Gripping point y = vertical distance outside the centre of the gripper jaws

Gripping force F as a function of gripping point x/y for HEPP-36

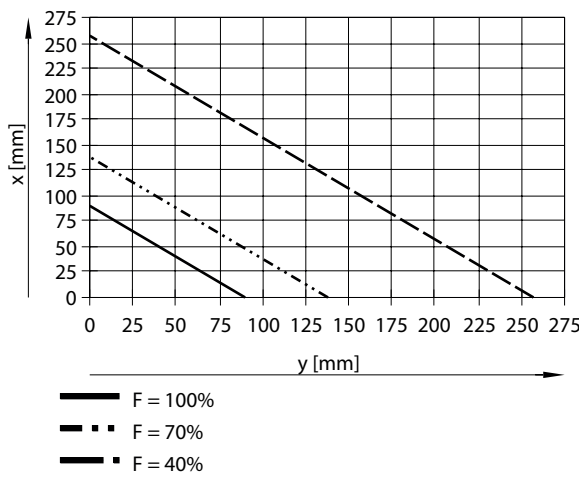

- Gripping point x = horizontal distance outside the centre of the gripper jaws
 Gripping point y = vertical distance outside the centre of the gripper jaws

Datasheet

Gripping force F as a function of gripping point x/y for HEPP-42

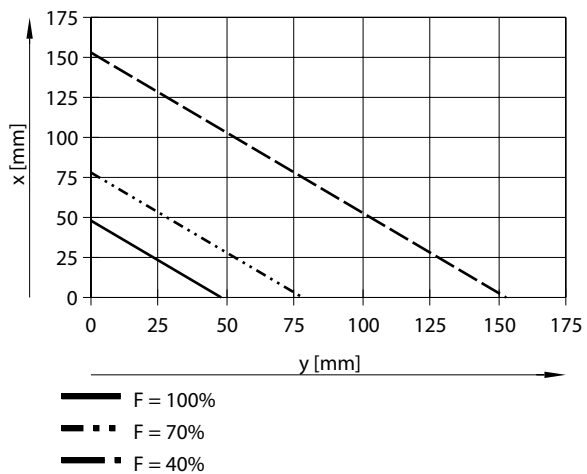

Gripping point x = horizontal distance outside the centre of the gripper jaws
 Gripping point y = vertical distance outside the centre of the gripper jaws

Dimensions

Dimensions – Parallel gripper HEPP

Download CAD data → www.festo.com

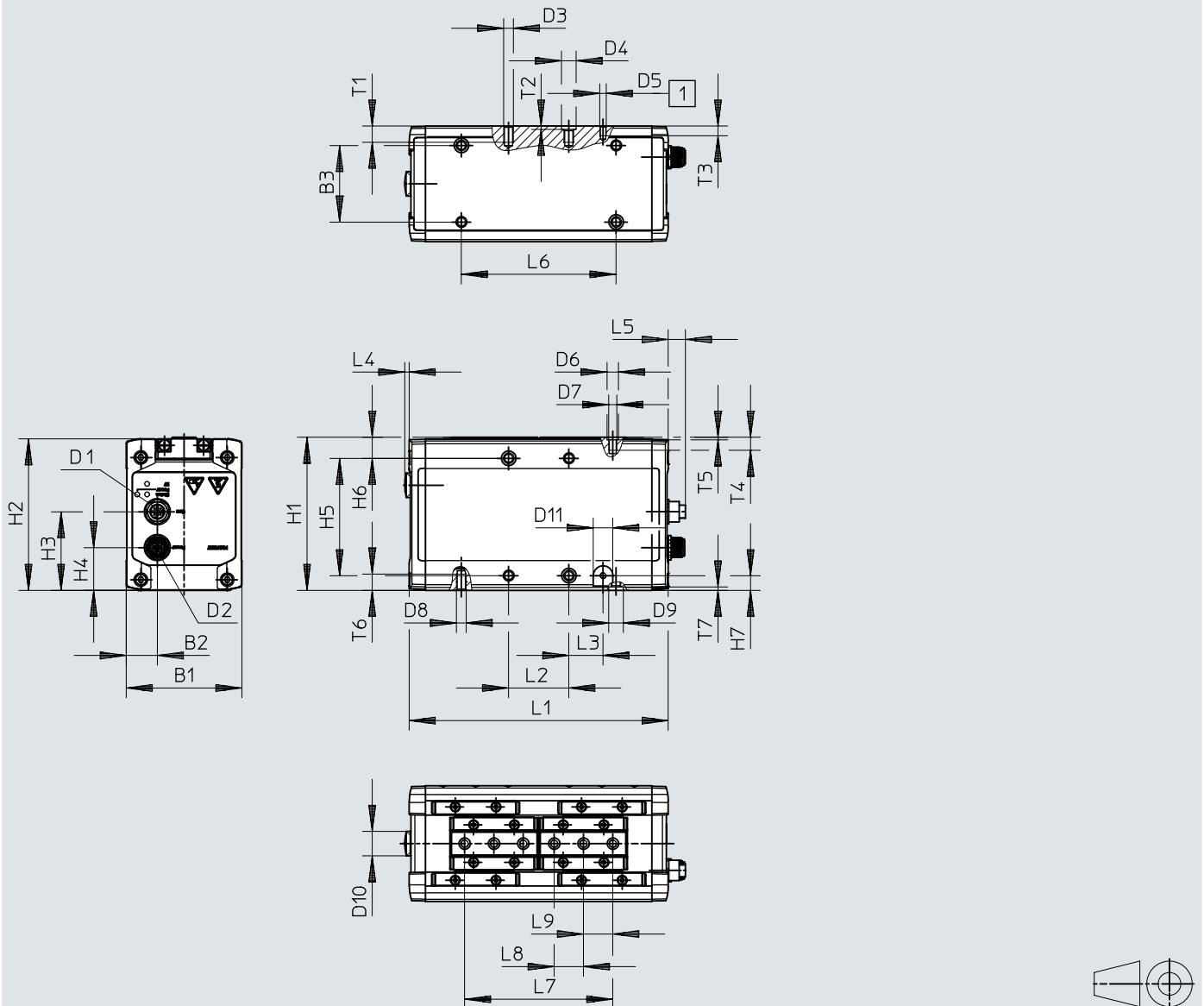

[1] Threaded hole for earth connection

Dimensions

	B1 ±0,3	B2	B3 ¹⁾ ±0,02	D1	D2	D3	D4 ∅ H8	D5	D6 ∅ H8	D7	D8	D9 ∅ H8
HEPP-28	66	19,1	44	M12x1	M12x1	M5	7	M4	5	M3	M5	7
HEPP-36	71	19,1	47	M12x1	M12x1	M6	9	M4	7	M5	M6	9
HEPP-42	75	19,1	48	M12x1	M12x1	M6	9	M4	7	M5	M6	9

	D10	D11	H1 ±0,75	H2	H3	H4	H5 ¹⁾	H6	H7	L1 ±0,8	L2 ¹⁾ ±0,02	L3	L4
HEPP-28	15	12	88	87	46,2	24,2	70	10,5	7,5	146,1	34	16,3	3,1
HEPP-36	15	12	94	93	48,2	26,2	72	13	9	159	37	21	2,8
HEPP-42	15	12	106	105	47,7	25,7	84	13,5	8,5	182	45	21,5	2,8

	L5	L6 ±0,02	L7 ²⁾ ±0,4	L7 ³⁾	L8 ¹⁾ ±0,02	L9 ¹⁾ ±0,02	T1 min.	T2 +0,15	T3	T4 min.	T5 +0,1	T6	T7 +0,15
HEPP-28	10,9	82	79	109	15	15	10	1,6	6	5,5	1,3	8	1,6
HEPP-36	10,6	95	91	136	18	18	10	2,1	6	8	1,6	10	2,1
HEPP-42	10,6	120	91	147	18	18	12	2,1	min.6	8	1,6	10	2,1

1) ±0.02 mm for centring; ±0.1 mm for the threads

2) closing

3) open

Dimensions

Dimensions – Mounting kit DHAS-ME-60/-80

Download CAD data → www.festo.com

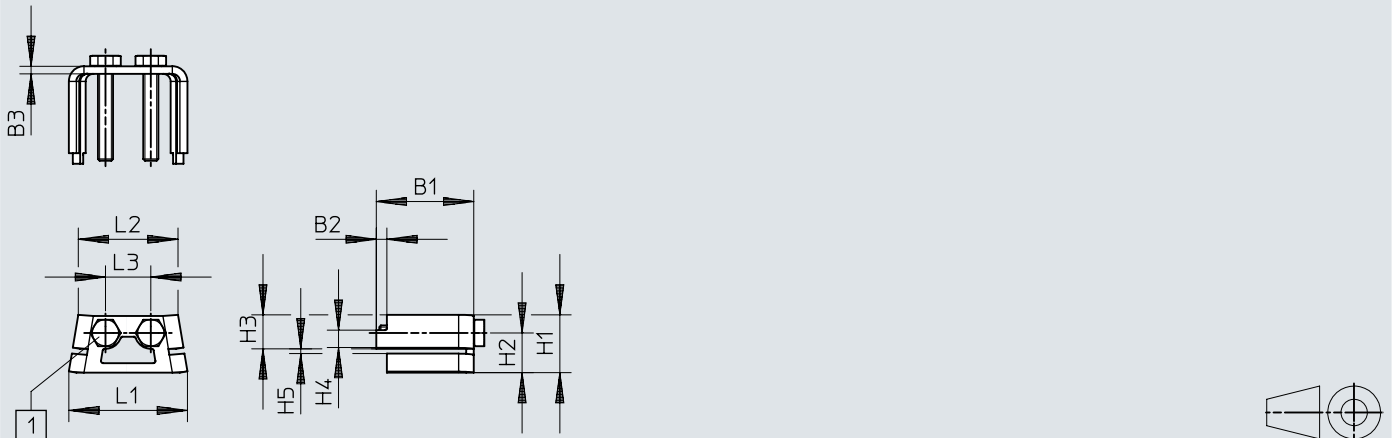

[1] Screws for size 60: ISO 4017-M3x22-A2-70; screws for size 80: ISO 4017-M4x25-A2-70

	B1	B2	B3	H1	H2	H3	H4	H5	L1	L2	L3
			±0,1					±0,1			±0,1
DHAS-ME-H9-60	22,8	2,8	2	10,3	6,7	7	3,6	1,3	20,7	17,4	7
DHAS-ME-H9-80	25,8	2,8	2	15,3	10,5	9	4,6	1,3	31,4	26,4	12

Dimensions

Dimensions – Mounting kit DHAS-ME-120

Download CAD data → www.festo.com

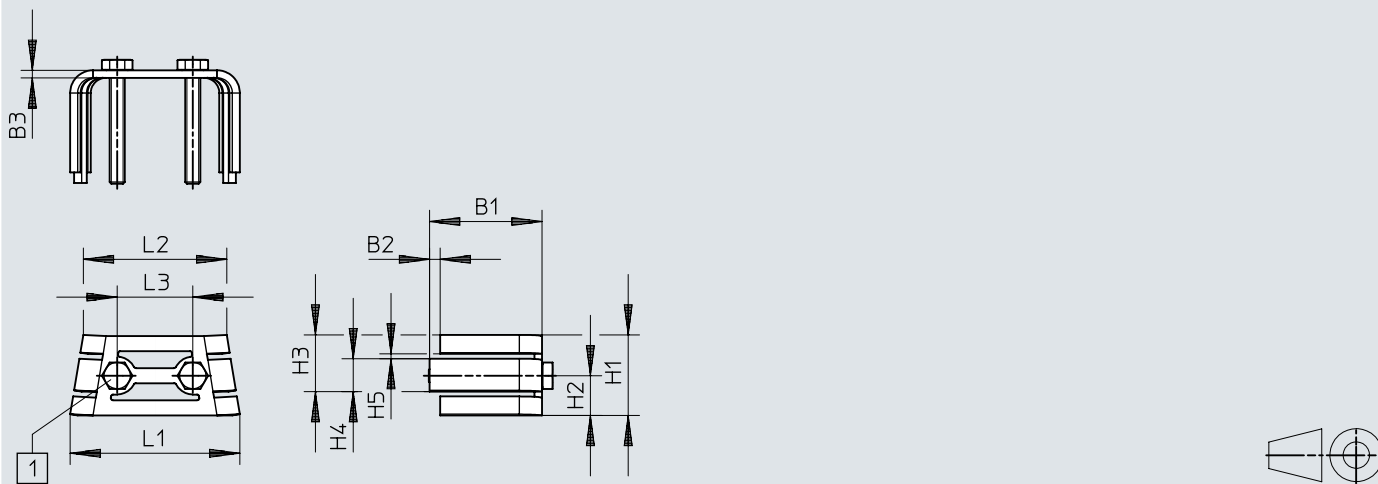

[1] Screws for size 120: ISO 4017-M4x30-A2-70

	B1	B2	B3	H1	H2	H3	H4	H5	L1	L2	L3
			±0,1					±0,1			±0,1
DHAS-ME-H9-120	29,8	2,8	2	21,3	10,5	15	8,7	1,3	44,9	38	20

Ordering data

Ordering data					
	Size	Total stroke	Fieldbus link	Part no.	Type
	28	30 mm	EtherCAT	8146668	HEPP-28-30-EC
				8146667	HEPP-28-30-EC-B
			EtherNet/IP	8146670	HEPP-28-30-EP
				8146669	HEPP-28-30-EP-B
			PROFINET	8117631	HEPP-28-30-PN
				8146666	HEPP-28-30-PN-B
	36	45 mm	EtherCAT	8146662	HEPP-36-45-EC-B
				8146663	HEPP-36-45-EC
			EtherNet/IP	8146665	HEPP-36-45-EP
				8146664	HEPP-36-45-EP-B
			PROFINET	8117630	HEPP-36-45-PN
				8146661	HEPP-36-45-PN-B
	42	56 mm	EtherCAT	8146657	HEPP-42-56-EC-B
				8146658	HEPP-42-56-EC
			EtherNet/IP	8146660	HEPP-42-56-EP
8146659				HEPP-42-56-EP-B	
PROFINET			8146656	HEPP-42-56-PN-B	
			8117629	HEPP-42-56-PN	

Peripherals

Peripherals overview

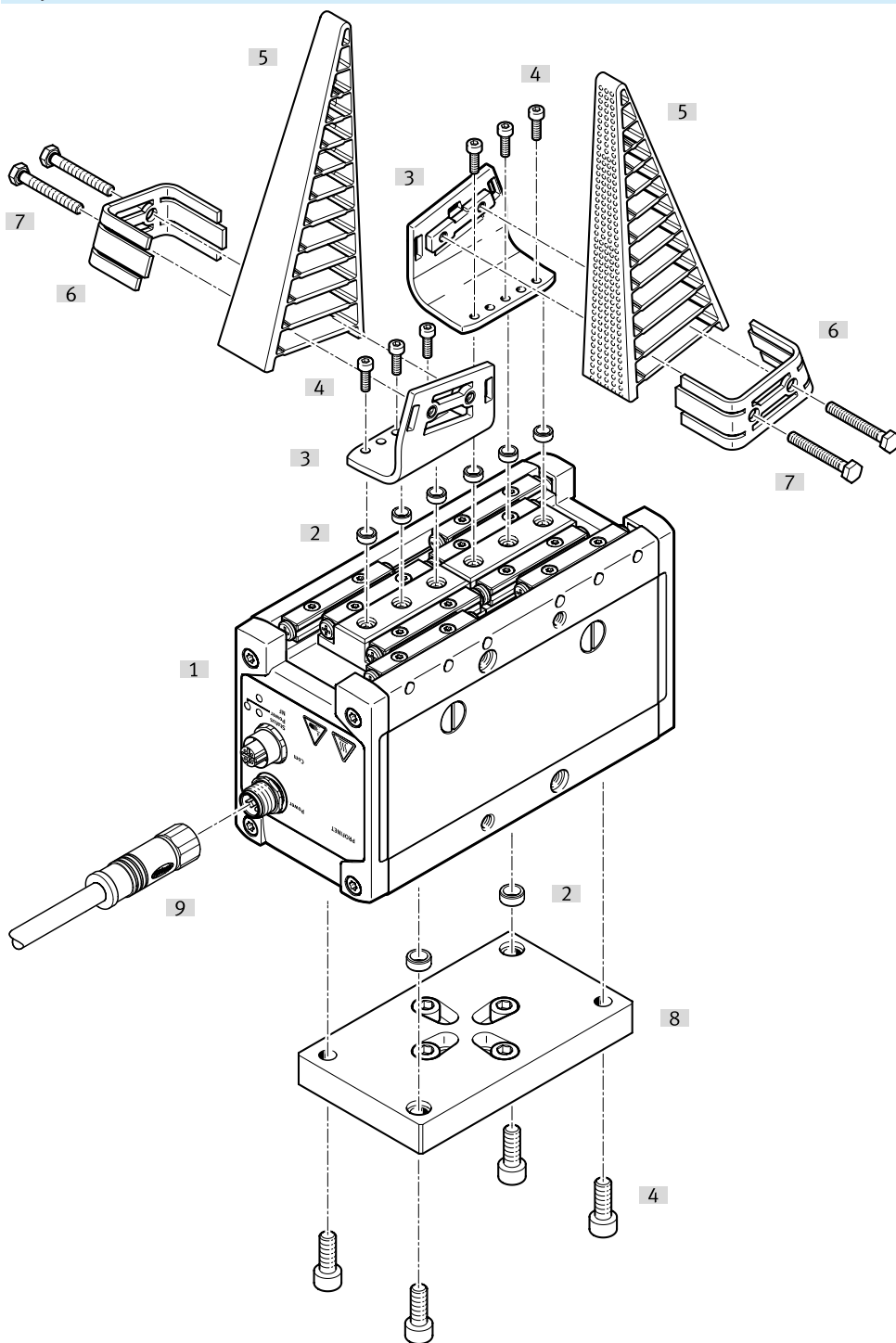

Accessories			→ Page/Internet
Type/order code	Description		
[1] Parallel gripper HEPP	Electric parallel gripper		hepp
[2] Mounting bracket DHAS-MA	For mounting the gripper finger on the gripper		16
[3] Adaptive gripper finger DHAS	For gentle and flexible gripping		16
[4] Mounting kit DHAS-ME	For mounting the gripper finger on the gripper		16
[5] Adapter kit DHAA	Connecting plate between gripper and drive/axis		17
[6] Connecting cable NEBM	To control the parallel gripper		16

Accessories

Adaptive gripper finger DHAS

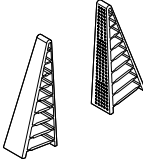
	Suitability for the production of Li-ion batteries	Material clamp jaws	Product weight	Part no.	Type
	F1a	TPE-U(PU)	13 g	3998964	DHAS-GF-80-U-BU
			29 g	3998959	DHAS-GF-120-U-BU

Mounting kit DHAS-ME

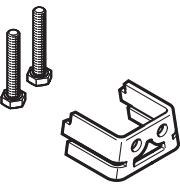
	Material adapter	Product weight	Part no.	Type
	High-alloy stainless steel	13 g	4463570	DHAS-ME-H9-80
		23 g	4461433	DHAS-ME-H9-120

Mounting bracket DHAS-MA

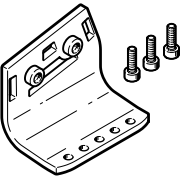
	Material adapter bracket	Product weight	Part no.	Type
	High-alloy stainless steel	60 g	8154200	DHAS-MA-B24-80
		85 g	8154065	DHAS-MA-B24-120

Centring sleeve ZBH for centring the gripper jaws

	Material sleeve	Size of pack	Product weight	Part no.	Type
	Steel	10	1 g	8146544	ZBH-7-B
				8146543	ZBH-5-B

Centring sleeve ZBH for centring the gripper

	Material sleeve	Size of pack	Product weight	Part no.	Type
	Steel	10	1 g	8146544	ZBH-7-B
			2 g	8137184	ZBH-9-B

Connecting cable NEBM, straight

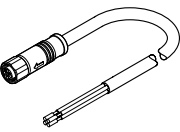
	Electrical connection 1, connector system	Electrical connection 2, connector system	Electrical connection 2, number of connections/cores	Cable length	Part no.	Type
	M12x1, T-coded according to EN 61076-2-111	Open end	4	3 m	8140935	NEBM-T12G4-R-3-LE4
				5 m	8140936	NEBM-T12G4-R-5-LE4
				10 m	8140937	NEBM-T12G4-R-10-LE4

Accessories

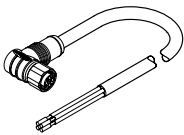
Connecting cable NEBM, angled						
	Electrical connection 1, connector system	Electrical connection 2, connector system	Electrical connection 2, number of connections/cores	Cable length ¹⁾	Part no.	Type
	M12x1, T-coded according to EN 61076-2-111	Open end	4	3 m	8140938	NEBM-T12W4-R-3-LE4
				5 m	8140939	NEBM-T12W4-R-5-LE4
				10 m	8140940	NEBM-T12W4-R-10-LE4

1) The angled cables and leads are positioned at a 45° angle to the gripper.

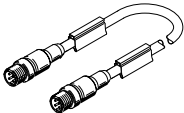
Connecting cable NEBC for fieldbus interface, M12x1						
	Electrical connection 1, connector system	Electrical connection 2, connector system	Cable length	Part no.	Type	
	M12x1, D-coded to EN 61076-2-101	M12x1, D-coded to EN 61076-2-101	0.5 m	8040446	NEBC-D12G4-ES-0.5-S-D12G4-ET	
			1 m	8040447	NEBC-D12G4-ES-1-S-D12G4-ET	
			3 m	8040448	NEBC-D12G4-ES-3-S-D12G4-ET	
			5 m	8040449	NEBC-D12G4-ES-5-S-D12G4-ET	
			10 m	8040450	NEBC-D12G4-ES-10-S-D12G4-ET	

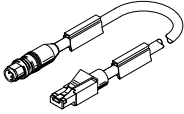
Connecting cable NEBC for fieldbus interface, RJ45						
	Electrical connection 1, connector system	Electrical connection 2, connector system	Cable length	Part no.	Type	
	M12x1, D-coded to EN 61076-2-101	RJ45 to IEC 60603-7-3	1 m	8040451	NEBC-D12G4-ES-1-S-R3G4-ET	
			3 m	8040452	NEBC-D12G4-ES-3-S-R3G4-ET	
			5 m	8040453	NEBC-D12G4-ES-5-S-R3G4-ET	
			10 m	8040454	NEBC-D12G4-ES-10-S-R3G4-ET	

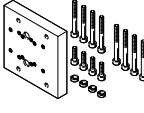
Adapter kit DHAA				
	Description	Material adapter plate	Part no.	Type
	for HEPP-28 with EGSC-32/45/60	Anodised wrought aluminium alloy	8150924	DHAA-G-E19-32-B24-28
	for HEPP-28 with ELCC-70		8150926	DHAA-G-E21-70-B24-28
	for HEPP-28 with EGSL-45/55/75		8150920	DHAA-G-E8-45-B24-28
	For HEPP-28 with ERMB-20		8154540	DHAA-G-R1-20-B24-28
	For HEPP-28 with ERMB-25		8154544	DHAA-G-R1-25-B24-28
	for HEPP-28 with EGSL-35		8150917	DHAA-G-E8-35-B24-28
	for HEPP-28 with ELCC-60		8150928	DHAA-G-E21-60-B24-28
	for HEPP-36 with ELCC-60		8150930	DHAA-G-E21-60-B24-36
	for HEPP-36 with ELCC-70		8150935	DHAA-G-E21-70-B24-36
	for HEPP-36 with ELCC-90		8150932	DHAA-G-E21-90-B24-36
	for HEPP-36 with EGSL-55/75		8150914	DHAA-G-E8-55-B24-36
	For HEPP-36 with ERMB-20		8154542	DHAA-G-R1-20-B24-36
	For HEPP-36 with EGSC-45/60		8150922	DHAA-G-E19-45-B24-36
	for HEPP-42 with ELCC-70		8150953	DHAA-G-E21-70-B24-42
	for HEPP-42 with ELCC-90/110		8150939	DHAA-G-E21-90-B24-42
	For HEPP-42/36 with ERMB-25		8154546	DHAA-G-R1-25-B24-42
	For HEPP-42 with ERMB-32		8154548	DHAA-G-R1-32-B24-42