

One-way flow control valve GRxA, GRxZ

FESTO

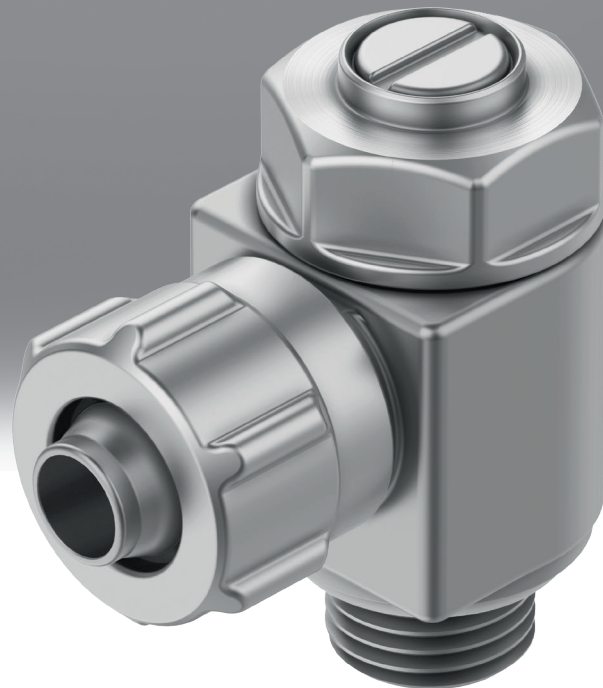

Characteristics

At a glance

- Functional combination of one-way flow control valve and piloted check valve
- Flow control valve, flow control at one end
- Polymer, metal or stainless steel design
- Standard, mini, in-line variants with different flow rate ranges
- Connections: thread at both ends, push-in connector at both ends, thread/push-in connector

Product segmentation



Festo Core Range

Solves the majority of your automation tasks

With the Festo Core Range, we have selected the most important products and functions from our broad product catalogue, and added the quickest delivery. The Core Range offers you the best value with the expected high Festo quality.

- Quickest delivery, worldwide – wherever, whenever
- Expected high Festo quality
- Easy and fast to select

Diagrams

Further information → [grla/grlz](#)



The diagrams shown in this document are also available online. These can be used to display precise values.

Series

One-way flow control valves can be used to regulate the piston speed of pneumatic drives as they advance and retract.

[GRLA] One-way flow control valve

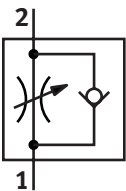

The throttle function only works in the exhaust air direction, the non-return function works in the opposite direction.

[GRLZ] One-way flow control valve

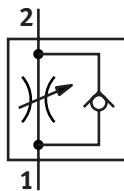

The throttle function only works in the supply air direction, the non-return function works in the opposite direction.

[GRLSA] One-way flow control valve

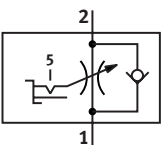

The throttle function only works in the exhaust air direction, the non-return function works in the opposite direction. Gradual preselection of the flow rate range using a rotary switch and infinitely variable precision adjustment with hex key using a scale.

[CRGRLA] One-way flow control valve, corrosion resistant

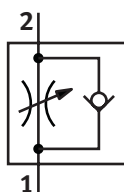

The throttle function only works in the exhaust air direction, the non-return function works in the opposite direction.

Flow rate characteristic

[LF] Low flow

Precise setting for low piston speeds

[MF] Medium flow

Precise setting for medium piston speeds

Type code

001	Series
GRLA	One-way flow control valve
GRLSA	One-way flow control valve
CRGRLA	One-way flow control valve, corrosion resistant
GRLZ	One-way flow control valve

002	Pneumatic connection
M3	Male thread M3
M5	Male thread M5
1/8	Male thread G1/8
1/4	Male thread G1/4
3/8	Male thread G3/8
1/2	Male thread G1/2
3/4	Male thread G3/4

003	Pneumatic connection 1
	Connection size as for port 1 or 2
QS-3	Push-in connector 3 mm
QS-4	Push-in connector 4 mm
QS-6	Push-in connector 6 mm
QS-8	Push-in connector 8 mm
QS-10	Push-in connector 10 mm
QS-12	Push-in connector 12 mm
PK-3	CK connection 3 mm
PK-4	CK connection 4 mm
PK-6	CK connection 6 mm

004	Adjusting component
	Standard
RS	Knurled screw

005	Flow rate characteristic
	None
LF	Low flow
MF	Medium flow

006	Generation
	None
B	Series B
C	Series C
D	D series

Datasheet

General technical data GRLA – push-in connector QS

Pneumatic connection, port 2	M5	G1/8	G1/4	G3/8	G1/2
Pneumatic connection, port 1	QS-3, QS-4, QS-6	QS-3, QS-4, QS-6, QS-8	QS-6, QS-8, QS-10	QS-12	
Valve function	Exhaust air one-way flow control function	Exhaust air one-way flow control function, One-way flow control function			
Adjustment component	Knurled screw, Slotted head screw				
Type of mounting	Screw-in	Screw-in, Via male thread			
Mounting position	optional				
Nominal torque	0.8 Nm	3 Nm	5 Nm	10 Nm	15 Nm
Tolerance for nominal tightening torque	± 10%				

General technical data GRLZ – push-in connector QS

Pneumatic connection, port 2	M3	M5	G1/8		
Pneumatic connection, port 1	QS-3	QS-3, QS-4, QS-6	QS-3, QS-4, QS-6, QS-8		
Valve function	Supply air one-way flow control function				
Adjustment component	Slotted head screw				
Type of mounting	Screw-in				
Mounting position	optional				
Nominal torque	–	0.8	3		
Tolerance for nominal tightening torque	–	± 10%			

Operating and environmental conditions GRLA/GRLZ – push-in connector QS

Pneumatic connection, port 2	M5	G1/8	G1/4	G3/8	G1/2
Operating pressure	0.2 ... 10 bar				
Operating pressure complete temperature range	0.2 ... 10 bar				
Operating medium	Compressed air to ISO 8573-1:2010 [7:4:4]				
Note on operating and pilot medium	Lubricated operation possible (in which case lubricated operation will always be required)				
Standard nominal flow rate in blocked direction	60 ... 110 l/min	100 ... 500 l/min	290 ... 500 l/min	320 ... 975 l/min	925 ... 1,605 l/min
Standard nominal flow rate in flow control direction	100 ... 115 l/min	130 ... 475 l/min	400 ... 480 l/min	495 ... 900 l/min	1,580 l/min
Standard flow rate in flow control direction 0.6->0 MPa (6->0 bar, 87->0 psi)	135 ... 185 l/min	180 ... 720 l/min	600 ... 760 l/min	740 ... 1,400 l/min	2,220 l/min
Standard flow rate in non-return direction 0.6->0 MPa (6->0 bar, 87->0 psi)	130 ... 200 l/min	180 ... 760 l/min	570 ... 790 l/min	840 ... 1,620 l/min	1,910 ... 2,500 l/min
Ambient temperature	-10 ... 60°C				
Media temperature	-10 ... 60°C				
Storage temperature	–	-10 ... 40°C			
Maritime classification ¹⁾	See certificate				
Corrosion resistance class CRC ²⁾	0 - No corrosion stress, 1 - Low corrosion stress				

1) More information www.festo.com/catalogue/grla → Support/Downloads.

2) More information www.festo.com/x/topic/crc

Materials GRLA/GRLZ – push-in connector QS

Material knurled head	Wrought aluminium alloy, Anodised
Material adjusting screw	Brass, High-alloy stainless steel
Material hollow bolt	Wrought aluminium alloy, Anodised
Material release ring	POM
Material swivel fitting	Die-cast zinc, Chromated
Material screwed plug	Wrought aluminium alloy, Brass
Material seals	NBR
Note on materials	RoHS-compliant
LABS (PWIS) conformity	VDMA24364-B1/B2-L
Cleanroom class	Class 4 according to ISO 14644-1

Datasheet

Standard nominal flow rate q_{nN} at 6 → 5 bar as a function of spindle revolutions n (GRLA/GRLZ-M5 – push-in connector QS, metal)

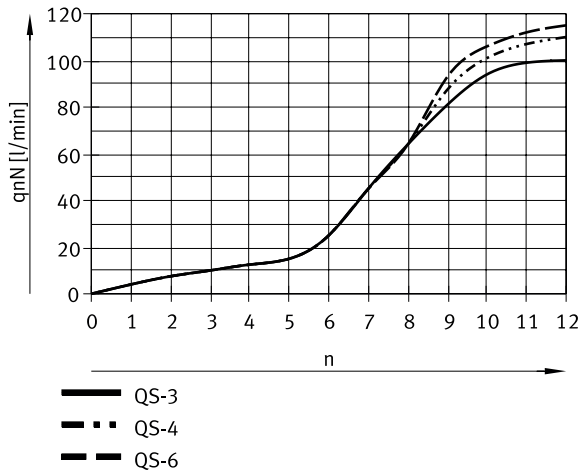

Standard flow rate q_n at 6 → 0 bar as a function of spindle revolutions n (GRLA/GRLZ-M5 – push-in connector QS, metal)

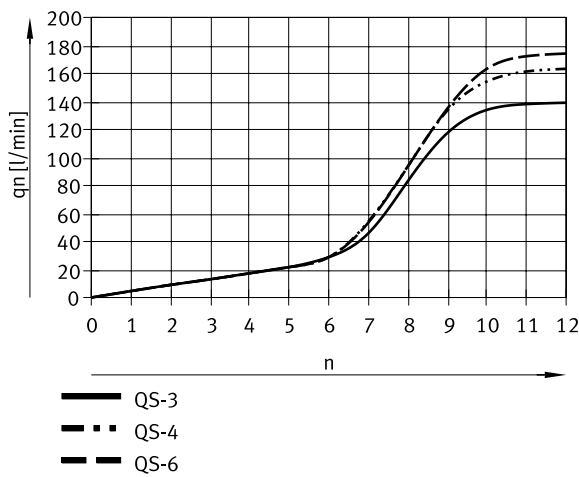

Standard nominal flow rate q_{nN} at 6 → 5 bar as a function of spindle revolutions n (GRLA/GRLZ-1/8 – push-in connector QS, metal)

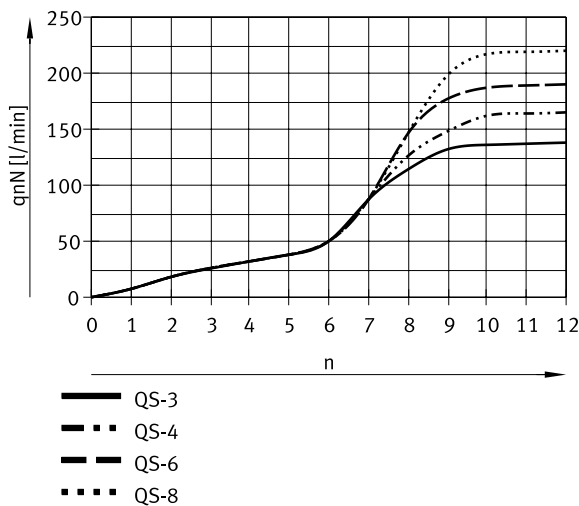

Datasheet

Standard flow rate q_n at 6 → 0 bar as a function of spindle revolutions n (GRLA/GRLZ-1/8 – push-in connector QS, metal)

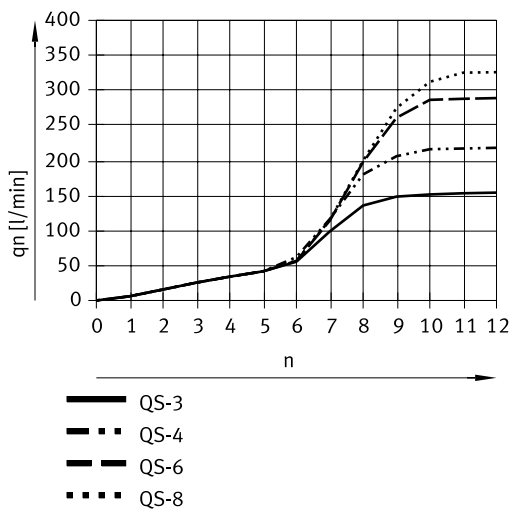

Standard nominal flow rate q_{nN} at 6 → 5 bar as a function of the spindle revolutions n (GRLA-1/8-...-MF, GRLA-1/4 – push-in connector QS, metal)

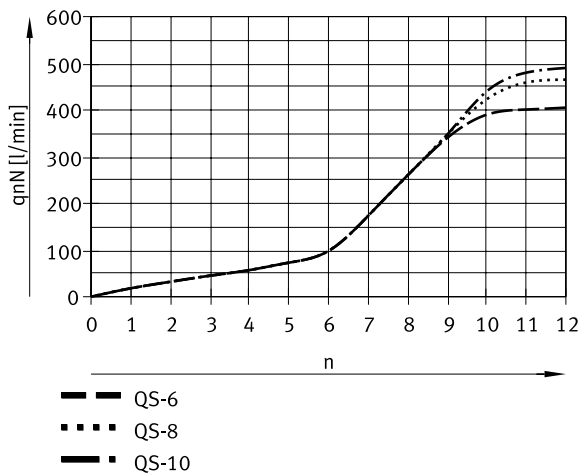

Standard flow rate q_n at 6 → 0 bar as a function of spindle revolutions n (GRLA-1/8-...-MF, GRLA-1/4 – push-in connector QS, metal)

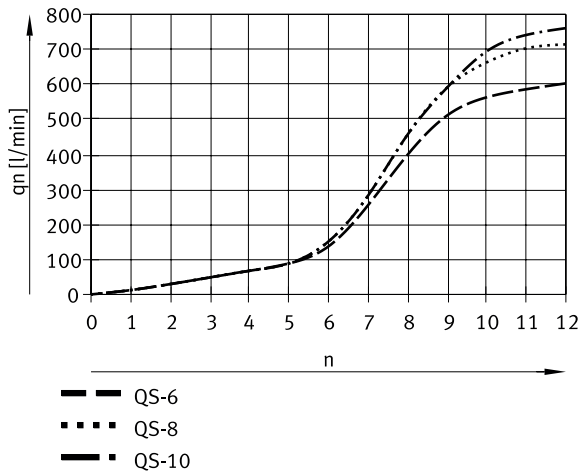

Datasheet

Standard nominal flow rate q_{nN} at 6 → 5 bar as a function of spindle revolutions n (GRLA/GRLZ-3/8 – push-in connector QS, metal)

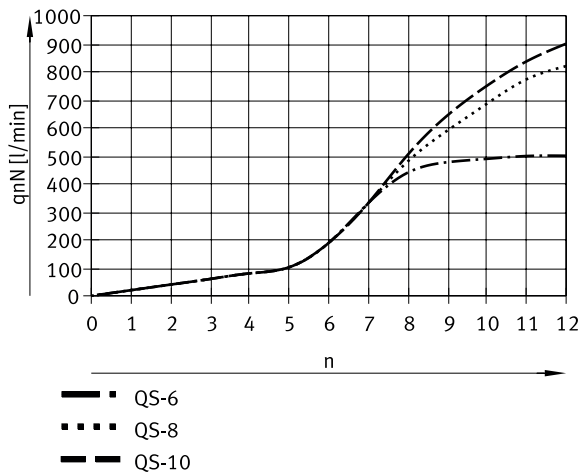

Standard flow rate q_n at 6 → 0 bar as a function of spindle revolutions n (GRLA/GRLZ-3/8 – push-in connector QS, metal)

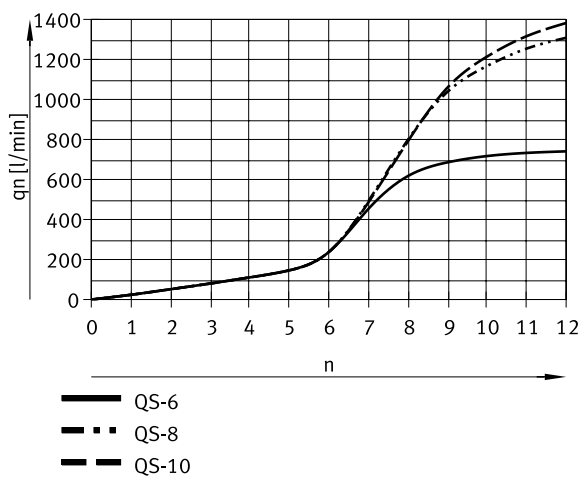

Standard nominal flow rate q_{nN} at 6 → 5 bar as a function of spindle revolutions n (GRLA/GRLZ-1/2 – push-in connector QS, metal)

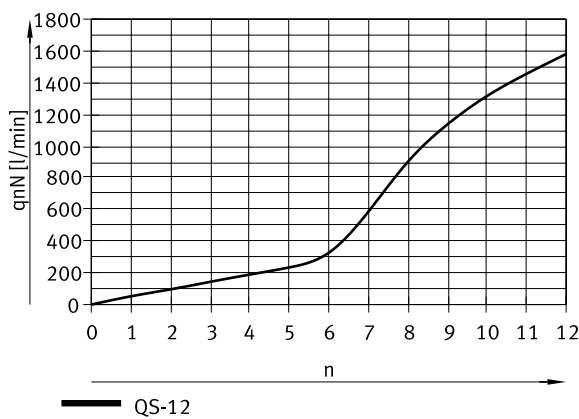

Datasheet

Standard flow rate q_n at 6 → 0 bar as a function of spindle revolutions n (GRLA/GRLZ-1/2 – push-in connector QS, metal)

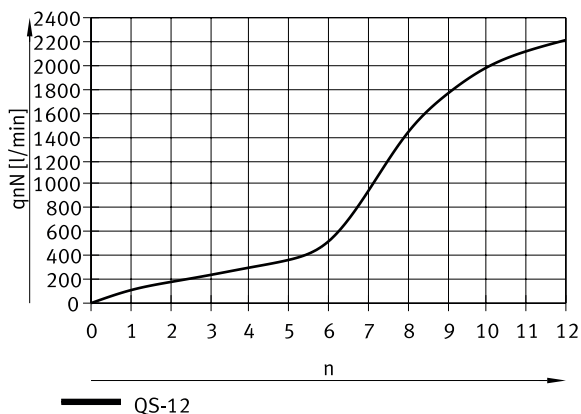

General technical data GRLA – female thread/barbed connector

Pneumatic connection, port 2	Male thread G1/4	M5	G1/8	G3/8	G1/2	G3/4
Pneumatic connection, port 1	Female thread G1/4, For barbed fitting I.D. 4 mm with union nut, For barbed fitting I.D. 6 mm with union nut	M5, PK-3, PK-4	G1/8, PK-3 with union nut, PK-4 with union nut, PK-6 with union nut	G3/8	G1/2	G3/4
Nominal size	6	2	–			
Valve function	Exhaust air one-way flow control function					
Adjustment component	Knurled screw, Slotted head screw			Slotted head screw		
Type of mounting	Screw-in					
Mounting position	optional					
Max. tightening torque	11	1.5	6	20	40	60

General technical data GRLZ – female thread/barbed connector

Pneumatic connection, port 2	Male thread G1/4	M5	G1/8
Pneumatic connection, port 1	Female thread G1/4	M5	G1/8
Nominal size	6	2	–
Valve function	Supply air one-way flow control function		
Adjustment component	Knurled screw, Slotted head screw		
Type of mounting	Screw-in		
Mounting position	optional		
Max. tightening torque	11 Nm	1.5 Nm	6 Nm

Datasheet

Operating and ambient conditions GRLA/GRLZ – female thread/barbed connector

Pneumatic connection, port 2	Male thread G1/4	M5	G1/8	G3/8	G1/2	G3/4
Operating pressure	–	0.2 ... 10 bar	–	–	0.3 ... 10 bar	–
Operating pressure complete temperature range	0.3 ... 10 bar	–	0.3 ... 10 bar	–	–	0.3 ... 10 bar
Operating medium	Compressed air to ISO 8573-1:2010 [7:4:4]					
Standard nominal flow rate in blocked direction	220 ... 820 l/min	72 ... 95 l/min	100 ... 420 l/min	970 ... 1,600 l/min	1,550 ... 2,200 l/min	3,220 ... 4,320 l/min
Standard nominal flow rate in flow control direction	260 ... 610 l/min	83 ... 95 l/min	110 ... 340 l/min	1,450 l/min	2,100 l/min	4,320 l/min
Standard flow rate in non-return direction 0.6->0 MPa (6->0 bar, 87->0 psi)	315 ... 1,615 l/min	120 ... 170 l/min	145 ... 760 l/min	1,540 ... 2,540 l/min	2,950 ... 4,190 l/min	5,440 ... 7,300 l/min
Standard flow rate in flow control direction 0.6->0 MPa (6->0 bar, 87->0 psi)	370 ... 1,200 l/min	140 ... 169 l/min	162 ... 615 l/min	2,300 l/min	4,000 l/min	7,300 l/min
Note on operating and pilot medium	Lubricated operation possible (in which case lubricated operation will always be required)					
Ambient temperature	-10 ... 60°C					
Media temperature	-10 ... 60°C					
Maritime classification ¹⁾	See certificate					
Corrosion resistance class CRC ²⁾	2 - Moderate corrosion stress	–				

1) GRLA only; more information www.festo.com/catalogue/grla → Support/Downloads.

2) More information www.festo.com/x/topic/crc

Materials GRLA/GRLZ – female thread/barbed connector

Material adjusting screw	Brass
Material swivel fitting	Die-cast zinc
Material screwed plug	Wrought aluminium alloy, Brass, Nickel-plated
Material seals	NBR
Note on materials	RoHS-compliant
LABS (PWIS) conformity	VDMA24364-B1/B2-L
Cleanroom class	Class 4 according to ISO 14644-1

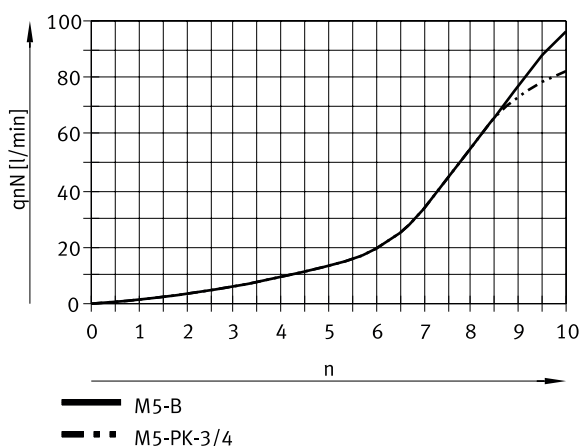
Standard nominal flow rate q_{nN} at 6 → 5 bar as a function of spindle revolutions n (GRLA/GRLZ-M5 – female thread/barbed connector, metal)

Datasheet

Standard flow rate q_n at 6 → 0 bar as a function of spindle revolutions n (GRLA/GRLZ-M5 – female thread/barbed connector, metal)

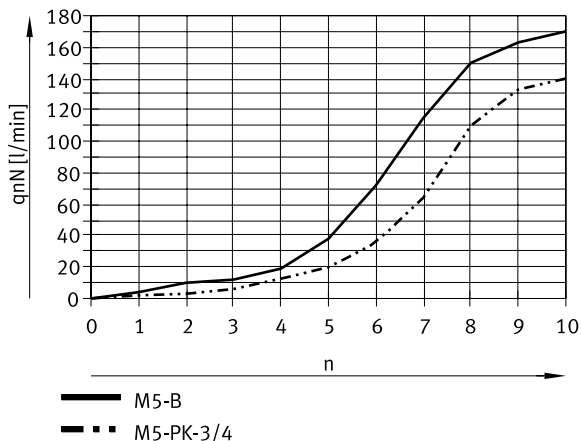

Standard nominal flow rate q_n at 6 → 5 bar as a function of spindle revolutions n (GRLA/GRLZ-1/8 – female thread/barbed connector, metal)

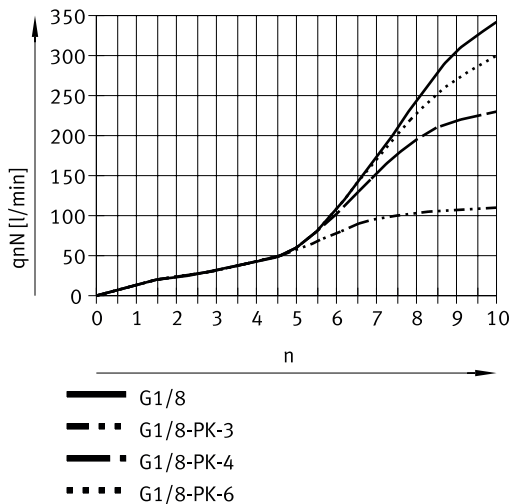

Standard flow rate q_n at 6 → 0 bar as a function of spindle revolutions n (GRLA/GRLZ-1/8 – female thread/barbed connector, metal)

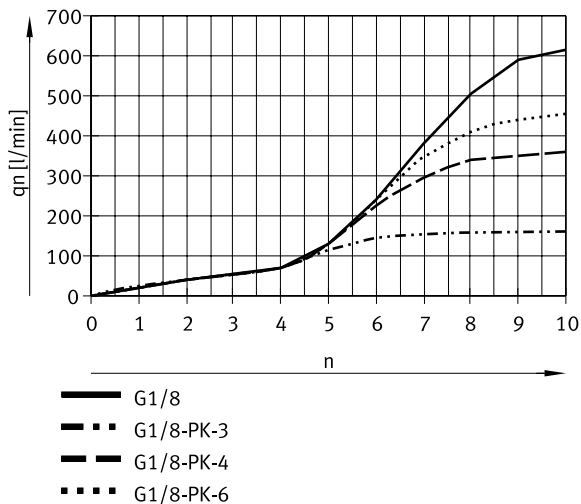

Datasheet

Standard nominal flow rate q_{nN} at 6 → 5 bar as a function of spindle revolutions n (GRLA/GRLZ-1/4 – female thread/barbed connector, metal)

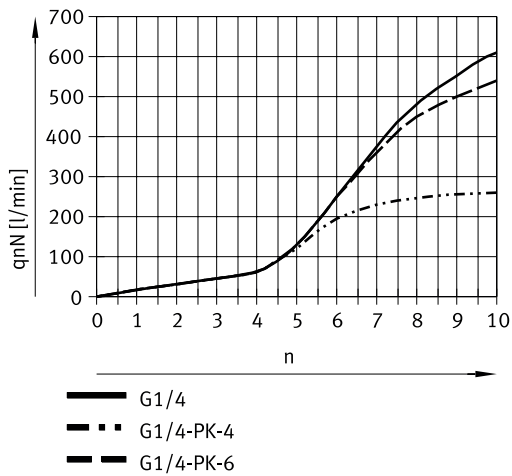

Standard flow rate q_n at 6 → 0 bar as a function of spindle revolutions n (GRLA/GRLZ-1/4 – female thread/barbed connector, metal)

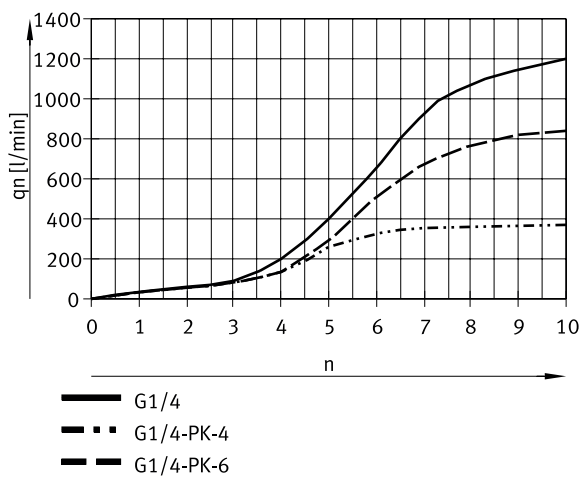

Standard nominal flow rate q_{nN} at 6 → 5 bar as a function of spindle revolutions n (GRLA/GRLZ-3/8 – female thread/barbed connector, metal)

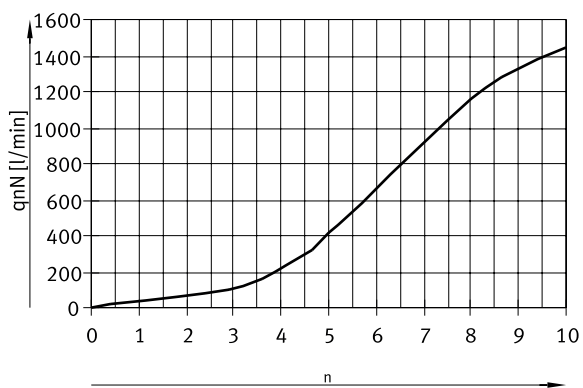

Datasheet

Standard flow rate q_n at 6 → 0 bar as a function of spindle revolutions n (GRLA/GRLZ-3/8 – female thread/barbed connector, metal)

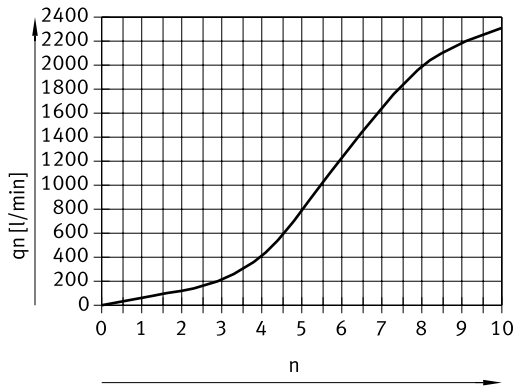

Standard nominal flow rate q_{nN} at 6 → 5 bar as a function of spindle revolutions n (GRLA/GRLZ-1/2 – female thread/barbed connector, metal)

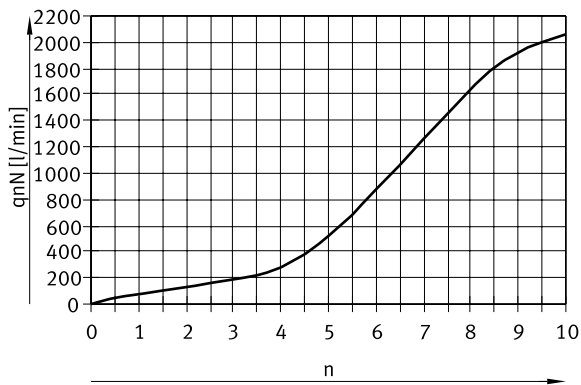

Standard flow rate q_n at 6 → 0 bar as a function of spindle revolutions n (GRLA/GRLZ-1/2 – female thread/barbed connector, metal)

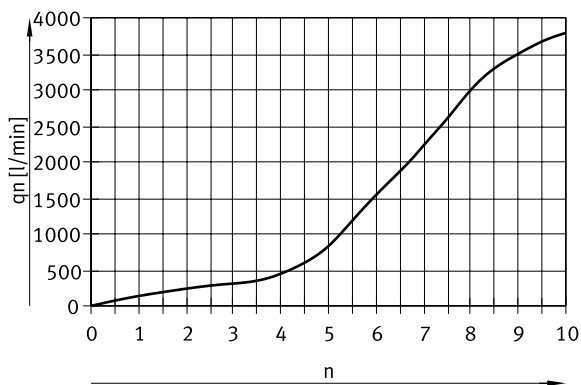

Datasheet

Standard nominal flow rate q_{nN} at 6 → 5 bar as a function of spindle revolutions n (GRLA/GRLZ-3/4 – female thread/barbed connector, metal)

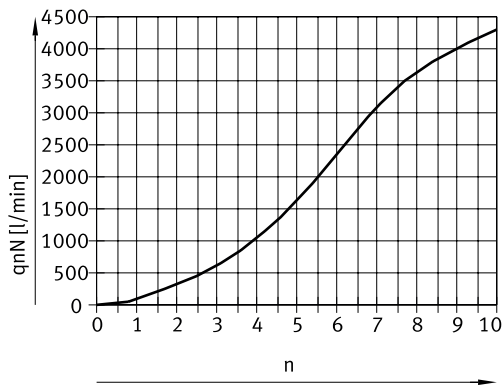

Standard flow rate q_n at 6 → 0 bar as a function of spindle revolutions n (GRLA/GRLZ-3/4 – female thread/barbed connector, metal)

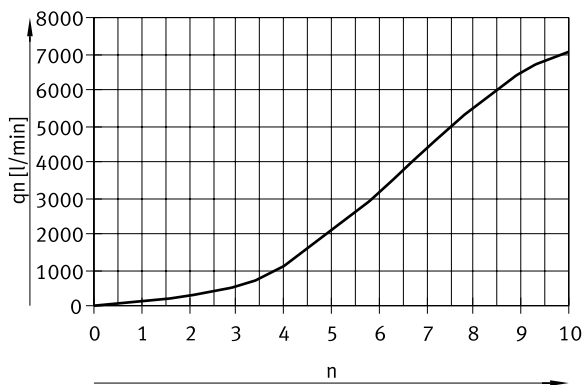

General technical data GRLSA – push-in connector QS

Pneumatic connection, port 2	G1/8	G1/4
Pneumatic connection, port 1	QS-6	QS-8
Valve function	Exhaust air one-way flow control function	
Adjustment component	Internal hexagon	
Type of mounting	Screw-in	
Mounting position	optional	
Nominal torque	3.5	11
Tolerance for nominal tightening torque	± 20%	± 10%

Datasheet

Operating and ambient conditions GRLSA – push-in connector QS

Pneumatic connection, port 2	G1/8	G1/4
Operating pressure complete temperature range	0.2 ... 10 bar	
Operating medium	Compressed air to ISO 8573-1:2010 [7:4:4]	
Standard nominal flow rate in flow control direction	0 ... 250 l/min	0 ... 450 l/min
Standard nominal flow rate in blocked direction	180 ... 310 l/min	390 ... 570 l/min
Standard flow rate in flow control direction 0.6->0 MPa (6->0 bar, 87->0 psi)	0 ... 410 l/min	0 ... 700 l/min
Standard flow rate in non-return direction 0.6->0 MPa (6->0 bar, 87->0 psi)	430 ... 540 l/min	820 ... 930 l/min
Note on operating and pilot medium	Lubricated operation possible (in which case lubricated operation will always be required)	
Ambient temperature	-10 ... 60°C	
Media temperature	-10 ... 60°C	
Storage temperature	-10 ... 40°C	
Corrosion resistance class CRC ¹⁾	1 - Low corrosion stress	

1) More information www.festo.com/x/topic/crc

Materials GRLSA – push-in connector QS

Material adjusting screw	PA-reinforced
Material swivel fitting	Die-cast zinc
Material release ring	POM
Material hollow bolt	Wrought aluminium alloy, Anodised
Material seals	NBR
LABS (PWIS) conformity	VDMA24364-B2-L
Cleanroom class	Class 4 according to ISO 14644-1

Standard nominal flow rate q_{nN} at 6 → 5 bar as a function of the flow control screw position (scale) n (GRLSA-1/8 – push-in connector QS, metal)

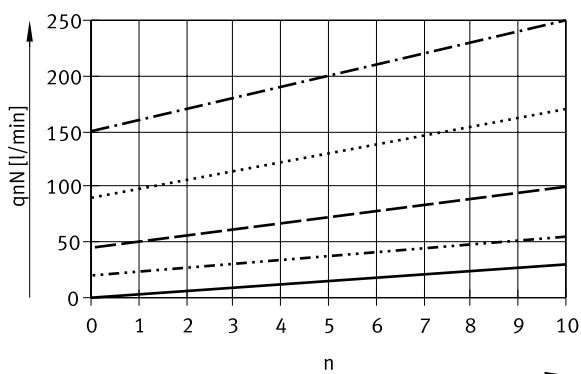

A = Step A
 B = Step B
 C = Step C
 D = Step D
 E = Step E

- A
- B
- - - C
- · - · D
- - - - E

Datasheet

Standard flow rate q_n at 6 → 0 bar as a function of the flow control screw position (scale) n (GRLSA-1/8 - push-in connector QS, metal)

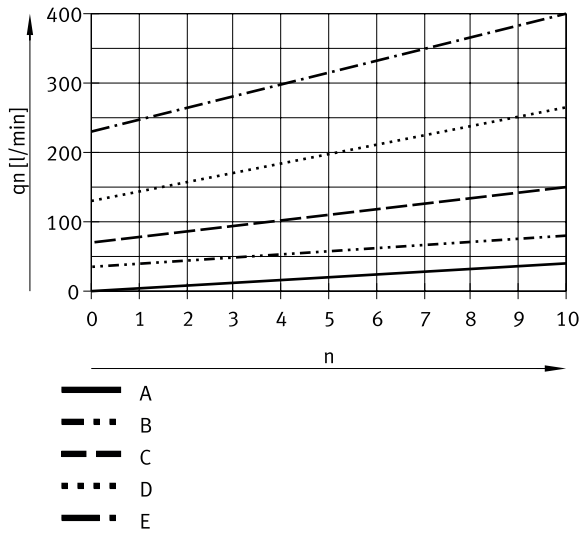

- A = Step A
- B = Step B
- C = Step C
- D = Step D
- E = Step E

Standard nominal flow rate q_{nN} at 6 → 5 bar as a function of the flow control screw position (scale) n (GRLSA-1/4 – push-in connector QS, metal)

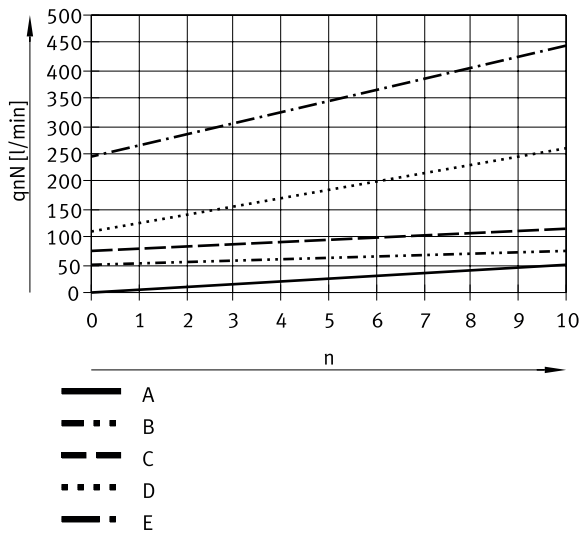

- A = Step A
- B = Step B
- C = Step C
- D = Step D
- E = Step E

Standard flow rate q_n at 6 → 0 bar as a function of the flow control screw position (scale) n (GRLSA-1/4 – push-in connector QS, metal)

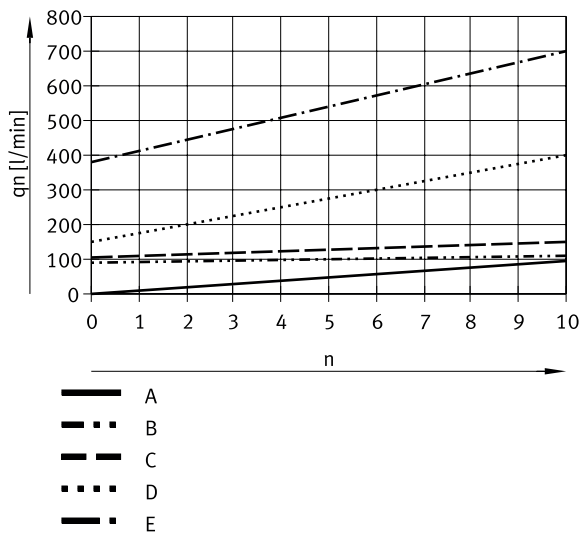

- A = Step A
- B = Step B
- C = Step C
- D = Step D
- E = Step E

Datasheet

General technical data GRLA – push-in connector QS (Mini)

Pneumatic connection, port 2	M3	M5
Pneumatic connection, port 1	QS-3	QS-3, QS-4
Valve function	Exhaust air one-way flow control function	
Adjustment component	Slotted head screw	
Type of mounting	Screw-in	
Mounting position	optional	
Max. tightening torque	0.3 Nm	1.5 Nm

General technical data GRLZ – push-in connector QS (Mini)

Pneumatic connection, port 2	M3	M5
Pneumatic connection, port 1	QS-3	QS-3, QS-4
Valve function	Supply air one-way flow control function	
Adjustment component	Slotted head screw	
Type of mounting	Screw-in	
Mounting position	optional	
Max. tightening torque	0.3 Nm	1.5 Nm

Operating and environmental conditions GRLA/GRLZ – push-in connector QS (Mini)

Pneumatic connection, port 2	M3	M5
Operating pressure	0.2 ... 10 bar	
Operating pressure	–	2.9 ... 145 psi
Operating medium	Compressed air to ISO 8573-1:2010 [7:4:4]	
Note on operating and pilot medium	Lubricated operation possible (in which case lubricated operation will always be required)	
Standard nominal flow rate in flow control direction	41 l/min	40 ... 48 l/min
Standard nominal flow rate in blocked direction	27 ... 50 l/min	36 ... 75 l/min
Standard flow rate in non-return direction 0.6->0 MPa (6->0 bar, 87->0 psi)	75 ... 110 l/min	60 ... 150 l/min
Standard flow rate in flow control direction 0.6->0 MPa (6->0 bar, 87->0 psi)	95 l/min	80 l/min
Ambient temperature	-10 ... 60°C	
Media temperature	-10 ... 60°C	
Maritime classification ¹⁾	See certificate	
Corrosion resistance class CRC ²⁾	1 - Low corrosion stress	

1) GRLA only: more information www.festo.com/catalogue/grla → Support/Downloads.

2) More information www.festo.com/x/topic/crc

Materials GRLA/GRLZ – push-in connector QS (Mini)

Material adjusting screw	Brass
Material swivel fitting	Die-cast zinc
Material release ring	POM
Material screwed plug	Brass, Nickel-plated
Material seals	NBR
Note on materials	RoHS-compliant
LABS (PWIS) conformity	VDMA24364-B1/B2-L
Cleanroom class	Class 4 according to ISO 14644-1

Datasheet

Standard nominal flow rate q_{nN} at 6 → 5 bar as a function of spindle revolutions n (GRLA/GRLZ-M3, mini – push-in connector QS, metal)

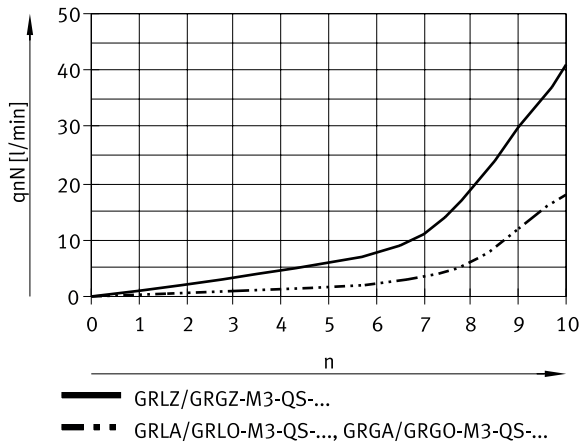

Standard flow rate q_n at 6 → 0 bar as a function of spindle revolutions n (GRLA/GRLZ-M3, mini – push-in connector QS, metal)

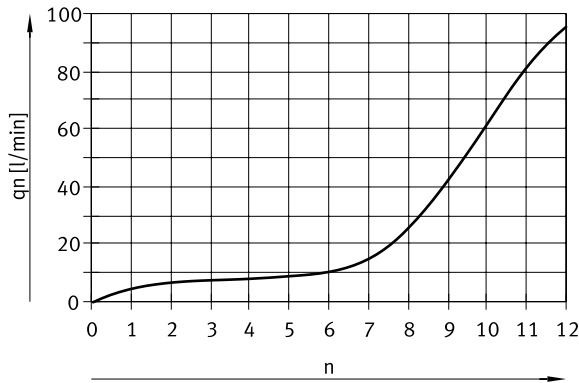

Standard nominal flow rate q_{nN} at 6 → 5 bar as a function of spindle revolutions n (GRLA/GRLZ-M5, mini – push-in connector QS, metal)

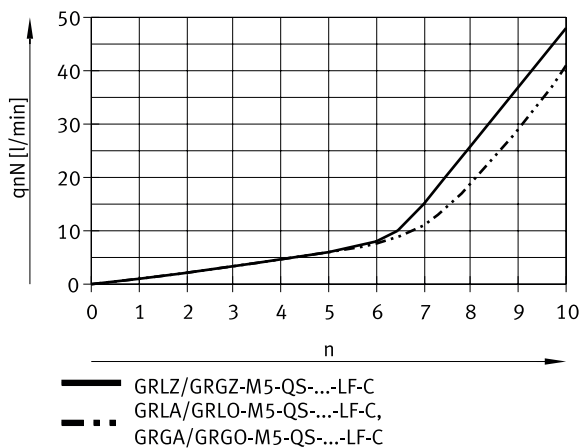

Datasheet

Standard flow rate q_n at 6 → 0 bar as a function of spindle revolutions n (GRLA/GRLZ-M5, mini – push-in connector QS, metal)

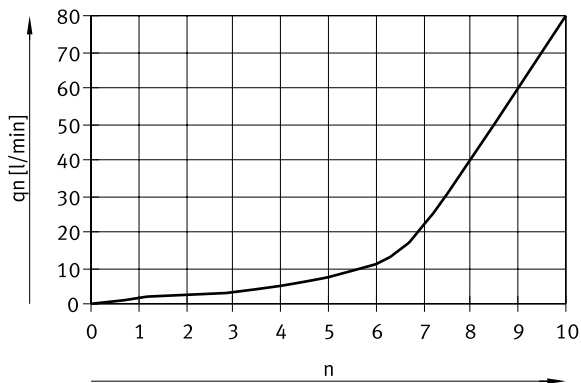

General technical data GRLA – female thread (Mini)

Pneumatic connection, port 2	M3
Pneumatic connection, port 1	M3
Valve function	Exhaust air one-way flow control function
Adjustment component	Slotted head screw
Type of mounting	Screw-in
Mounting position	optional
Max. tightening torque	0.3 Nm

General technical data GRLZ – female thread (Mini)

Pneumatic connection, port 2	M3
Pneumatic connection, port 1	M3
Valve function	Supply air one-way flow control function
Adjustment component	Slotted head screw
Type of mounting	Screw-in
Mounting position	optional
Max. tightening torque	0.3 Nm

Operating and environmental conditions GRLA/GRLZ – female thread (Mini)

Operating pressure	0.2 ... 10 bar
Operating medium	Compressed air to ISO 8573-1:2010 [7:4:4]
Note on operating and pilot medium	Lubricated operation possible (in which case lubricated operation will always be required)
Standard nominal flow rate in flow control direction	18 l/min
Standard nominal flow rate in blocked direction	18 ... 20 l/min
Standard flow rate in flow control direction 0.6->0 MPa (6->0 bar, 87->0 psi)	33 l/min
Standard flow rate in non-return direction 0.6->0 MPa (6->0 bar, 87->0 psi)	33 ... 37 l/min
Ambient temperature	-10 ... 60°C
Media temperature	-10 ... 60°C
Maritime classification ¹⁾	See certificate
Corrosion resistance class CRC ²⁾	1 - Low corrosion stress

1) GRLA only: more information www.festo.com/catalogue/grla → Support/Downloads.

2) More information www.festo.com/x/topic/crc

Datasheet

Materials GRLA/GRLZ – female thread (Mini)

Material adjusting screw	Brass
Material swivel fitting	Die-cast zinc
Material screwed plug	Brass, Nickel-plated
Material seals	NBR
Note on materials	RoHS-compliant
LABS (PWIS) conformity	VDMA24364-B1/B2-L
Cleanroom class	Class 4 according to ISO 14644-1

Standard nominal flow rate q_{nN} at 6 → 5 bar as a function of spindle revolutions n (GRLA/GRLZ, mini – female thread, metal)

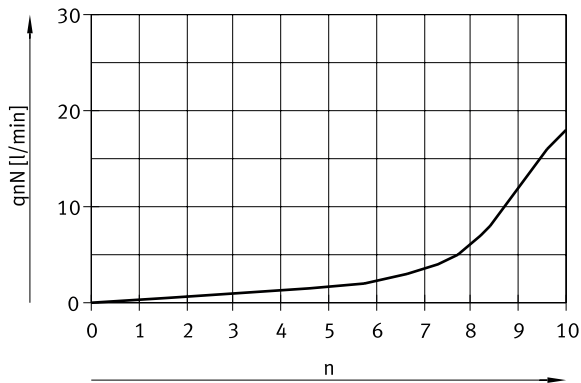

Standard flow rate q_n at 6 → 0 bar as a function of spindle revolutions n (GRLA/GRLZ, mini – female thread, metal)

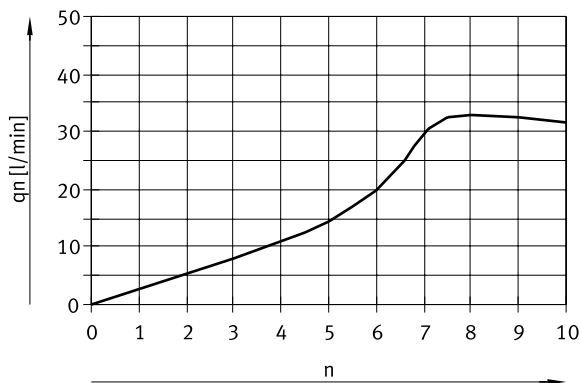

General technical data CRGRLA – female thread (stainless steel)

Pneumatic connection, port 2	M5	G1/8	G1/4	G3/8	G1/2
Pneumatic connection, port 1	M5	G1/8	G1/4	G3/8	G1/2
Valve function	One-way flow control function				
Adjustment component	Slotted head screw				
Type of mounting	Screw-in				
Mounting position	optional				
Max. tightening torque	1.5 Nm	6 Nm	11 Nm	20 Nm	40 Nm
Permissible actuation moment, regulating screw	0.2 Nm	0.5 Nm	1.5 Nm	2 Nm	3 Nm

Datasheet

Operating and environmental conditions CRGRLA – female thread (stainless steel)

Pneumatic connection, port 2	M5	G1/8	G1/4	G3/8	G1/2
Operating pressure	0.02 ... 1 MPa		0.03 ... 1 MPa		
Operating pressure	0.2 ... 10 bar		0.3 ... 10 bar		
Operating pressure	2.9 ... 145 psi		4.35 ... 145 psi		
Operating medium	Compressed air to ISO 8573-1:2010 [7:4:4]				
Note on operating and pilot medium	Lubricated operation possible (in which case lubricated operation will always be required)				
Standard nominal flow rate in blocked direction	77 ... 95 l/min	260 ... 420 l/min	450 ... 820 l/min	970 ... 1,600 l/min	1,550 ... 2,200 l/min
Standard nominal flow rate in flow control direction	95 l/min	340 l/min	610 l/min	1,450 l/min	2,100 l/min
Standard flow rate in non-return direction 0.6->0 MPa (6->0 bar, 87->0 psi)	140 ... 150 l/min	530 ... 590 l/min	1,030 ... 1,345 l/min	2,095 ... 2,665 l/min	3,550 ... 4,325 l/min
Standard flow rate in flow control direction 0.6->0 MPa (6->0 bar, 87->0 psi)	165 l/min	580 l/min	1,265 l/min	2,515 l/min	4,265 l/min
Ambient temperature	-20 ... 80°C				
Media temperature	-10 ... 60°C				
Storage temperature	-10 ... 40°C				
Corrosion resistance class CRC ¹⁾	3 - high corrosion stress				
Suitable for use with food	See supplementary material information				
Maritime classification ²⁾	See certificate				

1) More information www.festo.com/x/topic/crc

2) More information www.festo.com/catalogue/crgla → Support/Downloads.

Materials CRGRLA – female thread (stainless steel)

Material adjusting screw	High-alloy stainless steel
Material swivel fitting	High-alloy stainless steel
Material hollow bolt	High-alloy steel
Material seals	FPM, PVC
Note on materials	RoHS-compliant
LABS (PWIS) conformity	VDMA24364-B2-L
Cleanroom class	Class 4 according to ISO 14644-1

Standard nominal flow rate q_{nN} at 6 → 5 bar as a function of spindle revolutions n (CRGRLA-M5, CRGRLA-1/8 – female thread, stainless steel)

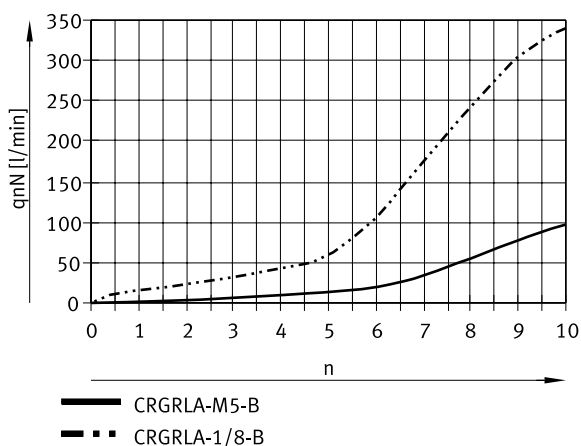

Datasheet

Standard flow rate q_n at 6 → 0 bar as a function of spindle revolutions n (CRGRLA-M5, CRGRLA-1/8 – female thread, stainless steel)

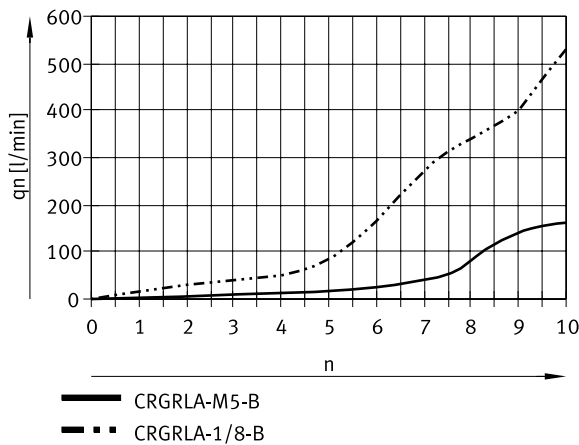

Standard nominal flow rate q_{nN} at 6 → 5 bar as a function of spindle revolutions n (CRGRLA-1/4, CRGRLA-3/8, CRGRLA-1/2 – female thread, stainless steel)

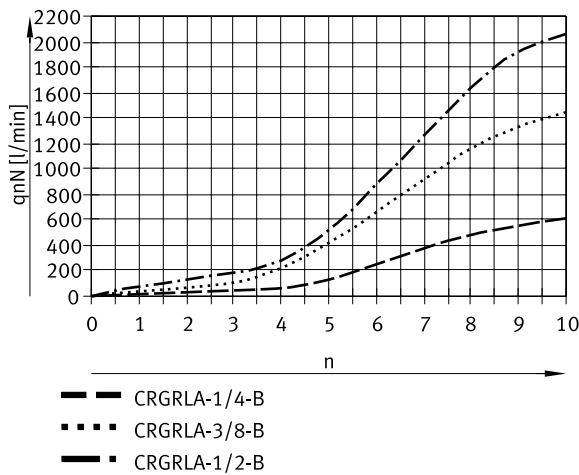

Standard flow rate q_n at 6 → 0 bar as a function of spindle revolutions n (CRGRLA-1/4, CRGRLA-3/8, CRGRLA-1/2 - female thread, stainless steel)

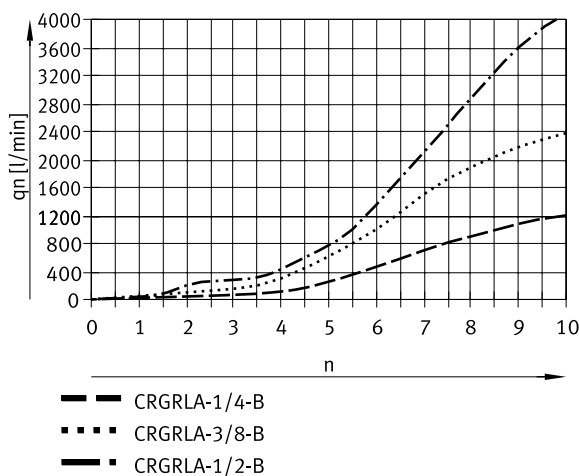

Dimensions

Dimensions – Slotted head screw

Download CAD data → www.festo.com

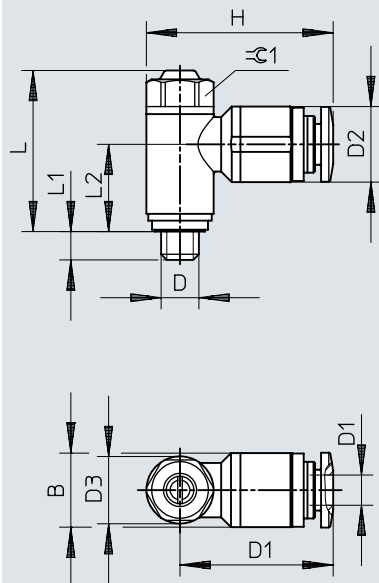

	D	D1	B	D2 ø	D3 ø	~H	~H1	~L	L1	~L2	⊖C	
GRL...-M5	M5	3	–	8,2 +0,15	8,9 ±0,07	22,4	18	20,8	±3,3%	3,9 +0,1/-0,45	10,7	8
		4	9,8 ±0,2	10,0 ±0,2		24,7	20,3				9,7	
		6	–	12,0 ±0,2		26,5	22					
GRL...-1/8	G1/8	3	–	10,2 ±0,2	13,8 ±0,07	31,9	25	26,5	±2,1%	5,05 +0,15/-0,3	14,2	12
		4		10,2 ±0,2		29,4	22,5				13,5	
		6		12,5 ±0,2		32,6	25,7					
		8		14,5 ±0,2		35,6	28,7					
GRLA-1/8-...-MF	G1/8	6	–	12,5 ±0,2	17,8 ±0,15	36,6	27,7	30,9	±1,9%	5,05 +0,15/-0,3	17	15
		8		14,5 ±0,2		39,6	30,7					
GRLA-1/4	G1/4	6	–	12,5 ±0,2	17,8 ±0,15	36,6	27,7	31,5	±1,9%	5,9 +0,17/-0,25	17,2	15
		8		14,5 ±0,2		39,6	30,7				16,1	
		10		17,5 ±0,2		42,0	33,1					
GRLA-3/8	G3/8	6	–	12,5 ±0,2	22,4 ±0,15	39,8	28,6	35,3	±1,7%	6,9 +0,15/-0,3	19,55	19
		8		14,5 ±0,2		44,1	32,9					
		10		17,5 ±0,2		46,7	35,5					
GRLA-1/2	G1/2	12	–	20,5 ±0,15	27,8 ±0,15	55,3	41,4	42,6	±1,4%	8,35 +0,15/-0,3	22,75	24

Dimensions

Dimensions – Knurled screw

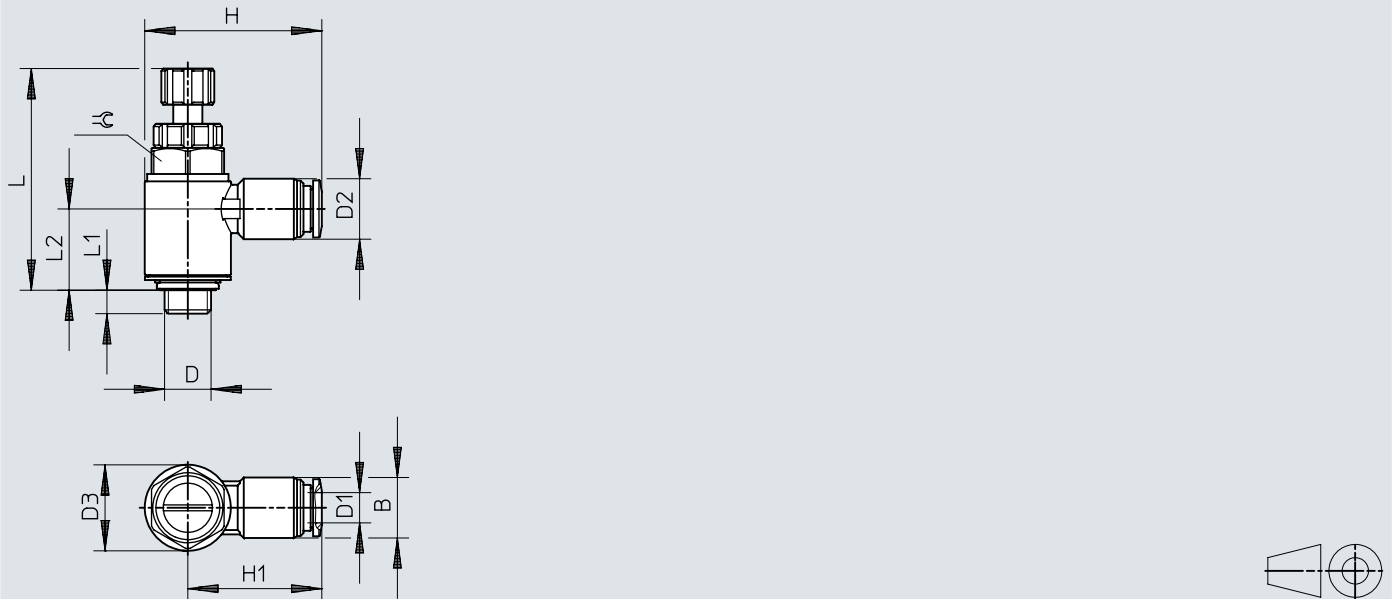
Download CAD data → www.festo.com

	D	D1	B	D2 ø	D3 ø	~H	~H1	~L	L1	~L2	≙	
GRL...-M5	M5	3	–	8,2 +0,15	8,9 ±0,07	22,4	18	31,5	±2,4%	3,9 +0,1/-0,45	10,7	8
		4	9,8 ±0,2	10,0 ±0,2		24,7	20,3				9,7	
		6	–	12,0 ±0,2		26,5	22				–	
GRL...-1/8	G1/8	3	–	10,2 ±0,2	13,8 ±0,07	31,9	25	40,4	±1,6%	5,05 +0,15/-0,3	14,2	12
		4		10,2 ±0,2		29,4	22,5				–	
		6		12,5 ±0,2		32,6	25,7				13,5	
		8		14,5 ±0,2		35,6	28,7				–	
GRLA-1/8-...-MF	G1/8	6	–	12,5 ±0,2	17,8 ±0,15	36,6	27,7	–	–	5,05 +0,15/-0,3	17	15
		8		14,5 ±0,2		39,6	30,7				–	
GRLA-1/4	G1/4	6	–	12,5 ±0,2	17,8 ±0,15	36,6	27,7	48,5	±1,4%	5,9 +0,17/-0,25	17,2	15
		8		14,5 ±0,2		39,6	30,7				16,1	
		10		17,5 ±0,2		42,0	33,1				–	
GRLA-3/8	G3/8	6	–	12,5 ±0,2	22,4 ±0,15	39,8	28,6	55	±1,3%	6,9 +0,15/-0,3	19,55	19
		8		14,5 ±0,2		44,1	32,9				–	
		10		17,5 ±0,2		46,7	35,5				–	
GRLA-1/2	G1/2	12	–	20,5 ±0,15	27,8 ±0,15	55,3	41,4	65,9	±1,1%	8,35 +0,15/-0,3	22,75	24

Dimensions

Dimensions – Connection type female thread slotted screw

Download CAD data → www.festo.com

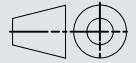
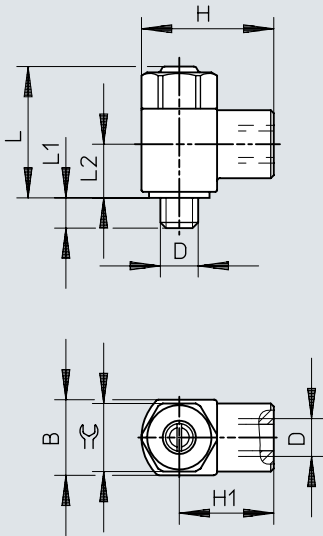

	D	B	~H	~H1	~L		L1	~L2	≈C
GRL...-M5	M5	10 ^{-0,15}	17,5	12,5	18	±6,2%	4,0 ±0,3	7,1	9
GRL...-1/8	G1/8	16 ^{-0,15}	28	20	26	±3,9%	5,3 ^{+0,45/-0,35}	10,3	14
GRL...-1/4	G1/4	20 ^{-0,2}	36	26	31,7	±3,2%	8,2 ^{+0,45/-0,35}	13,2	17
GRLA-3/8	G3/8	25 ^{-0,2}	41	28,5	38,5	±2,9%	8,8 ^{+0,45/-0,35}	15,5	22
GRLA-1/2	G1/2	32 ^{-0,2}	53	37	50	±2,4%	12,8 ±0,45	18,9	27
GRLA-3/4	G3/4	41 ^{-0,3}	64	43,5	61,8	±2,2%	13,5 ±0,5	24,5	36

Dimensions

Dimensions – Connection type female thread knurled screw

Download CAD data → www.festo.com

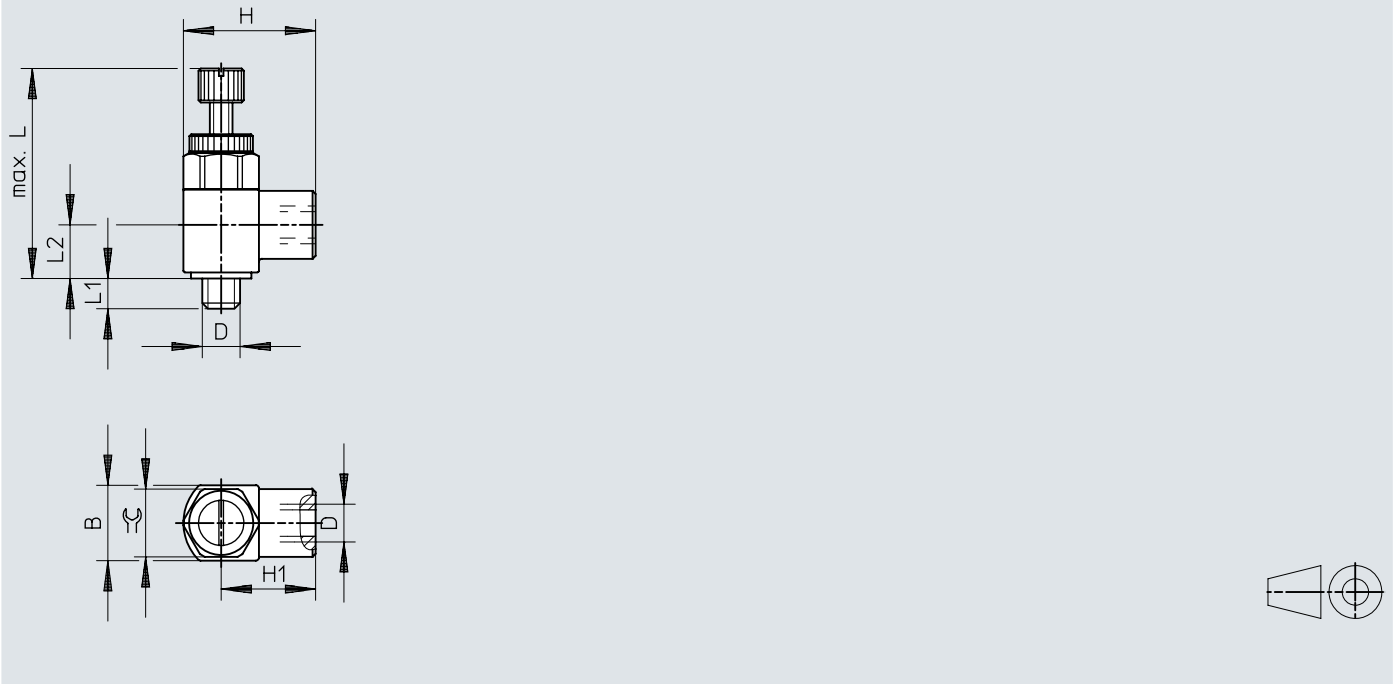

	D	B	~H	~H1	~L	L1	~L2	≙
GRL...-M5	M5	10 ^{-0,15}	17,5	12,5	28	±3,4%	4,0 ±0,3	9
GRL...-1/8	G1/8	16 ^{-0,15}	28	20	39,4	±2,1%	5,3 ^{+0,45/-0,35}	14
GRL...-1/4	G1/4	20 ^{-0,2}	36	26	47,4	±2,0%	8,2 ^{+0,45/-0,35}	17
GRLA-3/8	G3/8	25 ^{-0,2}	41	28,5	-		8,8 ^{+0,45/-0,35}	22
GRLA-1/2	G1/2	32 ^{-0,2}	53	37	-		12,8 ±0,45	27
GRLA-3/4	G3/4	41 ^{-0,3}	64	43,5	-		13,5 ±0,5	36

Dimensions

Dimensions – Connection type barbed connector GRL...-M5

Download CAD data → www.festo.com

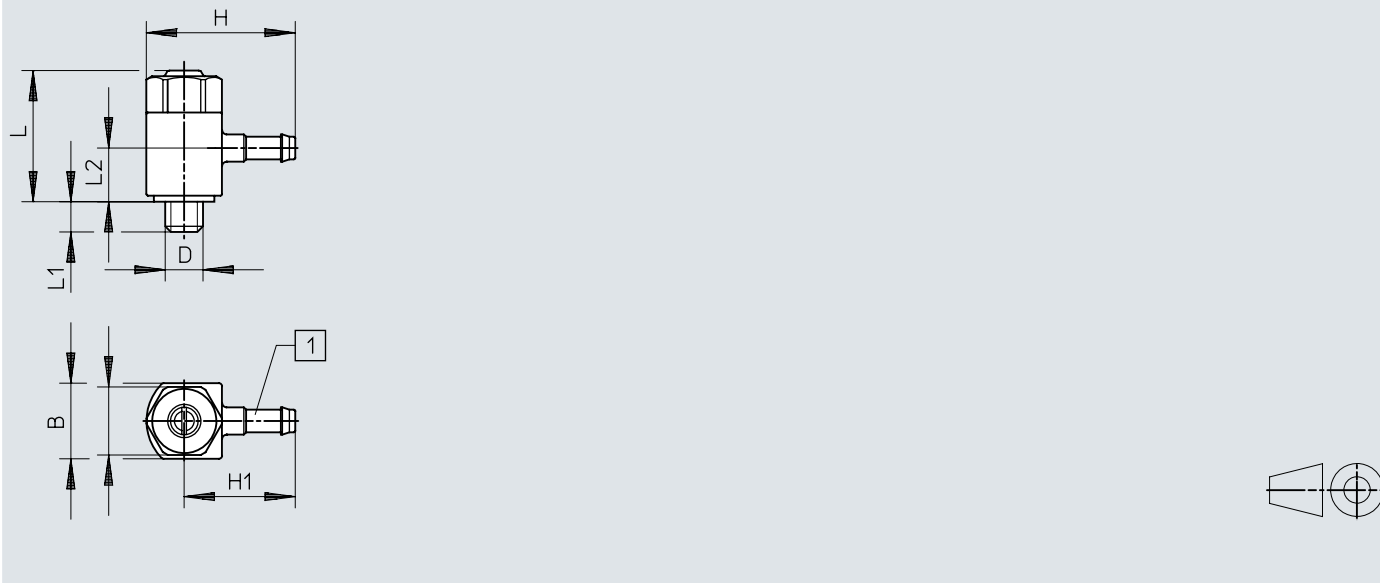

	D	B	~H	~H1	~L	L1	~L2	≙	
GRL...-M5-PK-3	M5	10 -0,15	19,7	14,7	18	±5,7%	4,0 ±0,3	8,5	9
GRL...-M5-PK-4		10 -0,15	21,7	16,7	18	±5,7%	4,0 ±0,3	8,5	9

Dimensions

Dimensions – Connection type barbed connector GRL...-1/8, GRL...-1/4

Download CAD data → www.festo.com

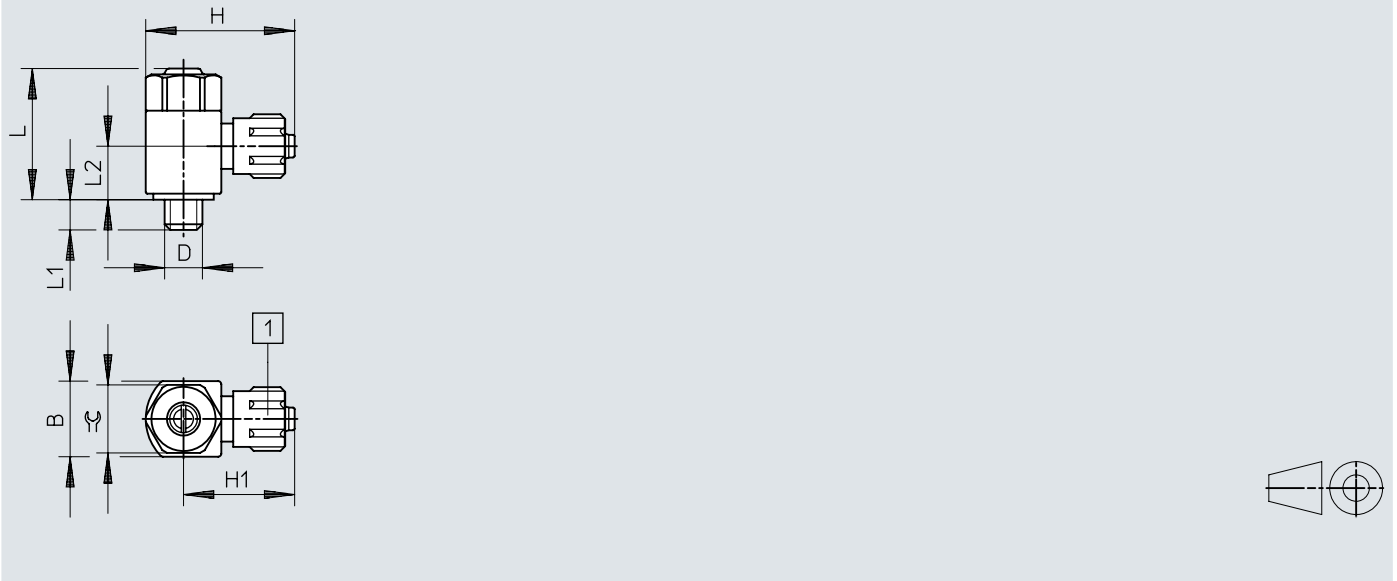

	D	B	~H	~H1	~L	L1	~L2	≡C
GRL...-1/8-PK-3	G1/8	16 -0,15	27,1	19,1	26 ±3,9%	5,3 +0,45/-0,35	13,4	14
GRL...-1/8-PK-4		16 -0,15	30,2	22,2	26 ±3,9%	5,3 +0,45/-0,35	13,4	14
GRL...-1/8-PK-6		16 -0,15	30,3	22,3	26 ±3,9%	5,3 +0,45/-0,35	12,0	14
GRL...-1/4-PK-4	G1/4	20 -0,2	34,2	24,2	31,7 ±3,3%	8,2 +0,45/-0,35	16,9	17
GRL...-1/4-PK-6		20 -0,2	34,3	24,3	31,7 ±3,3%	8,2 +0,45/-0,35	17,2	17

Dimensions

Dimensions – One-way flow control valves GRLSA, standard

Download CAD data → www.festo.com

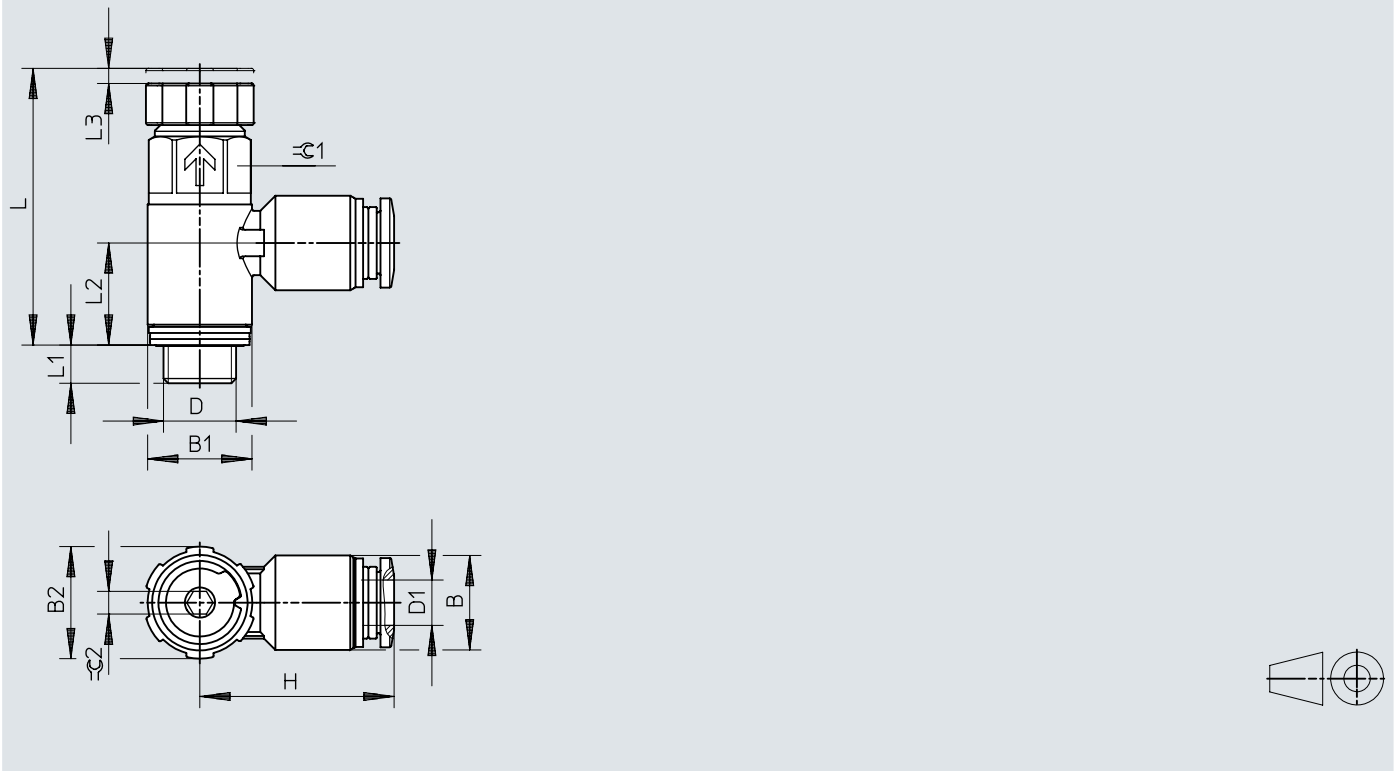

	D	B	B1	B2	H	L	L1	L2	L3	⊥C1	⊥C2
GRLSA-1/8	G1/8	12,5	13,8	15	25,7	36,6	5,1	13,5	2	12	3
GRLSA-1/4	G1/4	14,5	17,8	18,8	30,75	46,5	7	17,2	3	15	3

Dimensions

Dimensions – One-way flow control valves GRLA, standard

Download CAD data → www.festo.com

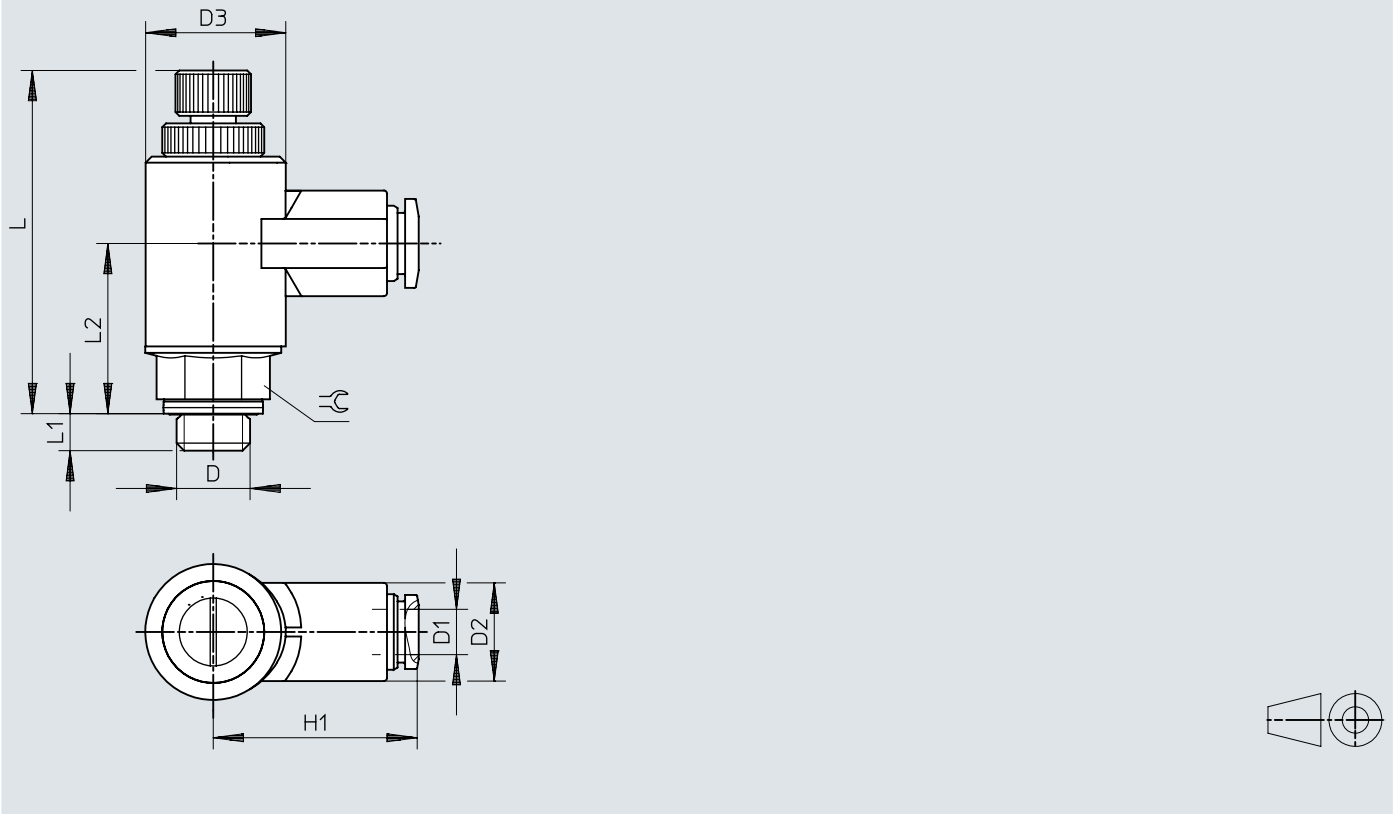

	D	D1 ø	D2 ø	D3 ø	~H1	~L		~L1	~L2	≈ε
GRLA-1/8	G1/8	6	13,0 ±0,25	17,9 -0,1	27,2	48,1	±2,2%	4,9	22,6	13
		8	16,8 ±0,4		35,4	48	±2,3%			
GRLA-1/4	G1/4	6	13,0 ±0,25	17,9 -0,1	27,2	47,8	±2,3%	5,8	22,3	17
		8	16,8 ±0,4		35,4	47,8	±2,4%			
GRLA-3/8	G3/8	6	13,0 ±0,25	17,9 -0,1	27,2	47,8	±2,3%	6,8	22,3	19
		8	16,8 ±0,4		35,4	47,8	±2,4%			

Dimensions

Dimensions – One-way flow control valves GRLA/GRLZ, mini

Download CAD data → www.festo.com

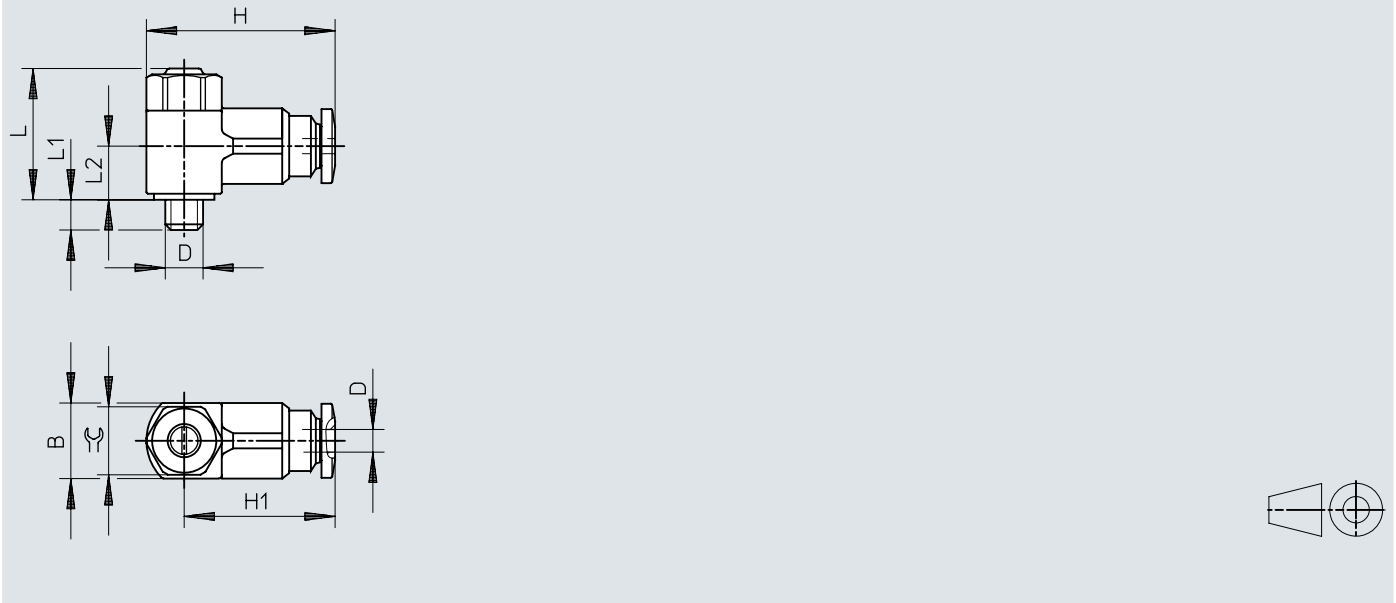

	D	D1 ∅	B	~H	~H1	~L	L1	~L2	≅	
GRLA/GRLZ	M3	3	8 ^{-0,15}	20	15,8	16,6	±3,3%	2,3 ^{+0,15/-0,3}	7	7
	M5	3	9,8 ^{-0,15}	22,4	18,4	17,2	±3,1%	3,1 ^{+0,15/-0,35}	7,3	
		4	9,8 ^{-0,15}	22,2	18,2	17,2	±3,1%	3,1 ^{+0,15/-0,35}	7,3	

Dimensions

Dimensions – Female thread, metal

Download CAD data → www.festo.com

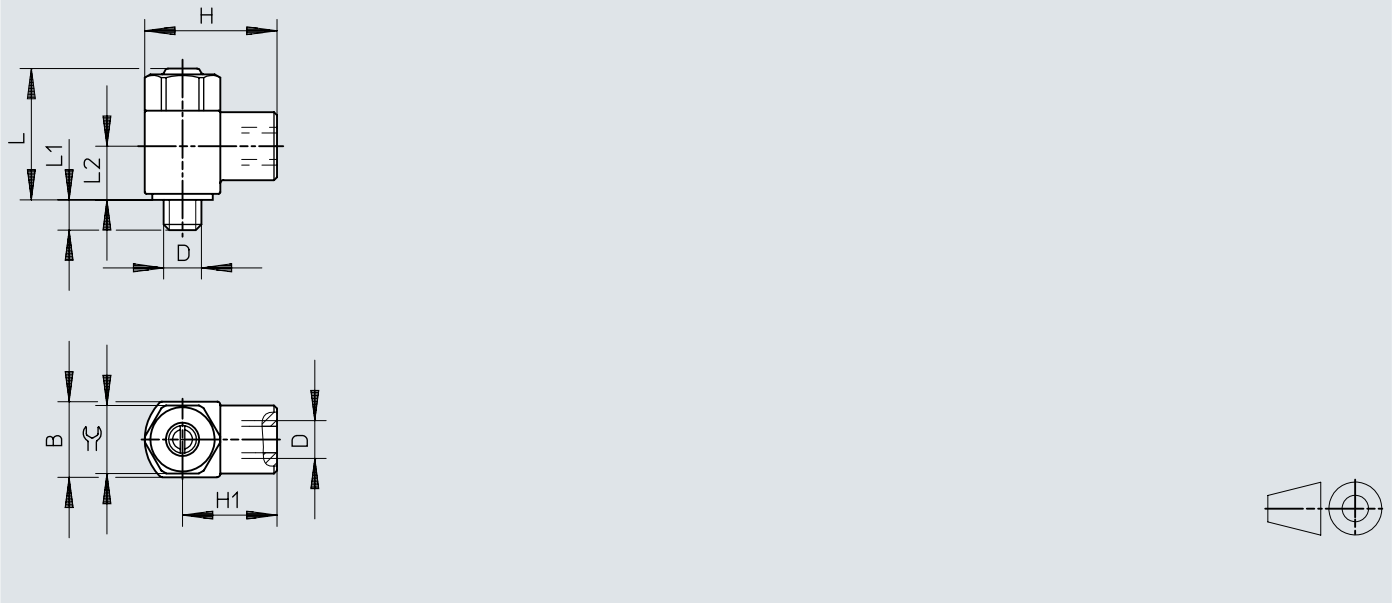

	D	B	~H	~H1	~L	L1	~L2	≅	
GRLA/GRLZ	M3	5 ^{-0,1}	9	6,5	13,4	±3,9%	2,5 ^{+0,15/-0,3}	6,4	4,5

Dimensions

Dimensions – One-way flow control valves CRGRLA-M5, corrosion-resistant

Download CAD data → www.festo.com

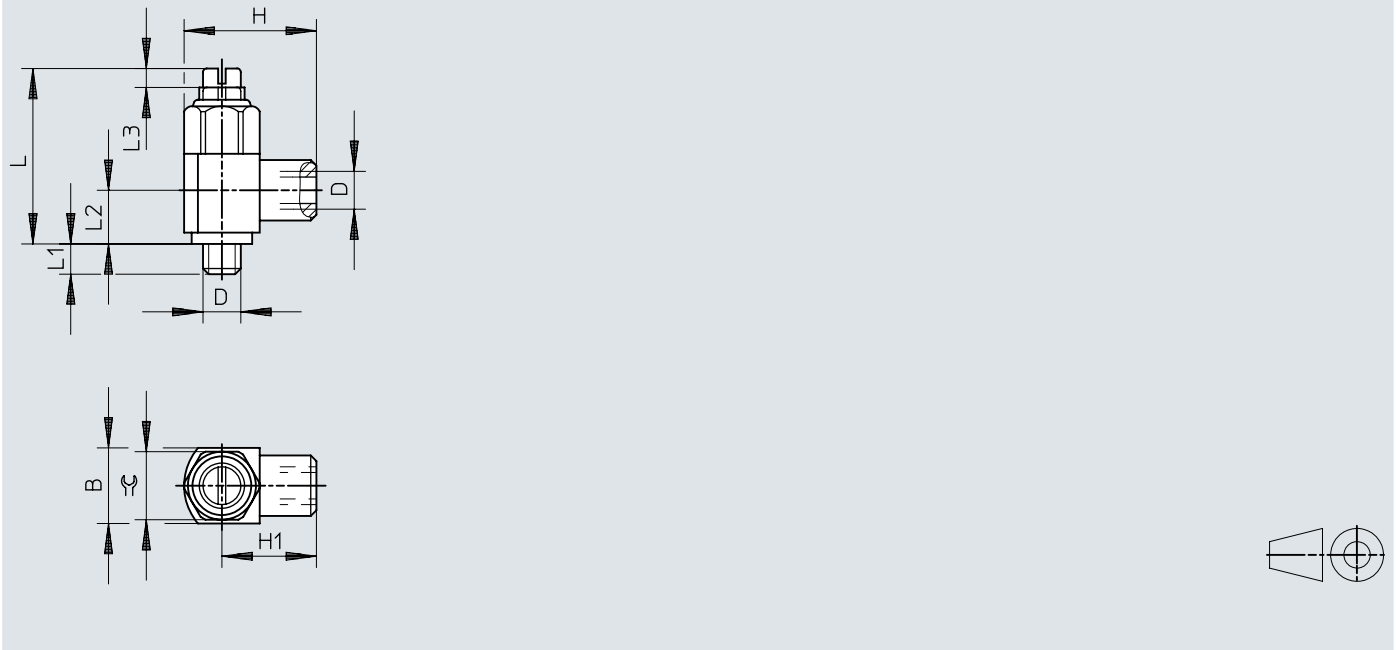

	D	B	H	H1	~L	~L1	~L2	~L3	≈G	
CRGRLA-M5	M5	10 ^{-0,25}	17,5 ^{±0,3}	12,5	22,9	±3,5%	4	7,1	2,5	9

Dimensions

Dimensions – One-way flow control valves CRGRLA, corrosion-resistant

Download CAD data → www.festo.com

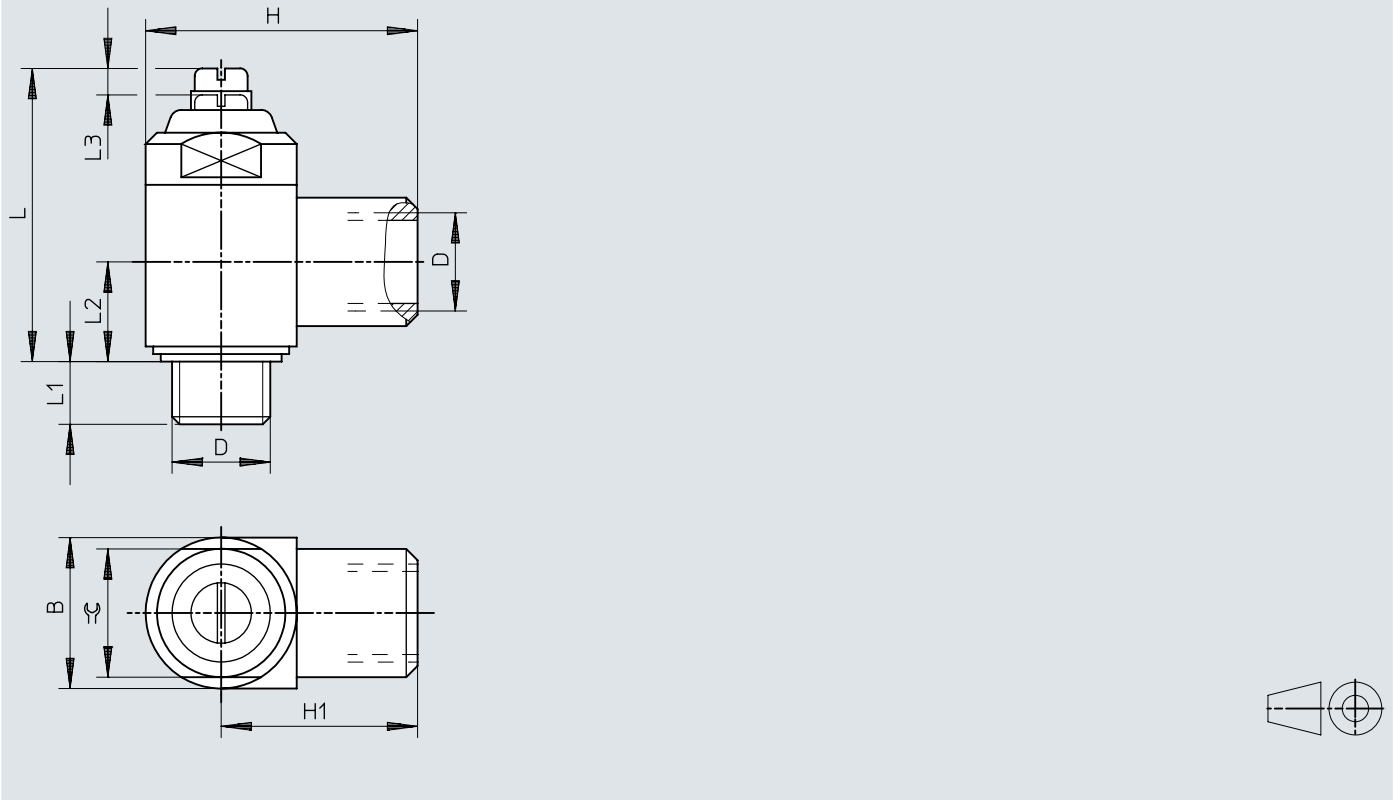

	D	B	H	H1	~L	~L1	~L2	~L3	≈ϕ	
CRGRLA-1/8	G1/8	16 ^{-0,4}	28 ^{+0,4/-0,3}	20	33,8	±2,7%	5,5	10,3	3,5	14
CRGRLA-1/4	G1/4	20 ^{-0,3}	36 ^{+0,4/-0,2}	26	38,8	±2,7%	6,5	13,2	3,5	17
CRGRLA-3/8	G3/8	25 ^{-0,3}	41 ^{+0,4/-0,2}	28,5	48,5	±2,2%	7,5	15,4	5	22
CRGRLA-1/2	G1/2	32 ^{-0,4}	53 ^{±0,5}	37	62,2	±1,7%	9	18,9	7,5	27

Ordering data

Ordering data GRLA – push-in connector QS

	Pneumatic connection, port 2	Pneumatic connection, port 1	Corrosion resistance class CRC	Product weight	Part no.	Type	
	M5	QS-3	0 - No corrosion stress	13 g	★ 193137	GRLA-M5-QS-3-D	
			1 - Low corrosion stress	14 g	197576	GRLA-M5-QS-3-RS-D	
		QS-4	0 - No corrosion stress	13 g	★ 193138	GRLA-M5-QS-4-D	
			1 - Low corrosion stress	14 g	197577	GRLA-M5-QS-4-RS-D	
		QS-6	0 - No corrosion stress	13 g	★ 193139	GRLA-M5-QS-6-D	
			1 - Low corrosion stress	14 g	197578	GRLA-M5-QS-6-RS-D	
	G1/8	QS-3	0 - No corrosion stress	22 g	193142	GRLA-1/8-QS-3-D	
			1 - Low corrosion stress	23 g	197579	GRLA-1/8-QS-3-RS-D	
		QS-4	0 - No corrosion stress	22 g	★ 193143	GRLA-1/8-QS-4-D	
			1 - Low corrosion stress	23 g	197580	GRLA-1/8-QS-4-RS-D	
		QS-6	0 - No corrosion stress	22 g	★ 193144	GRLA-1/8-QS-6-D	
			1 - Low corrosion stress	23 g	197581	GRLA-1/8-QS-6-RS-D	
		QS-8	0 - No corrosion stress	22 g	★ 193145	GRLA-1/8-QS-8-D	
			1 - Low corrosion stress	24 g	534337	GRLA-1/8-QS-8-RS-D	
		G1/4	QS-6	0 - No corrosion stress	42 g	★ 193146	GRLA-1/4-QS-6-D
				1 - Low corrosion stress	50 g	534338	GRLA-1/4-QS-6-RS-D
			QS-8	0 - No corrosion stress	42 g	★ 193147	GRLA-1/4-QS-8-D
				1 - Low corrosion stress	50 g	534339	GRLA-1/4-QS-8-RS-D
	QS-10		0 - No corrosion stress	42 g	★ 193148	GRLA-1/4-QS-10-D	
			1 - Low corrosion stress	50 g	534340	GRLA-1/4-QS-10-RS-D	
	G3/8	QS-6	0 - No corrosion stress	60 g	★ 193149	GRLA-3/8-QS-6-D	
			1 - Low corrosion stress	72 g	534341	GRLA-3/8-QS-6-RS-D	
		QS-8	0 - No corrosion stress	60 g	★ 193150	GRLA-3/8-QS-8-D	
			1 - Low corrosion stress	72 g	534342	GRLA-3/8-QS-8-RS-D	
QS-10		0 - No corrosion stress	60 g	★ 193151	GRLA-3/8-QS-10-D		
		1 - Low corrosion stress	72 g	534343	GRLA-3/8-QS-10-RS-D		
G1/2	QS-12	0 - No corrosion stress	106 g	★ 193152	GRLA-1/2-QS-12-D		
		1 - Low corrosion stress	124 g	534344	GRLA-1/2-QS-12-RS-D		

Ordering data

Ordering data GRLZ – push-in connector QS

	Pneumatic connection, port 2	Pneumatic connection, port 1	Corrosion resistance class CRC	Product weight	Part no.	Type
	M5	QS-3	0 - No corrosion stress	13 g	★ 193153	GRLZ-M5-QS-3-D
		QS-4			★ 193154	GRLZ-M5-QS-4-D
		QS-6			★ 193155	GRLZ-M5-QS-6-D
	G1/8	QS-3		193156	GRLZ-1/8-QS-3-D	
		QS-4		★ 193157	GRLZ-1/8-QS-4-D	
		QS-6		★ 193158	GRLZ-1/8-QS-6-D	
		QS-8		★ 193159	GRLZ-1/8-QS-8-D	

Ordering data GRLA – female thread/barbed connector

	Pneumatic connection, port 2	Pneumatic connection, port 1	Corrosion resistance class CRC	Product weight	Part no.	Type
	Male thread G1/4	Female thread G1/4	2 - Moderate corrosion stress	59 g	151175	GRLA-1/4-RS-B
		For barbed fitting I.D. 4 mm with union nut		44 g	151173	GRLA-1/4-PK-4-B
		For barbed fitting I.D. 6 mm with union nut		45 g	151174	GRLA-1/4-PK-6-B
	M5	M5		11 g	151160	GRLA-M5-B
				12 g	151163	GRLA-M5-RS-B
				10 g	151161	GRLA-M5-PK-3-B
					151162	GRLA-M5-PK-4-B
	G1/8	G1/8		28 g	151165	GRLA-1/8-B
				30 g	151169	GRLA-1/8-RS-B
		22 g		151166	GRLA-1/8-PK-3-B	
				25 g	151167	GRLA-1/8-PK-4-B
					151168	GRLA-1/8-PK-6-B
		G3/8		G3/8	97 g	151178
	G1/2	G1/2	204 g	151179	GRLA-1/2-B	
	G3/4	G3/4	377 g	151180	GRLA-3/4-B	

Ordering data GRLZ – female thread/barbed connector

	Pneumatic connection, port 2	Pneumatic connection, port 1	Corrosion resistance class CRC	Product weight	Part no.	Type
	Male thread G1/4	Female thread G1/4	2 - Moderate corrosion stress	59 g	151198	GRLZ-1/4-RS-B
					151195	GRLZ-1/4-B
	M5	M5		11 g	151183	GRLZ-M5-B
				12 g	151186	GRLZ-M5-RS-B
	G1/8	G1/8		28 g	151188	GRLZ-1/8-B
				30 g	151192	GRLZ-1/8-RS-B

Ordering data GRLSA – push-in connector QS

	Pneumatic connection, port 2	Pneumatic connection, port 1	Corrosion resistance class CRC	Product weight	Part no.	Type
	G1/8	QS-6	1 - Low corrosion stress	19.5 g	540661	GRLSA-1/8-QS-6

Ordering data

Ordering data GRLSA – push-in connector QS

	Pneumatic connection, port 2	Pneumatic connection, port 1	Corrosion resistance class CRC	Product weight	Part no.	Type
	G1/4	QS-8	1 - Low corrosion stress	34.8 g	540662	GRLSA-1/4-QS-8

Ordering data GRLA/GRLZ – push-in connector QS (Mini)

	Pneumatic connection, port 2	Pneumatic connection, port 1	Corrosion resistance class CRC	Product weight	Part no.	Type
	M3	QS-3	1 - Low corrosion stress	7 g	175043	GRLZ-M3-QS-3
					175041	GRLA-M3-QS-3
	M5	QS-4		9 g	175055	GRLZ-M5-QS-3-LF-C
					175053	GRLA-M5-QS-3-LF-C
					175056	GRLA-M5-QS-4-LF-C
			175058	GRLZ-M5-QS-4-LF-C		

Ordering data GRLA/GRLZ – female thread (Mini)

	Pneumatic connection, port 2	Pneumatic connection, port 1	Corrosion resistance class CRC	Product weight	Part no.	Type
	M3	M3	1 - Low corrosion stress	2 g	175038	GRLA-M3
					175040	GRLZ-M3

Ordering data CRGRLA – female thread (stainless steel)

	Pneumatic connection, port 2	Pneumatic connection, port 1	Corrosion resistance class CRC	Product weight	Part no.	Type
	M5	M5	3 - high corrosion stress	10.2 g	161403	CRGRLA-M5-B
	G1/8	G1/8		37.8 g	161404	CRGRLA-1/8-B
	G1/4	G1/4		71.6 g	161405	CRGRLA-1/4-B
	G3/8	G3/8		126.9 g	161406	CRGRLA-3/8-B
	G1/2	G1/2		262.3 g	161407	CRGRLA-1/2-B