

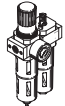

Branching modules FRM/distributor blocks FRZ, D series

FESTO

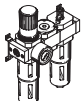

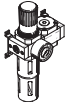
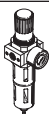

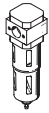
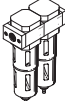
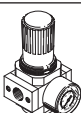

Product range overview – Service unit components, D series, metal

Type	Size	Pneumatic connection										Pressure regulation range [bar]			Grade of filtration [µm]			
		M5	M7	G1/8	G1/4	G3/8	G1/2	G3/4	G1	QS4	QS6	0.5 ...	0.5 ...	2.5 ...	0.01	1	5	40
Service units																		
FRC/FRCS 	Mini	-	-	■	■	■	-	-	-	-	-	■	■	-	-	-	■	■
	Midi	-	-	-	■	■	■	■	-	-	-	■	■	-	-	-	■	■
	Maxi	-	-	-	-	-	■	■	■	-	-	■	■	-	-	-	■	■
FRC-K 	Mini	-	-	■	■	-	-	-	-	-	-	■	■	-	-	-	-	■
	Midi	-	-	-	■	■	■	-	-	-	-	■	■	-	-	-	-	■
	Maxi	-	-	-	-	-	■	■	-	-	-	■	■	-	-	-	-	■
LFR-K 	Mini	-	-	■	■	-	-	-	-	-	-	■	■	-	-	-	-	■
	Midi	-	-	-	■	■	■	-	-	-	-	■	■	-	-	-	-	■
	Maxi	-	-	-	-	-	■	■	-	-	-	■	■	-	-	-	-	■
Individual devices																		
Filter regulators LFR/LFRS 	Mini	-	-	■	■	■	-	-	-	-	-	■	■	-	-	-	■	■
	Midi	-	-	-	■	■	■	■	-	-	-	■	■	-	-	-	■	■
	Maxi	-	-	-	-	-	■	■	■	-	-	■	■	-	-	-	■	■
Filters LF 	Mini	-	-	■	■	■	-	-	-	-	-	-	-	-	-	-	■	■
	Midi	-	-	-	■	■	■	■	-	-	-	-	-	-	-	-	■	■
	Maxi	-	-	-	-	-	■	■	■	-	-	-	-	-	-	-	■	■
Fine and micro filters LFMA/LFMB 	Mini	-	-	■	■	■	-	-	-	-	-	-	-	■	■	-	-	-
	Midi	-	-	-	■	■	■	■	-	-	-	-	-	-	■	■	-	-
	Maxi	-	-	-	-	-	■	■	■	-	-	-	-	-	■	■	-	-
Activated carbon filters LFX 	Mini	-	-	■	■	■	-	-	-	-	-	-	-	-	-	-	-	-
	Midi	-	-	-	■	■	■	■	-	-	-	-	-	-	-	-	-	-
	Maxi	-	-	-	-	-	■	■	■	-	-	-	-	-	-	-	-	-
Filter combinations LF MBA 	Mini	-	-	■	■	■	-	-	-	-	-	-	-	■	■	-	-	-
	Midi	-	-	-	■	■	■	■	-	-	-	-	-	-	■	■	-	-
	Maxi	-	-	-	-	-	■	■	■	-	-	-	-	-	■	■	-	-
Druckregelventile LR/LRS 	Mini	-	-	■	■	■	-	-	-	-	-	■	■	-	-	-	-	-
	Midi	-	-	-	■	■	■	■	-	-	-	■	■	-	-	-	-	-
	Maxi	-	-	-	-	-	■	■	■	-	-	■	■	-	-	-	-	-

Product range overview – Service unit components, D series, metal

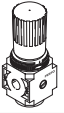
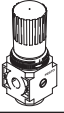
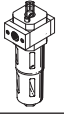
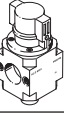
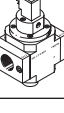
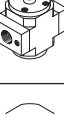
Type	Size	Bowl guard		Condensate drain			Pressure indicator		Actuator lock		Supply voltage			Options			→ Page/ Internet
		Metal bowl guard	Plastic bowl	Manual	Semi-automatic	Fully automatic	With pressure gauge	Without pressure gauge	Rotary knob with latch	Rotary knob with integrated lock	24 V DC	110 V AC	230 V AC	Directly actuated pressure regulator with integrated return flow function	Pilot actuated pressure regulator with integrated return flow function	Differential pressure display	
Service units																	
FRC/FRCS	Mini	■	-	■	-	■	■	■	■	■	-	-	-	-	-	-	frc
	Midi	■	-	■	-	■	■	■	■	■	-	-	-	-	-	-	
	Maxi	■	-	■	-	■	■	■	■	■	-	-	-	■	■	-	
FRC-K	Mini	■	-	■	-	■	■	-	■	-	■	-	-	-	-	-	<?>
	Midi	■	-	■	-	■	■	-	■	-	■	-	-	-	-	-	
	Maxi	■	-	■	-	■	■	-	■	-	■	-	-	■	■	-	
LFR-K	Mini	■	-	■	-	■	■	-	■	■	■	-	-	-	-	-	lfr
	Midi	■	-	■	-	■	■	-	■	■	■	-	-	-	-	-	
	Maxi	■	-	■	-	■	■	-	■	■	■	-	-	■	■	-	
Individual devices																	
Filter regulators LFR/LFRS	Mini	■	-	■	-	■	■	■	■	■	-	-	-	-	-	-	lfr
	Midi	■	-	■	-	■	■	■	■	■	-	-	-	-	-	-	
	Maxi	■	-	■	-	■	■	■	■	■	-	-	-	■	■	-	
Filters LF	Mini	■	-	■	-	■	-	-	-	-	-	-	-	-	-	-	lf
	Midi	■	-	■	-	■	-	-	-	-	-	-	-	-	-	-	
	Maxi	■	-	■	-	■	-	-	-	-	-	-	-	-	-	-	
Fine and micro filters LFMA/LFMB	Mini	■	-	■	-	■	-	-	-	-	-	-	-	-	-	■	lfma, lfmb
	Midi	■	-	■	-	■	-	-	-	-	-	-	-	-	-	■	
	Maxi	■	-	■	-	■	-	-	-	-	-	-	-	-	-	■	
Activated carbon filters LFX	Mini	■	-	-	-	-	-	-	-	-	-	-	-	-	-	-	lfx
	Midi	■	-	-	-	-	-	-	-	-	-	-	-	-	-	-	
	Maxi	■	-	-	-	-	-	-	-	-	-	-	-	-	-	-	
Filter combinations LFMBA	Mini	■	-	■	-	■	-	-	-	-	-	-	-	-	-	■	lfmba
	Midi	■	-	■	-	■	-	-	-	-	-	-	-	-	-	■	
	Maxi	■	-	■	-	■	-	-	-	-	-	-	-	-	-	■	
Pressure regulators LR/LRS	Mini	-	-	-	-	-	■	■	■	■	-	-	-	■	-	-	lr
	Midi	-	-	-	-	-	■	■	■	■	-	-	-	■	-	-	
	Maxi	-	-	-	-	-	■	■	■	■	-	-	-	■	■	-	

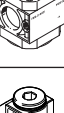
Product range overview – Service unit components, D series, metal

Type	Size	Pneumatic Connection										Pressure regulation range [bar]		
		M5	M7	G1/8	G1/4	G3/8	G1/2	G3/4	G1	QS4	QS6	0.5 ... 7	0.5 ... 12	
Individual devices														
Pressure regulators LRB/LRBS		Mini	-	-	-	■	-	-	-	-	-	-	■	■
		Midi	-	-	-	-	■	-	-	-	-	-	■	■
		Maxi	-	-	-	-	-	-	-	-	-	-	-	-
Pressure regulator manifolds LRB-K		Mini	-	-	-	■	■	-	-	-	-	-	■	■
		Midi	-	-	-	-	■	■	-	-	-	-	■	■
		Maxi	-	-	-	-	-	-	-	-	-	-	-	-
Lubricators LOE		Mini	-	-	■	■	■	-	-	-	-	-	-	-
		Midi	-	-	-	■	■	■	■	-	-	-	-	-
		Maxi	-	-	-	-	-	■	■	■	-	-	-	-
On/off valves HE		Mini	-	-	■	■	■	-	-	-	-	-	-	-
		Midi	-	-	-	■	■	■	■	-	-	-	-	-
		Maxi	-	-	-	-	-	■	■	■	-	-	-	-
On/off valves HEE		Mini	-	-	■	■	■	-	-	-	-	-	-	-
		Midi	-	-	-	■	■	■	■	-	-	-	-	-
		Maxi	-	-	-	-	-	■	■	■	-	-	-	-
On/off valves HEP		Mini	-	-	■	■	■	-	-	-	-	-	-	-
		Midi	-	-	-	■	■	■	■	-	-	-	-	-
		Maxi	-	-	-	-	-	■	■	■	-	-	-	-
Soft-start valves HEL		Mini	-	-	■	■	■	-	-	-	-	-	-	-
		Midi	-	-	-	■	■	■	■	-	-	-	-	-
		Maxi	-	-	-	-	-	■	■	■	-	-	-	-
Membrane air dryers LDM1		Mini	-	-	-	-	-	-	-	-	-	-	-	-
		Midi	-	-	-	-	-	-	-	-	-	-	-	-
		Maxi	-	-	-	-	-	■	■	■	-	-	-	-
Branching modules FRM		Mini	-	-	■	■	■	-	-	-	-	-	-	-
		Midi	-	-	-	■	■	■	■	-	-	-	-	-
		Maxi	-	-	-	-	-	■	■	■	-	-	-	-
Distributor block FRZ		Mini	-	-	-	-	-	-	-	-	-	-	-	-
		Midi	-	-	-	-	-	-	-	-	-	-	-	-
		Maxi	-	-	-	-	-	-	-	-	-	-	-	-

Product range overview – Service unit components, D series, metal

Type	Size	Bowl guard		Pressure indicator		Actuator lock		Supply voltage			Options		→ Page/ Internet
		Metal bowl guard	Plastic bowl	With pressure gauge	Without pressure gauge	Rotary knob with latch	Rotary knob with integrated lock	24 V DC	110 V AC	230 V AC	With non-return function	Pressure switch	
Individual devices													
Pressure regulators LRB/LRBS	Micro	-	-	-	■	■	■	-	-	-	-	-	lrb
	Mini	-	-	-	■	■	■	-	-	-	-	-	
	Midi	-	-	-	-	-	-	-	-	-	-	-	
Pressure regulator manifolds LRB-K	Mini	-	-	-	■	■	-	-	-	-	-	-	lrb
	Midi	-	-	-	■	■	-	-	-	-	-	-	
	Maxi	-	-	-	-	-	-	-	-	-	-	-	
Lubricators LOE	Mini	■	-	-	■	-	-	-	-	-	-	-	loe
	Midi	■	-	-	■	-	-	-	-	-	-	-	
	Maxi	■	-	-	■	-	-	-	-	-	-	-	
On/off valves HE	Mini	-	-	-	■	■	-	-	-	-	-	-	he
	Midi	-	-	-	■	■	-	-	-	-	-	-	
	Maxi	-	-	-	■	■	-	-	-	-	-	-	
On/off valves HEE	Mini	-	-	-	■	-	-	■	■	■	-	-	hee
	Midi	-	-	-	■	-	-	■	■	■	-	-	
	Maxi	-	-	-	■	-	-	■	■	■	-	-	
On/off valves HEP	Mini	-	-	-	■	-	-	-	-	-	-	-	hep
	Midi	-	-	-	■	-	-	-	-	-	-	-	
	Maxi	-	-	-	■	-	-	-	-	-	-	-	
Soft-start valves HEL	Mini	-	-	-	■	-	-	-	-	-	-	-	hel
	Midi	-	-	-	■	-	-	-	-	-	-	-	
	Maxi	-	-	-	■	-	-	-	-	-	-	-	
Membrane air dryers LDM1	Mini	-	-	-	-	-	-	-	-	-	-	-	ldm1
	Midi	-	-	-	-	-	-	-	-	-	-	-	
	Maxi	■	-	-	■	-	-	-	-	-	-	-	
Branching modules FRM	Mini	-	-	-	■	-	-	-	-	-	■	■	frm
	Midi	-	-	-	■	-	-	-	-	-	■	■	
	Maxi	-	-	-	■	-	-	-	-	-	■	■	
Distributor block FRZ	Mini	-	-	-	■	-	-	-	-	-	-	-	frz
	Midi	-	-	-	■	-	-	-	-	-	-	-	
	Maxi	-	-	-	■	-	-	-	-	-	-	-	

Peripherals overview

Mini/Midi/Maxi

Individual unit with connecting plates

Individual unit without connecting plates, for service unit combination

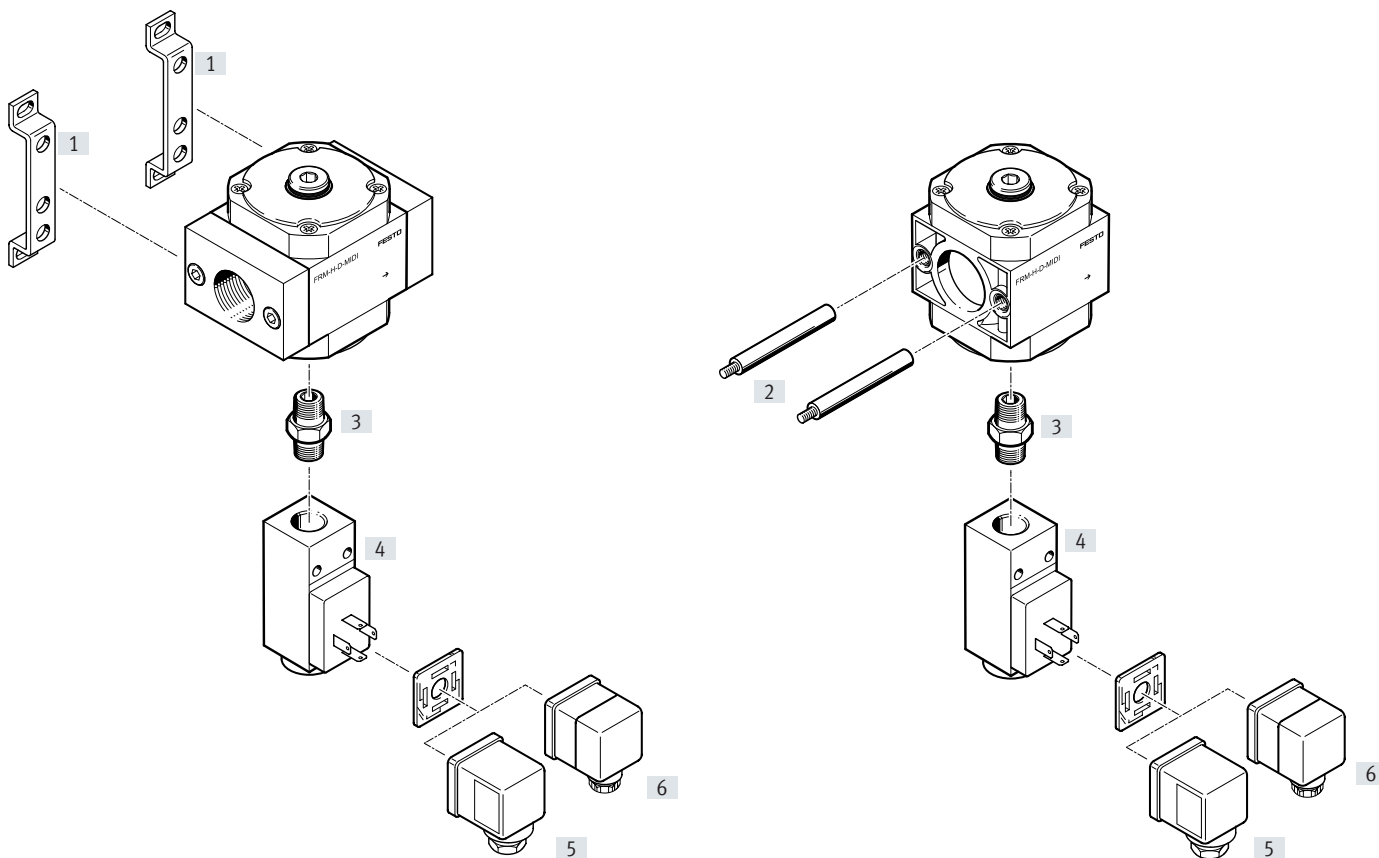

Mounting attachments and accessories

	Single device		Combination		→ Page/Internet
	With connecting plates	Without connecting plates	With connecting plates	Without connecting plates	
[1] Mounting bracket HFOE	■	-	■	-	hfoe-d
[2] Threaded bolt (included in the scope of delivery) FRB	-	-	■	■	frb-d
[3] Double nipple ESK	■	■	■	■	14
[4] Pressure switch PEV	■	■	■	■	14
[5] Plug socket MSSD-C	■	■	■	■	14
[6] Angled plug socket PEV...-WD-LED	■	■	■	■	14

Type codes

001	Series
FRM	Branching module

002	Additional function
	None
H	With integrated non-return function
Y	Pressure switch, connection A1

003	Pneumatic connection
	None
1/8	Female thread G1/8
1/4	Female thread G1/4
3/8	Female thread G3/8
1/2	Female thread G1/2
3/4	Female thread G3/4
1	Female thread G1

004	Version
D	D series, metal

005	Size
MINI	Grid dimension 40 mm (without connecting plates)
MIDI	Grid dimension 55 mm (without connecting plates)
MAXI	Grid dimension 66 mm (without connecting plates)

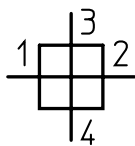

Datasheet

Function
Branching module, standard

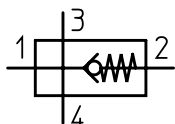

Branching module with integrated non-return function



-  - Flow rate
1100 ... 20000 l/min
-  - Temperature range
-10 ... +60 °C
-  - Operating pressure
0 ... 16 bar



- Branching module for compressed air distribution for attachment of auxiliary modules (pressure regulator, pressure switch, etc.)
- An integrated check valve prevents the return flow of lubricated compressed air
- Several additional air connections for greater flexibility
- Can be used as an intermediate distributor for varying air qualities

General technical data													
Size	Mini				Midi					Maxi			
Pneumatic connection 1, 2	G1/8	G1/4	G3/8	- ¹⁾	G1/4	G3/8	G1/2	G3/4	- ¹⁾	G1/2	G3/4	G1	- ¹⁾
Pneumatic connection 3	G1/4				G1/2					G3/4			
Pneumatic connection 4	G1/4												
Design	Branching module												
Type of mounting	Via accessories												
	In-line installation												
Mounting position	Any												
Air purity class at the output	Compressed air to ISO 8573-1:2010 [7:-:-]												
	Inert gases												

1) Without connecting plates.

† Note: This product conforms to ISO 1179-1 and ISO 228-1.

Standard nominal flow rate $q_{nN}^{1)}$ [l/min]														
Size	Mini				Midi					Maxi				
Pneumatic connection 1, 2	G1/8	G1/4	G3/8	- ²⁾	G1/4	G3/8	G1/2	G3/4	- ²⁾	G1/2	G3/4	G1	- ²⁾	
Branching module, standard														
In main flow direction 1 → 2	1400	3300	2900	3300	3300	6700	8200	8800	8200	11700	20000	17400	20000	
Branching module with integrated non-return function														
In main flow direction 1 → 2	1100	2000	2100	2000	3100	4900	5100	5000	5100	9000	13500	12300	13500	
Branching module with pressure switch														
In main flow direction 1 → 2	-			3300	-				8200	-		20000		

1) Measured at $p_1 = 6$ bar and $\Delta p = 1$ bar.

2) Without connecting plates.

Datasheet

Operating and environmental conditions							
Branching module		Standard		With integrated non-return function			With pressure switch
Size		Mini/Midi/Maxi		Mini	Midi	Maxi	Mini/Midi/Maxi
Operating pressure	[MPa]	0 ... 1.6		0.015 ... 1.6	0.02 ... 1.6	0.025 ... 1.6	0 ... 1.2
	[bar]	0 ... 16		0.15 ... 16	0.2 ... 16	0.25 ... 16	0 ... 12
	[psi]	0 ... 232		2.175 ... 232	2.9 ... 232	3.625 ... 232	0 ... 174
Operating medium		Compressed air to ISO 8573-1:2010 [7:-:-]					
		Inert gases					
Ambient temperature	[°C]	-10 ... +60					
Temperature of medium	[°C]	-10 ... +60					
Storage temperature	[°C]	-10 ... +60					
Corrosion resistance class CRC ¹⁾		2					

 1) More information www.festo.com/x/topic/crc

Weight [g]													
Size	Mini				Midi					Maxi			
Pneumatic connection 1, 2	G1/8	G1/4	G3/8	- ¹⁾	G1/4	G3/8	G1/2	G3/4	- ¹⁾	G1/2	G3/4	G1	- ¹⁾
Branching module, standard													
FRM-D	322	321	322	230	532	522	502	472	382	702	662	772	442
Branching module with integrated non-return function													
FRM-H-D	325	324	325	233	536	526	506	476	386	706	666	776	446
Branching module with pressure switch													
FRM-Y-D	-			507	-				662	-		822	

1) Without connecting plates.

Materials

Sectional view

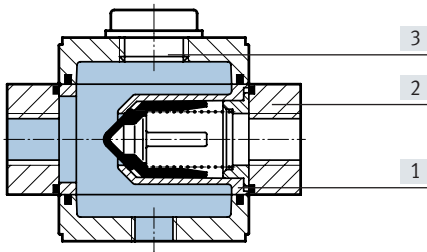

Branching module		
[1]	Housing	Die-cast aluminium FRM-H...-D-MAXI: Die-cast zinc
[2]	Connecting plates	Die-cast zinc
[3]	Plug screw	Galvanised steel
-	Seals	NBR
Note on materials		RoHS-compliant
LABS (PWIS) conformity		VDMA24364-B1/B2-L

Datasheet

Dimensions

Download CAD data → www.festo.com

Connecting plates with threaded connection
Mini/Maxi

Without connecting plates

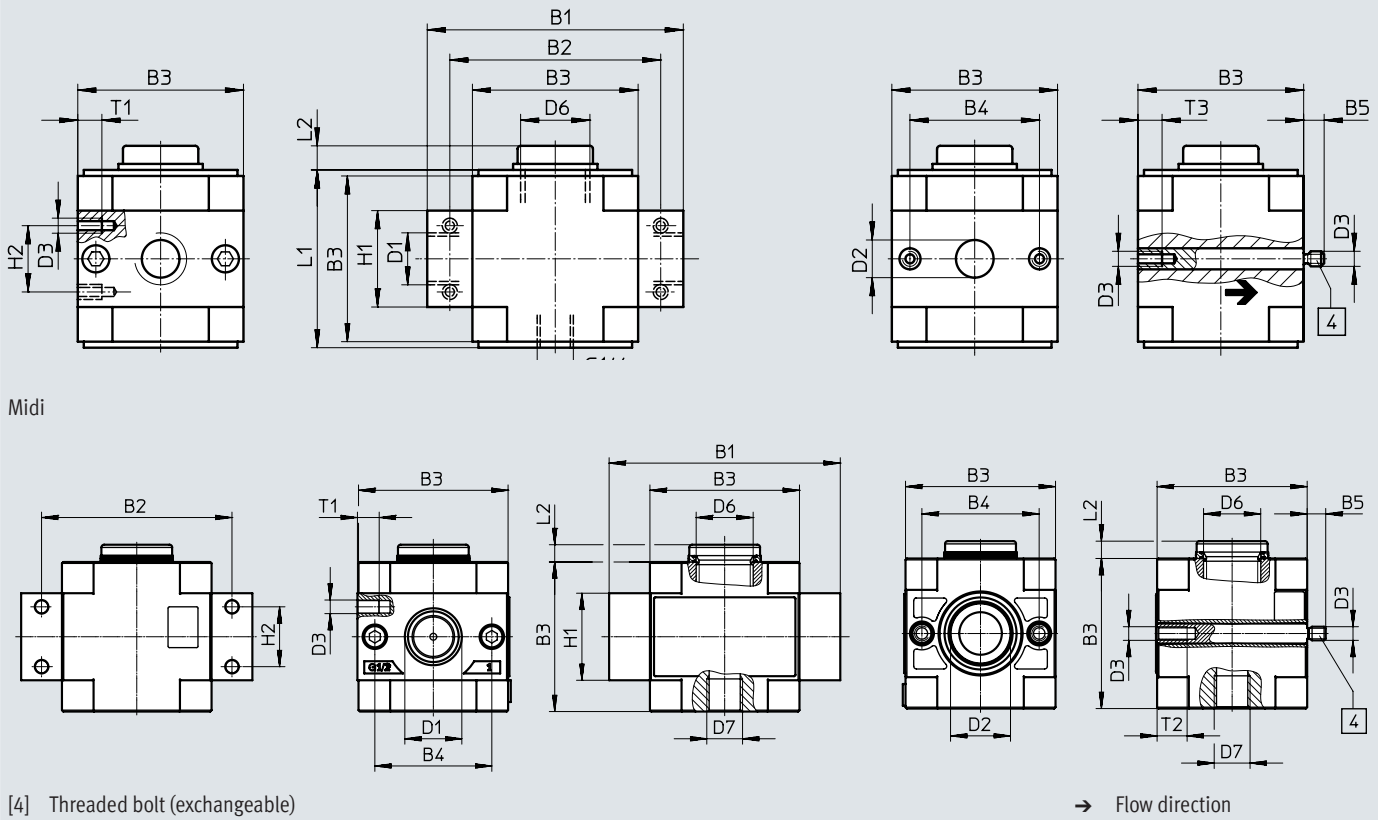

Type	B1	B2	B3	B4	B5	D1	D2 ∅	D3	D6	D7	H1	H2	L1	L2	T1	T2
Mini																
FRM-1/8-D-MINI	64	52	40	30	-	G1/8	-	M4	G1/4	G1/4	20	11	42	7	7	-
FRM-1/4-D-MINI						G1/4										
FRM-3/8-D-MINI	70					G3/8										
FRM-D-MINI	-	-			5.8	-	11								-	10
Midi																
FRM-1/4-D-MIDI	85	70	55	43	-	G1/4	-	M5	G1/2	G1/4	32	22	-	6.4	8	-
FRM-3/8-D-MIDI						G3/8										
FRM-1/2-D-MIDI						G1/2										
FRM-3/4-D-MIDI						G3/4										
FRM-D-MIDI	-	-			6.8	-	22								-	11
Maxi																
FRM-1/2-D-MAXI	96	80	66	46	-	G1/2	-	M5	G3/4	G1/4	32	22	70	8	8	-
FRM-3/4-D-MAXI						G3/4										
FRM-1-D-MAXI	116	91				G1										
FRM-D-MAXI	-	-			6.8	-	30								-	11

• Note: This product conforms to ISO 1179-1 and ISO 228-1.

Datasheet

Dimensions – Pressure switch

 Download CAD data → www.festo.com

Pressure switch with adjustable pressure switching point

Datasheets → Internet: pev-1/4

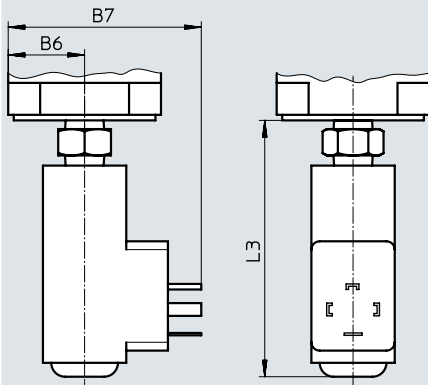

Pressure switch PEV-1/4-B-0D with adjustable pressure switching point, plug, square design to EN 175 301, type A

Type	B6	B7	L3
FRM-Y-D-MINI	20	62	92.3
FRM-Y-D-MIDI	27.5	69.5	92.3
FRM-Y-D-MAXI	33	75	92.3

Ordering data

Size	Connection	Branching module, standard		Branching module with integrated non-return function		Branching module with pressure switch PEV-1/4-B-0D	
		Part no.	Type	Part no.	Type	Part no.	Type
Without connecting plates							
Mini	–	170684	FRM-D-MINI	170687	FRM-H-D-MINI	542184	FRM-Y-D-MINI
Midi	–	170685	FRM-D-MIDI	170688	FRM-H-D-MIDI	542185	FRM-Y-D-MIDI
Maxi	–	170686	FRM-D-MAXI	170689	FRM-H-D-MAXI	542186	FRM-Y-D-MAXI
Connecting plates with threaded connection							
Mini	G1/8	164949	FRM-1/8-D-MINI	162788	FRM-H-1/8-D-MINI	–	
	G1/4	164950	FRM-1/4-D-MINI	162789	FRM-H-1/4-D-MINI		
	G3/8	164951	FRM-3/8-D-MINI	162790	FRM-H-3/8-D-MINI		
Midi	G1/4	186523	FRM-1/4-D-MIDI	186525	FRM-H-1/4-D-MIDI		
	G3/8	164952	FRM-3/8-D-MIDI	162791	FRM-H-3/8-D-MIDI		
	G1/2	164953	FRM-1/2-D-MIDI	162792	FRM-H-1/2-D-MIDI		
Maxi	G3/4	164954	FRM-3/4-D-MIDI	162793	FRM-H-3/4-D-MIDI		
	G1/2	186524	FRM-1/2-D-MAXI	186526	FRM-H-1/2-D-MAXI		
	G3/4	164955	FRM-3/4-D-MAXI	162794	FRM-H-3/4-D-MAXI		
	G1	164956	FRM-1-D-MAXI	162795	FRM-H-1-D-MAXI		

Type codes

001	Series
FRZ	Distributor block

002	Version
D	D series, metal

003	Size
MINI	Grid dimension 40 mm (without connecting plates)
MIDI	Grid dimension 55 mm (without connecting plates)
MAXI	Grid dimension 66 mm (without connecting plates)

Datasheet

Function

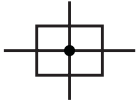

Filtered, unlubricated compressed air can be branched via additional air connections, e.g. to supply compressed air to air barriers, sensors and controllers or, for especially clean compressed air, in combination with micro filter LFM.

Materials:

Housing: Aluminium

Plug screw: Galvanised steel

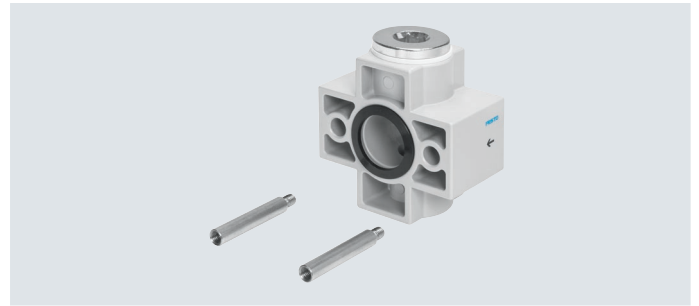

Dimensions

Download CAD data → www.festo.com

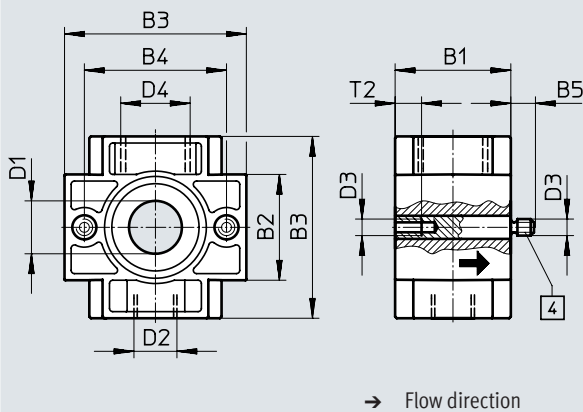

Type	B1	B2	B3	B4	B5	D1 ∅	D2	D3	D4	T2
Mini										
FRZ-D-MINI	30	20	40	30	6	12	G1/4	M4	G1/4	12
Midi										
FRZ-D-MIDI	35	32	55	43	7	16	G1/4	M5	G1/2	8
Maxi										
FRZ-D-MAXI	40	32	65	46	7	22	G1/4	M5	G3/4	10

† Note: This product conforms to ISO 1179-1 and ISO 228-1.

Ordering data

Distributor block

Size	Part no.	Type
Without connecting plates		
Mini	162786	FRZ-D-MINI
Midi	159592	FRZ-D-MIDI
Maxi	162787	FRZ-D-MAXI

Without connecting plates

Mini	162786	FRZ-D-MINI
Midi	159592	FRZ-D-MIDI
Maxi	162787	FRZ-D-MAXI

Accessories

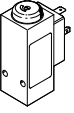
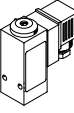
Ordering data – Pressure switches PEV				Datasheets → Internet: pev-1/4	
	Pneumatic connection	Pressure switching point	Electrical connection	Part no.	Type
	G1/4	Adjustable With visual scale	Plug, square design to DIN EN 175 301, type A	161760	PEV-1/4-SC-0D
	G1/4	Adjustable	Plug, square design to DIN EN 175 301, type A	175250	PEV-1/4-B-0D
	G1/4	Adjustable	Plug socket MSSD-C-4P	10773	PEV-1/4-B

Ordering data – Angled plug socket PEV					Datasheets → Internet: pev-1/4	
	Description	Operating voltage range	Electrical connection	Switching status indication	Part no.	Type
	For PEV-1/4-...-OD	15 30 V DC	4-pin	Yellow LED	164274	PEV-1/4-WD-LED-24
		≤ 230 V AC ≤ 180 V DC	4-pin	Yellow LED	164275	PEV-1/4-WD-LED-230

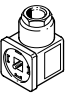
Ordering data – Plug socket MSSD-C-4P					Datasheets → Internet: mssd-c-4p	
	Description	Operating voltage range	Electrical connection	Type of mounting for cable connection	Part no.	Type
	For PEV-1/4-...-OD	≤ 250 V AC/DC	3-pin	Clamping screws	171157	MSSD-C-4P

Ordering data – Double nipple ESK					
	Description	Pneumatic connection		Part no.	Type
	Adjustable for angular compensation • For subsequent mounting of pressure switch PEV on branching module FRM	R1/4	R1/4	151521	ESK-1/4-1/4