

Electric cylinder unit EPCS

FESTO

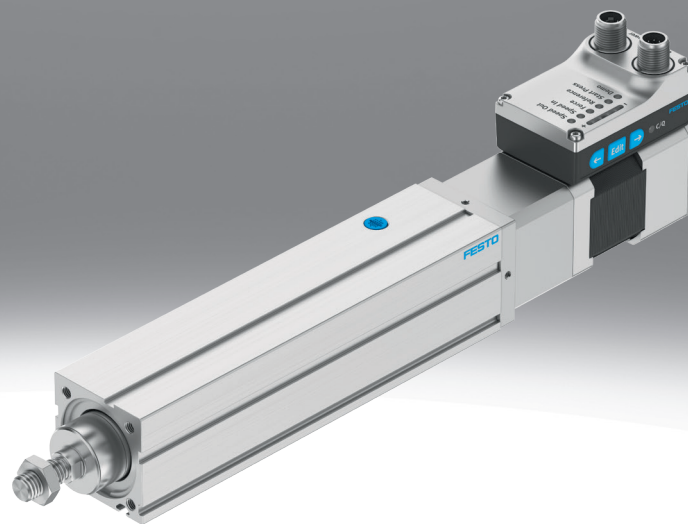

Characteristics

At a glance

Further information → [epcs](#)



The simplicity of pneumatics is now combined for the first time with the advantages of electric automation thanks to the Simplified Motion Series. These integrated drives are the perfect solution for users who are looking for an electric alternative for very simple motion and positioning tasks between two mechanical end positions, but don't want the commissioning process for traditional electric drive systems that can often be quite complex.

- No external servo drive: all necessary electronic components combined in the integrated drive
- Two control options integrated as standard: digital I/O and IO-Link®
- Complete solution for simple movements between mechanical end positions
- Simplified commissioning: all parameters can be manually set directly on the drive
- No special knowledge required for commissioning
- Minimal zero stroke and extremely compact design make this product the perfect choice for applications where space is at a premium
- Very high-quality ball screw with low internal friction
- Ideal for fast movement in sorting, distribution and testing applications

Cylinder with guide unit

- For protecting the piston rod against rotation
- For precise movements

Ordering data - modular system

Further information → [epcs](#)

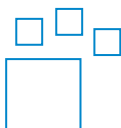

Configurable product

This product and all its product options can be ordered online via the configurator.

Engineering tools

Further information → [engineering tools](#)

Save time with engineering tools Smart Engineering for the optimal solution. Our goal is to increase your productivity. Our engineering tools play an integral part in this. They help you size your system correctly, tap into unimagined productivity reserves and generate additional productivity along the entire value chain. In every phase of your project, from the initial contact to the modernisation of your machine, you will come across a number of different tools which will be of use to you.

Simplified Motion Series - Solution Finder

- Selection tool for simple electric drive solutions from the Simplified Motion Series: This Solution Finder makes finding solutions for electric motion tasks child's play. All you have to do is enter the main application parameters like stroke, payload and motion type, and the system suggests the best solution for your simple motion task in seconds. Then you can simply add it to your shopping basket with just one click and order it online.

Diagrams

Further information → [epcs](#)



The diagrams shown in this document are also available online. These can be used to display precise values.

Spindle pitch

The spindle pitch describes the distance travelled by the spindle nut per revolution of the spindle in millimetres.

Characteristics

Position sensing

By using proximity switches, any position can be detected.

Motor type

IO-Link

The motor is integrated into the drive and can be easily commissioned according to the “plug and work” principle. The relevant parameters can be set directly on the drive. Control is via digital I/O or IO-Link.

Control panel

When aligning the motor, make sure that the buttons (for parameterisation and control) can be used.

[H1] Integrated

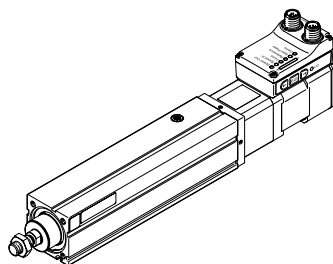

Bus protocol/activation

PNP or NPN switching outputs can be selected for actuation.

End-position sensing

End position feedback similar to a conventional proximity switch, integrated as standard

Cable outlet direction

Describes the alignment of the motor on the drive. Depending on the alignment, the connecting cables can be routed according to the customer's specifications. The cables are positioned at a 45° angle to the axis.

[] Standard

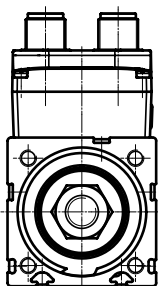

[D] Underneath

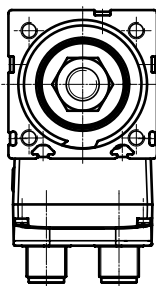

[L] Left

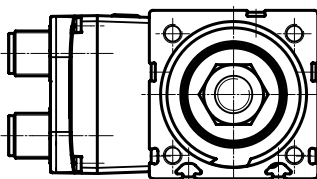

[R] Right

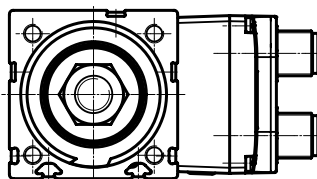

Characteristics

Motor attachment position

[L] Standard

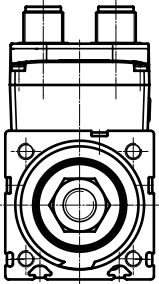

[PL] Parallel, left

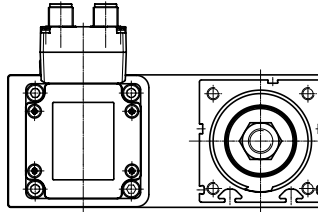

[PR] Parallel, right

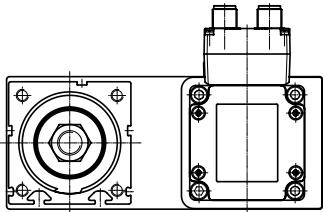

[PD] Parallel, bottom

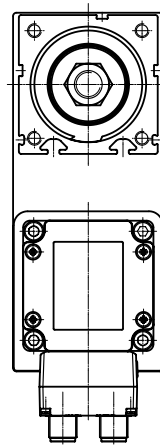

[PT] Parallel, top

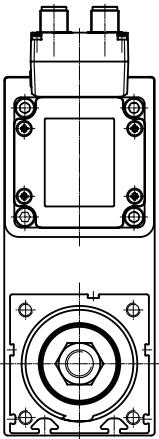

Electrical accessories

Connecting cable between the motor and IO-Link master

Characteristics

Overview

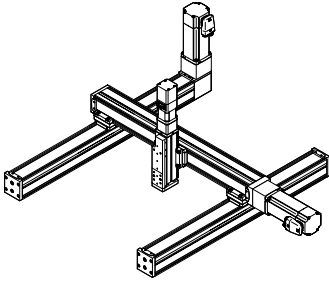

- From the individual axis to the handling system, such as a cantilever system, planar surface gantry or three-dimensional gantry
- The toothed belt and spindle axes ELGC and mini slides EGSC form a scalable modular system for compact automation systems
- The common platform architecture provides an integrated range with matching interfaces. A large number of systems can be implemented completely without adapter plates
- High-performance drive and guide elements ensure a long service life as well as excellent load-bearing capacity and reliability
- The uniform and universal range of accessories reduces warehousing and design costs

Type code

001	Series	
EPCS	Electric cylinder	

002	Drive system	
BS	Ball screw drive	

003	Size	
32	32	
45	45	
60	60	

004	Stroke [mm]	
25	25	
50	50	
75	75	
100	100	
125	125	
150	150	
175	175	
200	200	
250	250	
300	300	
350	350	
400	400	
500	500	

005	Spindle pitch	
3P	3 mm	
5P	5 mm	
8P	8 mm	
10P	10 mm	
12P	12 mm	

006	Position sensing	
A	For proximity sensor	

007	Motor type	
ST	Stepper motor ST	

008	Controller	
M	Integrated	

009	Control panel	
H1	Integrated	

010	Bus protocol/activation	
PLK	PNP and IO-Link®	
NLK	NPN and IO-Link®	

011	End-position sensing	
AA	With integrated end-position sensing	

012	Cable outlet direction	
	Standard	
D	Underneath	
L	Left	
R	Right	

013	Motor attachment position	
	Standard	
PL	Parallel, left	
PR	Parallel, right	
PD	Parallel, bottom	
PT	Parallel, top	

014	Electrical accessories	
	None	
L1	Adapter for operation as IO-Link® device	

Datasheet

General technical data			
Size	32	45	60
Design	Electric cylinder, With ball screw drive, With integrated drive		
Type of motor	Stepper motor		
Protection against torque/ guide	With plain-bearing guide		
Piston-rod end	Male thread		
Piston rod thread	M8	M10x1.25	M12x1.25
Stroke	25 mm; 50 mm; 100 mm; 150 mm; 200 mm	25 mm; 50 mm; 100 mm; 150 mm; 200 mm; 250 mm; 300 mm	25 mm; 50 mm; 100 mm; 150 mm; 200 mm; 250 mm; 300 mm; 350 mm; 400 mm; 500 mm
Stroke reserve	0 mm		
Torsional backlash at piston rod +/-	1 deg		
Additional functions	User interface Integrated end-position sensing		
Display	LED		
Referencing	Positive fixed stop block Negative fixed stop block Reference switch		
Type of mounting	Via female thread With accessories		
Mounting position	optional		
Max. cable length	15 m outputs 15 m inputs 20 m with IO-Link® operation		

Mechanical data			
Size	32	45	60
Spindle pitch	3	8	5
Spindle diameter	8 mm	10 mm	12 mm
Reference value effective load, horizontal	24 kg	60 kg	40 kg
Reference value effective load, vertical	12 kg	9 kg	23 kg
Max. feed force F _x	150 N	450 N	250 N
Max. radial force at drive shaft	75 N	180 N	230 N
Max. speed ¹⁾	0.079 m/s	0.21 m/s	0.074 m/s
Speed "Speed press"	0.01 m/s	0.23 m/s	0.09 m/s
Max. acceleration ²⁾	1.5 m/s ²	5 m/s ²	1.5 m/s ²
Repetition accuracy	±0.02 mm	0.22 m/s	1.5 m/s ²
Reversing backlash theoretical ³⁾	100 µm	5 m/s ²	5 m/s ²
Position sensing	For proximity sensor		

1) Adjustable in steps of 10%.

2) Parameter cannot be changed.

For parallel kit:

EPCS-...-3P/5P: 0.5 m/s²

EPCS-...-8P/10P/12P: 1.5 m/s²

3) In new condition.

Spindle			
Size	32	45	60
Spindle diameter	8 mm	10 mm	12 mm
Spindle pitch	3 ... 8 mm/U	3 ... 10 mm/U	5 ... 12 mm/U

Datasheet

Electrical data			
Size	32	45	60
Nominal voltage DC	24 V		
Permissible voltage fluctuations	+/- 15%		
Nominal current	3 A		5.3 A
Max. current consumption	3 A		5.3 A
Max. current consumption, logic	0.3 A		
Rotor position sensor	Absolute single-turn encoder		
Rotor position sensor, encoder measuring principle	Magnetic		
Rotor position transducer resolution	16 bit		

Interfaces			
Size	32	45	60
Parameterisation interface	IO-Link, User interface		
Working range of logic input	24 V		
Number of digital logic inputs	2		
Features of logic input	Configurable Not galvanically isolated		
Switching logic for inputs	NPN (negative switching) PNP (positive switching)		
Specification logic input	Based on IEC 61131-2, type 1		
Max. current digital logic outputs	100 mA		
Number of digital logic outputs 24 V DC	2		
Features of digital logic outputs	Configurable Not galvanically isolated		
Switching logic for outputs	NPN (negative switching) PNP (positive switching)		

Technical data IO-Link®			
Size	32	45	60
IO-Link, SIO-Mode support	Yes		
IO-Link, communication mode	COM3 (230.4 kBaud)		
IO-Link, Port class	A		
IO-Link, Number of ports	1		
IO-Link, Process data length OUT	2 bytes		
IO-Link, Process data content OUT	Move in 1 bit Move out 1 bit Quit Error 1 bit Move intermediate 1 bit		
IO-Link, Process data length IN	2 bytes		
IO-Link, Process data content IN	State In 1 bit State Out 1 bit State Move 1 bit State Device 1 bit State Intermediate 1 bit		
IO-Link, Service data IN	32-bit force 32-bit position 32-bit speed		
IO-Link, Min. cycle time	1 ms		
IO-Link, Data storage required	0.5 KB		
IO-Link, Protocol version	Device V 1.1		

Datasheet

Operating and ambient conditions			
Size	32	45	60
Ambient temperature	0 ... 50°C		
Storage temperature	-20 ... 60°C		
Note on ambient temperature	Power must be reduced by 2% per K at ambient temperatures above 30°C.		
Temperature monitoring	Switch-off for excessive temperature Integrated precise CMOS temperature sensor with analogue output		
Relative air humidity	0 - 90%, Non-condensing		
Insulation protection class	B		
Protection class	III		
Degree of protection	IP40		
Duty cycle	100%		
CE mark (see declaration of conformity) ¹⁾	To EU EMC Directive In accordance with EU RoHS Directive		
CE marking (see declaration of conformity) ²⁾	To UK instructions for EMC To UK RoHS instructions		
KC mark	KC-EMV		
Approval	RCM trademark		
Vibration resistance	Transport application test with severity level 1 to FN 942017-4 and EN 60068-2-6		
Shock resistance	Shock test with severity level 1 to FN 942017-5 and EN 60068-2-27		
Cleanroom class	Class 9 according to ISO 14644-1		
Maintenance interval	Life-time lubrication		

1) Further information www.festo.com/catalogue/... → Support/Downloads.

2) Further information www.festo.com/catalogue/... → Support/Downloads.

Weight			
Size	32	45	60
Basic weight for 0 mm stroke ¹⁾	818 g, 982 g	1,185 g, 1,308 g	2,294 g, 2,558 g
Additional weight per 10 mm stroke	24 g	41 g	69 g
Moving mass for 0 mm stroke	98 g	179 g	305 g
Additional moving mass per 10 mm stroke	3.3 g	4.9 g	6.5 g

1) For axial motor mounting / for parallel motor mounting

Materials			
Size	32	45	60
Material housing	Smooth-anodised wrought aluminium alloy		
Material piston rod	High-alloy stainless steel		
Material spindle	Rolled steel		
Material spindle nut	Steel		
LABS (PWIS) conformity	VDMA24364 zone III		
Note on materials	RoHS-compliant		

Datasheet

Max. permissible loads on the piston rod

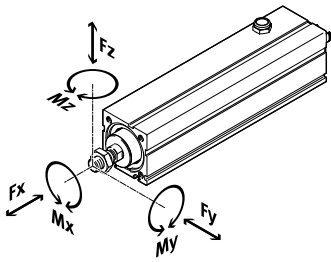

Size	32		45		60	
Spindle pitch	3	8	3	10	5	12
Max. feed force Fx	150 N		450 N	250 N	900 N	375 N
Max. moment Mx	0 Nm					
Max. moment My	1.5 Nm		2.9 Nm		6.4 Nm	
Max. moment Mz	1.5 Nm		2.9 Nm		6.4 Nm	

Calculation of the load comparison factor

$$f_v = \frac{|F_{y1}|}{F_{y2}} + \frac{|F_{z1}|}{F_{z2}} + \frac{|M_{x1}|}{M_{x2}} + \frac{|M_{y1}|}{M_{y2}} + \frac{|M_{z1}|}{M_{z2}} \leq 1$$

If the piston rod is subjected to two or more of the indicated forces and torques simultaneously, the following equation must be satisfied in addition to the indicated maximum loads.

F1 / M1 = dynamic value

F2 / M2 = maximum value

Max. permissible transverse forces F on the piston rod as a function of projection A

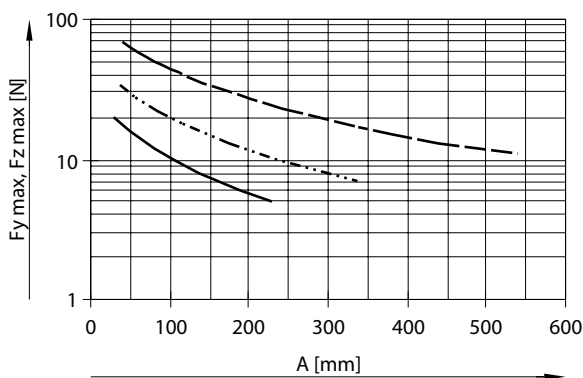

- EPCS-BS-32
- - - EPCS-BS-45
- · - EPCS-BS-60

Note:

Sizing software "Electric Motion Sizing"

Datasheet

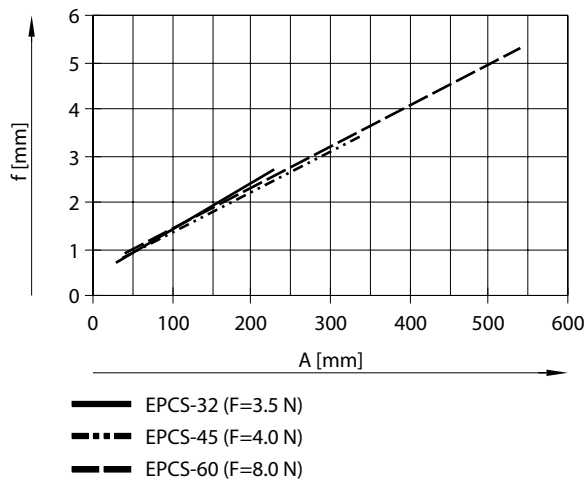
Piston rod deflection f as a function of cantilever load A and lateral force F Piston rod deflection f as a function of cantilever load A and transverse force F

$$f_1 = \frac{F_1}{F_2} \cdot f_2$$

f_1 = Piston rod deflection caused by lateral force [mm]

F_1 = Lateral force [N]

F_2 = Standardised lateral force [N] (constant force from graph)

f_2 = Piston rod deflection caused by lateral force [N] (reading from graph)

Calculating the mean feed force F (to DIN 69051-4)

$$F_{xm} = \sqrt[3]{\sum F_x^3 \cdot \frac{v_x}{v_{xm}} \cdot \frac{q}{100}} =$$

$$F_{xm} = \sqrt[3]{F_{x1}^3 \cdot \frac{v_{x1}}{v_{xm}} \cdot \frac{q_1}{100} + F_{x2}^3 \cdot \frac{v_{x2}}{v_{xm}} \cdot \frac{q_2}{100} + F_{x3}^3 \cdot \frac{v_{x3}}{v_{xm}} \cdot \frac{q_3}{100} + \dots}$$

The peak feed force value must not exceed the maximum feed force within a movement cycle. The peak value is generally achieved in vertical operation during the acceleration phase of the upward stroke. If the maximum feed force is exceeded, this can increase wear and thus shorten the service life of the ball screw. The maximum speed must likewise not be exceeded.

During operation, the continuous feed force may be briefly exceeded up to the maximum feed force. However, the continuous feed force must be adhered to when averaged out over a movement cycle.

Mean feed speed v (according to DIN 69051-4)

$$v_{xm} = \sum v_x \cdot \frac{q}{100} = v_{x1} \cdot \frac{q_1}{100} + v_{x2} \cdot \frac{q_2}{100} + v_{x3} \cdot \frac{q_3}{100} + \dots$$

F_x = feed force

F_{xm} = mean feed force

F_{xmax} = max. feed force

$F_{xcontinuous}$ = continuous feed force

q = time

v_x = feed speed

v_{xm} = mean feed speed

v_{xmax} = max. feed speed

Datasheet

Mean feed force F as a function of running performance L, at an operating coefficient of 1.0 and room temperature for EPCS-BS-32

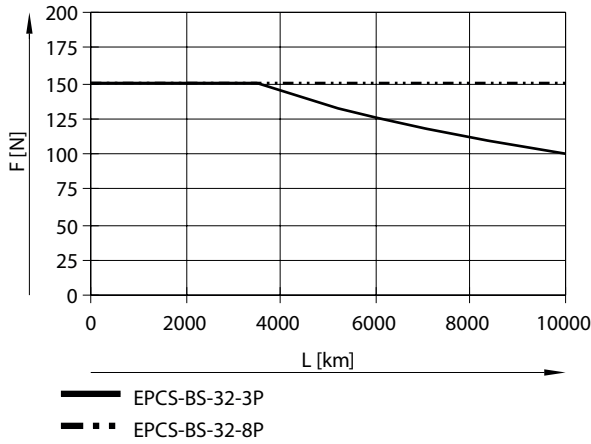

Note:
The specifications for the running performance are based on experimentally determined and theoretically calculated data (at room temperature). Under different parameters, the running performance that can be achieved in practice can deviate considerably from the specified characteristic curves.

Mean feed force F as a function of running performance L, at an operating coefficient of 1.0 and room temperature for EPCS-BS-45

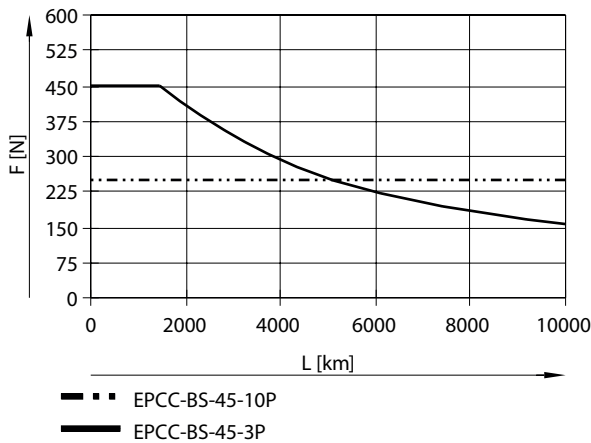

Note:
The specifications for the running performance are based on experimentally determined and theoretically calculated data (at room temperature). Under different parameters, the running performance that can be achieved in practice can deviate considerably from the specified characteristic curves.

Mean feed force F as a function of running performance L, at an operating coefficient of 1.0 and room temperature for EPCS-BS-60

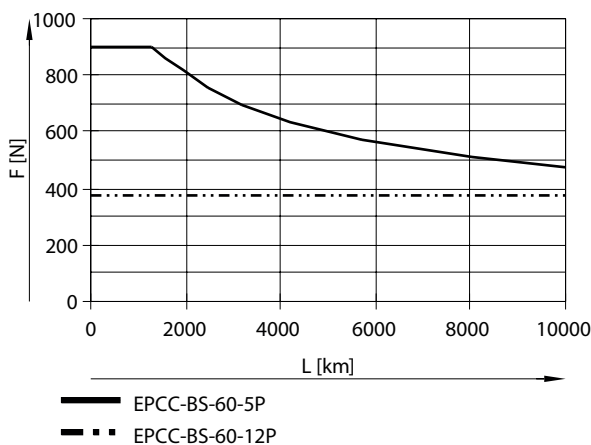

Note:
The specifications for the running performance are based on experimentally determined and theoretically calculated data (at room temperature). Under different parameters, the running performance that can be achieved in practice can deviate considerably from the specified characteristic curves.

Datasheet

Service life taking into account the operating coefficient

$$L_1 = \frac{L}{f_B^3}$$

Operating coefficient f_B

- 1.0 ... 1.2 (for measuring machine)
- 1.2 ... 1.4 (for handling technology, robotics)
- 1.4 ... 1.6 (for press-fitting operations)
- 1.6 ... 2.0 (for construction, agriculture)

L_1 = actual service life

L = target service life

f_B = operating coefficient

Sizing example

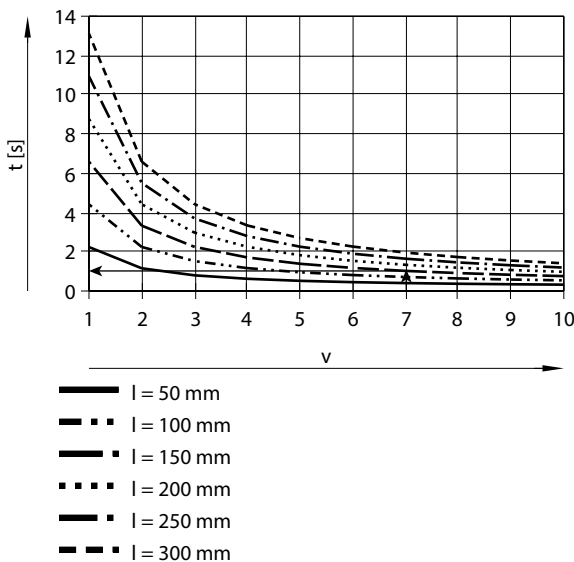
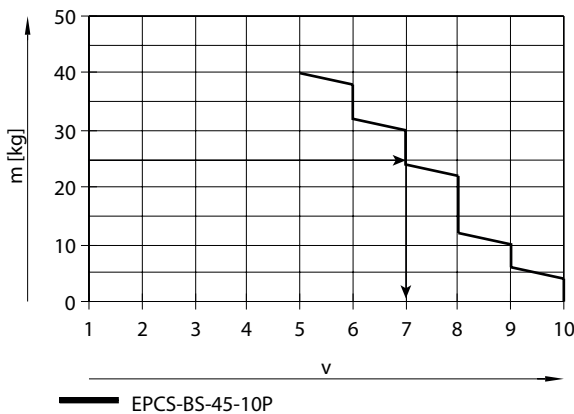

Application data:

- Payload: 25 kg
- Mounting position: horizontal
- Motor mounting position: axial
- Stroke: 150 mm
- Max. permissible positioning time: 2 s (one direction)

Step 1:

Smallest possible size from the table “Mechanical data”: EPCS-BS-45-10P

Step 2:

Selecting the max. speed level v for payload m (see diagram on the left)

Step 3:

Reading off the min. positioning time t for stroke l (see diagram on the left)

Result: The application can be realised with EPCS-BS-45-150-10P. A minimum positioning time (one direction) of 1 s is achieved.

Longer positioning times can be selected at any time using a lower speed level.

Datasheet

Mass m as a function of speed level v, with axial kit, horizontal mounting position for EPCS-BS-32-3P

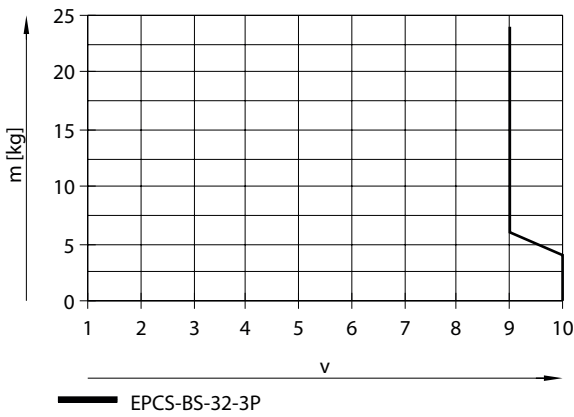

Note:
The lines represent the maximum values. The lower speed levels can be set at any time.

Mass m as a function of speed level v, with axial kit, horizontal mounting position for EPCS-BS-32-8P

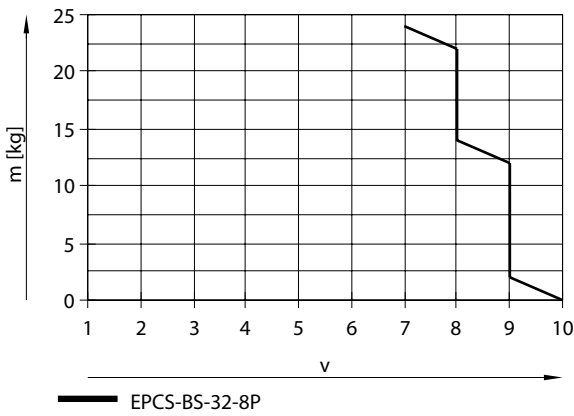

Note:
The lines represent the maximum values. The lower speed levels can be set at any time.

Mass m as a function of speed level v, with axial kit, horizontal mounting position for EPCS-BS-45-3P

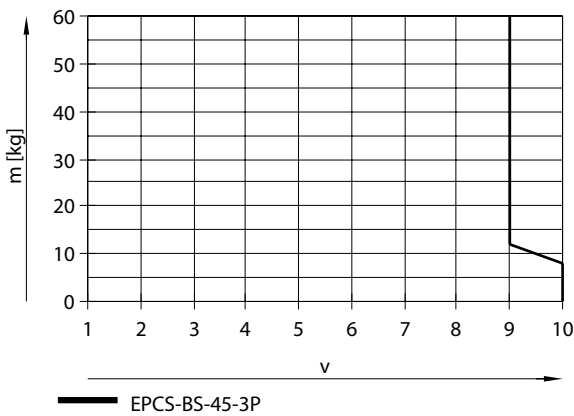

Note:
The lines represent the maximum values. The lower speed levels can be set at any time.

Datasheet

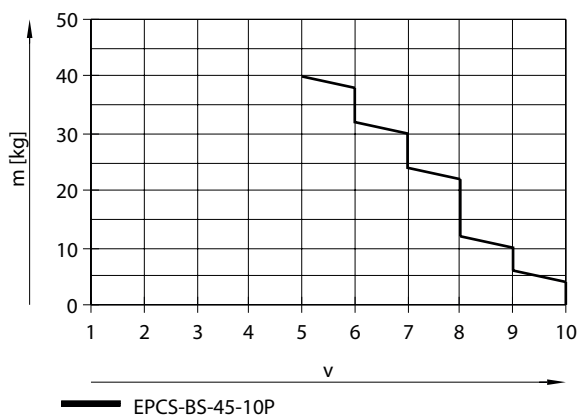
Mass m as a function of speed level v , with axial kit, horizontal mounting position for EPCS-BS-45-10P

Note:

The lines represent the maximum values. The lower speed levels can be set at any time.

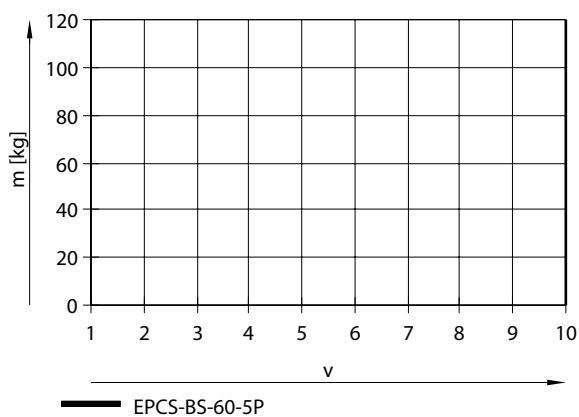
Mass m as a function of speed level v , with axial kit, horizontal mounting position for EPCS-BS-60-5P

Note:

The lines represent the maximum values. The lower speed levels can be set at any time.

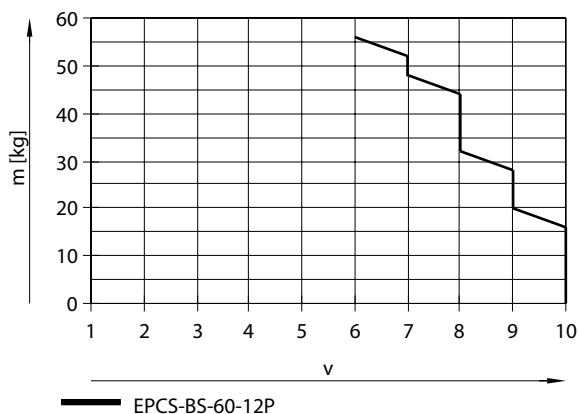
Mass m as a function of speed level v , with axial kit, horizontal mounting position for EPCS-BS-60-12P

Note:

The lines represent the maximum values. The lower speed levels can be set at any time.

Datasheet

Mass m as a function of speed level v with axial kit, vertical mounting position for EPCS-BS-32-3P

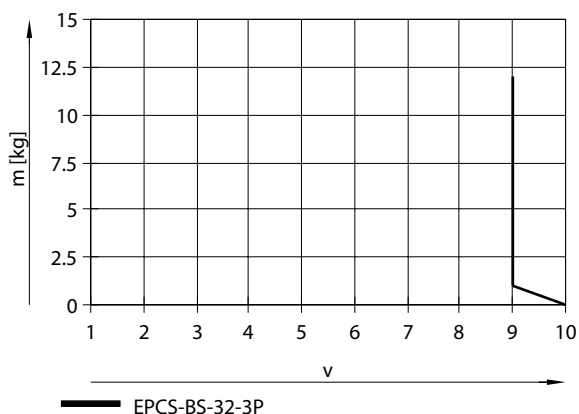

Note:
The lines represent the maximum values. The lower speed levels can be set at any time.

Mass m as a function of speed level v with axial kit, vertical mounting position for EPCS-BS-32-8P

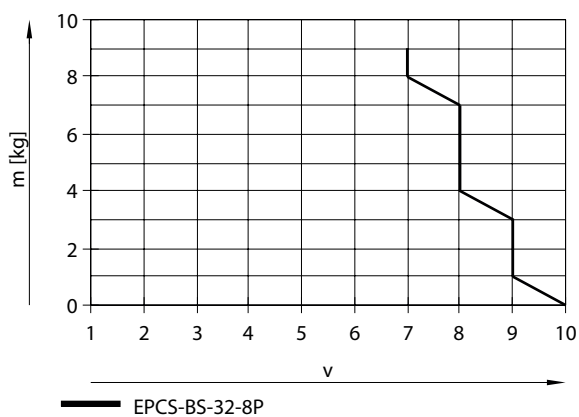

Note:
The lines represent the maximum values. The lower speed levels can be set at any time.

Mass m as a function of speed level v with axial kit, vertical mounting position for EPCS-BS-45-3P

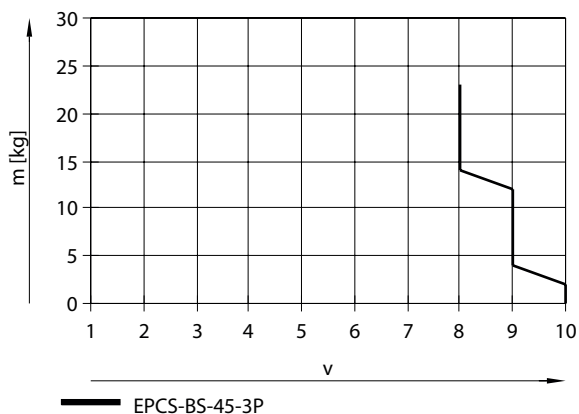

Note:
The lines represent the maximum values. The lower speed levels can be set at any time.

Datasheet

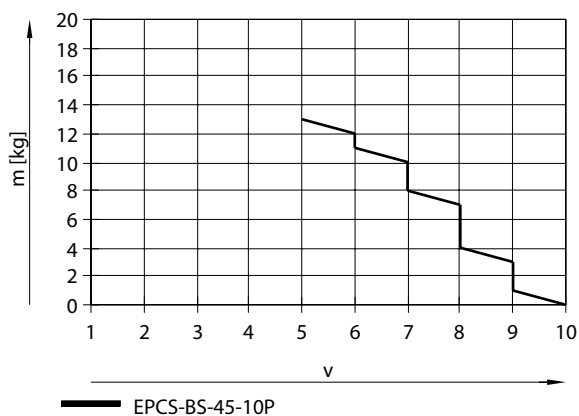
Mass m as a function of speed level v with axial kit, vertical mounting position for EPCS-BS-45-10P

Note:

The lines represent the maximum values. The lower speed levels can be set at any time.

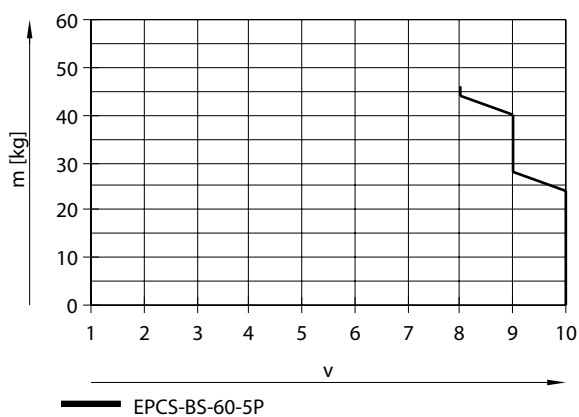
Mass m as a function of speed level v with axial kit, vertical mounting position for EPCS-BS-60-5P

Note:

The lines represent the maximum values. The lower speed levels can be set at any time.

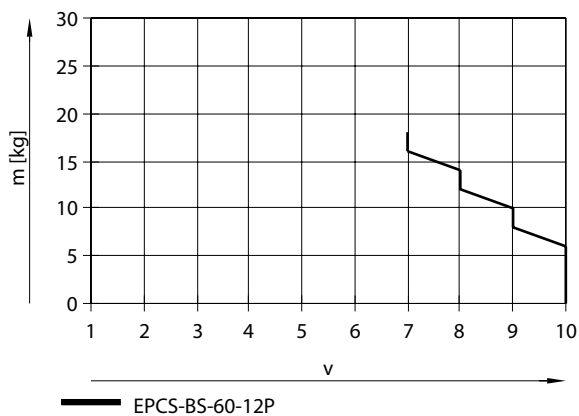
Mass m as a function of speed level v with axial kit, vertical mounting position for EPCS-BS-60-12P

Note:

The lines represent the maximum values. The lower speed levels can be set at any time.

Datasheet

Mass m as a function of speed level v with parallel kit, horizontal mounting position for EPCS-BS-32-3P

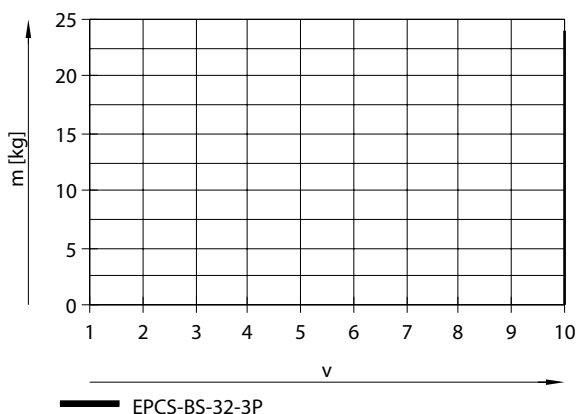

Note:
The lines represent the maximum values. The lower speed levels can be set at any time.

Mass m as a function of speed level v with parallel kit, horizontal mounting position for EPCS-BS-32-8P

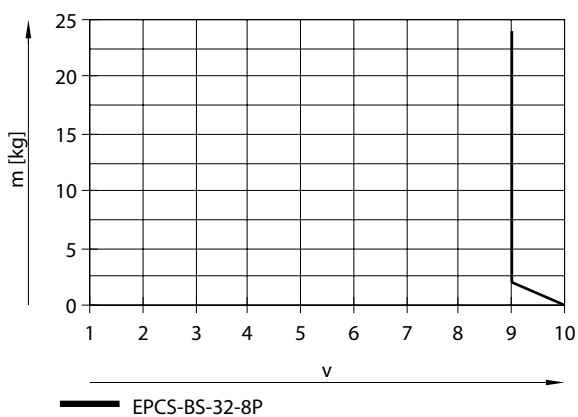

Note:
The lines represent the maximum values. The lower speed levels can be set at any time.

Mass m as a function of speed level v with parallel kit, horizontal mounting position for EPCS-BS-45-3P

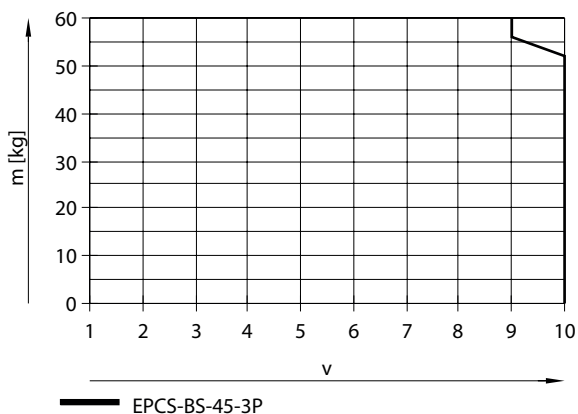

Note:
The lines represent the maximum values. The lower speed levels can be set at any time.

Datasheet

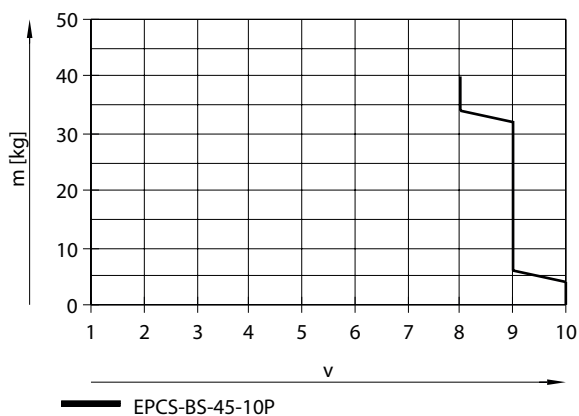
Mass m as a function of speed level v with parallel kit, horizontal mounting position for EPCS-BS-45-10P

Note:

The lines represent the maximum values. The lower speed levels can be set at any time.

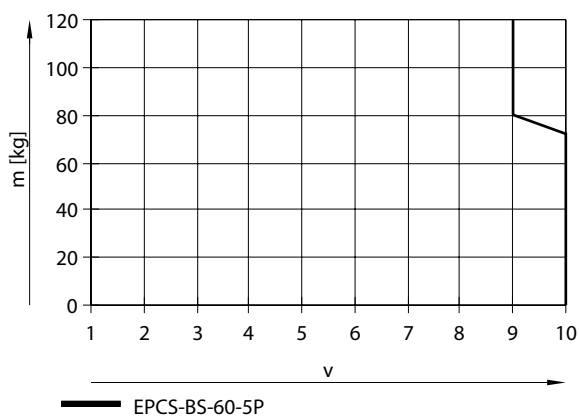
Mass m as a function of speed level v with parallel kit, horizontal mounting position for EPCS-BS-60-5P

Note:

The lines represent the maximum values. The lower speed levels can be set at any time.

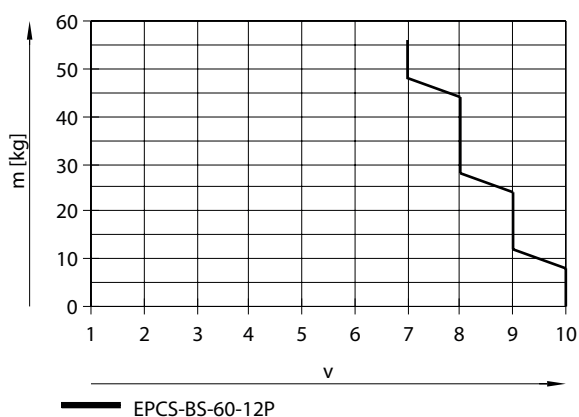
Mass m as a function of speed level v with parallel kit, horizontal mounting position for EPCS-BS-60-12P

Note:

The lines represent the maximum values. The lower speed levels can be set at any time.

Datasheet

Mass m as a function of speed level v with parallel kit, vertical mounting position for EPCS-BS-32-3P

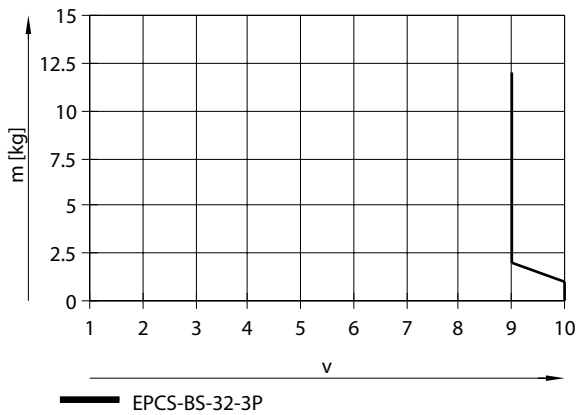

Note:

The lines represent the maximum values. The lower speed levels can be set at any time.

Mass m as a function of speed level v with parallel kit, vertical mounting position for EPCS-BS-32-8P

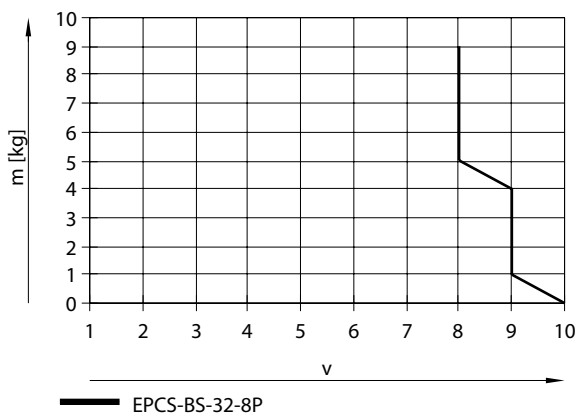

Note:

The lines represent the maximum values. The lower speed levels can be set at any time.

Mass m as a function of speed level v with parallel kit, vertical mounting position for EPCS-BS-45-3P

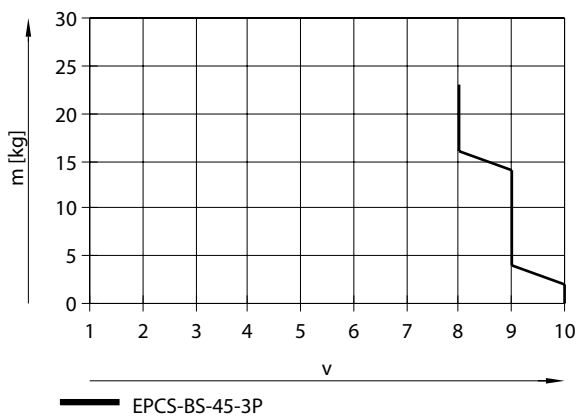

Note:

The lines represent the maximum values. The lower speed levels can be set at any time.

Datasheet

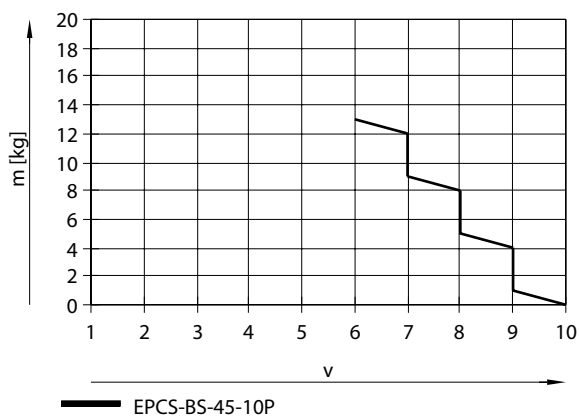
Mass m as a function of speed level v with parallel kit, vertical mounting position for EPCS-BS-45-10P

Note:

The lines represent the maximum values. The lower speed levels can be set at any time.

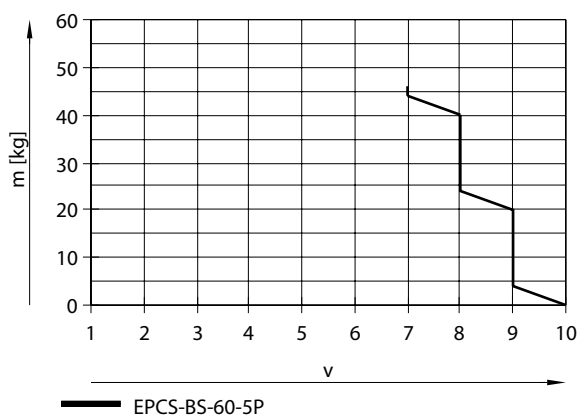
Mass m as a function of speed level v with parallel kit, vertical mounting position for EPCS-BS-60-5P

Note:

The lines represent the maximum values. The lower speed levels can be set at any time.

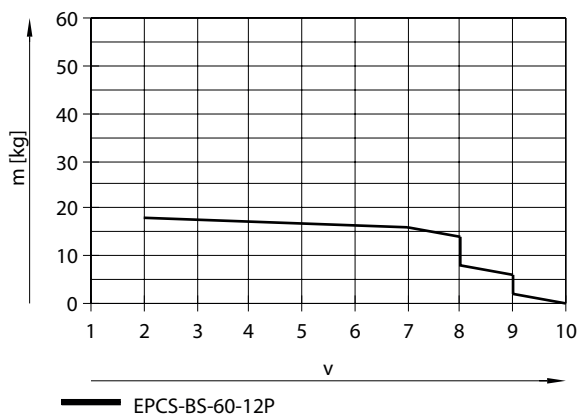
Mass m as a function of speed level v with parallel kit, vertical mounting position for EPCS-BS-60-12P

Note:

The lines represent the maximum values. The lower speed levels can be set at any time.

Datasheet

Positioning time t as a function of speed level v and stroke l with axial kit for EPCS-BS-32-3P

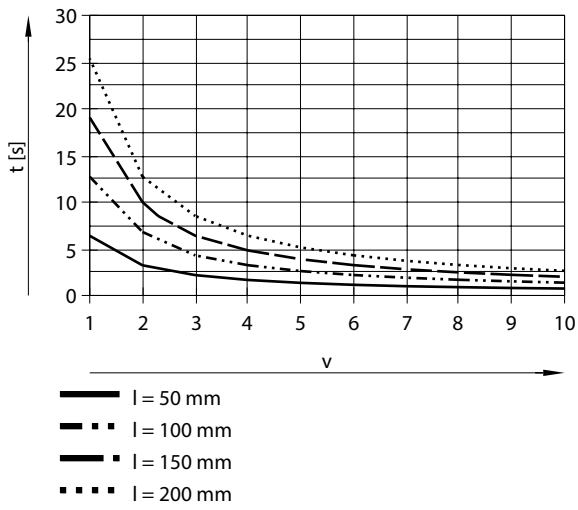

Positioning time t as a function of speed level v and stroke l with axial kit for EPCS-BS-32-8P

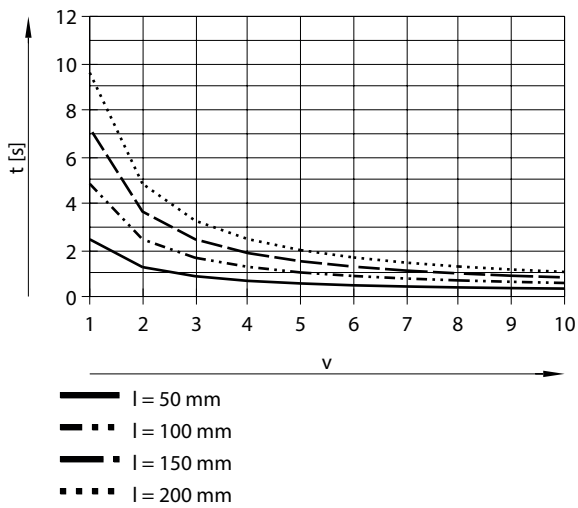

Datasheet

Positioning time t as a function of speed level v and stroke l with axial kit for EPCS-BS-45-3P

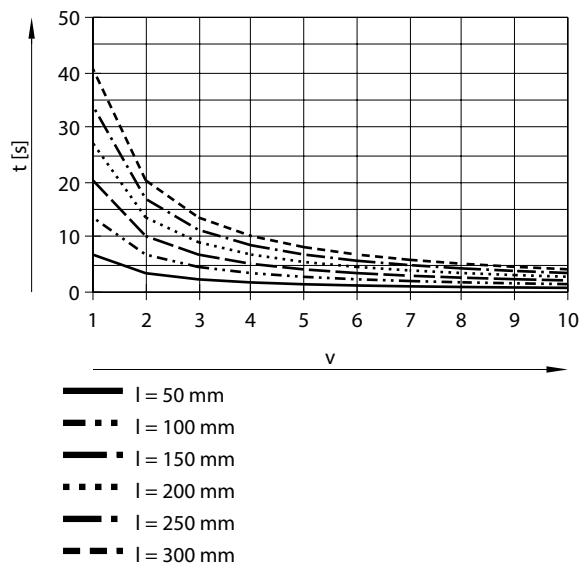

Positioning time t as a function of speed level v and stroke l with axial kit for EPCS-BS-45-10P

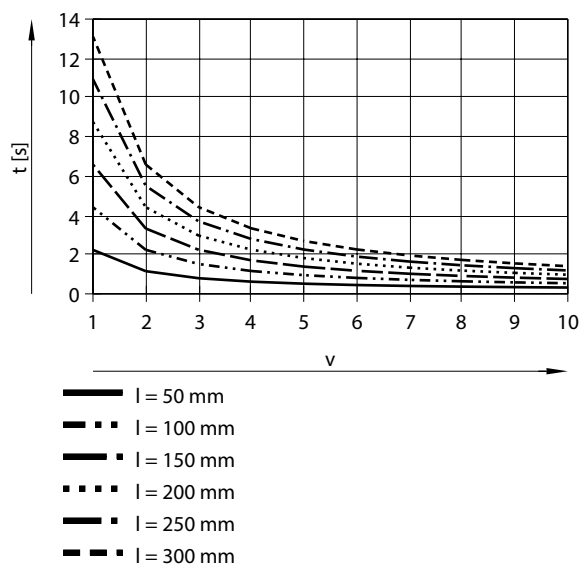

Datasheet

Positioning time t as a function of speed level v and stroke l with axial kit for EPCS-BS-60-5P

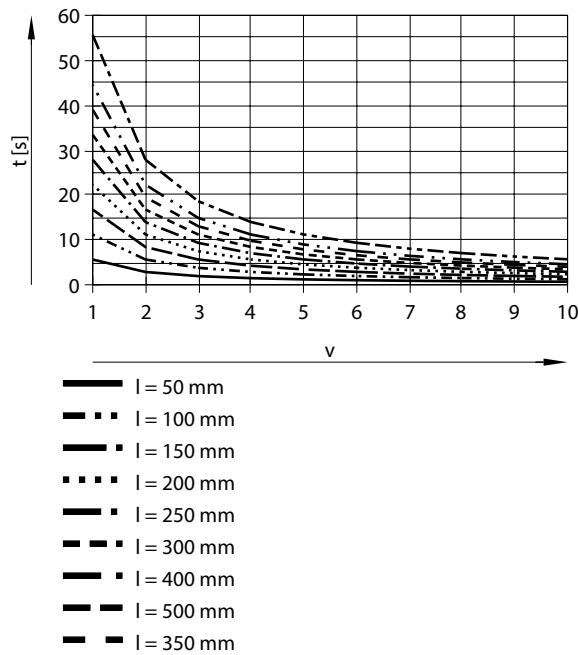

Positioning time t as a function of speed level v and stroke l with axial kit for EPCS-BS-60-12P

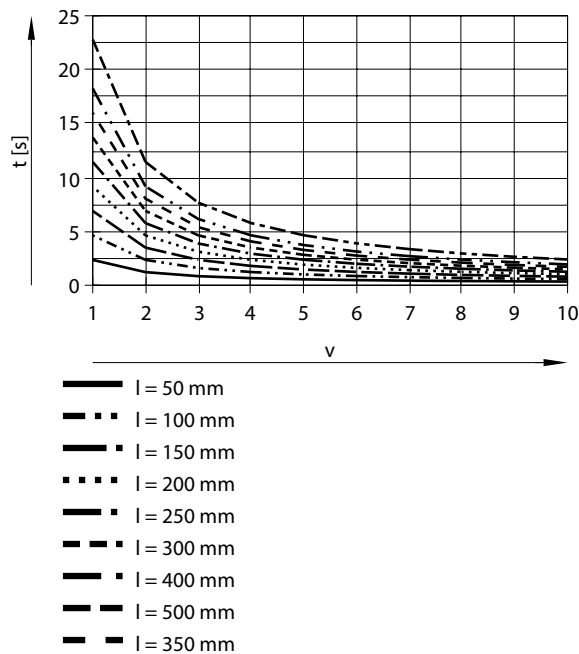

Datasheet

Positioning time t as a function of speed level v and stroke l with parallel kit for EPCS-BS-32-3P

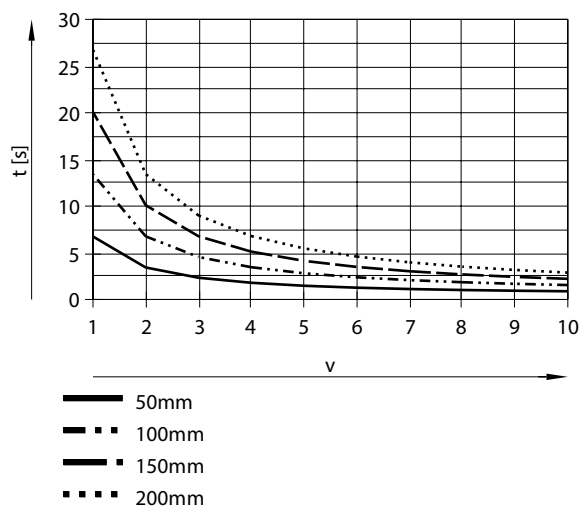

Positioning time t as a function of speed level v and stroke l with parallel kit for EPCS-BS-32-8P

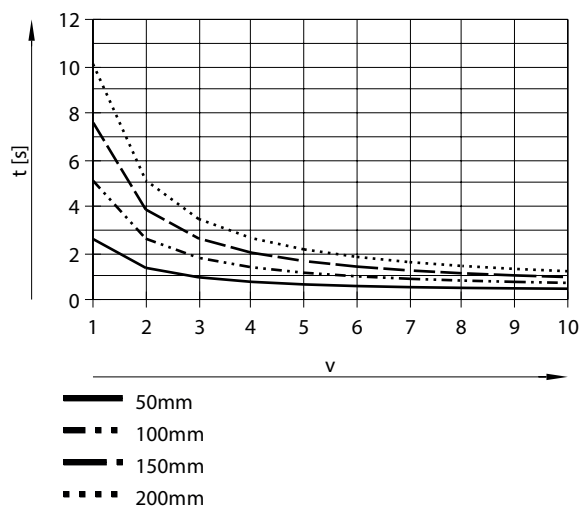

Datasheet

Positioning time t as a function of speed level v and stroke l with parallel kit for EPCS-BS-45-3P

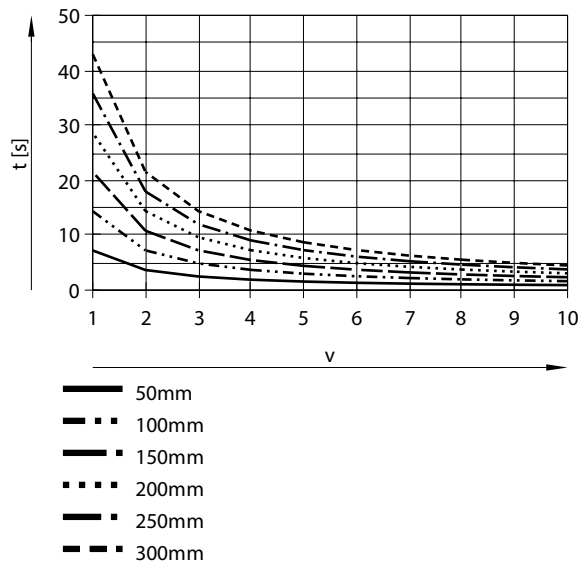

Positioning time t as a function of speed level v and stroke l with parallel kit for EPCS-BS-45-10P

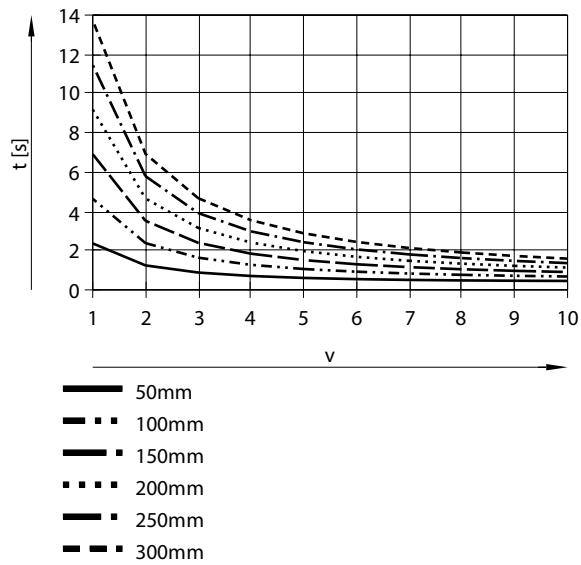

Datasheet

Positioning time t as a function of speed level v and stroke l with parallel kit for EPCS-BS-60-5P

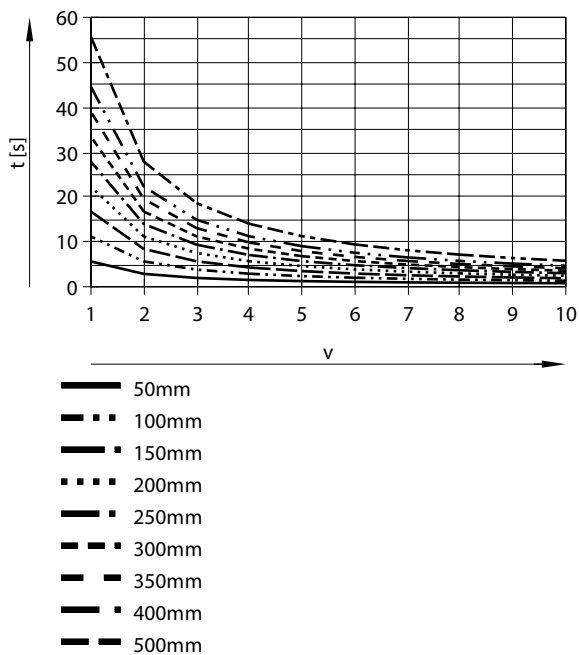

Positioning time t as a function of speed level v and stroke l with parallel kit for EPCS-BS-60-12P

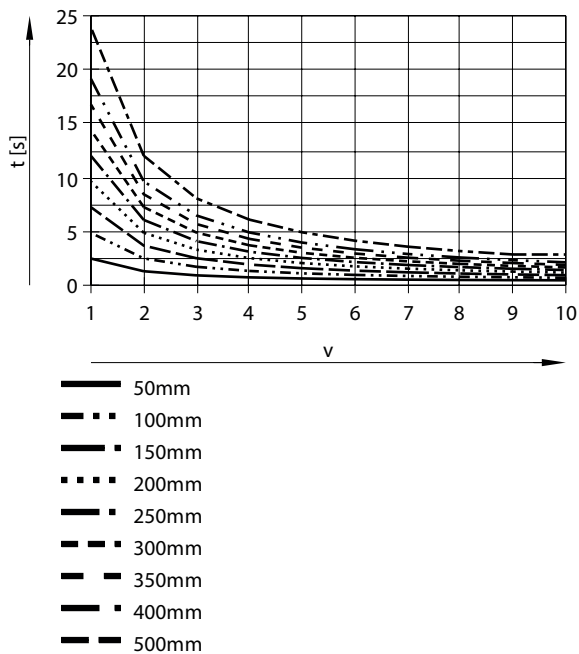

Datasheet

Feed force F as a function of force level F1

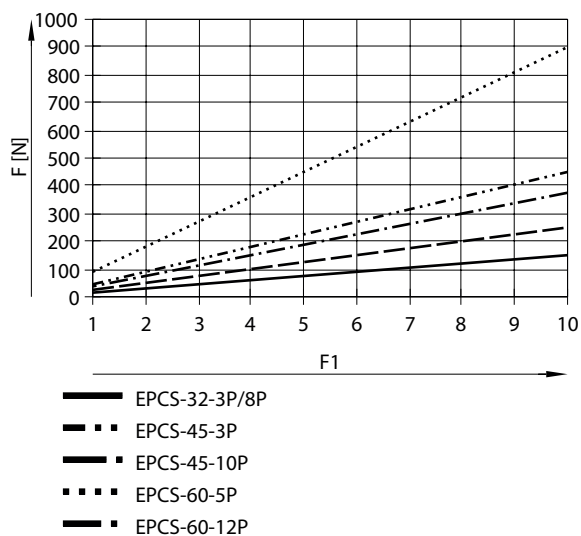

Combinations between axis ELGC, ELGS, mini slide EGSC-BS, EGSS-BS, electric cylinder EPCC, EPCS and guide axis ELFC

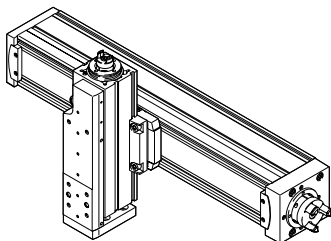

Mounting options with profile mounting EAHF-L2-...-P-D

- Mounting option: base axis with one-size-down assembly axis

1. Base axis:
Product: ELGC, ELGS, ELFC
Size 32, 45, 60, 80
2. Assembly axis:
Product: ELGC, ELGS, EGSC, EGSS, EPCC, EPCS, ELFC
Size 25, 32, 45, 60

Combinations between axis ELGC, ELGS, mini slide EGSC-BS, EGSS-BS, electric cylinder EPCC, EPCS and guide axis ELFC

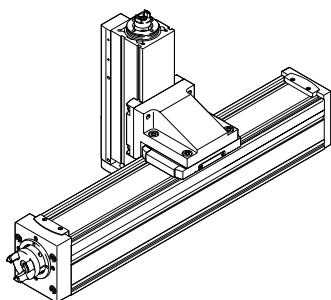

Mounting options with angle kit EHAA-D-L2-...-AP

- Mounting option: base axis with one-size-down assembly axis

1. Base axis:
Product: ELGC, ELGS, ELFC
Size 32, 45, 60, 80
2. Assembly axis:
Product: ELGC, ELGS, EGSC, EGSS, EPCC, EPCS, ELFC
Size 25, 32, 45, 60

Datasheet

Combinations between axis ELGC, ELGS, mini slide EGSC-BS, EGSS-BS, electric cylinder EPCC, EPCS and guide axis ELFC

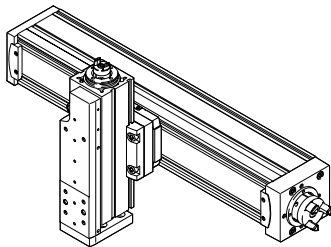

Mounting options with adapter kit EHAA-D-L2

- Mounting option: base axis with same size assembly axis
- Mounting option: base axis with height compensation for one-size-down assembly axis
- When motors are mounted using parallel kits, this may lead to interfering contours. In this case, the adapter plate is required for height compensation

1. Base axis:

Product: ELGC, ELGS, ELFC

Size 32, 45, 60, 80

2. Assembly axis:

Product: ELGC, ELGS, EGSC, EGSS, EPCC, EPCS, ELFC

Size 25, 32, 45, 60, 80

Combinations between mini slides EGSC-BS, EGSS-BS

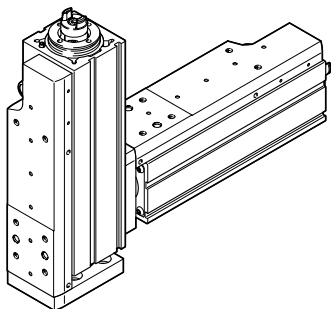

Mounting options with direct fastening

- Mounting option: base axis with same size assembly axis

1. Base axis:

Product: EGSC, EGSS

Size 25, 32, 45, 60

2. Assembly axis:

Product: EGSC, EGSS

Size 25, 32, 45, 60

Dimensions

Dimensions – With axial motor mounting

Download CAD data → www.festo.com

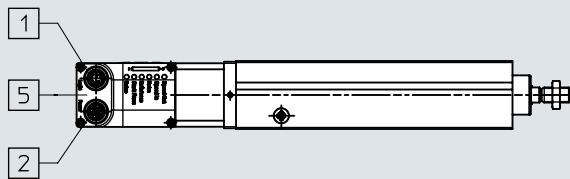
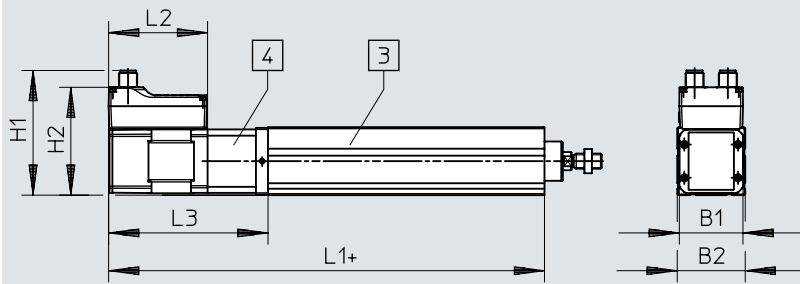

- [1] Connection to logic interface
- [2] Connection to power supply
- [3] Electric cylinder
- [4] Axial kit
- [5] Motor
- [6] + = plus stroke length

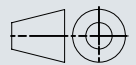

	B1	B2	H1	H2	L1	L2	L3
EPCS-BS-32	42,3	32	81,1	69,9	175,5	65,5	105,5
EPCS-BS-45	42,3	45	82,6	71,4	188,5	65,5	105,5
EPCS-BS-60	56,6	60	97,3	86,1	216,5	73,5	116,5

Dimensions

Dimensions – With parallel motor mounting

Download CAD data → www.festo.com

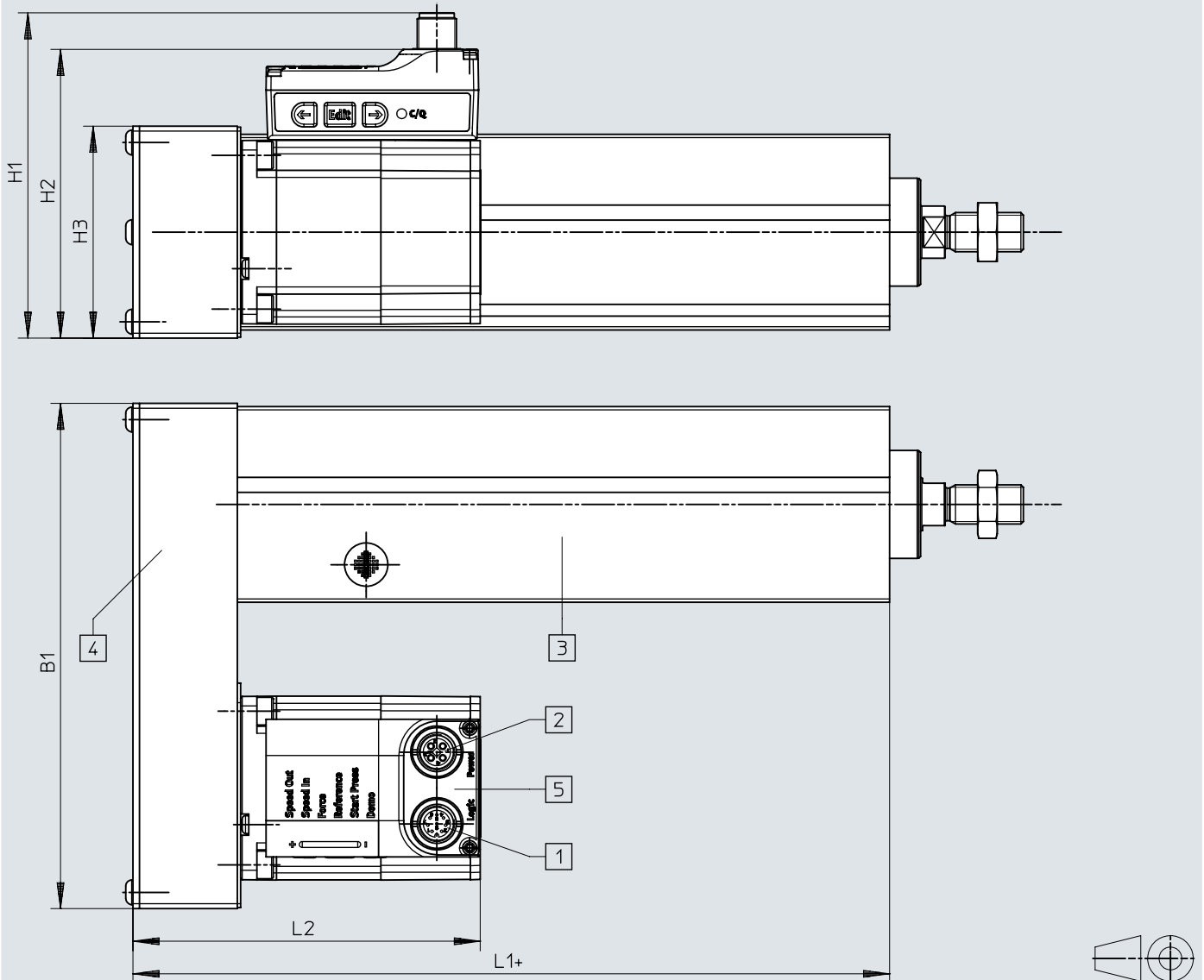

- [1] Connection to logic interface
- [2] Connection to power supply
- [3] Electric cylinder
- [4] Parallel kit
- [5] Motor
- [6] + = plus stroke length

	B1	H1	H2	H3	L1	L2
EPCS-BS-32	111	83	72	45	94	90,7
EPCS-BS-45	111	83	72	45	107	90,7
EPCS-BS-60	155	100	90	65	132	107,7

Dimensions

Dimensions – Mechanics

Download CAD data → www.festo.com

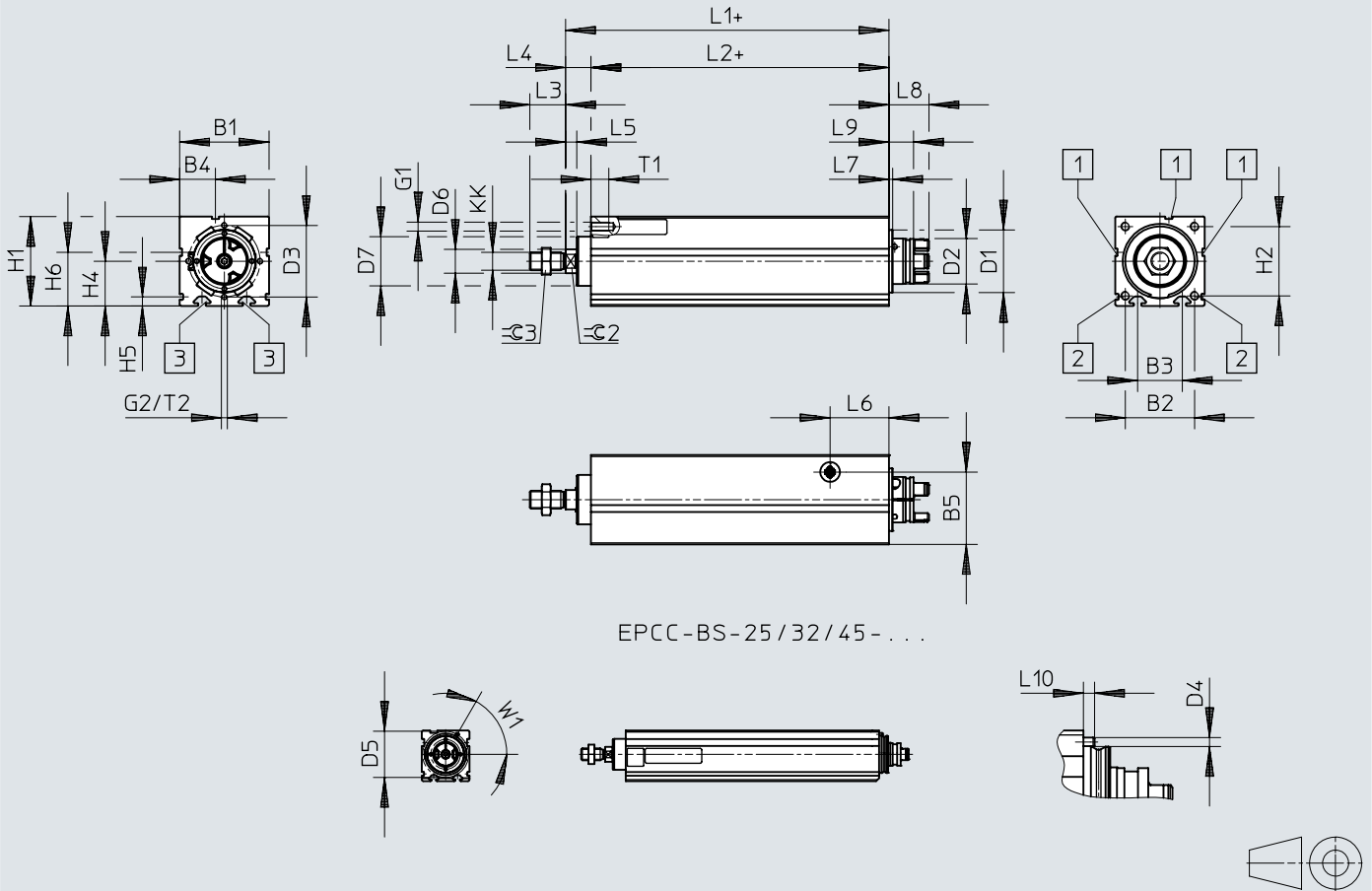

- [1] For sensor bracket
- [2] For profile mounting
- [3] For slot nut mounting
- [4] + = plus stroke length
- [5] Orientation of the spanner flat 2 is not clear

Dimensions

	B1 ±0,15	B2	B3	B4	B5	D1 ∅	D2 ∅	D3 ∅	D4 ∅
EPCS-BS-32	32	24	16	8,1	25,5	25	15,5	–	2
EPCS-BS-45	45	32,5	24	16,5	35	32	16,3	–	3
EPCS-BS-60	60	46,5	30	24	48,5	42	31,4	48	–

	D5 ∅	D6 ∅	D7 ∅	G1	G2	H1 ±0,15	H2	H4	H5
EPCS-BS-32	31	10	21,3	M4	–	34	24	–	4,9
EPCS-BS-45	41	12	26,5	M5	–	45	32,5	–	6,1
EPCS-BS-60	–	16	33,6	M6	M4	60	46,5	30	6,1

	H6 ±0,15	KK	L1	L2	L3	L4	L5	L6	L7
EPCS-BS-32	26	M8	82,9	70	16	12,9	5,2	24,2	6
EPCS-BS-45	28,5	M10x1,25	99,9	83	20	16,9	5,7	30,5	6
EPCS-BS-60	36	M12x1,25	116	100	24	16	7,5	39,5	2,5

	L8	L9	L10	T1	T2	W1	≈G2	≈G3
EPCS-BS-32	19,9	14,5	2,5	8	–	60°	9	13
EPCS-BS-45	19,9	14,5	3	10	–	60°	10	16
EPCS-BS-60	26,9	16,5	–	12	10	–	13	18

Dimensions

Dimensions – Profile mounting EAHF-L2-...-P-S

Download CAD data → www.festo.com

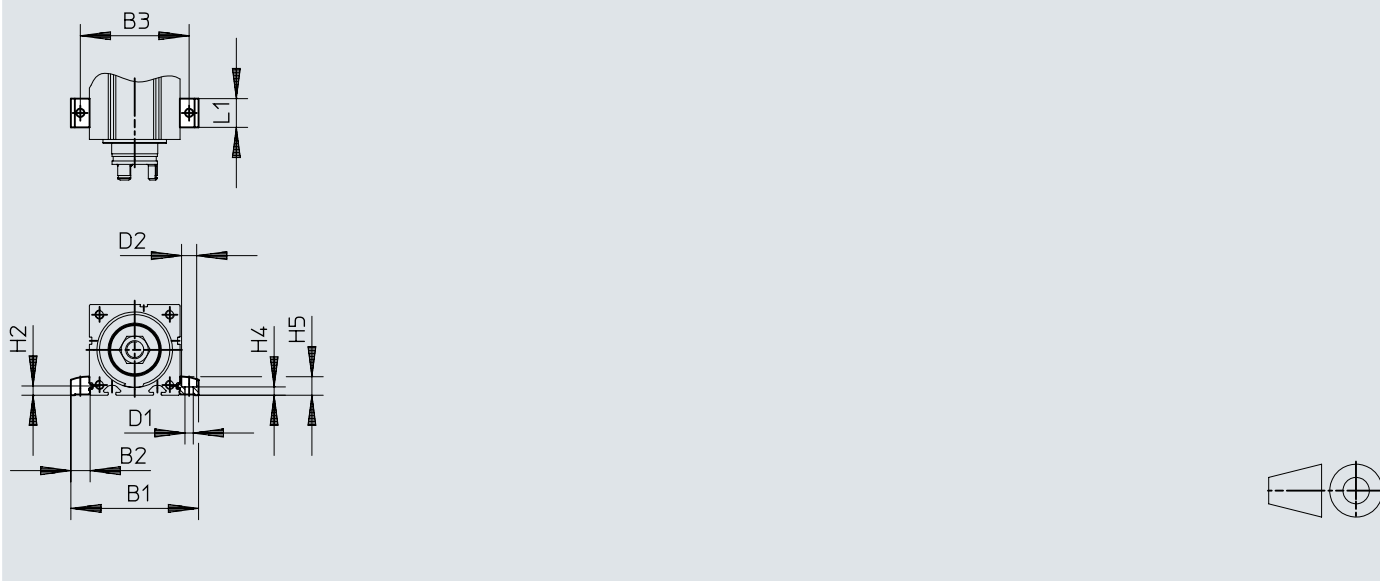

		B1	B2	B3	D1 ∅ H13	D2 ∅ H13	H2	H4 ±0,1	H5	L1
EAHF-L2-25-P-S	EPCS-BS-32	51,4	9,7	42	4,5	8	4,9	4,2	9	19
EAHF-L2-45-P-S	EPCS-BS-45	70,6	12,8	58	5,5	10	6,1	5,5	12,2	19
EAHF-L2-45-P-S	EPCS-BS-60	85,6	12,8	73	5,5	10	6,1	5,5	12,2	19

Dimensions

Dimensions – Profile mounting EAHF-L2-...-P

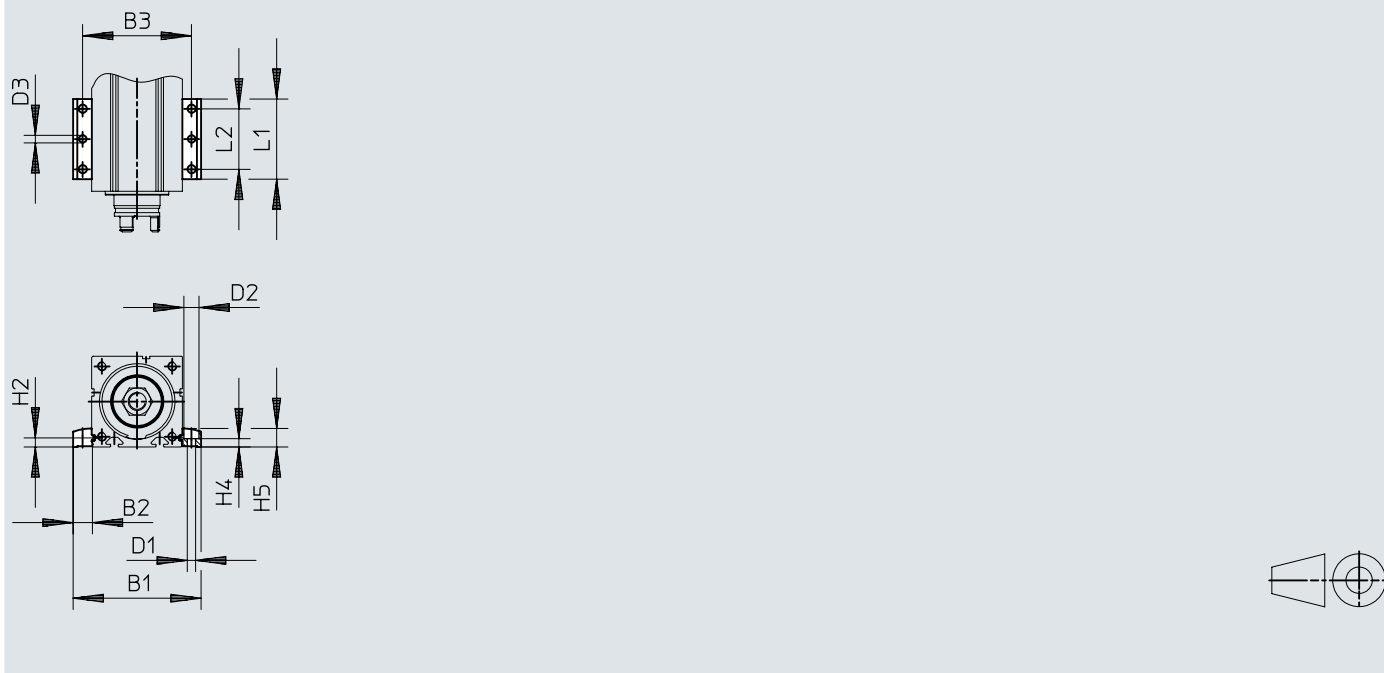
Download CAD data → www.festo.com

		B1	B2	B3	D1 ∅ H13	D2 ∅ H13	D3 ∅	H2	H4 ±0,1	H5	L1	L2
EAHF-L2-25-P	EPCS-BS-32	51,4	9,7	42	4,5	8	4	4,9	4,2	9	53	40
EAHF-L2-45-P	EPCS-BS-45	70,6	12,8	58	5,5	10	5	6,1	5,5	12,2	53	40
EAHF-L2-45-P	EPCS-BS-60	85,6	12,8	73	5,5	10	5	6,1	5,5	12,2	53	40

Dimensions

Dimensions – Flange mounting EAHH

Download CAD data → www.festo.com

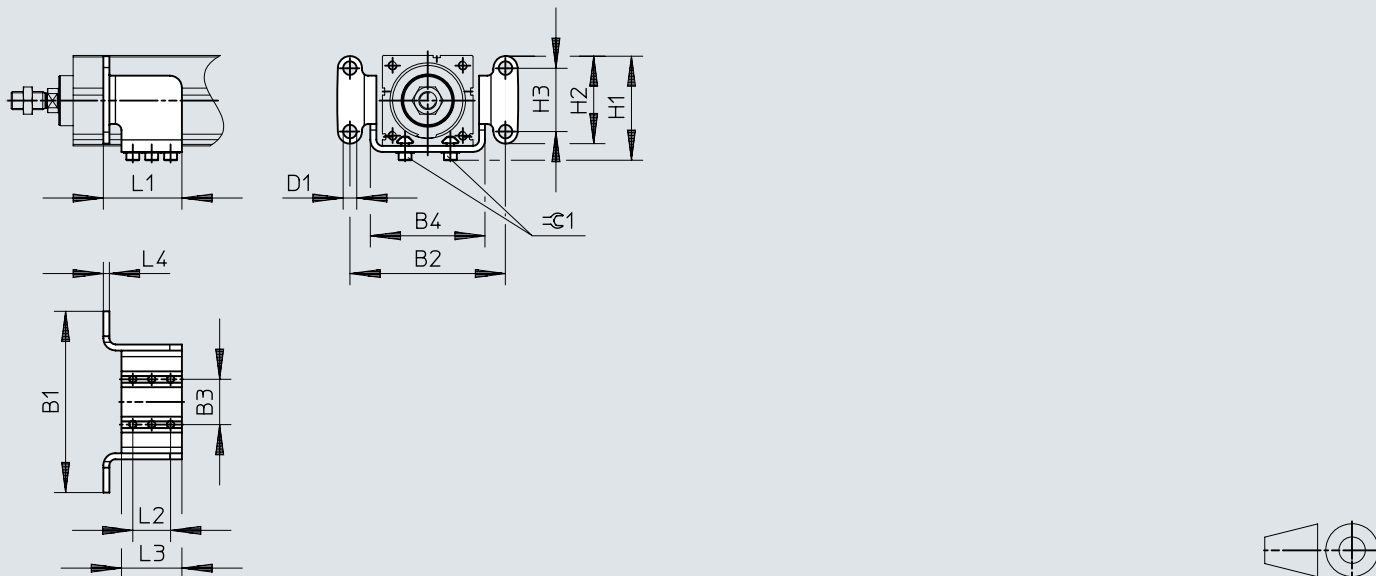

[1] The position is freely selectable along the entire cylinder length.

	B1	B2	B3 ±0,1	B4	D1 ∅	H1	H2	H3	L1	L2	L3	L4	⊙1
EAHH-P2-32	70	58	16	42	5,5	39	31	20	38	20	30	2,5	2,5
EAHH-P2-45	100	85	24	61	6,6	54,5	48	35	42	20	30	4	2,5
EAHH-P2-60	120	103	30	76	9	69	58	42	52	25	40	4	4

Dimensions

Dimensions – Adapter kit EAHA

Download CAD data → www.festo.com

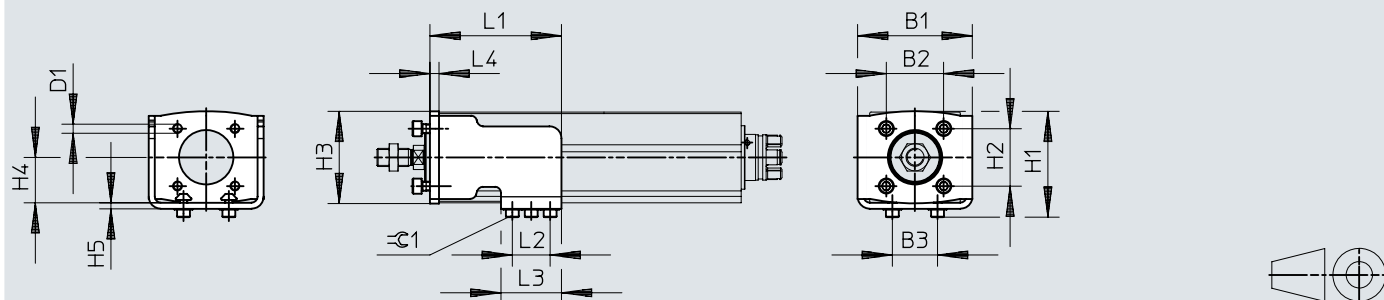

	B1	B2	B3	D1 ∅	H1	H2	H3	H4	H5	L1	L2	L3	L4	rC1
		±0,2	±0,1			±0,2								
EAHA-P2-32	53	22	16	M5	42	22	37	18	2,5	64	20	30	4	2,5
EAHA-P2-45	61	32,5	24	M6	54	32,5	49	22,5	4	68	20	30	6	2,5
EAHA-P2-60	76	38	30	M6	69,5	38	61	30	4	87	25	40	6	4

Dimensions

Dimensions – Swivel mounting EAHS

Download CAD data → www.festo.com

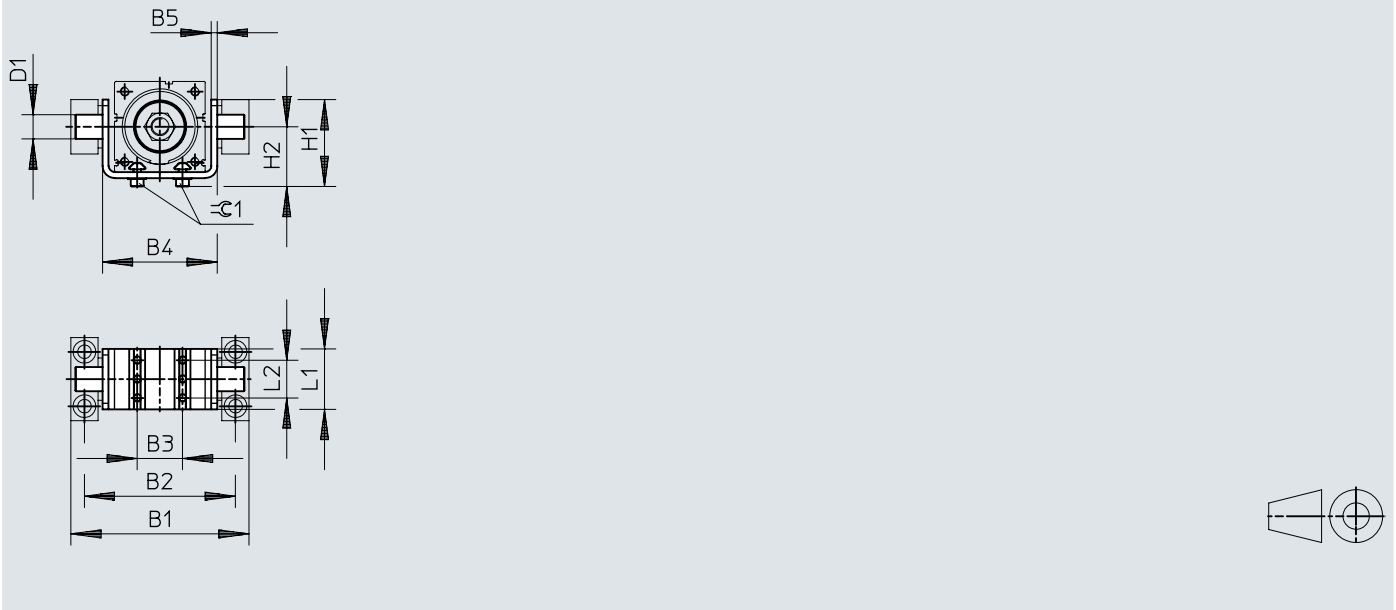

	B1	B2	B3 ±0,1	B4	B5	D1 ∅ e9	H1	H2	L1	L2	±0,1
EAHS-P2-32	68	57	16	42	2,5	8	32	23,5	30	20	2,5
EAHS-P2-45	98	83	24	62	4	12	44,5	29,5	30	20	2,5
EAHS-P2-60	118	100	30	76	4	16	57	39	40	25	4

Dimensions

Dimensions – Trunnion support LNZG

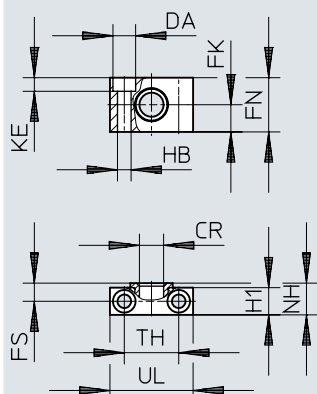
Download CAD data → www.festo.com

		CR ∅ D11	DA ∅ H13	FK ∅ ±0,1	FN	FS	H1	HB ∅ H13	KE	NH	TH ±0,2	UL
LNZG-16	EPCS-BS-32	8	8	10	20	7,5	11	4,5	4,6	13	20	30
LNZG-32	EPCS-BS-45	12	11	15	30	10,5	15	6,6	6,8	18	32	46
LNZG-40/50	EPCS-BS-60	16	15	18	36	12	18	9	9	21	36	55

Dimensions

Dimensions – Swivel flange SNCS

Download CAD data → www.festo.com

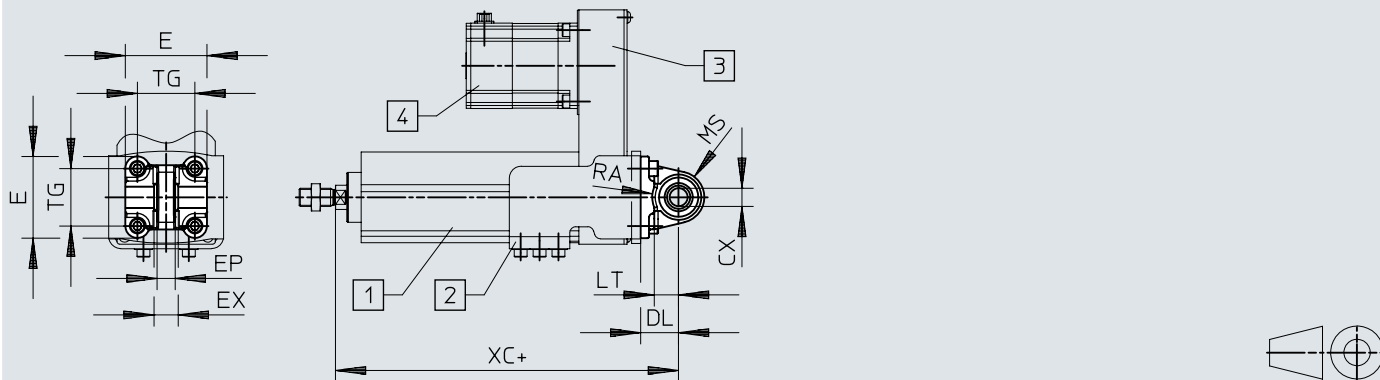

- [1] Electric cylinder unit EPCS
- [2] Adapter kit EAHA
- [3] Motor mounting kit EAMM-U
- [4] Motor
- [5] + = plus stroke length

		CX	DL	E	L	EP	EX	LT	MS	RA	TG	XC
			±0,2			±0,2						
SNCS-32	EPCS-BS-45	10 ^{+0,13}	22	45 ^{+0,2/-0,5}	3	10,5	14	13	15	14,5	32,5	154,9
SNCS-40	EPCS-BS-60	12 ^{+0,15}	25	54 _{-0,5}	3	12	16	16	17	17,5	38	182

Dimensions

Dimensions – Swivel flange SNCL

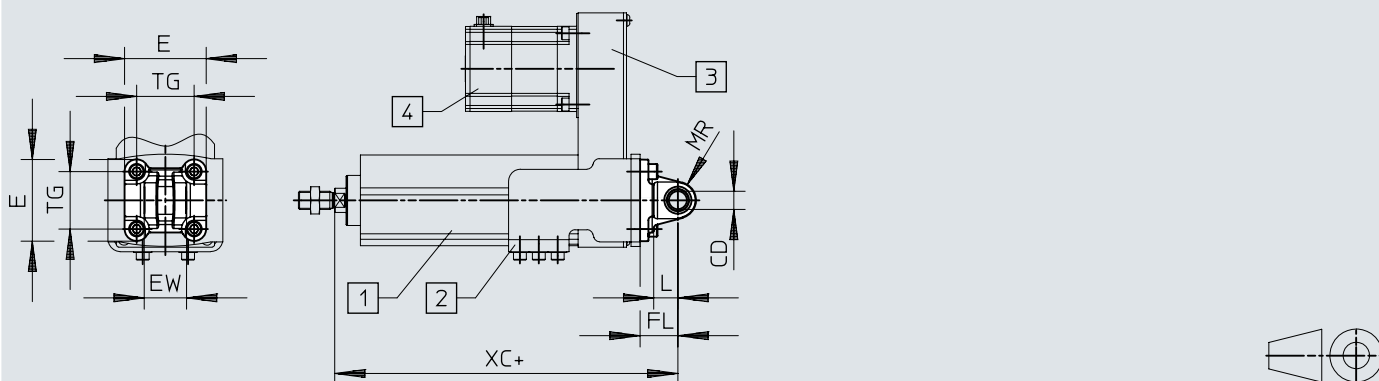
Download CAD data → www.festo.com

- [1] Electric cylinder unit EPCS
 [2] Adapter kit EAHA
 [3] Motor mounting kit EAMM-U
 [4] Motor
 [5] + = plus stroke length

		CD ∅ H10	E	EW h12	FL ±0,2	L	LT	MR	TG	XC
SNCL-16	EPCS-BS-25	6	27,5 _{-0,6}	12 _{h12}	16	3	10	6	18	115,7
SNCL-20	EPCS-BS-32	8	34,5 _{-0,6}	16 _{h12}	20	3	14	8	22	133,9
SNCL-32	EPCS-BS-45	10	45 _{+0,2/-0,5}	26 _{-0,2/-0,6}	22	3	13	10	32,5	154,9
SNCL-40	EPCS-BS-60	12	54 _{-0,5}	28 _{-0,2/-0,6}	25	3	16	12	38	182

Dimensions

Dimensions – Swivel flange SNCB

Download CAD data → www.festo.com

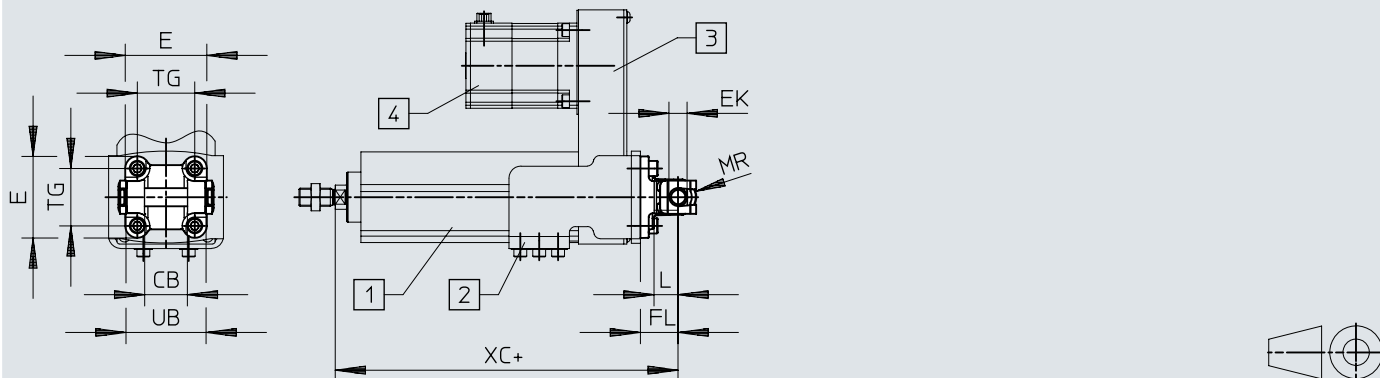

- [1] Electric cylinder unit EPCS
- [2] Adapter kit EAHA
- [3] Motor mounting kit EAMM-U
- [4] Motor
- [5] + = plus stroke length

		CB	E	EK ∅	FL	L	LT	MR	TG	UB	XC
		H14		H10/e8	±0,2			-0,5		h14	
SNCB-32	EPCS-BS-45	26	45+0,2/-0,5	10	22	3	13	8,5	32,5	45	154,9
SNCB-40	EPCS-BS-60	28	54-0,5	12	25	3	16	12	38	52	182

Dimensions

Dimensions – Sensor bracket EAPM-L2

Download CAD data → www.festo.com

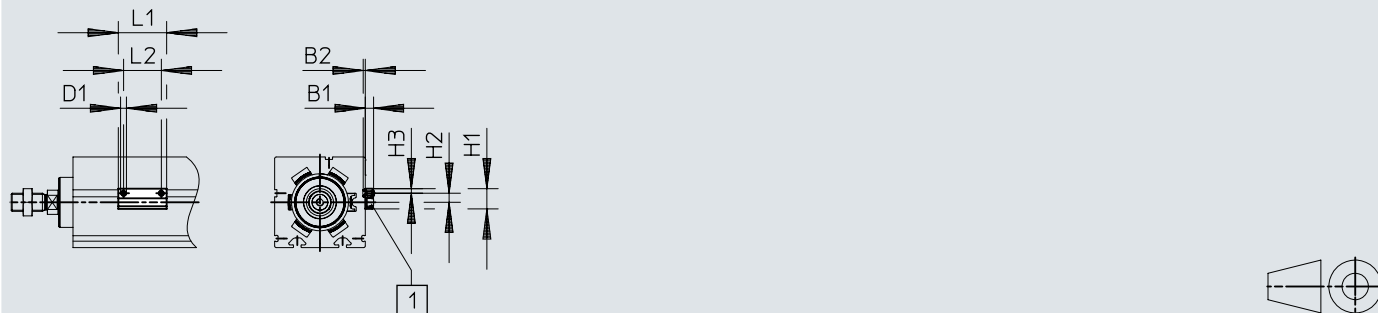

[1] Proximity switch

	B1	B2	D1	H1	H2	H3	L1	L2
EAPM-L2-SH	5,5	1,3	M4	13,4	6	3	32	25

Ordering data

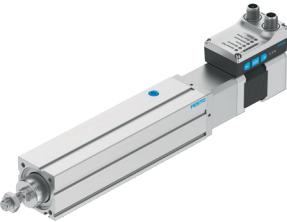
Ordering data							
	Size	Spindle pitch	Stroke	Part no.	Type		
	32	3 mm/U	50 mm	8118267	EPCS-BS-32-50-3P-A-ST-M-H1-PLK-AA		
			100 mm	8118268	EPCS-BS-32-100-3P-A-ST-M-H1-PLK-AA		
			150 mm	8118269	EPCS-BS-32-150-3P-A-ST-M-H1-PLK-AA		
			200 mm	8118270	EPCS-BS-32-200-3P-A-ST-M-H1-PLK-AA		
		8 mm/U	50 mm	8118271	EPCS-BS-32-50-8P-A-ST-M-H1-PLK-AA		
			100 mm	8118272	EPCS-BS-32-100-8P-A-ST-M-H1-PLK-AA		
			150 mm	8118273	EPCS-BS-32-150-8P-A-ST-M-H1-PLK-AA		
			200 mm	8118274	EPCS-BS-32-200-8P-A-ST-M-H1-PLK-AA		
	45	3 mm/U	50 mm	8118275	EPCS-BS-45-50-3P-A-ST-M-H1-PLK-AA		
			100 mm	8118276	EPCS-BS-45-100-3P-A-ST-M-H1-PLK-AA		
			150 mm	8118277	EPCS-BS-45-150-3P-A-ST-M-H1-PLK-AA		
			200 mm	8118278	EPCS-BS-45-200-3P-A-ST-M-H1-PLK-AA		
			250 mm	8118279	EPCS-BS-45-250-3P-A-ST-M-H1-PLK-AA		
			300 mm	8118280	EPCS-BS-45-300-3P-A-ST-M-H1-PLK-AA		
		10 mm/U	50 mm	8118281	EPCS-BS-45-50-10P-A-ST-M-H1-PLK-AA		
			100 mm	8118282	EPCS-BS-45-100-10P-A-ST-M-H1-PLK-AA		
			150 mm	8118283	EPCS-BS-45-150-10P-A-ST-M-H1-PLK-AA		
			200 mm	8118284	EPCS-BS-45-200-10P-A-ST-M-H1-PLK-AA		
			250 mm	8118285	EPCS-BS-45-250-10P-A-ST-M-H1-PLK-AA		
			300 mm	8118286	EPCS-BS-45-300-10P-A-ST-M-H1-PLK-AA		
			60	5 mm/U	50 mm	8118287	EPCS-BS-60-50-5P-A-ST-M-H1-PLK-AA
					100 mm	8118288	EPCS-BS-60-100-5P-A-ST-M-H1-PLK-AA
	150 mm	8118289			EPCS-BS-60-150-5P-A-ST-M-H1-PLK-AA		
	200 mm	8118290			EPCS-BS-60-200-5P-A-ST-M-H1-PLK-AA		
250 mm	8118291	EPCS-BS-60-250-5P-A-ST-M-H1-PLK-AA					
300 mm	8118292	EPCS-BS-60-300-5P-A-ST-M-H1-PLK-AA					
350 mm	8118293	EPCS-BS-60-350-5P-A-ST-M-H1-PLK-AA					
400 mm	8118294	EPCS-BS-60-400-5P-A-ST-M-H1-PLK-AA					
12 mm/U	50 mm	8118296	EPCS-BS-60-50-12P-A-ST-M-H1-PLK-AA				
	100 mm	8118297	EPCS-BS-60-100-12P-A-ST-M-H1-PLK-AA				
	150 mm	8118298	EPCS-BS-60-150-12P-A-ST-M-H1-PLK-AA				
	200 mm	8118299	EPCS-BS-60-200-12P-A-ST-M-H1-PLK-AA				
	250 mm	8118300	EPCS-BS-60-250-12P-A-ST-M-H1-PLK-AA				
	300 mm	8118301	EPCS-BS-60-300-12P-A-ST-M-H1-PLK-AA				
	350 mm	8118302	EPCS-BS-60-350-12P-A-ST-M-H1-PLK-AA				
	400 mm	8118303	EPCS-BS-60-400-12P-A-ST-M-H1-PLK-AA				
		500 mm	8118304	EPCS-BS-60-500-12P-A-ST-M-H1-PLK-AA			

Ordering information – Modular product system				Further information → epcs
	Size	Stroke	Part no.	Type
	32	25 ... 200 mm	8118264	EPCS-BS-32-
	45	25 ... 300 mm	8118265	EPCS-BS-45-
	60	25 ... 500 mm	8118266	EPCS-BS-60-

Peripherals

Peripherals overview

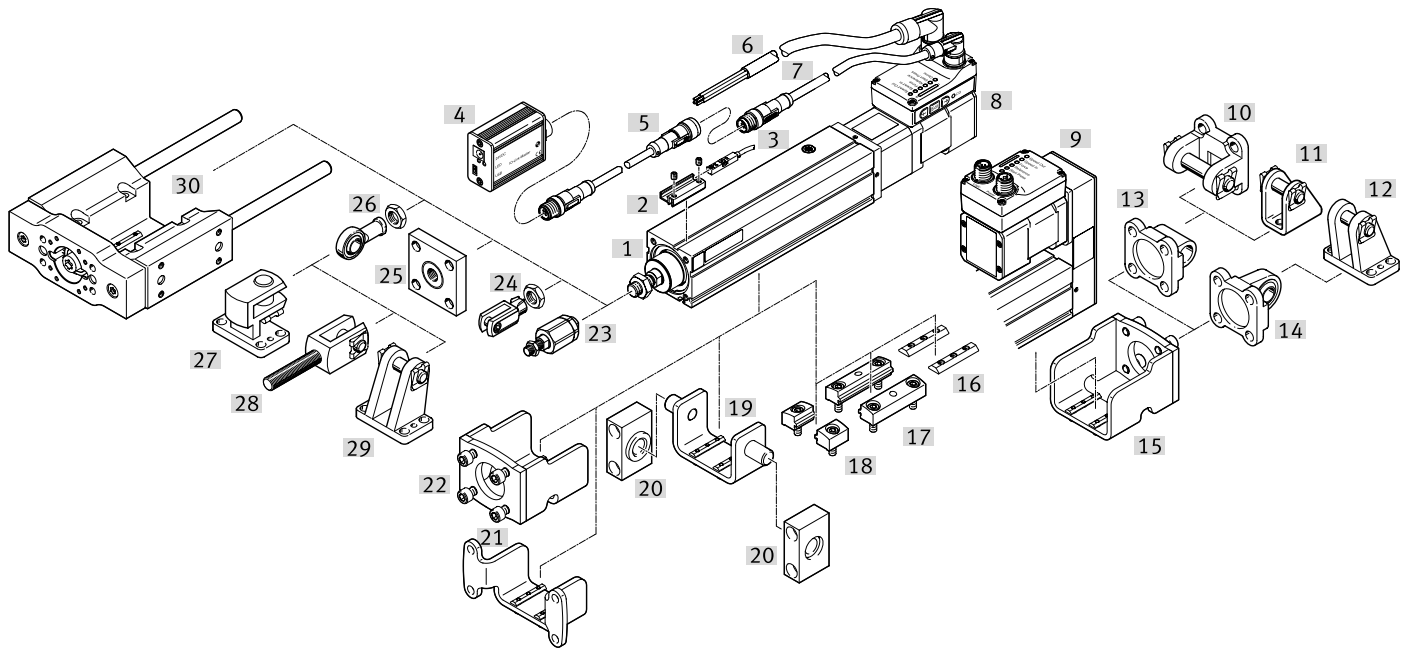

Accessories			→ Page/Internet
Type/order code	Description		
[1] Electric cylinder unit EPCS-BS	Electric drive		epcs
[2] Sensor bracket EAPM-L2	For mounting the proximity switches on the axis. The proximity switches can only be mounted using the sensor bracket.		50
[3] Proximity switches SMT-8M	Magnetic proximity switches, for T-slot		50
[4] IO-Link® master USB CDSU-1	For easy use of the electric cylinder unit with IO-Link®		51
[5] Adapter NEFC-M12G8	<ul style="list-style-type: none"> • Connection between motor and IO-Link® master • Only recommended for use with IO-Link® Port class A master 		51
[6] Supply cable NEBL-T12	For connecting the load and logic supply		51
[7] Connecting cable NEBC-M12	For connection to a controller		52
[8] Axial kit	For axial motor mounting More detailed information → www.festo.com/x/electric-motion-sizing (included in the scope of delivery)		-
[9] Parallel kit	For parallel motor mounting More detailed information → www.festo.com/x/electric-motion-sizing (included in the scope of delivery)		-
[10] Swivel flange SNCB	For parallel motor mounting, for spherical bearing		48
[11] Clevis foot LBN	For parallel motor mounting, for spherical bearing		48
[12] Clevis foot LBG/LBG-...-R3	For parallel motor mounting, for spherical bearing		48
[13] Swivel flange SNCL	With parallel motor mounting		48
[14] Swivel flange SNCS/CRSNCS/SNCS-...-R3	With parallel motor mounting		47
[15] Adapter kit EAHA-P2	<ul style="list-style-type: none"> - For mounting the swivel flange and trunnion flange on the front - Can only be mounted on the rear in conjunction with parallel kit EAMM-U 		47
[16] Slot nut ABAN			50
[17] Profile mounting EAHF-L2-P	<ul style="list-style-type: none"> - For mounting the axis on the side of the profile - The hole in the middle allows the profile mounting to be attached to the mounting surface 		47
[18] Profile mounting EAHF-L2-P-S	For mounting the axis on the side of the profile		47
[19] Trunnion support LN2G	For cylinders with trunnion mounting		47
[20] Swivel mounting EAHS-P2	Position freely selectable along the cylinder length		47
[21] Flange mounting EAHH-P2	<ul style="list-style-type: none"> - For mounting the electric cylinder via the profile - Position within the cylinder length freely selectable 		47
[22] Adapter kit EAHA-P2	<ul style="list-style-type: none"> - For mounting the swivel flange and trunnion flange on the front - Can only be mounted on the rear in conjunction with parallel kit EAMM-U 		47
[23] Self-aligning rod coupler FK/CRFK	To compensate for radial and angular deviations		49
[24] Rod clevis SG/CRSG	Allows a swivelling movement of the cylinder in one plane		49
[25] Coupling piece KSG	To compensate for radial deviations		49
[26] Rod eye SGS/CRSGS	With spherical bearing		49
[27] Right angle clevis foot LQG	For rod eye SGS		48

Peripherals

Accessories		→ Page/Internet
Type/order code	Description	
[28] Rod clevis SGA	For swivelling cylinder mounting	49
[29] Clevis foot LBG/LBG-...-R3	For parallel motor mounting, for spherical bearing	48
[30] Guide unit EAGF	For protecting electric cylinders against rotation at high torque loads	50

Accessories

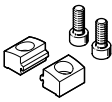
Profile mounting EAHF-L2-...-P-S						
	Description	Material plate	Note on materials	Product weight	Part no.	Type
	For size 32	Anodised wrought aluminium alloy	RoHS-compliant	4 g	5183153	EAHF-L2-25-P-S
	For size 45, 60			6 g	5184133	EAHF-L2-45-P-S

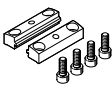
Profile mounting EAHF-L2-...-P						
	Description	Material plate	Note on materials	Product weight	Part no.	Type
	For size 32	Anodised wrought aluminium alloy	RoHS-compliant	19 g	4835684	EAHF-L2-25-P
	For size 45, 60			35 g	4835728	EAHF-L2-45-P

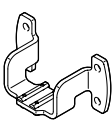
Flange mounting EAHH						
	Description	Note on materials	Product weight	Part no.	Type	
	For size 32	RoHS-compliant	80 g	5126157	EAHH-P2-32	
	For size 45		185 g	5126669	EAHH-P2-45	
	For size 60		320 g	5127005	EAHH-P2-60	

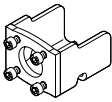
Adapter kit EAHA						
	Description	Note on materials	Product weight	Part no.	Type	
	For size 32	RoHS-compliant	165 g	5173020	EAHA-P2-32	
	For size 45		340 g	5172353	EAHA-P2-45	
	For size 60		560 g	5173082	EAHA-P2-60	

Swivel mounting EAHS						
	Description	Note on materials	Product weight	Part no.	Type	
	For size 32	RoHS-compliant	75 g	5125041	EAHS-P2-32	
	For size 45		165 g	5125167	EAHS-P2-45	
	For size 60		305 g	5125281	EAHS-P2-60	

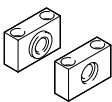
Trunnion support LNZG						
	Description	Material mounting	Note on materials	Product weight	Part no.	Type
	For size 32	Wrought aluminium alloy	RoHS-compliant	26 g	1434912	LNZG-16
	For size 45			83 g	32959	LNZG-32
	For size 60			129 g	32960	LNZG-40/50

Swivel flange SNCS						
	Description	Material mounting	Note on materials	Product weight	Part no.	Type
	For size 45	Die-cast aluminium	RoHS-compliant	86 g	★ 174397	SNCS-32

Accessories

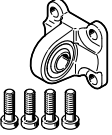
Swivel flange SNCS						
	Description	Material mounting	Note on materials	Product weight	Part no.	Type
	For size 60	Die-cast aluminium	RoHS-compliant	122 g	★ 174398	SNCS-40

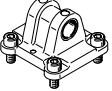
Swivel flange SNCL						
	Description	Material mounting	Note on materials	Product weight	Part no.	Type
	For size 32	Wrought aluminium alloy	RoHS-compliant	38 g	537792	SNCL-20
	For size 45	Die-cast aluminium		71 g	★ 174404	SNCL-32
	For size 60			95 g	★ 174405	SNCL-40

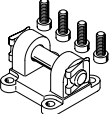
Swivel flange SNCB						
	Description	Material mounting	Note on materials	Product weight	Part no.	Type
	For size 45	Die-cast aluminium	RoHS-compliant	103 g	★ 174390	SNCB-32
	For size 60			155 g	★ 174391	SNCB-40

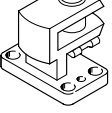
Clevis foot transverse LQG						
	Description	Material mounting	Note on materials	Product weight	Part no.	Type
	For size 45	Stainless steel casting	RoHS-compliant	301 g	31768	LQG-32
	For size 60			369 g	31769	LQG-40

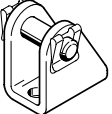
Clevis foot LBN						
	Description	Material mounting	Note on materials	Product weight	Part no.	Type
	For size 32	Steel, Galvanised	RoHS-compliant	84 g	★ 6059	LBN-20/25
	For size 45			110 g	★ 195860	LBN-32
	For size 60			191 g	195861	LBN-40

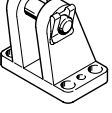
Clevis foot LBG						
	Description	Material mounting	Note on materials	Product weight	Part no.	Type
	For size 45	Stainless steel casting	RoHS-compliant	220 g	31761	LBG-32

Accessories

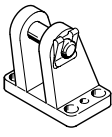
Clevis foot LBG						
	Description	Material mounting	Note on materials	Product weight	Part no.	Type
	For size 60	Stainless steel casting	RoHS-compliant	300 g	31762	LBG-40

Rod eye SGS						
	Description	Material housing	Note on materials	Product weight	Part no.	Type
	For size 32	Galvanised steel	RoHS-compliant	54 g	★ 9255	SGS-M8
	For size 45			88 g	★ 9261	SGS-M10X1,25
	For size 60			130 g	★ 9262	SGS-M12X1,25

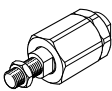
Self-aligning rod coupler FK						
	Description	Material housing	Note on materials	Product weight	Part no.	Type
	For size 32	Steel, Galvanised	RoHS-compliant	50 g	★ 2062	FK-M8
	For size 45			210 g	★ 6140	FK-M10X1,25
	For size 60			215 g	★ 6141	FK-M12X1,25

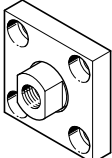
Coupling piece KSG						
	Description	Material mounting	Note on materials	Product weight	Part no.	Type
	For size 45	Steel, Galvanised	RoHS-compliant	229 g	32963	KSG-M10X1,25
	For size 60			447 g	32964	KSG-M12X1,25

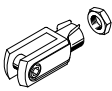
Rod clevis SG						
	Description	Material housing	Note on materials	Product weight	Part no.	Type
	For size 32		RoHS-compliant	53 g	★ 3111	SG-M8
	For size 45			103 g	★ 6144	SG-M10X1,25
	For size 60			166 g	★ 6145	SG-M12X1,25

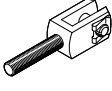
Rod clevis SGA						
	Description	Material housing	Note on materials	Product weight	Part no.	Type
	For size 45		RoHS-compliant	129 g	32954	SGA-M10X1,25
	For size 60			222 g	10767	SGA-M12X1,25

Push-in fitting for sealing air connection						
	Description	Material housing	Size of pack	Product weight	Part no.	Type
	For size 25, 32	Brass, nickel-plated	10	3 g	133004	QSM-M5-4-I-R

Accessories

Push-in fitting for sealing air connection

	Description	Material housing	Size of pack	Product weight	Part no.	Type
	For size 25, 32	Brass, nickel-plated	10	3.2 g	133003	QSM-M5-3-I-R
	For size 45			8.9 g	★ 186266	QSM-G1/8-4-I
				9.5 g	★ 186267	QSM-G1/8-6-I
	For size 60			13 g	★ 186108	QS-G1/4-6-I
				14 g	★ 186110	QS-G1/4-8-I

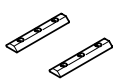
	Material slot nut	Size of pack	Product weight	Part no.	Type
	Steel	2	5 g	8169987	ABAN-3-3M3-30-M-P2
			18 g	8169988	ABAN-5-3M5-40-M-P2

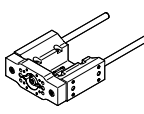
	Description	Stroke	Ambient temperature	Degree of protection	Part no.	Type
	For size 32	1 ... 200 mm	0 ... 60 °C	IP40	8158030	EAGF-P2-KF-32-
		50 mm			8158032	EAGF-P2-KF-32-50
		100 mm			8158029	EAGF-P2-KF-32-100
		150 mm			8158027	EAGF-P2-KF-32-150
		200 mm			8158028	EAGF-P2-KF-32-200
	For size 45	1 ... 300 mm			8158133	EAGF-P2-KF-45-
		50 mm			8158131	EAGF-P2-KF-45-50
		100 mm			8158123	EAGF-P2-KF-45-100
		150 mm			8158125	EAGF-P2-KF-45-150
		200 mm			8158127	EAGF-P2-KF-45-200
	for size 60	300 mm			8158130	EAGF-P2-KF-45-300
		1 ... 500 mm			8158150	EAGF-P2-KF-60-
		100 mm			8158138	EAGF-P2-KF-60-100
		150 mm			8158140	EAGF-P2-KF-60-150
		200 mm			8158142	EAGF-P2-KF-60-200
	300 mm	8158031	EAGF-P2-KF-60-300			

Sensor bracket EAPM-L2

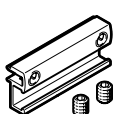
	Material sensor bracket	Note on materials	Product weight	Part no.	Type
	Anodised wrought aluminium alloy	RoHS-compliant	4 g	★ 4759852	EAPM-L2-SH

Proximity switch SMT for T-slot, magneto-resistive

Further information → smt-8m

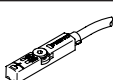
	Type of mounting	Switching output	Electrical connection	Cable length	Part no.	Type
	Screw-clamped, Insertable in the slot from above	3-wire N/C contact NPN	Open end	2.5 m	8138000	SMT-8M-A-NO-24V-E-2,5-OE
				7.5 m	8138001	SMT-8M-A-NO-24V-E-7,5-OE
		3-wire NPN N/O contact	Plug M8, A-coded	2.5 m	★ 574338	SMT-8M-A-NS-24V-E-2,5-OE
				0.3 m	★ 574339	SMT-8M-A-NS-24V-E-0,3-M8D
		3-wire PNP N/C contact	Open end	7.5 m	★ 574340	SMT-8M-A-PO-24V-E-7,5-OE
				2.5 m	★ 574335	SMT-8M-A-PS-24V-E-2,5-OE
3-wire PNP N/O contact	Plug M8, A-coded	0.3 m	★ 574334	SMT-8M-A-PS-24V-E-0,3-M8D		

Accessories

IO-Link® master USB		Further information → cdsu	
	Description	Part no.	Type
	For using the unit with IO-Link®, an external power supply plug is also required (not included in the scope of delivery)	8091509	CDSU-1

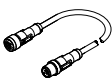
Adapter NEFC						
	Electrical connection 1, connector system	Electrical connection 2, connector system ¹⁾	Electrical connection 2, number of connections/cores	Cable length	Part no.	Type
	M12x1, A-coded to EN 61076-2-101	M12x1, A-coded to EN 61076-2-101	5	0.3 m	8080777	NEFC-M12G8-0.3-M12G5-LK

1) Only recommended for use with IO-Link® Port class A master

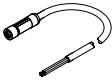
Supply cables NEBL, straight						
	Electrical connection 1, connector system	Electrical connection 2, connector system	Electrical connection 2, number of connections/cores	Cable length	Part no.	Type
	M12x1, T-coded according to EN 61076-2-111	Open end	4	2 m	8080790	NEBL-T12G4-E-2-N-LE4
				5 m	8080791	NEBL-T12G4-E-5-N-LE4
				10 m	8080792	NEBL-T12G4-E-10-N-LE4
				15 m	8080793	NEBL-T12G4-E-15-N-LE4

Supply cables NEBL, angled						
	Electrical connection 1, connector system	Electrical connection 2, connector system	Electrical connection 2, number of connections/cores	Cable length	Part no.	Type
	M12x1, T-coded according to EN 61076-2-111	Open end	4	2 m	8080778	NEBL-T12W4-E-2-N-LE4
				5 m	8080779	NEBL-T12W4-E-5-N-LE4
				10 m	8080780	NEBL-T12W4-E-10-N-LE4
				15 m	8080781	NEBL-T12W4-E-15-N-LE4

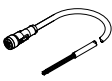
Connecting cables NEBC, straight						
	Electrical connection 1, connector system	Electrical connection 2, connector system	Electrical connection 2, number of connections/cores	Cable length	Part no.	Type
	M12x1, A-coded to EN 61076-2-101	M12x1, A-coded to EN 61076-2-101	8	2 m	8080782	NEBC-M12G8-E-2-N-M12G8
				5 m	8080783	NEBC-M12G8-E-5-N-M12G8
				10 m	8080784	NEBC-M12G8-E-10-N-M12G8
				15 m	8080785	NEBC-M12G8-E-15-N-M12G8
		Open end	2 m	8094480	NEBC-M12G8-E-2-N-B-LE8	
			5 m	8094477	NEBC-M12G8-E-5-N-B-LE8	
			10 m	8094482	NEBC-M12G8-E-10-N-B-LE8	
			15 m	8094475	NEBC-M12G8-E-15-N-B-LE8	

Accessories

Connecting cables NEBC, angled							
	Electrical connection 1, connector system	Electrical connection 2, connector system	Electrical connection 2, number of connections/cores	Cable length	Part no.	Type	
	M12x1, A-coded to EN 61076-2-101	M12x1, A-coded to EN 61076-2-101	8	2 m	8080786	NEBC-M12W8-E-2-N-M12G8	
				5 m	8080787	NEBC-M12W8-E-5-N-M12G8	
				10 m	8080788	NEBC-M12W8-E-10-N-M12G8	
				15 m	8080789	NEBC-M12W8-E-15-N-M12G8	
		Open end		2 m	8094476	NEBC-M12W8-E-2-N-B-LE8	
				5 m	8094478	NEBC-M12W8-E-5-N-B-LE8	
				10 m	8094481	NEBC-M12W8-E-10-N-B-LE8	
				15 m	8094479	NEBC-M12W8-E-15-N-B-LE8	