

Stepper motors EMMT-ST

FESTO

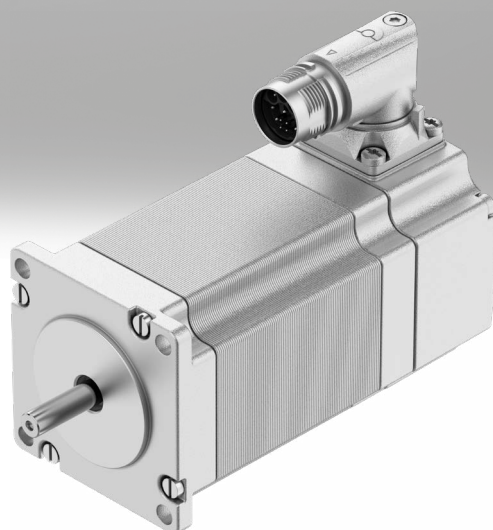

Key features

At a glance

- Two-phase hybrid technology
- 3 flange sizes available: M = 0.25 ... 9.4 Nm
- IP40 protection for motor shaft
- IP65 protection for motor housing with connection technology

Connection technology:

- Simple connection technology (OCP: one cable plug) – hybrid cable: motor cable and connecting cable for supply and encoder in one
- Plug can be rotated 310°

Digital absolute encoder system:

- Single-turn
- Multi-turn, battery-free

Engineering tools

More information → [electric motion sizing](#)



Save time with smart engineering tools for the optimal solution. Our goal is to increase your productivity. Our engineering tools play an integral part in achieving this goal. They help you size your system correctly, tap into unimagined productivity reserves and generate additional productivity along the entire value chain. In every phase of your project, from the initial contact to the modernisation of your machine, you will come across a number of different tools which will be of use to you.

Electric Motion Sizing

- Create the optimum drive package quickly and reliably. Electric Motion Sizing calculates suitable combinations of electric axis, electric motor and servo drive using just a few application details. It provides you with all the relevant data including the bill of materials and documentation for the selected combination. This avoids design errors and results in significantly improved energy efficiency for the system. A smooth connection to the Festo Automation Suite also makes commissioning easier for you.

Graphs

More information → [emmt-st](#)



The graphs shown in this document are also available online. There, precise values can be displayed.

Measuring unit

[S]	Absolute encoder, single-turn	[M]	Absolute encoder, multi-turn
• The angular position is assigned to a unique value in coded form.		• A unique value in coded form is assigned to the angular position and each full turn.	
• The position is only sensed within one turn. All subsequent turns need to be counted by the higher-level device.		• This type counts the full turns until the specified maximum is reached (including when switched off).	
• When switched off, the position is only sensed within one turn.		• Homing is only required once it has been installed in the application.	
• A homing run is required after switch-on.			

Brake

[B]	With brake
-----	------------

The holding brake should not be used as a safety brake.

Type codes

001	Series
EMMT	Servo motor

002	Motor type
ST	Stepper motor ST

003	Flange size, motors [mm]
42	42
57	57
87	87

004	Length
L	Long
M	Medium
S	Short

005	Electrical connection
R	Angled connector, adjustable

006	Measuring unit
	None
M	Absolute encoder, multi-turn
S	Absolute encoder, single turn

007	Brake
	None
B	With brake

Datasheet

General technical data - EMMT-ST-42						
Flange size, motors [mm]	42 mm					
Length	[S]			[L]		
Measuring unit	[]	[M]	[S]	[]	[M]	[S]
Nominal operating voltage DC	48 V					
Nominal motor current	1.8 A			3.4 A		
Continuous stall current	2 A			3.7 A		
Peak current	2 A			4 A		
Rated motor output ¹⁾	-		17 W	-		56 W
Step angle with full step	1.8 deg					
Stepping angle tolerance	±5%					
Motor holding torque	0.25 Nm			0.63 Nm		
Nominal torque ¹⁾	-		0.24 Nm	-		0.54 Nm
Peak torque	0.25 Nm			0.63 Nm		
Nominal rotational speed ¹⁾	-		600 rpm	-		1,000 rpm
Maximum speed	2,700 rpm			3,200 rpm		
Max. mechanical rotational speed	9,000 rpm					
Motor constant	0.159 Nm/A			0.162 Nm/A		
Voltage constant, phase	12.1 mV/min			10.6 mV/min		
Electric time constant	1.4 ms			1.3 ms		
Thermal time constant	22 mins			16 mins		
Thermal resistance	3.5 K/W			2 K/W		
I ² T time motor	2 s					
Number of phases	2					
Number of pole pairs	50					
Winding resistance phase	2.1 Ohm			0.6 Ohm		
Winding inductance phase per individual phase (un-linked)	3 mH			0.8 mH		
Winding series inductance Ld (phase)	1.6 mH			1.45 mH		
Winding shunt inductance Lq (phase)	3 mH			0.8 mH		
Permissible axial shaft load	10 N					
Permissible radial shaft load	28 N					
Measuring flange	200 x 200 x 15 mm, steel					

1) No nominal operating point is defined for motors without encoders.

Datasheet

General technical data - EMMT-ST-57						
Flange size, motors [mm]	57 mm					
Length	[M]			[L]		
Measuring unit	[]	[M]	[S]	[]	[M]	[S]
Nominal operating voltage DC	48 V					
Nominal motor current	5.4 A			5.2 A		
Continuous stall current	6.6 A			6.1 A		
Peak current	8 A					
Rated motor output ¹⁾	–	87 W		–	86 W	
Step angle with full step	1.8 deg					
Stepping angle tolerance	±5%					
Motor holding torque	1.12 Nm			1.86 Nm		
Nominal torque ¹⁾	–	0.83 Nm		–	1.64 Nm	
Peak torque	1.1 Nm			2.1 Nm		
Nominal rotational speed ¹⁾	–	1,000 rpm		–	500 rpm	
Maximum speed	2,600 rpm			1,500 rpm		
Max. mechanical rotational speed	8,000 rpm					
Motor constant	0.152 Nm/A			0.32 Nm/A		
Voltage constant, phase	13.1 mV/min			22.6 mV/min		
Electric time constant	2.9 ms			3.7 ms		
Thermal time constant	27 mins			30 mins		
Thermal resistance	1.6 K/W			1.3 K/W		
I ² T time motor	2 s					
Number of phases	2					
Number of pole pairs	50					
Winding resistance phase	0.17 Ohm			0.26 Ohm		
Winding inductance phase per individual phase (un-linked)	0.5 mH			0.95 mH		
Winding series inductance L _d (phase)	0.7 mH			1.75 mH		
Winding shunt inductance L _q (phase)	0.5 mH			0.95 mH		
Permissible axial shaft load	15 N					
Permissible radial shaft load	75 N					
Measuring flange	200 x 200 x 15 mm, steel					

1) No nominal operating point is defined for motors without encoders.

Datasheet

General technical data - EMMT-ST-87

Flange size, motors [mm]	87 mm								
Length	[S]			[M]			[L]		
Measuring unit	[]	[M]	[S]	[]	[M]	[S]	[]	[M]	[S]
Nominal operating voltage DC	48 V								
Nominal motor current	7.8 A			7.5 A			8.4 A		
Continuous stall current	9.5 A			8.2 A			10 A		
Peak current	12 A						10 A		
Rated motor output ¹⁾	–			159 W			–		
				87 W			–		
Step angle with full step	1.8 deg								
Stepping angle tolerance	±5%								
Motor holding torque	2.4 Nm			6.6 Nm			9.4 Nm		
Nominal torque ¹⁾	–			1.9 Nm			–		
				5.9 Nm			–		
Peak torque	2.7 Nm			6.8 Nm			9.4 Nm		
Nominal rotational speed ¹⁾	–			800 rpm			–		
				140 rpm			–		
Maximum speed	2,200 rpm			600 rpm			430 rpm		
Max. mechanical rotational speed	7,000 rpm								
Motor constant	0.24 Nm/A			0.79 Nm/A			1.06 Nm/A		
Voltage constant, phase	15.4 mV/min			56.6 mV/min			78.9 mV/min		
Electric time constant	1.75 ms			8.5 ms			9 ms		
Thermal time constant	35 mins			32 mins			37 mins		
Thermal resistance	0.89 K/W			0.83 K/W			0.75 K/W		
I ² T time motor	2 s								
Number of phases	2								
Number of pole pairs	50								
Winding resistance phase	0.13 Ohm			0.27 Ohm			0.3 Ohm		
Winding inductance phase per individual phase (un-linked)	0.35 mH			2.3 mH			2.7 mH		
Winding series inductance Ld (phase)	0.56 mH			3.6 mH			4.1 mH		
Winding shunt inductance Lq (phase)	0.35 mH			2.3 mH			2.7 mH		
Permissible axial shaft load	60 N								
Permissible radial shaft load	220 N								
Measuring flange	250 x 250 x 15 mm, steel								

1) No nominal operating point is defined for motors without encoders.

Datasheet

Technical data - Brakes

Flange size, motors [mm]	42	57	87
Brake holding torque	0.63 Nm	1.74 Nm	4.26 Nm
Operating voltage DC brake	24 V		
Brake current consumption	0.34 A	0.38 A	0.49 A
Brake power consumption	8.2 W	9 W	12 W
Brake coil resistance	70.9 Ohm	63.8 Ohm	49.2 Ohm
Brake coil inductivity	146 mH	107 mH	110 mH
Brake separation time	28 ms	32 ms	44 ms
Brake closing time	41 ms	97 ms	110 ms
DC brake response delay	8 ms	11 ms	30 ms
Max. brake no-load speed	9,000 rpm	8,000 rpm	7,000 rpm
Brake max. friction	1,500 J	6,000 J	14,000 J
Mass moment of inertia, brake	0.006 kgcm ²	0.024 kgcm ²	0.11 kgcm ²
Switching cycles, holding brake	10 million idle actuations (without friction!)		

Technical data – Encoder

Flange size, motors [mm]	42		57		87	
Measuring unit	[S]	[M]	[S]	[M]	[S]	[M]
Rotor position sensor measuring principle	Magnetic					
Rotary position encoder interface	BiSS-C					
Rotor position encoder, absolute detectable revolutions	–	16,384	–	16,384	–	16,384
Rotor position encoder, DC operating voltage	5 V		14 V		5 V	
Rotor position encoder, DC operating voltage range	4.75 ... 5.25 V	4.5 ... 5.5 V	4.75 ... 5.25 V	4.75 ... 15 V	4.75 ... 5.25 V	4.75 ... 15 V
Rotor position encoder, sinusoidal/cosinusoidal periods per revolution	2					
Rotor position encoder, position values per revolution	65,536	131,072	65,536	131,072	65,536	131,072
Rotor position encoder resolution	16 bit	17 bit	16 bit	17 bit	16 bit	17 bit
Rotor position encoder, system accuracy of angle measurement	-65 ... 65 arcsec	-310 ... 310 arcsec	-65 ... 65 arcsec	-360 ... 360 arcsec	-65 ... 65 arcsec	-360 ... 360 arcsec
Rotor position encoder, max. operating speed	5,500 rpm	12,000 rpm	5,500 rpm	12,000 rpm	5,500 rpm	12,000 rpm
Rotor position encoder, temperature range	-40 ... 105 °C					
MTTF, subcomponent ¹⁾	687 years, rotor position encoder	20 years, rotor position encoder	687 years, rotor position encoder	20 years, rotor position encoder	687 years, rotor position encoder	20 years, rotor position encoder

1) The data given applies to an encoder temperature/operating temperature of 40°C.

Datasheet

Total output moment of inertia - EMMT-ST-42

Flange size, motors [mm]	42											
Length	[S]						[L]					
Measuring unit	[]		[M]		[S]		[]		[M]		[S]	
Brake	[]		[B]		[]		[]		[B]		[]	
Total output moment of inertia	0.035 kgcm ²		0.043 kgcm ²		0.041 kgcm ²		0.082 kgcm ²		0.09 kgcm ²		0.088 kgcm ²	

Total output moment of inertia - EMMT-ST-57

Flange size, motors [mm]	57											
Length	[M]						[L]					
Measuring unit	[]		[M]		[S]		[]		[M]		[S]	
Brake	[]		[B]		[]		[]		[B]		[]	
Total output moment of inertia	0.3 kgcm ²		0.33 kgcm ²		0.324 kgcm ²		0.48 kgcm ²		0.51 kgcm ²		0.504 kgcm ²	

Total output moment of inertia - EMMT-ST-87

Flange size, motors [mm]	87																	
Length	[S]				[M]				[L]									
Measuring unit	[]		[M]		[S]		[]		[M]		[S]							
Brake	[]		[B]		[]		[B]		[]		[B]							
Total output moment of inertia	1 kgcm ²		1.116 kgcm ²		1.11 kgcm ²		1.9 kgcm ²		2.016 kgcm ²		2.01 kgcm ²		3 kgcm ²		3.116 kgcm ²		3.11 kgcm ²	

Weight

Flange size, motors [mm]	42				57				87					
Length	[S]		[L]		[M]		[L]		[S]		[M]		[L]	
Brake	[]	[B]	[]	[B]	[]	[B]	[]	[B]	[]	[B]	[]	[B]	[]	[B]
Product weight	370 g	590 g	560 g	770 g	900 g	1,300 g	1,260 g	1,660 g	2,050 g	2,890 g	3,490 g	4,320 g	4,660 g	5,490 g

Datasheet

Operating and environmental conditions							
Flange size, motors [mm]	42		57		87		
Length	[S]	[L]	[M]	[L]	[S]	[M]	[L]
Conforms to standard	IEC 60034						
Motor type to EN 60034-7	IM B5, IM V1, IM V3						
Degree of protection	IP40						
Note on degree of protection	IP40 for motor shaft without radial shaft seal, IP65 for motor housing including connection technology						
Ambient temperature	0 ... 40°C		-15 ... 40°C				
Note on ambient temperature	Up to 80 °C with derating -2%/°C						
Storage temperature	-20 ... 70 °C						
Max. winding temperature	130°C						
Temperature monitoring	Digital Motor temp. via BiSS-C						
Rating class according to EN 60034-1	S1						
Thermal class according to EN 60034-1	B						
Relative humidity	0 - 90%						
CE marking (see declaration of conformity) ¹⁾	To EU EMC Directive To EU RoHS Directive						
UKCA marking (see declaration of conformity) ²⁾	To UK EMC regulations To UK RoHS regulations						
Certification	RCM c UL us - Recognized (OL)						
Certificate-issuing authority	UL E342973						
Vibration resistant	Transport application test with severity level 2 to FN 942017-4 and EN 60068-2-6						
Shock resistance	Shock test with severity level 2 to FN 942017-5 and EN 60068-2-27						
Isolation resistance AC	0.6						
Electrical connection 1, Connection type	Hybrid plug						
LABS (PWIS) conformity	VDMA24364 zone III						
Note on materials	RoHS-compliant						

1) More information www.festo.com/catalogue/emms-st → Support/Downloads.

2) More information www.festo.com/catalogue/emms-st → Support/Downloads.

Datasheet

Torque M as a function of rotational speed n

EMMT-ST-42-S

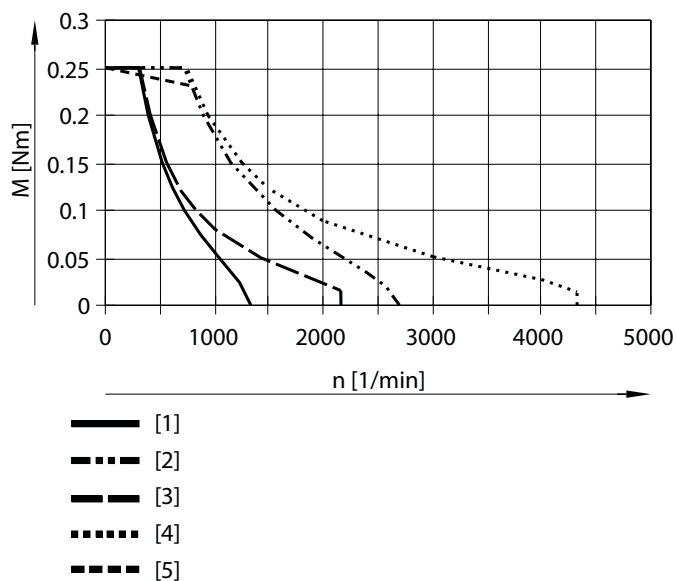

- [1] Peak torque at 24 V DC
- [2] Peak torque at 48 V DC
- [3] Field weakened peak torque at 24V DC
- [4] Field weakened peak torque at 48V DC
- [5] Nominal torque

Typical motor characteristic curve with nominal voltage and optimal motor controller.

Observe the maximum permissible rotational speed of add-on and installation components (such as encoder, brake etc.)!

EMMT-ST-42-L

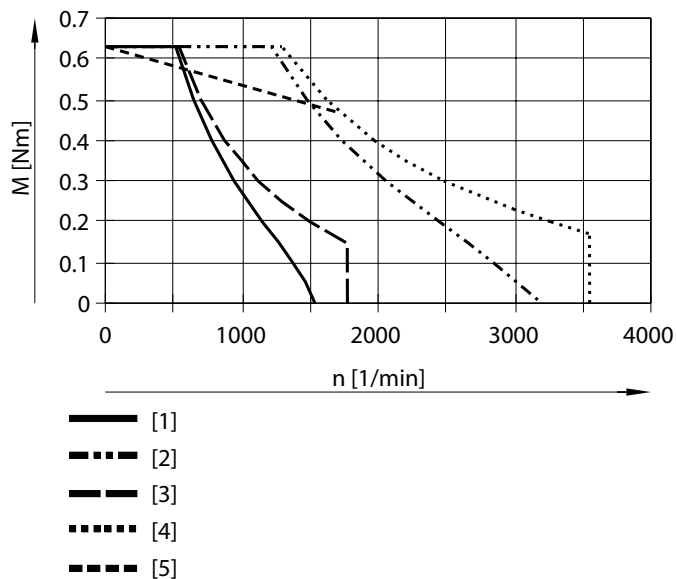

- [1] Peak torque at 24 V DC
- [2] Peak torque at 48 V DC
- [3] Field weakened peak torque at 24V DC
- [4] Field weakened peak torque at 48V DC
- [5] Nominal torque

Typical motor characteristic curve with nominal voltage and optimal motor controller.

Observe the maximum permissible rotational speed of add-on and installation components (such as encoder, brake etc.)!

Datasheet

Torque M as a function of rotational speed n

EMMT-ST-57-M

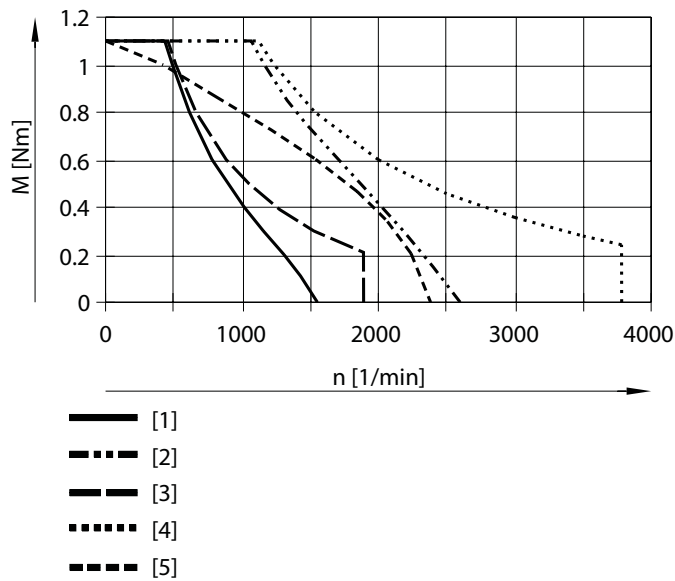

- [1] Peak torque at 24 V DC
- [2] Peak torque at 48 V DC
- [3] Field weakened peak torque at 24V DC
- [4] Field weakened peak torque at 48V DC
- [5] Nominal torque

Typical motor characteristic curve with nominal voltage and optimal motor controller.

Observe the maximum permissible rotational speed of add-on and installation components (such as encoder, brake etc.)!

EMMT-ST-57-L

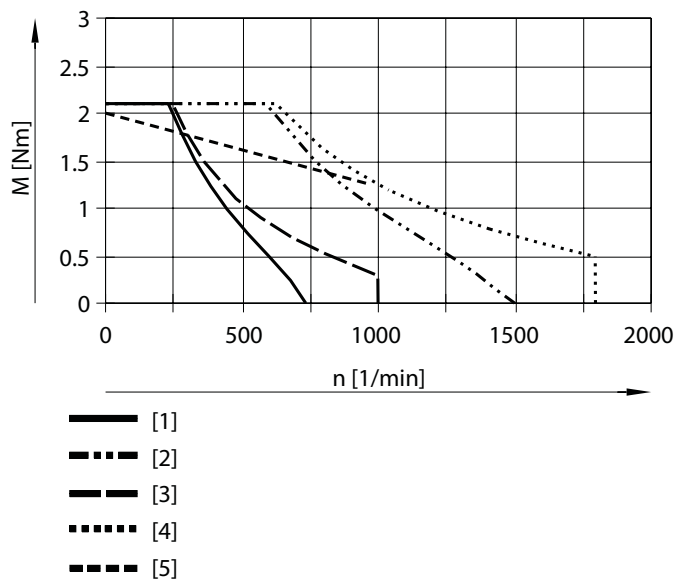

- [1] Peak torque at 24 V DC
- [2] Peak torque at 48 V DC
- [3] Field weakened peak torque at 24V DC
- [4] Field weakened peak torque at 48V DC
- [5] Nominal torque

Typical motor characteristic curve with nominal voltage and optimal motor controller.

Observe the maximum permissible rotational speed of add-on and installation components (such as encoder, brake etc.)!

Datasheet

Torque M as a function of rotational speed n

EMMT-ST-87-S

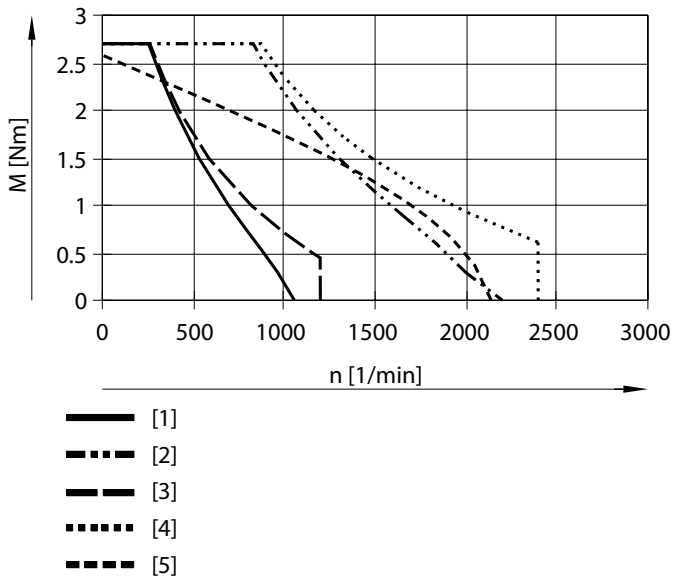

- [1] Peak torque at 24 V DC
- [2] Peak torque at 48 V DC
- [3] Field weakened peak torque at 24V DC
- [4] Field weakened peak torque at 48V DC
- [5] Nominal torque

Typical motor characteristic curve with nominal voltage and optimal motor controller.
Observe the maximum permissible rotational speed of add-on and installation components (such as encoder, brake etc.)!

EMMT-ST-87-M

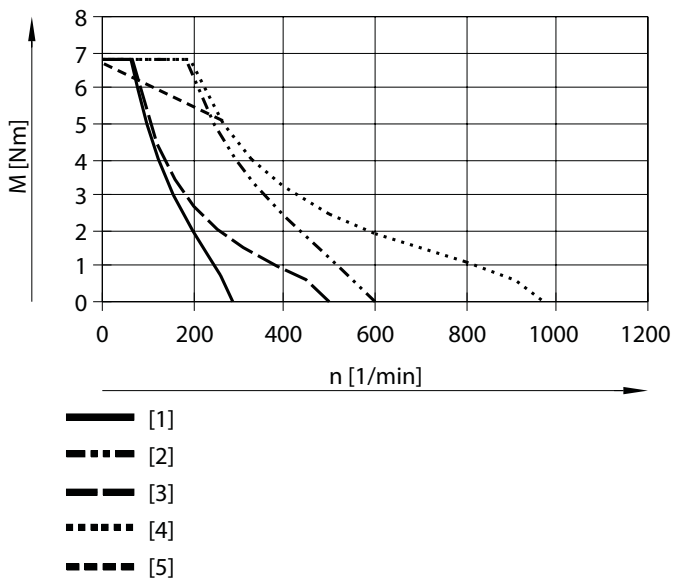

- [1] Peak torque at 24 V DC
- [2] Peak torque at 48 V DC
- [3] Field weakened peak torque at 24V DC
- [4] Field weakened peak torque at 48V DC
- [5] Nominal torque

Typical motor characteristic curve with nominal voltage and optimal motor controller.
Observe the maximum permissible rotational speed of add-on and installation components (such as encoder, brake etc.)!

Datasheet

Torque M as a function of rotational speed n

EMMT-ST-87-L

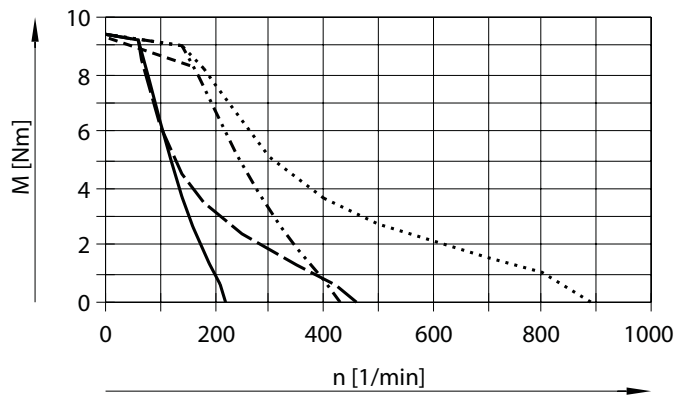

- [1]
- · - · [2]
- - - [3]
- · · · [4]
- - - [5]

- [1] Peak torque at 24 V DC
- [2] Peak torque at 48 V DC
- [3] Field weakened peak torque at 24V DC
- [4] Field weakened peak torque at 48V DC
- [5] Nominal torque

Typical motor characteristic curve with nominal voltage and optimal motor controller.

Observe the maximum permissible rotational speed of add-on and installation components (such as encoder, brake etc.)!

Datasheet

Dimensions – EMMT-ST-42/-57/-87

Download CAD data → www.festo.com

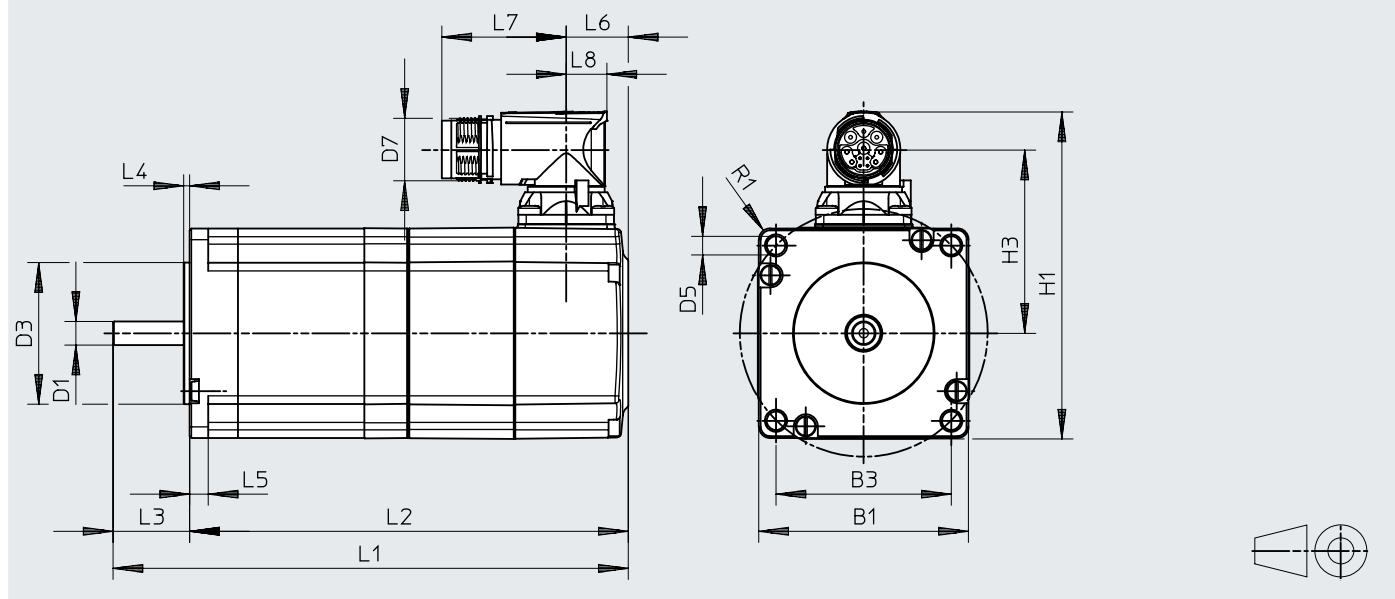

		B1	B3	D1	D3	D5	D7	H1	H3
			±0.2	∅ h6	∅ h8				
EMMT-ST-42	S	42	31	5	22	M3	M17	73.3	41.9
	S-B								
	L								
	L-B								
EMMT-ST-57	M	56.4	47.1	6.4	38.1	5	M17	88	49.3
	M-B								
	L								
	L-B								
EMMT-ST-87	S	85.9	69.5	11	73	6.6	M17	118	64.4
	S-B								
	M								
	M-B								
	L								
	L-B								

		L1	L2	L3	L4	L5	L6	L7	L8	R1
			±2	±0.5	±0.2					
EMMT-ST-42	S	94	70	24	2	-	16	33.4	11	2.3
	S-B	124	100							
	L	112	88							
	L-B	142	118							
EMMT-ST-57	M	110.1	89.5	20.6	1.6	5	16.7	33.4	11	3
	M-B	138.6	118							
	L	131.1	110.5							
	L-B	159.6	139							
EMMT-ST-87	S	121	94	27	2	8	16	33.4	11	5.5
	S-B	149.5	122.5							
	M	154.5	127.5							
	M-B	183	156							
	L	184.5	158.5							
	L-B	213	186							

Ordering data

Ordering data Length	Measuring unit	Brake	Part no.	Type
EMMT-ST-42				
Short [S]	None	None	8156161	EMMT-ST-42-S-R
	Absolute encoder, single turn [S]		8156162	EMMT-ST-42-S-RS
	Absolute encoder, multi-turn [M]		8156163	EMMT-ST-42-S-RM
	None	With brake [B]	8156164	EMMT-ST-42-S-RB
	Absolute encoder, single turn [S]		8156165	EMMT-ST-42-S-RSB
	Absolute encoder, multi-turn [M]		8156166	EMMT-ST-42-S-RMB
Long [L]	None	None	8156167	EMMT-ST-42-L-R
	Absolute encoder, single turn [S]		8156168	EMMT-ST-42-L-RS
	Absolute encoder, multi-turn [M]		8156169	EMMT-ST-42-L-RM
	None	With brake [B]	8156170	EMMT-ST-42-L-RB
	Absolute encoder, single turn [S]		8156171	EMMT-ST-42-L-RSB
	Absolute encoder, multi-turn [M]		8156172	EMMT-ST-42-L-RMB
EMMT-ST-57				
Medium [M]	None	None	8156173	EMMT-ST-57-M-R
	Absolute encoder, single turn [S]		8156174	EMMT-ST-57-M-RS
	Absolute encoder, multi-turn [M]		8156175	EMMT-ST-57-M-RM
	None	With brake [B]	8156176	EMMT-ST-57-M-RB
	Absolute encoder, single turn [S]		8156177	EMMT-ST-57-M-RSB
	Absolute encoder, multi-turn [M]		8156178	EMMT-ST-57-M-RMB
Long [L]	None	None	8156179	EMMT-ST-57-L-R
	Absolute encoder, single turn [S]		8156180	EMMT-ST-57-L-RS
	Absolute encoder, multi-turn [M]		8156181	EMMT-ST-57-L-RM
	None	With brake [B]	8156182	EMMT-ST-57-L-RB
	Absolute encoder, single turn [S]		8156183	EMMT-ST-57-L-RSB
	Absolute encoder, multi-turn [M]		8156184	EMMT-ST-57-L-RMB
EMMT-ST-87				
Short [S]	None	None	8156185	EMMT-ST-87-S-R
	Absolute encoder, single turn [S]		8156186	EMMT-ST-87-S-RS
	Absolute encoder, multi-turn [M]		8156187	EMMT-ST-87-S-RM
	None	With brake [B]	8156188	EMMT-ST-87-S-RB
	Absolute encoder, single turn [S]		8156189	EMMT-ST-87-S-RSB
	Absolute encoder, multi-turn [M]		8156190	EMMT-ST-87-S-RMB
Medium [M]	None	None	8156191	EMMT-ST-87-M-R
	Absolute encoder, single turn [S]		8156192	EMMT-ST-87-M-RS
	Absolute encoder, multi-turn [M]		8156193	EMMT-ST-87-M-RM
	None	With brake [B]	8156194	EMMT-ST-87-M-RB
	Absolute encoder, single turn [S]		8156195	EMMT-ST-87-M-RSB
	Absolute encoder, multi-turn [M]		8156196	EMMT-ST-87-M-RMB
Long [L]	None	None	8156197	EMMT-ST-87-L-R
	Absolute encoder, single turn [S]		8156198	EMMT-ST-87-L-RS
	Absolute encoder, multi-turn [M]		8156199	EMMT-ST-87-L-RM
	None	With brake [B]	8156200	EMMT-ST-87-L-RB
	Absolute encoder, single turn [S]		8156201	EMMT-ST-87-L-RSB
	Absolute encoder, multi-turn [M]		8156202	EMMT-ST-87-L-RMB

Accessories

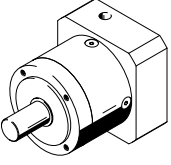
Planetary gear for EMMT-ST-42		Datasheets → Internet: emga		
	Gear ratio	Product weight	Part no.	Type
	3:1	350 g	☆ 549428	EMGA-40-P-G3-SST-42
	5:1	350 g	☆ 549429	EMGA-40-P-G5-SST-42
	8:1	400 g	8141762	EMGA-40-P-G8-SST-42
	12:1	450 g	8141763	EMGA-40-P-G12-SST-42

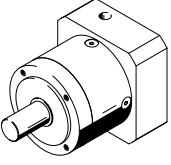

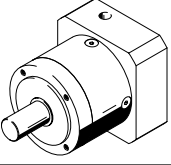
Planetary gear for EMMT-ST-57		Datasheets → Internet: emga		
	Gear ratio	Product weight	Part no.	Type
	3:1	900 g	☆ 549430	EMGA-60-P-G3-SST-57
	5:1	900 g	☆ 549431	EMGA-60-P-G5-SST-57
	8:1	900 g	8141764	EMGA-60-P-G8-SST-57
	12:1	1100 g	8141765	EMGA-60-P-G12-SST-57

Planetary gear for EMMT-ST-87		Datasheets → Internet: emga		
	Gear ratio	Product weight	Part no.	Type
	3:1	2100 g	☆ 549432	EMGA-80-P-G3-SST-87
	5:1	2100 g	☆ 549433	EMGA-80-P-G5-SST-87
	8:1	2100 g	8141766	EMGA-80-P-G8-SST-87
	12:1	2600 g	8141767	EMGA-80-P-G12-SST-87

Accessories

Recommended cable cross section as a function of cable length and servo drive CMMT-ST

	Up to 5 m	Up to 10 m	Up to 20 m	Up to 25 m
EMMT-ST-42-S-...	Q6	Q6	Q6	Q6
EMMT-ST-42-L-...	Q6	Q6	Q7	Q7
EMMT-ST-57-M-...	Q6	Q7	Q9	Q9
EMMT-ST-57-L-...	Q6	Q7	Q9	Q9
EMMT-ST-87-S-...	Q7	Q9	Q9	Q9
EMMT-ST-87-M-...	Q7	Q9	Q9	Q9
EMMT-ST-87-L-...	Q7	Q9	Q9	Q9

	Q6 = 0.5mm ²
	Q7 = 0.75mm ²
	Q9 = 1.5mm ²

Ordering data – Motor cable

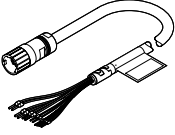
	Cable cross section ¹⁾	Bending radius, flexible cable installation	Cable characteristic	Cable length	Part no.	Type
	0.5 mm ²	78.75 mm	Suitable for energy chains	2.5 m	8181670	NEBM-M17G12-EH-2.5-Q6N-LE12
				5 m	8181668	NEBM-M17G12-EH-5-Q6N-LE12
				7.5 m	8190096	NEBM-M17G12-EH-7.5-Q6N-LE12
				10 m	8195457	NEBM-M17G12-EH-10-Q6N-LE12
	0.75 mm ²	78.75 mm	Suitable for energy chains	2.5 m	8195458	NEBM-M17G12-EH-2.5-Q7N-LE12
				5 m	8195459	NEBM-M17G12-EH-5-Q7N-LE12
				7.5 m	8195460	NEBM-M17G12-EH-7.5-Q7N-LE12
	0.5 ... 1.5 mm ²	78.75 ... mm	Suitable for energy chains	0.5 ... 25 m	8181663	NEBM-LX/M17-

1) For NEBM-LX/M17-...: choice of cable lengths: 0.5 ... 25 m, in 0.5 m grid and all cable cross-sections Q6, Q7, Q9

Ordering data – Mounting flange for fitting the motor cable plug (e.g. on the control cabinet)

	Note on materials	Part no.	Type
	RoHS-compliant	8191777	NEAM-MF-M17