

## Servo motors EMME-AS

**FESTO**



Festo core product range  
Covers 80% of your automation tasks

Worldwide:

Always in stock

Superb:

Festo quality at an attractive price

Easy:

Simplified procurement and warehousing

★ Generally ready for dispatch from the factory within 24 hours

In stock at 13 Service Centres worldwide

More than 2200 products

★ Generally ready for dispatch from the factory within 5 days

Assembled for you at 4 Service Centres worldwide

Up to  $6 \times 10^{12}$  variants per product family

Just look  
for the  
star!

## Key features

### Everything from a single source

Motors EMME-AS

→ Page 3



- Brushless, permanently excited synchronous servo motors
- Reliable, dynamic, precise
- Digital absolute displacement encoder; choose from:
  - Single-turn
  - Multi-turn
  - Multi-turn with SIL2
- Optimised connection technology
- Winding variants
  - For single-phase motor controller
  - For three-phase motor controller
  - Speed-optimised
- Degree of protection: IP21 (motor shaft)
- Degree of protection: IP65 (motor housing incl. connection technology)
- Optional:
  - Holding brake

### Gear unit EMGA-EAS/-SAS

→ Page 18



- Planetary/right-angle gear unit
- Gear ratio  $i = 3, 5, 8, 12, 20$
- Life-time lubrication
- Degree of protection: IP54

### Motor controller CMMP-AS

→ Internet: cmm



- Digital servo motor controller (0.5 kVA ... 18 kVA)
- Control of AC servo and linear motors
- Integrated EMC filters
- Integrated brake chopper
- Integrated safety functions
- Position controller with closed-loop position control (256 position sets)
- Speed controller
- Torque control via current regulator
- Range of control functions
- Interfaces:
  - I/O interface
  - CANopen, standard
  - PROFIBUS DP, optional module
  - DeviceNet, optional module
  - PROFINET RT, optional module
  - EtherCAT, optional module
  - EtherNet/IP, optional module

### Motor and encoder cables NEBM

→ Page 19



- Suitable for energy chains
- Connection technology on motor side with degree of protection to IP65
- Can be used in a wide temperature range

### Spanner EADTS-M2 for attaching the cables NEBM to the motor

→ Page 20

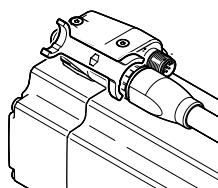
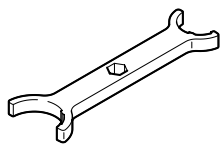

The spanner is included in the scope of delivery of the motor cable.

### EMC filter CAMF-C5-FC

→ Page 21

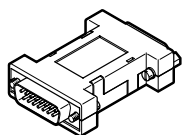

For cable lengths  $\geq 10$  m, the use of the EMC filter is recommended to reduce EMC interference.

The EMC filter is only required in combination with the motor controller CMMP-AS.

### Axial and parallel kits EAMM

→ Internet: eamm



- Specific kits for all electromechanical axes from Festo
- Each kit includes the relevant necessary coupling housing, couplings and motor flange as well as all screws
- Optionally with degree of protection IP65

PROFIBUS®, PROFINET®, DeviceNet®, CANopen®, EtherCAT® and EtherNet/IP® are registered trademarks of their respective trademark holders in certain countries.

## Type code

001	Series
EMME	Motor
002	Motor type
AS	AC synchronous
003	Flange size, motors
40	40
60	60
80	80
100	100
004	Length
S	Short
M	Centre
005	Output shaft
	Smooth shaft
K	Shaft to DIN 6885

006	Winding
LS	Low voltage, standard
LV	Low voltage, speed optimised
HS	High voltage, standard
007	Electrical connection
A	Angled plug
008	Measuring unit
S	Absolute encoder, single turn
M	Absolute encoder, multi-turn
MX	Absolute safety encoder, multi-turn, Hiperface
009	Brake
	None
B	With brake

Data sheet



**Note**  
Motors and motor controllers from Festo have been specially designed to be used together. Trouble-free operation cannot be guaranteed in combination with third-party controllers.

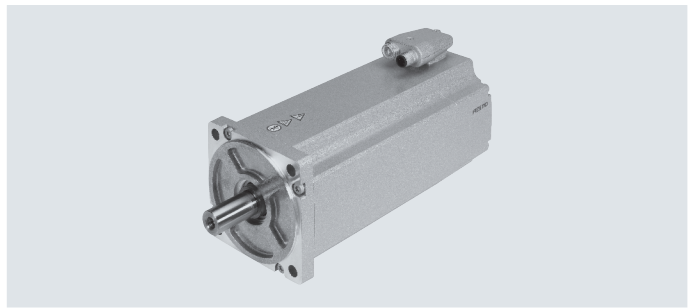

Technical data			
Flange size		40	
Length		S	M
Winding		LV	LV
Motor			
Nominal voltage	[V DC]	360	360
Nominal current	[A]	0.7	1.2
Continuous stall current	[A]	0.8	1.6
Peak current	[A]	3.2	6.4
Nominal power	[W]	110	200
Nominal torque	[Nm]	0.12	0.21
Peak torque	[Nm]	0.7	1.4
Stall torque	[Nm]	0.18	0.35
Nominal rotational speed	[rpm]	9000	9000
Max. rotational speed	[rpm]	10000	10000
Motor constant	[Nm/A]	0.171	0.175
Voltage constant (phase-to-phase)	[mV/min]	13.5	13.2
Number of pole pairs		2	2
Winding resistance	[Ω]	25.6	8.6
Winding inductance	[mH]	14.8	6.6
Total output moment of inertia			
Without brake	[kgcm <sup>2</sup> ]	0.03	0.054
With brake	[kgcm <sup>2</sup> ]	0.055	0.079
Shaft load at nominal rotational speed			
Radial	[N]	105	115
Axial	[N]	21	23
Brake			
Operating voltage	[V DC]	24 +6 ... -10%	
Power	[W]	8	
Holding torque	[Nm]	0.4	
Mass moment of inertia	[kgcm <sup>2</sup> ]	0.014	

## Data sheet

<b>Technical data</b>			
Flange size		60	
Length		S	M
Winding		LS	LS
<b>Motor</b>			
Nominal voltage	[V DC]	360	360
Nominal current	[A]	0.8	1.5
Continuous stall current	[A]	0.9	1.8
Peak current	[A]	3.6	7.2
Nominal power	[W]	190	380
Nominal torque	[Nm]	0.6	1.2
Peak torque	[Nm]	2.8	6.0
Stall torque	[Nm]	0.7	1.5
Nominal rotational speed	[rpm]	3000	3000
Max. rotational speed	[rpm]	5131	4925
Motor constant	[Nm/A]	0.750	0.800
Voltage constant (phase-to-phase)	[mV/min]	49.6	51.7
Winding resistance	[Ω]	26.4	9.8
Number of pole pairs		3	3
Winding inductance	[mH]	37.6	18.6
Total output moment of inertia			
Without brake	[kgcm <sup>2</sup> ]	0.22	0.413
With brake	[kgcm <sup>2</sup> ]	0.319	0.512
Shaft load at nominal rotational speed			
Radial	[N]	250	270
Axial	[N]	50	54
<b>Brake</b>			
Operating voltage	[V DC]	24 +6 ... -10%	
Power	[W]	11	
Holding torque	[Nm]	2	
Mass moment of inertia	[kgcm <sup>2</sup> ]	0.086	

## Data sheet

Technical data					
Flange size		80			
Length		S		M	
Winding		LS	HS	LS	HS
Motor					
Nominal voltage	[V DC]	360	565	360	565
Nominal current	[A]	2.6	1.6	3.7	2.1
Continuous stall current	[A]	3.1	1.8	3.9	2.2
Peak current	[A]	12.4	7.2	15.6	8.8
Nominal power	[W]	750	720	1000	1000
Nominal torque	[Nm]	2.4	2.3	3.2	3.2
Peak torque	[Nm]	11.2	11.2	14.0	14.0
Stall torque	[Nm]	2.8	2.8	3.5	3.5
Nominal rotational speed	[rpm]	3000	3000	3000	3000
Max. rotational speed	[rpm]	4690	4192	4627	4097
Motor constant	[Nm/A]	0.923	1.438	0.865	1.524
Voltage constant (phase-to-phase)	[mV/min]	54.3	95.3	55	97.5
Number of pole pairs		3	3	3	3
Winding resistance	[Ω]	4.6	14.2	2.8	9.0
Winding inductance	[mH]	11.8	36.2	8.4	26.0
Total output moment of inertia					
Without brake	[kgcm <sup>2</sup> ]	1.40		1.93	
With brake	[kgcm <sup>2</sup> ]	1.68		2.20	
Shaft load at nominal rotational speed					
Radial	[N]	350		360	
Axial	[N]	70		72	
Brake					
Operating voltage	[V DC]	24 +6 ... -10%		24 +6 ... -10%	
Power	[W]	12		12	
Holding torque	[Nm]	4.5		4.5	
Mass moment of inertia	[kgcm <sup>2</sup> ]	0.222		0.222	

## Data sheet

Technical data			
Flange size		100	
Length		S	M
Winding		HS	HS
Motor			
Nominal voltage	[V DC]	565	565
Nominal current	[A]	3.0	4.1
Continuous stall current	[A]	3.4	4.6
Peak current	[A]	13.6	18.4
Nominal power	[W]	1500	2000
Nominal torque	[Nm]	4.8	6.4
Peak torque	[Nm]	22.4	30.0
Stall torque	[Nm]	5.6	7.5
Nominal rotational speed	[rpm]	3000	3000
Max. rotational speed	[rpm]	3910	3941
Motor constant	[Nm/A]	1.600	1.561
Voltage constant (phase-to-phase)	[mV/min]	102.2	101.4
Number of pole pairs		3	3
Winding resistance	[Ω]	4.6	3.2
Winding inductance	[mH]	19.8	15.0
Total output moment of inertia			
Without brake	[kgcm <sup>2</sup> ]	4.84	6.41
With brake	[kgcm <sup>2</sup> ]	5.63	7.20
Shaft load at nominal rotational speed			
Radial	[N]	650	680
Axial	[N]	130	136
Brake			
Operating voltage	[V DC]	24 +6 ... -10%	
Power	[W]	18	
Holding torque	[Nm]	9.0	
Mass moment of inertia	[kgcm <sup>2</sup> ]	0.654	

## Data sheet

Safety characteristics – Encoder									
Type	EMME-AS-...-S				EMME-AS-...-M				
Flange size	40	60	80	100	40	60	80	100	
Measuring unit	Absolute, single-turn (SEK 3 4/37)				Absolute, multi-turn (SEL 3 4/37)				
Rotor position encoder									
MTTF <sup>1)</sup>	Years	340			271				
Holding brake									
MTTF	Years	371	538	797	1037	371	538	797	1037
Switching cycles <sup>2)</sup>	5 million idle actuations								

1) Fault exclusions for the mechanical encoder connection are not possible

2) Guide value for the number of switching actuations (release/application) during exclusive use as holding brake without friction (i.e. jamming at standstill)

Technical data – Encoder				
Type	EMME-AS-...-S		EMME-AS-...-M	
Measuring unit	Absolute, single-turn (SEK 3 4/37)		Absolute, multi-turn (SEL 3 4/37)	
Operating voltage	[V DC]	7 ... 12 (±5%)		
Interface signals/protocol – HIPERFACE®				
Measuring principle	Capacitive			
Process data channel	SIN, REFSIN, COS, REFCOS (analogue differential)			
Sinusoidal/cosinusoidal periods per revolution	16			
Parameter channel	RS485 (digital)			
Absolute position values per revolution	512 (resolution 9 bits)			
Max. rotational speed				
For absolute value generation	[rpm]	6000		
Mechanical	[rpm]	12000		
Revolutions	1		4096 revolutions, 12 bits	
Interpolation of sine/cosine signals in the motor controller <sup>1)</sup>				
Measurement step at e.g. 12 bits per period	20" (angular seconds) $[360°/16/2^{12}=20"]$			
Angular accuracy	±20' (angular minutes)			

1) Dependent on the motor controller.

Weights [kg] – Encoder								
Flange size	40		60		80		100	
	S	M	S	M	S	M	S	M
Without brake	0.6	0.7	1.7	2.2	3.4	4.1	6.3	7.3
With brake	0.7	0.8	2.0	2.6	4.1	4.8	7.3	8.3

HIPERFACE® is a registered trademark of its respective trademark holder in certain countries.



## Data sheet

Safety characteristics – Encoder with SIL transmitter <sup>1)</sup>	
Type	EMME-AS-...-MX
Measuring unit	Absolute, multi-turn (SKM36S)
Rotor position encoder	
MTTFd	874 years
Performance Level (PL) to EN ISO 13849-1	Category 3, Performance Level d
Safety Integrity Level (SIL) to EN 62061, EN 61508	SIL2
PFHd	$1.3 \times 10^{-8}$
T <sub>M</sub> (duration of use)	20 years
CE marking (see declaration of conformity)	To EU EMC Directive <sup>2)</sup>

1) Related documents from SICK AG → [www.sick.com](http://www.sick.com):

- Description of HIPERFACE® Interface
- Implementation Manual on HIPERFACE® Safety
- Operating Instructions on SKM36S Stand-Alone

2) For information about the area of use, see the EC declaration of conformity: [www.festo.com/sp](http://www.festo.com/sp) → Certificates.

If the devices are subject to usage restrictions in residential, commercial or light-industrial environments, further measures for the reduction of the emitted interference may be necessary.

Technical data – Encoder with SIL transmitter	
Type	EMME-AS-...-MX
Measuring unit	Absolute, multi-turn (SKM36S)
Operating voltage [V DC]	7 ... 12 (±5%)
Interface signals/protocol – HIPERFACE®	
Measuring principle	Optical
Process data channel	SIN, REFSIN, COS, REFCOS (analogue differential)
Sinusoidal/cosinusoidal periods per revolution	128
Parameter channel	RS485 (digital)
Absolute position values per revolution	4096 (resolution 12 bits)
Max. rotational speed	
For absolute value generation [rpm]	9000
Mechanical [rpm]	9000
Revolutions	4096 revolutions, 12 bits
Interpolation of sine/cosine signals in the motor controller <sup>1)</sup>	
Measurement step at e.g. 12 bits per period	2.5" (angular seconds) $[360^\circ/128/2^{12}=2.5"]$
Angular accuracy	±20' (angular minutes)

1) Dependent on the motor controller.

Weights [kg] – Encoder with SIL transmitter						
Flange size	60		80		100	
	S	M	S	M	S	M
Without brake	1.7	2.2	3.4	4.1	6.3	7.3
With brake	2.0	2.6	4.1	4.8	7.3	8.3

HIPERFACE® is a registered trademark of its respective trademark holder in certain countries.

## Data sheet

Operating and environmental conditions		40	60	80	100
Flange size					
Standard		IEC60034			
Degree of protection		IP21			
Motor shaft		IP65			
Motor housing incl. connection technology					
Ambient temperature	[°C]	-10 ... +40 (up to 100°C with derating of 1.5% per degree Celsius)			
Storage temperature	[°C]	-20 ... +70			
Insulation class		F (155 °C)			
Temperature monitoring		Not integrated, only via I <sup>2</sup> t temperature monitoring model of the motor controller			
Rating class to EN 60034-1		S1 (continuous operation)			
Thermal class to EN 60034-1		F (155 °C)			
Relative humidity	[%]	0 ... 90 (non-condensing)			
CE marking (see declaration of conformity)		To EU EMC Directive <sup>1)</sup> To EU Low Voltage Directive To EU RoHS Directive			
UKCA marking (see declaration of conformity)		To UK instructions for EMC <sup>1)</sup> To UK regulations for electrical equipment To UK RoHS instructions			
Energy efficiency				ENEFF (CN) / Class 2	
Certification		c UL us - Recognized (OL) RCM compliance mark			
PWIS conformity		VDMA24364 zone III			
Note on materials		RoHS-compliant			

1) More information [www.festo.com/catalogue/emme](http://www.festo.com/catalogue/emme) → Support/Downloads.

### Pin allocation – Motor side

Motor (M16, pins)

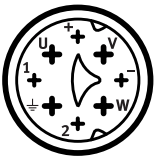

PIN	Function
U	U Phase
V	V Phase
W	W Phase
'	PE Protective earth
+	BR+ Brake
-	BR- Brake
1	n.c.
2	n.c.

Encoder (M12, pins)

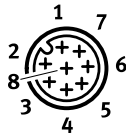

PIN	Function
1	0 V
2	Us (7 ... 12 V DC)
3	Data+ (RS485)
4	Data- (RS485)
5	SIN+
6	SIN- (REFSIN)
7	COS+
8	COS- (REFCOS)

## Data sheet

### Torque M as a function of rotational speed n

Flange size 40

Length S  
Winding LV

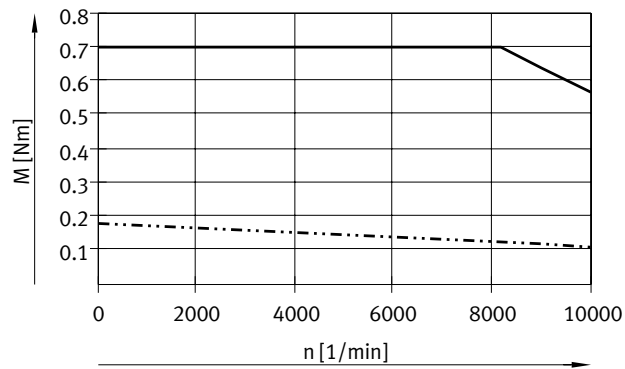

Length M  
Winding LV

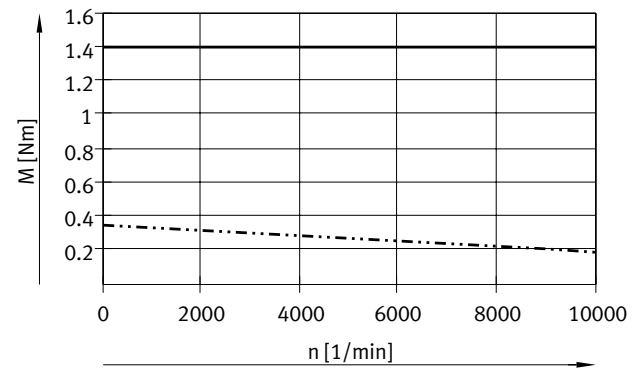

Flange size 60

Length S  
Winding LS

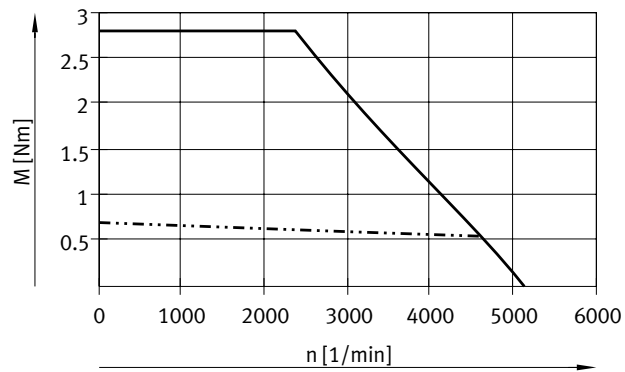

Length M  
Winding LS

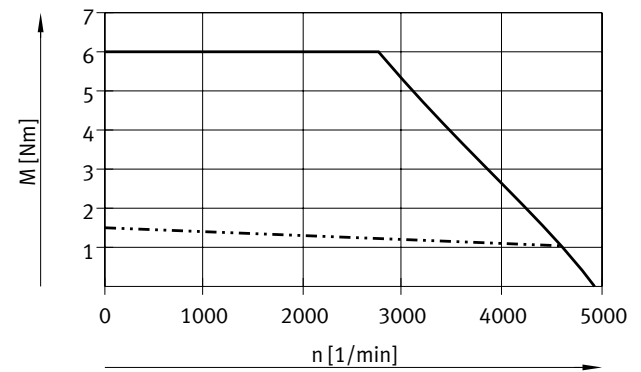

— Peak torque  
- - - Nominal torque

**Note**  
Typical motor characteristic curve with nominal voltage and optimal motor controller.

## Data sheet

### Torque M as a function of rotational speed n

Flange size 80

Length S  
Winding LS

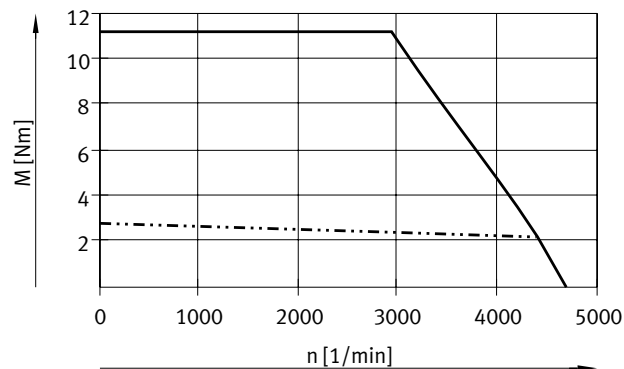

Length S  
Winding HS

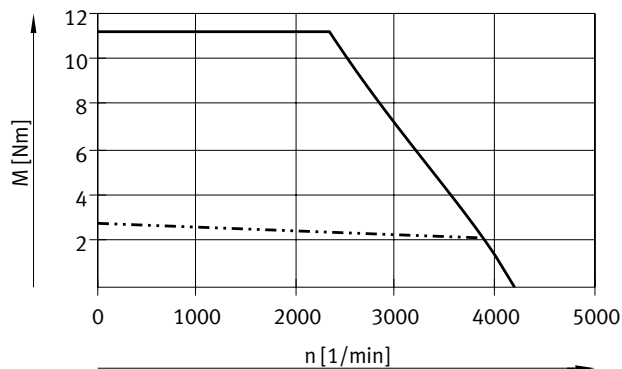

Flange size 80

Length M  
Winding LS

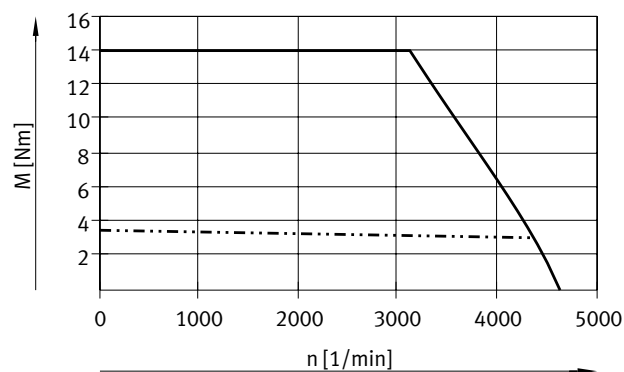

Length M  
Winding HS

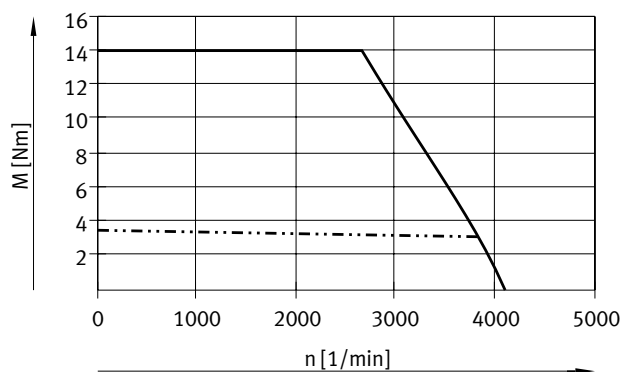

— Peak torque  
- - - - - Nominal torque

**Note**  
Typical motor characteristic curve with nominal voltage and optimal motor controller.

## Data sheet

### Torque M as a function of rotational speed n

Flange size 100

Length S  
Winding HS

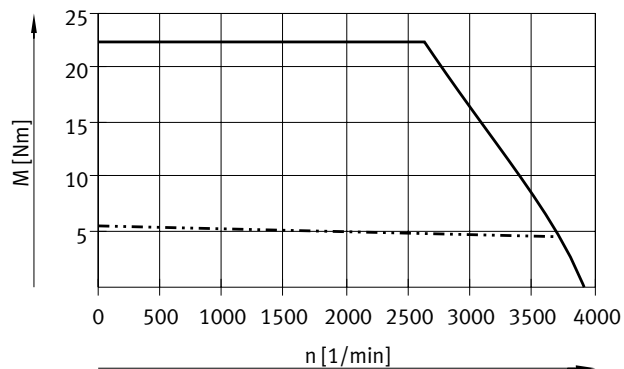

Length M  
Winding HS

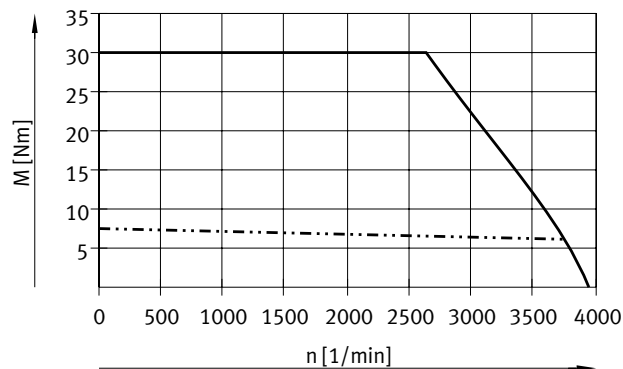

— Peak torque  
- - - Nominal torque

 **Note**  
Typical motor characteristic curve with nominal voltage and optimal motor controller.

Data sheet

Dimensions

Download CAD data → [www.festo.com](http://www.festo.com)

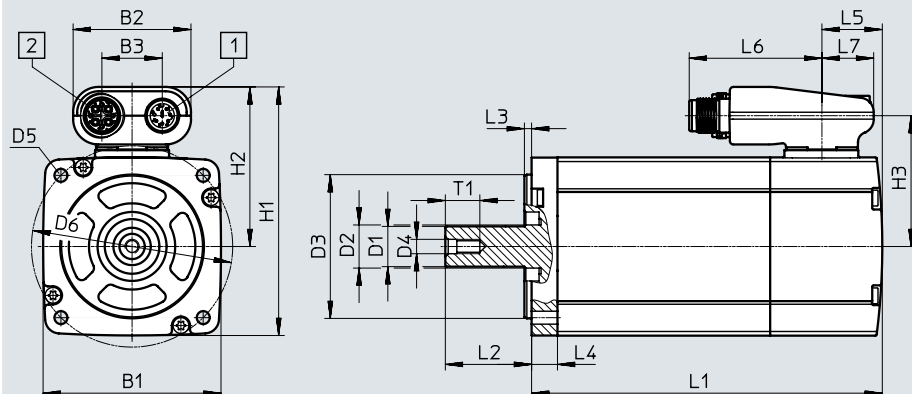

- [1] Encoder cable
- [2] Motor cable

Flange size	Length	B1	B2	B3	D1 ∅ h6	D2 ∅	D3 ∅ h7	D4
40	S	40	41	21	8	10	30	M3
	M							
60	S	62	41	21	14	15	50	M5
	M							
80	S	82	41	21	19	20	70	M6
	M							
100	S	102	41	21	19	25	95	M6
	M							

Flange size	Length	D5 ∅	D6 ∅ ±0.3	H1	H2	H3	L1	
							±2	With brake ±2
40	S	3.4	45	68.5	48.5	38.5	89	124
	M						114	149
60	S	4.5	70	86.5	55.5	45.5	122	156
	M						152	186
80	S	5.5	90	106.5	65.5	55.5	158	200
	M						178	220
100	S	9	115	126.5	75.5	65.5	200	242
	M						225	267

Flange size	Length	L2	L3 ±0.2	L4 ±0.3	L5	L6	L7	T1
	M							
60	S	30+0.5/-0.2	2.5	9	21	46.2	18	12.5
	M							
80	S	35+0.4/-0.2	3	10	23	46.2	18	16
	M							
100	S	40+0.4/-0.2	3	12	25.5	46.2	18	16
	M							

Data sheet

Dimensions – Featherkey

Download CAD data → [www.festo.com](http://www.festo.com)

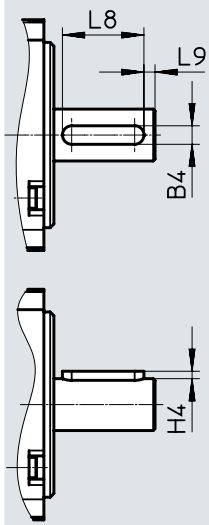

	B4	H4	L8	L9
	h9		-0,2	
EMME-AS-40-...-K	3	1.2	12	2
EMME-AS-60-...-K	5	2	22	3
EMME-AS-80-...-K	6	2.5	22	3
EMME-AS-100-...-K	6	2.5	32	4

Data sheet

Ordering data											
Length		Winding			Measuring unit			With featherkey	Brake	Part no.	Type
Short	Medium	Low voltage, standard	Low voltage, speed optimised	High voltage, standard	Encoder, single-turn	Encoder, multi-turn	Encoder, multi-turn with SIL transmitter				
<b>Flange size 40</b>											
■			■		■					☆ 2082428	EMME-AS-40-S-LV-AS
■			■		■			■		☆ 2082430	EMME-AS-40-S-LV-ASB
■			■			■				☆ 2082429	EMME-AS-40-S-LV-AM
■			■			■		■		☆ 2082431	EMME-AS-40-S-LV-AMB
	■		■		■					☆ 2082444	EMME-AS-40-M-LV-AS
	■		■		■			■		☆ 2082446	EMME-AS-40-M-LV-ASB
	■		■			■				☆ 2082445	EMME-AS-40-M-LV-AM
	■		■			■		■		☆ 2082447	EMME-AS-40-M-LV-AMB
<b>Flange size 60</b>											
■		■			■					☆ 2089698	EMME-AS-60-S-LS-AS
■		■			■			■		☆ 2089700	EMME-AS-60-S-LS-ASB
■		■				■				☆ 2089699	EMME-AS-60-S-LS-AM
■		■				■		■		☆ 2089701	EMME-AS-60-S-LS-AMB
	■	■			■					☆ 2089730	EMME-AS-60-M-LS-AS
	■	■			■			■		☆ 2089732	EMME-AS-60-M-LS-ASB
	■	■				■				☆ 2089731	EMME-AS-60-M-LS-AM
	■	■				■		■		☆ 2089733	EMME-AS-60-M-LS-AMB
<b>Flange size 80</b>											
■		■			■					☆ 2093104	EMME-AS-80-S-LS-AS
■		■			■			■		☆ 2093106	EMME-AS-80-S-LS-ASB
■		■				■				☆ 2093105	EMME-AS-80-S-LS-AM
■		■				■		■		☆ 2093107	EMME-AS-80-S-LS-AMB
■				■	■					☆ 2093136	EMME-AS-80-S-HS-AS
■				■	■			■		☆ 2093138	EMME-AS-80-S-HS-ASB
■				■		■				☆ 2093137	EMME-AS-80-S-HS-AM
■				■		■		■		☆ 2093139	EMME-AS-80-S-HS-AMB
	■	■			■					☆ 2093168	EMME-AS-80-M-LS-AS
	■	■			■			■		☆ 2093170	EMME-AS-80-M-LS-ASB
	■	■				■				☆ 2093169	EMME-AS-80-M-LS-AM
	■	■				■		■		☆ 2093171	EMME-AS-80-M-LS-AMB
	■			■	■					☆ 2093200	EMME-AS-80-M-HS-AS
	■			■	■			■		☆ 2093202	EMME-AS-80-M-HS-ASB
	■			■		■				☆ 2093201	EMME-AS-80-M-HS-AM
	■			■		■		■		☆ 2093203	EMME-AS-80-M-HS-AMB
<b>Flange size 100</b>											
■				■	■					☆ 2103467	EMME-AS-100-S-HS-AS
■				■	■			■		☆ 2103469	EMME-AS-100-S-HS-ASB
■				■		■				☆ 2103468	EMME-AS-100-S-HS-AM
■				■		■		■		☆ 2103470	EMME-AS-100-S-HS-AMB
	■			■	■					☆ 2103499	EMME-AS-100-M-HS-AS
	■			■	■			■		☆ 2103501	EMME-AS-100-M-HS-ASB
	■			■		■				☆ 2103500	EMME-AS-100-M-HS-AM
	■			■		■		■		☆ 2103502	EMME-AS-100-M-HS-AMB

Festo core product range



Generally ready for dispatch from the factory within 24 hours  
 Generally ready for dispatch from the factory within 5 days



## Data sheet

Ordering data											
Length		Winding			Measuring unit			With featherkey	Brake	Part no.	Type
Short	Medium	Low voltage, standard	Low voltage, speed optimised	High voltage, standard	Encoder, single-turn	Encoder, multi-turn	Encoder, multi-turn with SIL transmitter				
<b>Flange size 60</b>											
■		■					■			4267572	EMME-AS-60-S-LS-AMX
■		■					■	■		4267573	EMME-AS-60-S-LS-AMXB
■		■					■	■		4267574	EMME-AS-60-SK-LS-AMX
■		■					■	■	■	4267575	EMME-AS-60-SK-LS-AMXB
	■	■					■			4267576	EMME-AS-60-M-LS-AMX
	■	■					■	■		4267577	EMME-AS-60-M-LS-AMXB
	■	■					■	■		4267578	EMME-AS-60-MK-LS-AMX
	■	■					■	■	■	4267579	EMME-AS-60-MK-LS-AMXB
<b>Flange size 80</b>											
■		■					■			4267580	EMME-AS-80-S-LS-AMX
■		■					■	■		4267581	EMME-AS-80-S-LS-AMXB
■		■					■	■		4267582	EMME-AS-80-SK-LS-AMX
■		■					■	■	■	4267583	EMME-AS-80-SK-LS-AMXB
■				■			■			4267584	EMME-AS-80-S-HS-AMX
■				■			■	■		4267585	EMME-AS-80-S-HS-AMXB
■				■			■	■		4267586	EMME-AS-80-SK-HS-AMX
■				■			■	■	■	4267587	EMME-AS-80-SK-HS-AMXB
	■	■					■			4267588	EMME-AS-80-M-LS-AMX
	■	■					■	■		4267589	EMME-AS-80-M-LS-AMXB
	■	■					■	■		4267590	EMME-AS-80-MK-LS-AMX
	■	■					■	■	■	4267591	EMME-AS-80-MK-LS-AMXB
	■			■			■			4267592	EMME-AS-80-M-HS-AMX
	■			■			■	■		4267593	EMME-AS-80-M-HS-AMXB
	■			■			■	■		4267594	EMME-AS-80-MK-HS-AMX
	■			■			■	■	■	4267595	EMME-AS-80-MK-HS-AMXB
<b>Flange size 100</b>											
■				■			■			4267596	EMME-AS-100-S-HS-AMX
■				■			■	■		4267597	EMME-AS-100-S-HS-AMXB
■				■			■	■		4267598	EMME-AS-100-SK-HS-AMX
■				■			■	■	■	4267599	EMME-AS-100-SK-HS-AMXB
	■			■			■			4267600	EMME-AS-100-M-HS-AMX
	■			■			■	■		4267601	EMME-AS-100-M-HS-AMXB
	■			■			■	■		4267602	EMME-AS-100-MK-HS-AMX
	■			■			■	■	■	4267603	EMME-AS-100-MK-HS-AMXB

## Accessories

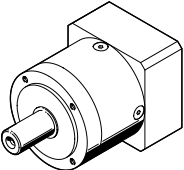
Ordering data – Planetary gear unit				Data sheets → Internet: emga
	For motor	Gear ratio	Part no.	Type
	EMME-AS-40	3	2297684	EMGA-40-P-G3-EAS-40
		5	2297685	EMGA-40-P-G5-EAS-40
		8	8141729	EMGA-40-P-G8-EAS-40
		12	8141730	EMGA-40-P-G12-EAS-40
		20	8141731	EMGA-40-P-G20-EAS-40
	EMME-AS-60	3	2297686	EMGA-60-P-G3-EAS-60
		5	2297687	EMGA-60-P-G5-EAS-60
		8	8141735	EMGA-60-P-G8-EAS-60
		12	8141736	EMGA-60-P-G12-EAS-60
		20	8141737	EMGA-60-P-G20-EAS-60
	EMME-AS-80	3	2297690	EMGA-80-P-G3-EAS-80
		5	2297691	EMGA-80-P-G5-EAS-80
		8	8141741	EMGA-80-P-G8-EAS-80
		12	8141742	EMGA-80-P-G12-EAS-80
		20	8141743	EMGA-80-P-G20-EAS-80
	EMME-AS-100	3	552194	EMGA-80-P-G3-SAS-100
		5	552195	EMGA-80-P-G5-SAS-100
		8	8141750	EMGA-80-P-G8-SAS-100
		12	8141751	EMGA-80-P-G12-SAS-100
		20	8141752	EMGA-80-P-G20-SAS-100
3		552196	EMGA-120-P-G3-SAS-100	
5		552197	EMGA-120-P-G5-SAS-100	
8		8141753	EMGA-120-P-G8-SAS-100	
12		8141754	EMGA-120-P-G12-SAS-100	
20		8141755	EMGA-120-P-G20-SAS-100	

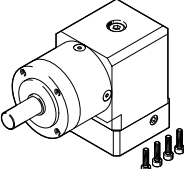
Bestellangaben – Right-angle gear unit				Data sheets → Internet: emga
	For motor	Gear ratio	Part no.	Type
	EMME-AS-40	3	8085342	EMGA-40-A-G3-40P
		5	8085343	EMGA-40-A-G5-40P
		8	8141732	EMGA-40-A-G8-40P
		12	8141733	EMGA-40-A-G12-40P
		20	8141734	EMGA-40-A-G20-40P
	EMME-AS-60	3	8085344	EMGA-60-A-G3-60P
		5	8085345	EMGA-60-A-G5-60P
		8	8141738	EMGA-60-A-G8-60P
		12	8141739	EMGA-60-A-G12-60P
		20	8141740	EMGA-60-A-G20-60P
	EMME-AS-80	3	8085346	EMGA-80-A-G3-80P
		5	8085347	EMGA-80-A-G5-80P
		8	8141744	EMGA-80-A-G8-80P
		12	8141745	EMGA-80-A-G12-80P
		20	8141746	EMGA-80-A-G20-80P
	EMME-AS-100	3	8085348	EMGA-80-A-G3-100A
		5	8085349	EMGA-80-A-G5-100A
		8	8141747	EMGA-80-A-G8-100A
		12	8141748	EMGA-80-A-G12-100A
		20	8141749	EMGA-80-A-G20-100A

Festo core product range



Generally ready for dispatch from the factory within 24 hours  
 Generally ready for dispatch from the factory within 5 days

## Accessories

Technical data – Cables		
Designation	Motor cable	
For motor	EMME-AS-4 0/60	EMME-AS-8 0/100
Type	NEBM-M16G8-...-Q7-...	NEBM-M16G8-...-Q9-...
Cable composition	2x (2x 0.25 mm <sup>2</sup> ) (3 A, 48 V, 0.5 KV)	2x (2x 0.5 mm <sup>2</sup> ) (8 A, 300 V, 2.5 KV)
	4x 0.75 mm <sup>2</sup> (12 A, 600 V, 2.5 KV)	4 x 1.5 mm <sup>2</sup> (16 A, 600 V, 2.5 KV)
	Screened	
Contamination level	3	
Min. bending radius [mm]	110	128
Ambient temperature [°C]	-50 ... +90	-50 ... +90
Ambient temperature <sup>1)</sup> [°C]	-40 ... +90	-40 ... +90
Cable characteristic	Suitable for energy chains	
Degree of protection	IP65 (in mounted state)	
Material	Polyurethane	
Note on materials	RoHS-compliant	
PWIS conformity	VDMA24364-B2-L	
CE marking (see declaration of conformity)	To EU Low Voltage Directive	
	To EU RoHS Directive	
UKCA marking (see declaration of conformity)	To UK regulations for electrical equipment	
	To UK RoHS instructions	

Designation	Encoder cable	
For motor	EMME-AS-4 0/60/8 0/100	
Type	NEBM-M12G8-...	
Cable composition	4x (2x 0.14 mm <sup>2</sup> )	
	Screened	
Contamination level	3	
Min. bending radius [mm]	68	
Ambient temperature [°C]	-40 ... +80	
Ambient temperature <sup>1)</sup> [°C]	-5 ... +80	
Cable characteristic	Suitable for energy chains	
Degree of protection	IP65 (in mounted state)	
Material	Polyurethane	
Note on materials	RoHS-compliant	
PWIS conformity	VDMA24364-B2-L	

1) With flexible cable installation

### Recommended cable cross section as a function of cable length $l$ and max. motor current $I_0$

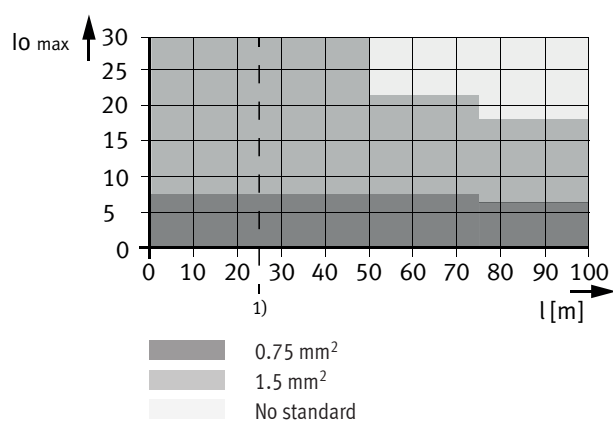

1) Cable lengths > 25 m possible following technical clarification; up to 99.9 m on request.

## Accessories

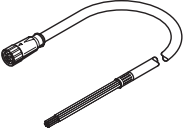
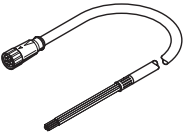
Ordering data		Cable length [m]	Part no.	Type
<b>Motor cable</b>				
	<b>For EMME-AS-4 0/60 with CMMP-AS (cable cross section: 0.75 mm<sup>2</sup>)</b>			
	2.5	★ 8004662	NEBM-M16G8-E-2.5-Q7-LE8	
	5	★ 8003770	NEBM-M16G8-E-5-Q7-LE8	
	7.5	★ 8004663	NEBM-M16G8-E-7.5-Q7-LE8	
	10	★ 8003771	NEBM-M16G8-E-10-Q7-LE8	
	15	★ 8003772	NEBM-M16G8-E-15-Q7-LE8	
	X length <sup>1)</sup>	8003773	NEBM-M16G8-E-...-Q7-LE8	
	<b>For EMME-AS-4 0/60 with CMMT-AS (cable cross section: 0.75 mm<sup>2</sup>)</b>			
	2.5	5391541	NEBM-M16G8-E-2.5-Q7-LE8-1	
	5	5391543	NEBM-M16G8-E-5-Q7-LE8-1	
	7.5	5391548	NEBM-M16G8-E-7.5-Q7-LE8-1	
	10	8085952	NEBM-M16G8-E-10-Q7-LE8-1	
	15	8085953	NEBM-M16G8-E-15-Q7-LE8-1	
	X length <sup>1)</sup>	8085954	NEBM-M16G8-E-...-Q7-LE8-1	
	<b>For EMME-AS-8 0/100 with CMMP-AS (power cable cross section: 1.5 mm<sup>2</sup>)</b>			
	2.5	★ 8004660	NEBM-M16G8-E-2.5-Q9-LE8	
	5	★ 8003766	NEBM-M16G8-E-5-Q9-LE8	
	7.5	★ 8004661	NEBM-M16G8-E-7.5-Q9-LE8	
	10	★ 8003767	NEBM-M16G8-E-10-Q9-LE8	
	15	★ 8003768	NEBM-M16G8-E-15-Q9-LE8	
	X length <sup>1)</sup>	8003769	NEBM-M16G8-E-...-Q9-LE8	
	<b>For EMME-AS-8 0/100 with CMMT-AS (power cable cross section: 1.5 mm<sup>2</sup>)</b>			
	2.5	5391540	NEBM-M16G8-E-2.5-Q9-LE8-1	
	5	5391545	NEBM-M16G8-E-5-Q9-LE8-1	
	7.5	5391547	NEBM-M16G8-E-7.5-Q9-LE8-1	
	10	5391549	NEBM-M16G8-E-10-Q9-LE8-1	
	15	5391550	NEBM-M16G8-E-15-Q9-LE8-1	
	X length <sup>1)</sup>	5392489	NEBM-M16G8-E-...-Q9-LE8-1	

1) Choice of cable lengths: 0.5 ... 99.9 m, in increments of 0.1 m.

 **Note**

Cable lengths > 25 m possible following technical clarification.  
In the case of motors with a holding brake, the max. cable length is 50 m.

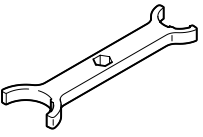
Ordering data – Spanner		Part no.	Type
	Description	8074249	EADT-S-M2
	Spanner for attaching the cables to the motor. The spanner is included in the scope of delivery of the motor cable.		

## Accessories

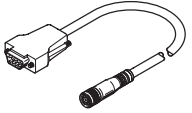
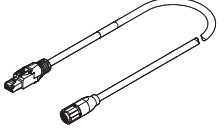
Ordering data		Cable length [m]	Part no.	Type
<b>Encoder cable</b>				
	<b>For EMME-AS-4 0/60/8 0/100 with CMMP-AS</b>			
	2.5	★ 8004664	NEBM-M12G8-E-2.5-N-S1G15	
	5	★ 8003762	NEBM-M12G8-E-5-N-S1G15	
	7.5	★ 8004665	NEBM-M12G8-E-7.5-N-S1G15	
	10 <sup>2)</sup>	★ 8003763	NEBM-M12G8-E-10-N-S1G15	
	15 <sup>2)</sup>	★ 8003764	NEBM-M12G8-E-15-N-S1G15	
X length <sup>1)2)</sup>	8003765	NEBM-M12G8-E-...-N-S1G15		
	<b>For EMME-AS-4 0/60/8 0/100 with CMMT-AS</b>			
	2.5	5212312	NEBM-M12G8-E-2.5-N-R3G8	
	5	5212313	NEBM-M12G8-E-5-N-R3G8	
	7.5	5212314	NEBM-M12G8-E-7.5-N-R3G8	
	10	5212315	NEBM-M12G8-E-10-N-R3G8	
	15	5212316	NEBM-M12G8-E-15-N-R3G8	
X length <sup>1)</sup>	5212317	NEBM-M12G8-E-...-N-R3G8		

- 1) Choice of cable lengths: 0.5 ... 99.9 m, in increments of 0.1 m.
- 2) EMC filter CAMF-C5-FC included in the scope of delivery.

**Note**

Cable lengths > 25 m possible following technical clarification.  
 In the case of motors with a holding brake, the max. cable length is 50 m.

### Ordering data – EMC filter

For cable lengths ≥ 10 m, the use of the EMC filter is recommended to reduce EMC interference.  
 For encoder cables ≥ 10 m, the filter is included in the scope of delivery of the cable.  
 The EMC filter is only required in combination with the motor controller CMMP-AS.

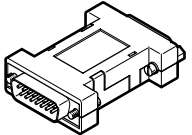
	Degree of protection	Ambient temperature	Part no.	Type
	IP30 (in mounted state)	-40 ... +80°C	4825847	CAMF-C5-FC

Festo core product range

- ★ Generally ready for dispatch from the factory within 24 hours
- ★ Generally ready for dispatch from the factory within 5 days

# Festo - Your Partner in Automation



**1 Festo Inc.**  
5300 Explorer Drive  
Mississauga, ON L4W 5G4  
Canada

**Festo Customer Interaction Center**  
Tel: 1 877 463 3786  
Fax: 1 877 393 3786  
Email: [customer.service.ca@festo.com](mailto:customer.service.ca@festo.com)



**2 Festo Pneumatic**  
Av. Ceylán 3,  
Col. Tequesquináhuac  
54020 Tlalnepantla,  
Estado de México

**Multinational Contact Center**  
01 800 337 8669  
[ventas.mexico@festo.com](mailto:ventas.mexico@festo.com)



**3 Festo Corporation**  
1377 Motor Parkway  
Suite 310  
Islandia, NY 11749

**Festo Customer Interaction Center**  
1 800 993 3786  
1 800 963 3786  
[customer.service.us@festo.com](mailto:customer.service.us@festo.com)



**4 Regional Service Center**  
7777 Columbia Road  
Mason, OH 45040

Connect with us



[www.festo.com/socialmedia](http://www.festo.com/socialmedia)



[www.festo.com](http://www.festo.com)

Subject to change