

## Guide unit EAGF

**FESTO**

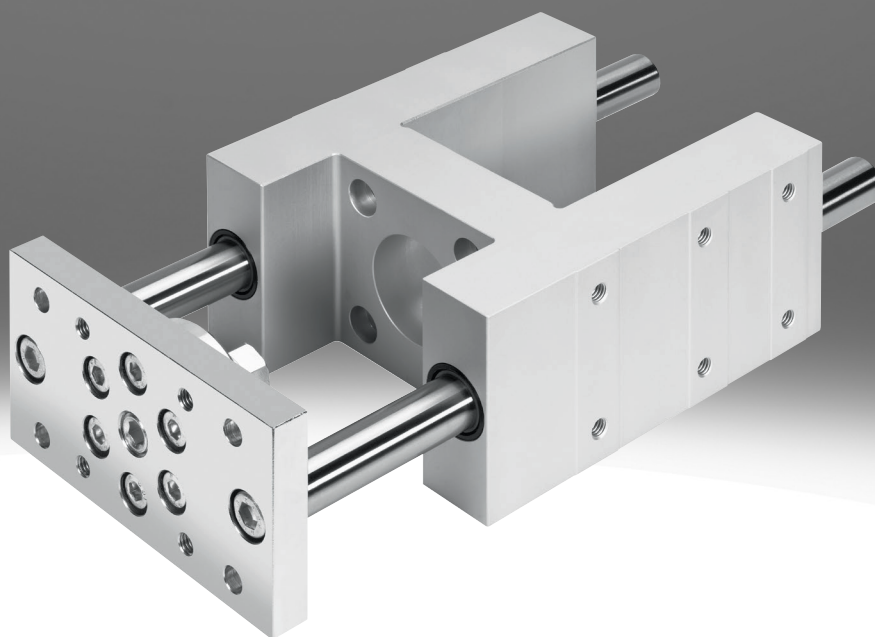

## Characteristics

### At a glance

- The guide unit EAGF provides anti-twist protection for electric cylinders in the case of high torque loads
- It offers a high level of guide precision for workpiece handling and other applications
- The interface enables simple and fast mounting on many Festo drives/axes

### Product segmentation



#### Festo Core Range

Solves the majority of your automation tasks

With the Festo Core Range, we have selected the most important products and functions from our broad product catalogue, and added the quickest delivery.

the Core Range offers you the best value with the expected high Festo quality.

- Quickest delivery, worldwide – wherever, whenever
- Expected high Festo quality
- Easy and fast to select

### Diagrams

Further information → [eagf](#)



### Allocation

[P2] Version P2 (EPCC)

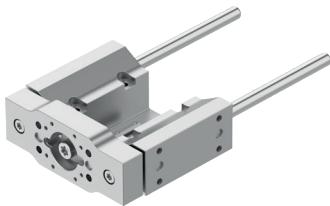

[V2] Version V2 (ESBF)

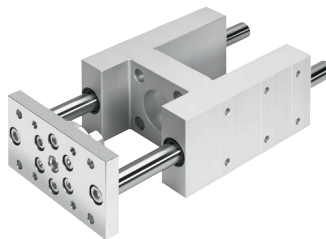

## Type code

001	Series
<b>EAGF</b>	Guide unit, for electric cylinder

002	Allocation
<b>P2</b>	Version P2 (EPCC)
<b>V2</b>	Version V2 (ESBF)

003	Guide
<b>KF</b>	Recirculating ball bearing guide

004	Size [mm]
<b>16</b>	16
<b>25</b>	25
<b>32</b>	32
<b>40</b>	40
<b>45</b>	45
<b>50</b>	50
<b>60</b>	60
<b>63</b>	63
<b>80</b>	80
<b>100</b>	100

005	Stroke [mm]
<b>50</b>	50
<b>100</b>	100
<b>150</b>	150
<b>200</b>	200
<b>300</b>	300
<b>320</b>	320
<b>400</b>	400

## Datasheet

### Guide unit EAGF, for electric cylinder EPCC

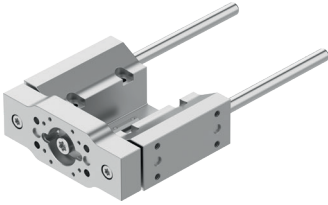

#### General technical data for EAGF-P2-KF with EPCC

Size	32	45	60
Stroke	1 ... 200 mm	1 ... 300 mm	1 ... 500 mm
Design	Guidance		
Guide	Recirculating ball bearing guide		
Displacement force	1.6 N	2 N	3 N
Max. speed	1 m/s		
Max. acceleration	25 m/s <sup>2</sup>		
Reversing backlash theoretical	0 µm		
Type of mounting	Via female thread		
Mounting position	optional		

#### Operating and environmental conditions for EAGF-P2-KF with EPCC

Size	32	45	60
Ambient temperature	0 ... 60°C		
Degree of protection	IP40		
Corrosion resistance class CRC <sup>1)</sup>	0 - No corrosion stress		

1) More information: [www.festo.com/x/topic/crc](http://www.festo.com/x/topic/crc)

#### Weights for EAGF-P2-KF with EPCC

Size	32	45	60
Basic weight for 0 mm stroke	613 g	1,037 g	1,614 g
Additional weight per 10 mm stroke	7.9 g	12.3 g	17.8 g
Moving mass for 0 mm stroke	170 g	342 g	583 g
Additional moving mass per 10 mm stroke	7.9 g	12.3 g	17.8 g

#### Centre of gravity of the moving mass for EAGF-P2-KF with EPCC

Size	32	45	60
Centre of gravity at 0 mm stroke	26 mm	25 mm	31 mm
Centre of gravity additional of moving mass per 10 mm	4.3 mm		

#### Materials for EAGF-P2-KF with EPCC

Material yoke plate	Wrought aluminium alloy, Anodised
Material housing	Wrought aluminium alloy, Anodised
Material guide component	Tempered steel, Hard-chrome-plated
Note on materials	RoHS-compliant
LABS (PWIS) conformity	VDMA24364 zone III

## Datasheet

### Characteristic load values for EAGF-P2-KF with EPCC

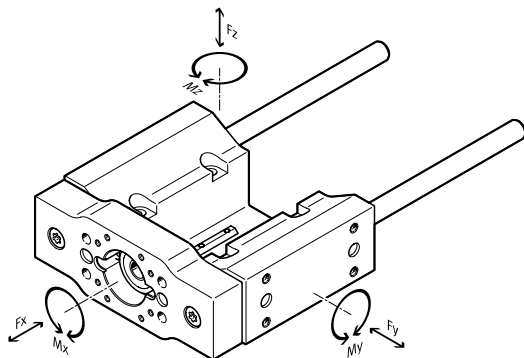

The indicated forces and torques refer to the guide centre.

Calculation example: see separate document

### Characteristic load values for EAGF-P2-KF with EPCC, static

The indicated forces and moments refer to the guide centre.

Size	32	45	60
Max. force Fy static	355 N	415 N	510 N
Max. force Fz static	355 N	415 N	510 N
Max. torque Mx static	13 Nm	19 Nm	27 Nm
Max. torque My static	9 Nm	12 Nm	20 Nm
Max. torque Mz static	9 Nm	12 Nm	20 Nm

### Characteristic load values for EAGF-P2-KF with EPCC; dynamic at a service life of 5000 km

The indicated forces and moments refer to the guide centre.

Size	32	45	60
Max. force Fy	160 N	320 N	380 N
Max. force Fz	160 N	320 N	380 N
Max. moment Mx	6 Nm	15 Nm	20 Nm
Max. moment My	4 Nm	10 Nm	15 Nm
Max. moment Mz	4 Nm	10 Nm	15 Nm

### Distance X

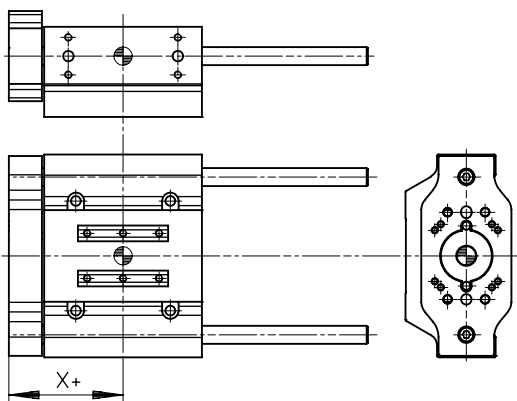

Size: 32/45/60

Distance X: 54 mm/63 mm/76 mm

### Calculating the load comparison factor for EAGF-P2-KF with EPCC

$$f_v = \frac{|F_{y1}|}{F_{y2}} + \frac{|F_{z1}|}{F_{z2}} + \frac{|M_{x1}|}{M_{x2}} + \frac{|M_{y1}|}{M_{y2}} + \frac{|M_{z1}|}{M_{z2}} \leq 1$$

If the guide unit is subjected to two or more of the indicated forces and torques at the same time, the following equation must be satisfied in addition to the indicated maximum loads.

F1 / M1 = dynamic value

F2 / M2 = maximum value

## Datasheet

### Calculation of the service life for EAGF-P2-KF with EPCC

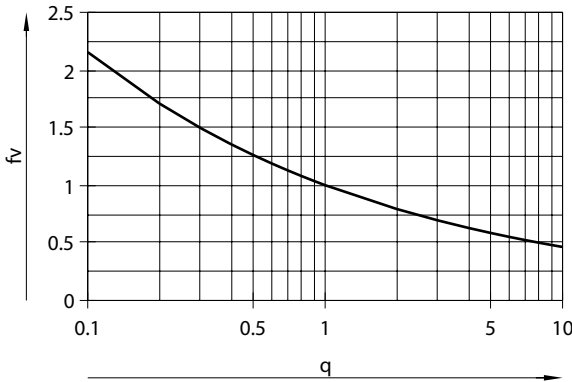

The service life of the guide depends on the load. To be able to make an approximate statement about the service life of the guide, the graph below shows the load comparison factor  $f_v$  in relation to the service life ratio  $q$ .

These values are only theoretical. You must consult your local contact person at Festo for load comparison factors  $f_v$  greater than 1.5.

Example: The effect on the service life, deviating from the specified reference service life, can be determined using the service life ratio  $q$ :

Assuming: Reference service life = 5000 km

Required service life = 3000 km

$$q = 3000 \text{ km} / 5000 \text{ km} = 0.6$$

The graph gives a load comparison factor  $f_v$  of 1.2. This means that the permissible total load can be utilised up to 120%.

$f_v > 1.5$  are only theoretical comparison values.

### Max. payload F and torque M as a function of projection A for EAGF-P2-KF with EPCC

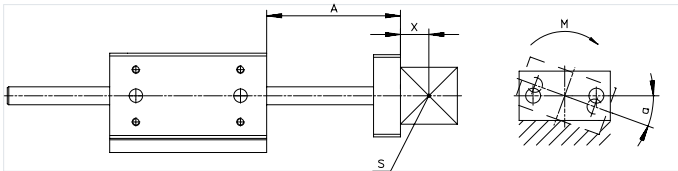

A = projection

X = distance to centre of gravity of the payload

S = centre of gravity of the payload

M = torque

### Explanation of how to read the graphs in the case of a combined load

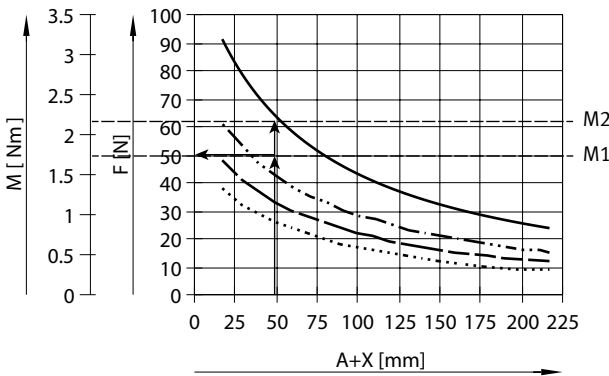

- Laufleistung 500km
- - - Laufleistung 2500km
- ■ — Laufleistung 5000km
- · · · · Laufleistung 10000km

- Determine projection (50 mm)
- Enter transverse force (50 N)
- Enter distance from curve
- Permitted torque is the difference between M2 and M1

## Datasheet

### Payload F and torque M as a function of projection A for EAGF-P2-KF-32 with EPCC

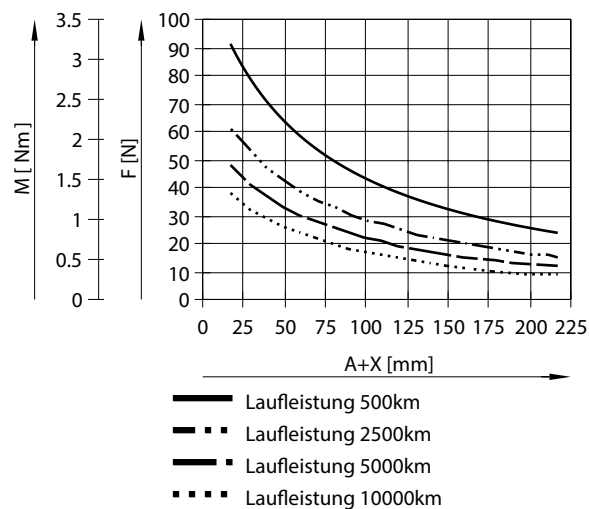

### Payload F and torque M as a function of projection A for EAGF-P2-KF-45 with EPCC

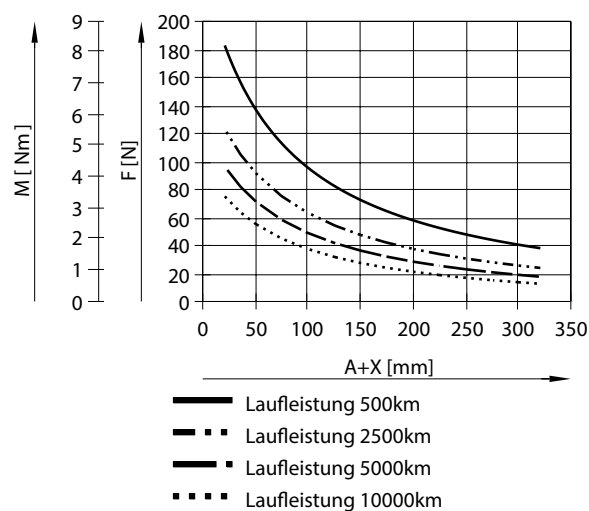

### Payload F and torque M as a function of projection A for EAGF-P2-KF-60 with EPCC

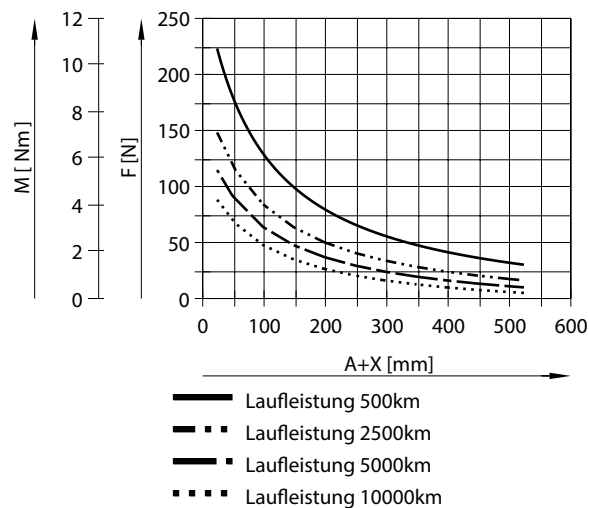

## Datasheet

### Deflection f (due to own weight) as a function of projection A for EAGF-P2-KF with EPCC

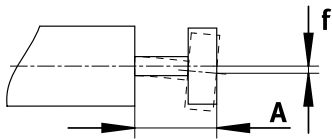

### Deflection f (due to own weight) as a function of projection A for EAGF-P2-KF with EPCC

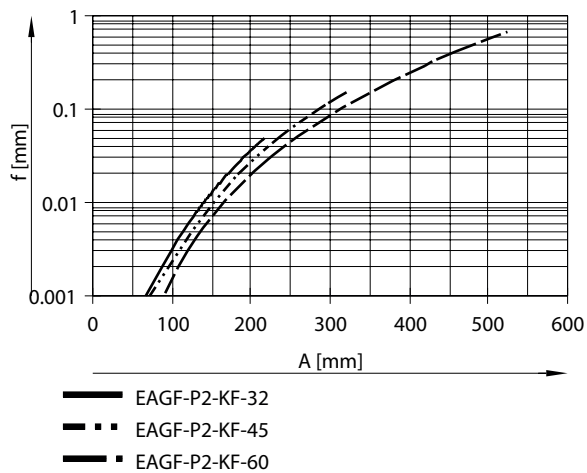

### Deflection f (due to transverse force) as a function of projection A for EAGF-P2-KF with EPCC

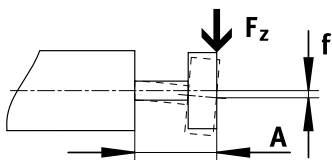

The max. permissible transverse force must not be exceeded.

$$f_1 = (F_1 / F_2) * f_2$$

$$F_2 = 10 \text{ N}$$

A = projection of guide rod

f1 = deflection due to transverse force

F1 = transverse force

F2 = standardised transverse force

f2 = deflection due to standardised transverse force (value from graph)

### Deflection f (due to transverse force) as a function of projection A for EAGF-P2-KF with EPCC

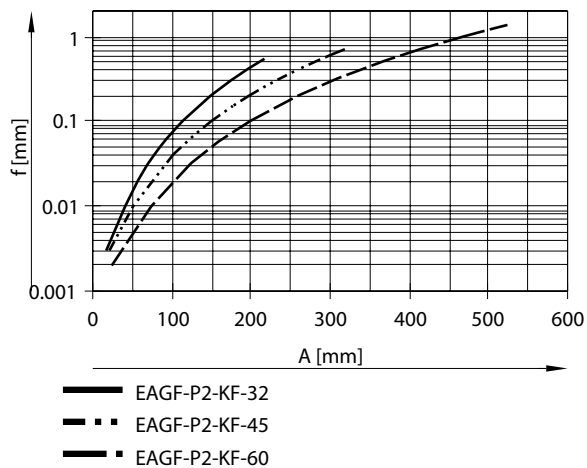



## Datasheet

### Incline $a$ (due to torque) as a function of projection $A$ for EAGF-P2-KF with EPCC

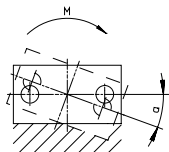

$$a_1 = (M_1 / M_2) * a_2$$

$M_2 = 2 \text{ Nm}$   
(valid for  $a \leq 10^\circ$ )

$A$  = projection of guide rod

$a_1$  = incline due to torque

$M_1$  = torque

$M_2$  = standardised torque

$a_2$  = deflection due to standardised transverse force (value from graph)

### Incline $a$ (due to torque) as a function of projection $A$ for EAGF-P2-KF with EPCC

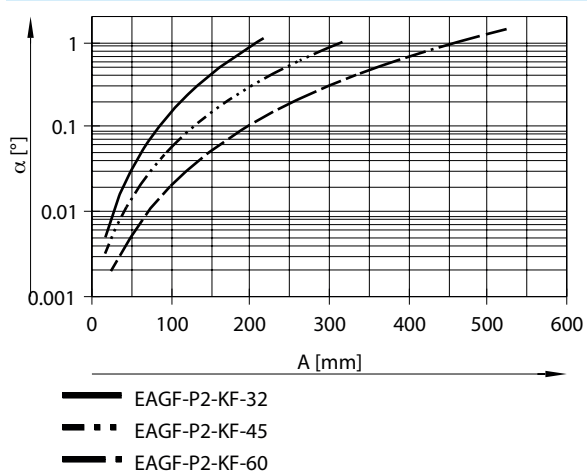

### Option to combine EAGF-P2 with EAGF-P2 by direct mounting

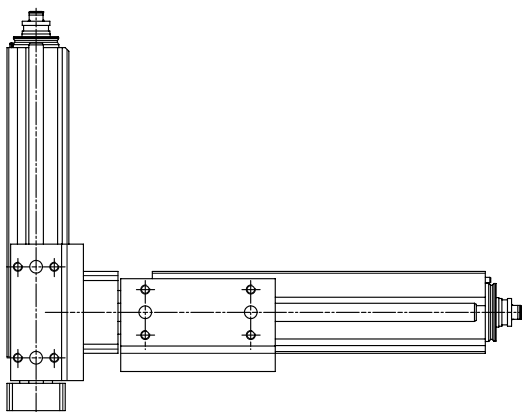

Base axis EAGF-P2-KF-45 with assembly axis EAGF-P2-KF-32

Base axis EAGF-P2-KF-60 with assembly axis EAGF-P2-KF-45

## Datasheet

### Option to combine EAGF-P2 with EGSC/EGSS using an adapter kit

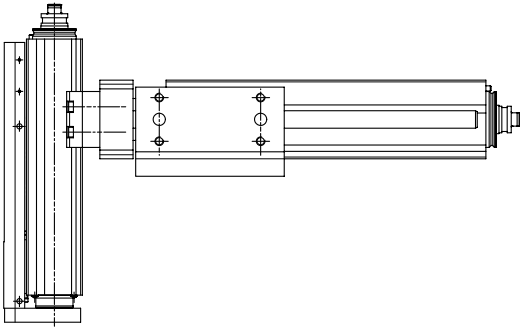

Base axis EAGF-P2-KF-32 with assembly axis EGSC/EGSS-25  
 Base axis EAGF-P2-KF-45 with assembly axis EGSC/EGSS-32  
 Base axis EAGF-P2-KF-60 with assembly axis EGSC/EGSS-45

### Option to combine ELGC/ELGS with EAGF-P2 by direct mounting

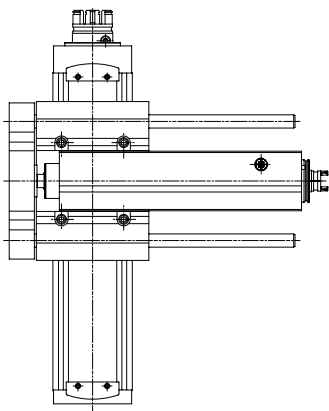

Base axis ELGC/ELGS-45 with assembly axis EAGF-P2-KF-32  
 Base axis ELGC/ELGS-60 with assembly axis EAGF-P2-KF-45  
 Base axis ELGC/ELGS-80 with assembly axis EAGF-P2-KF-60

### Option to combine EAGF-P2 with ERMO/ERMS by direct mounting

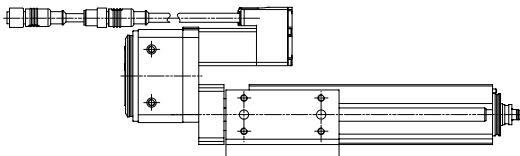

Base axis EAGF-P2-KF-32 with assembly axis ERMO/ERMS-12  
 Base axis EAGF-P2-KF-45 with assembly axis ERMO/ERMS-16  
 Base axis EAGF-P2-KF-60 with assembly axis ERMO/ERMS-25

### Guide unit EAGF, for electric cylinder ESBF

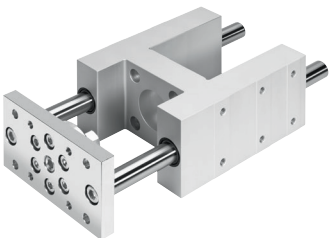

### General technical data for EAGF-V2-KF with ESBF

Size	32	40	50	63	80	100
Stroke	1 ... 500 mm				1 ... 550 mm	
Design	Guidance					
Guide	Recirculating ball bearing guide					
Displacement force	15 N				40 N	
Reversing backlash theoretical	0 µm					
Type of mounting	Via female thread					
Mounting position	optional					

## Datasheet

## Operating and environmental conditions for EAGF-V2-KF with ESBF

Size	32	40	50	63	80	100
Ambient temperature	-20 ... 80°C					
Corrosion resistance class CRC <sup>1)</sup>	0 - No corrosion stress					

1) More information: [www.festo.com/x/topic/crc](http://www.festo.com/x/topic/crc)

## Weights for EAGF-V2-KF with ESBF

Size	32	40	50	63	80	100
Basic weight for 0 mm stroke	1,685 g	2,517 g	4,059 g	5,525 g	10,517 g	13,263 g
Additional weight per 10 mm stroke	18 g	32 g	49 g		76 g	
Moving mass for 0 mm stroke	724 g	1,283 g	2,015 g	2,560 g	5,166 g	6,148 g
Additional moving mass per 10 mm stroke	18 g	32 g	49 g		76 g	

## Centre of gravity of the moving mass for EAGF-V2-KF with ESBF

Size	32	40	50	63	80	100
Centre of gravity at 0 mm stroke	30 mm	38 mm	46 mm	48 mm	54 mm	47 mm
Centre of gravity additional of moving mass per 10 mm	4.1 mm	4.2 mm	4.3 mm	4.1 mm	3.8 mm	3.6 mm

## Materials for EAGF-V2-KF with ESBF

Material yoke plate	Steel
Material housing	Wrought aluminium alloy, Anodised
Material guide component	Tempered steel
Note on materials	RoHS-compliant
LABS (PWIS) conformity	VDMA24364-B2-L

## Characteristic load values for EAGF-V2-KF with ESBF

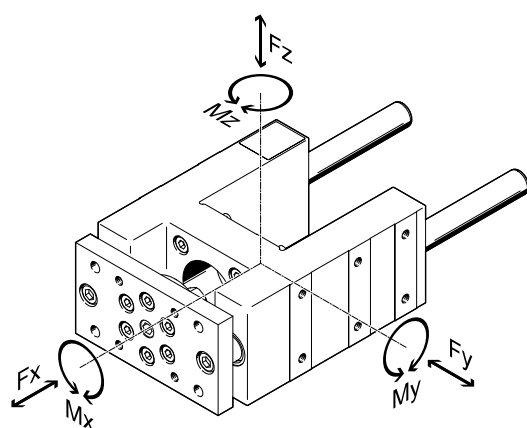

The indicated forces and torques refer to the guide centre.

Calculation example: see separate document

## Characteristic load values for EAGF-V2-KF with ESBF, static

The indicated forces and moments refer to the guide centre.

Size	32	40	50	63	80	100
Max. force Fy static	1,020 N	1,260 N	1,600 N		3,120 N	
Max. force Fz static	1,020 N	1,260 N	1,600 N		3,120 N	
Max. torque Mx static	38 Nm	55 Nm	83 Nm	95 Nm	231 Nm	268 Nm
Max. torque My static	46 Nm	65 Nm	89 Nm	115 Nm	259 Nm	267 Nm
Max. torque Mz static	46 Nm	65 Nm	89 Nm	115 Nm	259 Nm	267 Nm

## Datasheet

### Characteristic load values for EAGF-V2-KF with ESBF, dynamic at a service life of 5000 km

The indicated forces and moments refer to the guide centre.

Size	32	40	50	63	80	100
Max. force $F_y$	750 N	1,000 N	1,260 N		2,300 N	
Max. force $F_z$	750 N	1,000 N	1,260 N		2,300 N	
Max. moment $M_x$	28 Nm	44 Nm	65 Nm	75 Nm	170 Nm	198 Nm
Max. moment $M_y$	34 Nm	52 Nm	70 Nm	90 Nm	191 Nm	197 Nm
Max. moment $M_z$	34 Nm	52 Nm	70 Nm	90 Nm	191 Nm	197 Nm

### Distance X

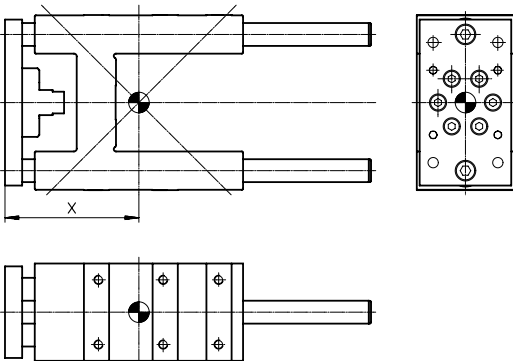

Size: 32/40/50/63/80/100

Distance X: 83 mm/85 mm/99 mm/117 mm/142 mm/145 mm

### Calculating the load comparison factor for EAGF-V2-KF with ESBF

$$f_v = \frac{|F_{y1}|}{F_{y2}} + \frac{|F_{z1}|}{F_{z2}} + \frac{|M_{x1}|}{M_{x2}} + \frac{|M_{y1}|}{M_{y2}} + \frac{|M_{z1}|}{M_{z2}} \leq 1$$

If the guide unit is subjected to two or more of the indicated forces and torques at the same time, the following equation must be satisfied in addition to the indicated maximum loads.

$F_1 / M_1$  = dynamic value

$F_2 / M_2$  = maximum value

### Calculation of the service life for EAGF-V2-KF with ESBF

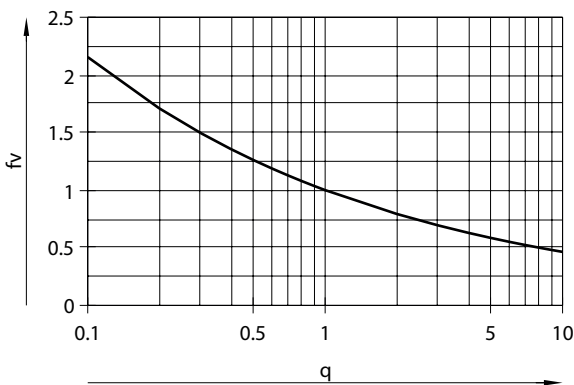

The service life of the guide depends on the load. To be able to make an approximate statement about the service life of the guide, the graph below shows the load comparison factor  $f_v$  in relation to the service life ratio  $q$ .

These values are only theoretical. You must consult your local contact person at Festo for load comparison factors  $f_v$  greater than 1.5.

Example: The effect on the service life, deviating from the specified reference service life, can be determined using the service life ratio  $q$ :

Assuming: Reference service life = 5000 km

Required service life = 3000 km

$$q = 3000 \text{ km} / 5000 \text{ km} = 0.6$$

The graph gives a load comparison factor  $f_v$  of 1.2. This means that the permissible total load can be utilised up to 120%.

$f_v > 1.5$  are only theoretical comparison values.

## Datasheet

### Max. payload F and torque M as a function of projection A for EAGF-V2-KF with ESBF

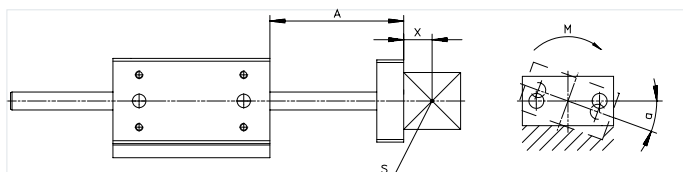

- A = projection
- X = distance to centre of gravity of the payload
- S = centre of gravity of the payload
- M = torque

### Explanation of how to read the graphs in the case of a combined load

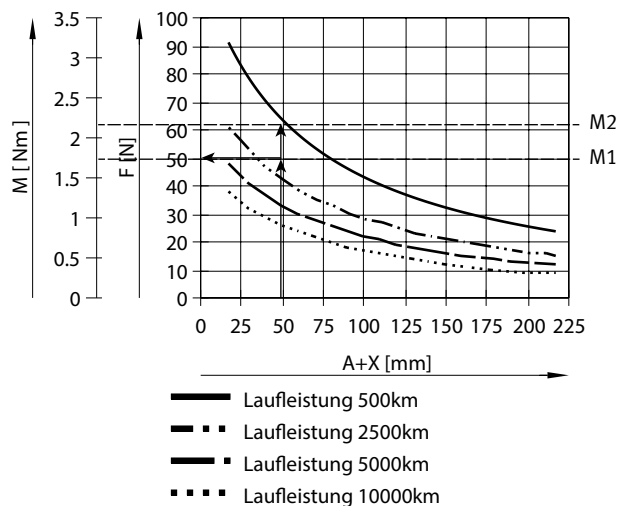

- Determine projection (50 mm)
- Enter transverse force (50 N)
- Enter distance from curve
- Permitted torque is the difference between M2 and M1

### Payload F and torque M as a function of projection A for EAGF-V2-KF-32 with ESBF

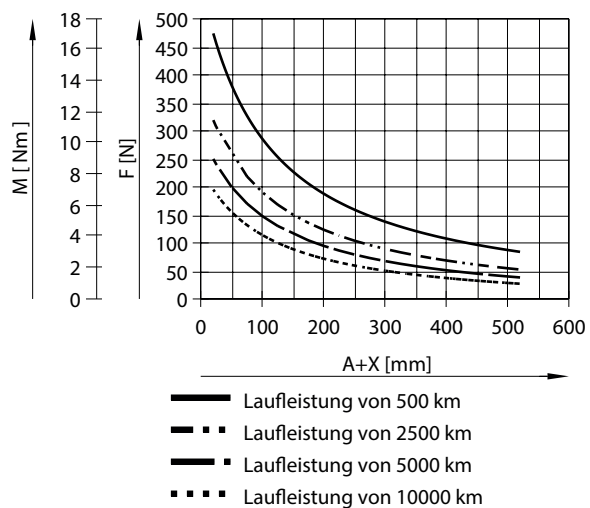

## Datasheet

### Payload F and torque M as a function of projection A for EAGF-V2-KF-40 with ESBF

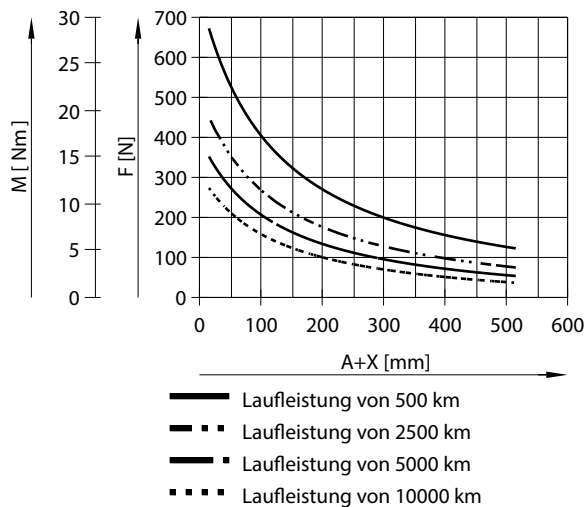

### Payload F and torque M as a function of projection A for EAGF-V2-KF-50 with ESBF

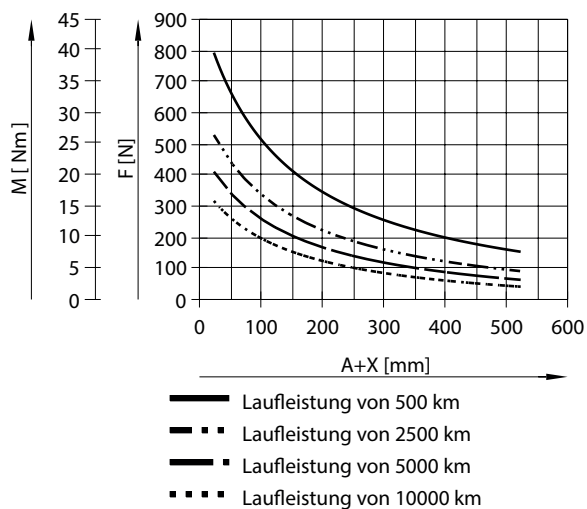

### Payload F and torque M as a function of projection A for EAGF-V2-KF-63 with ESBF

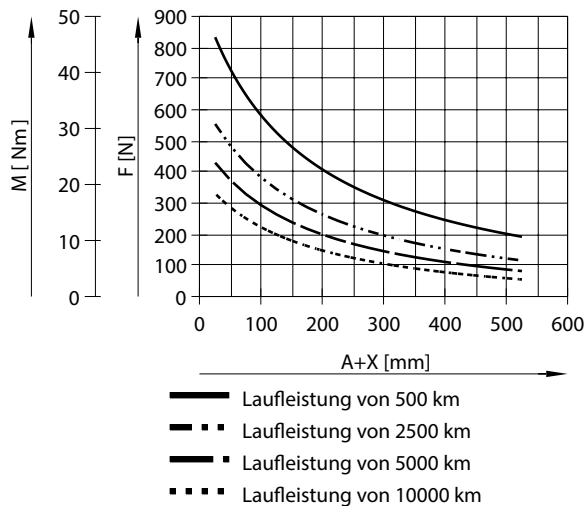

## Datasheet

### Payload F and torque M as a function of projection A for EAGF-V2-KF-80 with ESBF

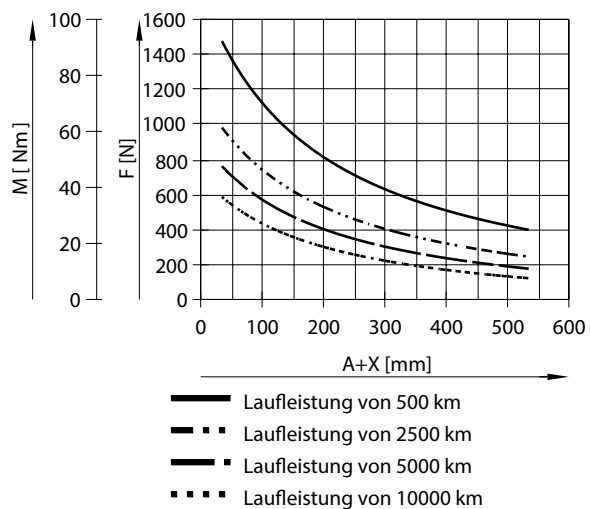

### Payload F and torque M as a function of projection A for EAGF-V2-KF-100 with ESBF

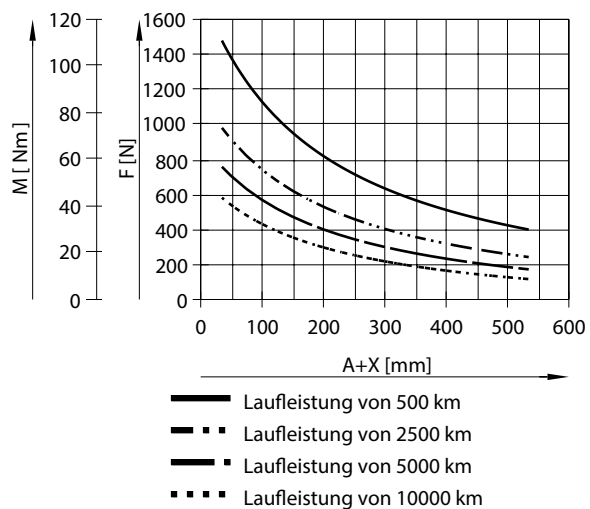

### Deflection f (due to own weight) as a function of projection A for EAGF-V2-KF with ESBF

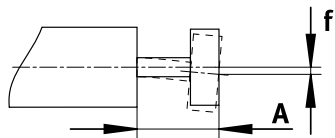

## Datasheet

### Deflection f (due to own weight) as a function of projection A for EAGF-V2-KF with ESBF

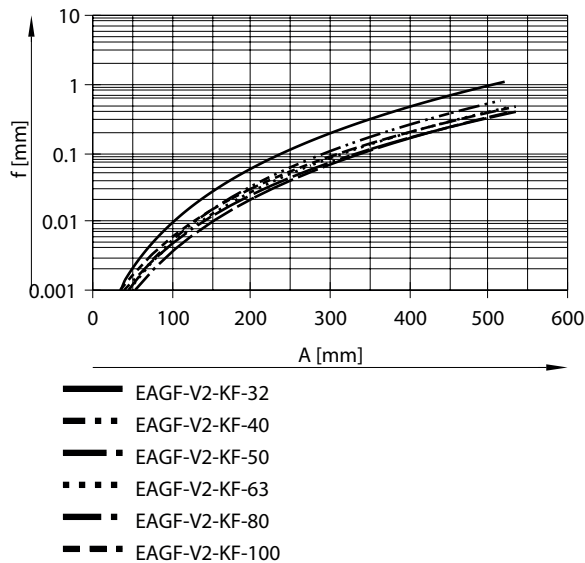

### Deflection f (due to transverse force) as a function of projection A for EAGF-V2-KF with ESBF

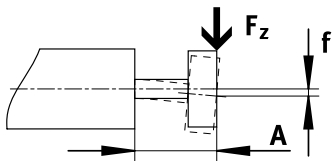

The max. permissible transverse force must not be exceeded.

$$f_1 = (F_1 / F_2) * f_2$$

$$F_2 = 10 \text{ N}$$

A = projection of guide rod

f<sub>1</sub> = deflection due to transverse force

F<sub>1</sub> = transverse force

F<sub>2</sub> = standardised transverse force

f<sub>2</sub> = deflection due to standardised transverse force (value from graph)

### Deflection f (due to transverse force) as a function of projection A for EAGF-V2-KF with ESBF

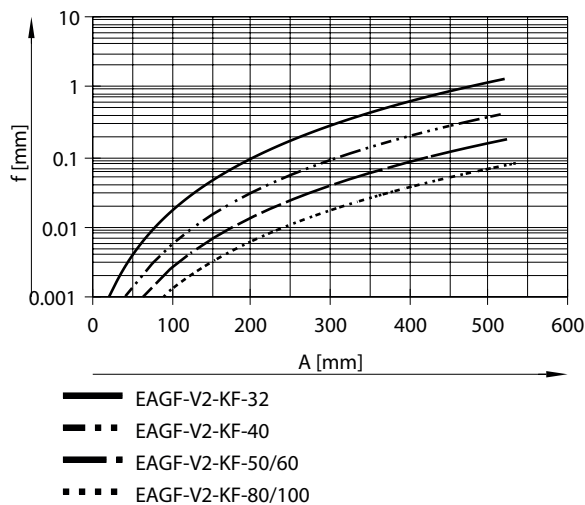



# Datasheet

## Incline $\alpha$ (due to torque) as a function of projection A for EAGF-V2-KF with ESBF

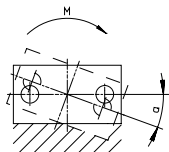

$$a_1 = (M_1 / M_2) * a_2$$

$M_2 = 2 \text{ Nm}$   
(valid for  $\alpha \leq 10^\circ$ )

A = projection of guide rod  
 $a_1$  = incline due to torque  
 M1 = torque  
 M2 = standardised torque  
 $a_2$  = deflection due to standardised transverse force (value from graph)

## Incline $\alpha$ (due to torque) as a function of projection A for EAGF-V2-KF with ESBF

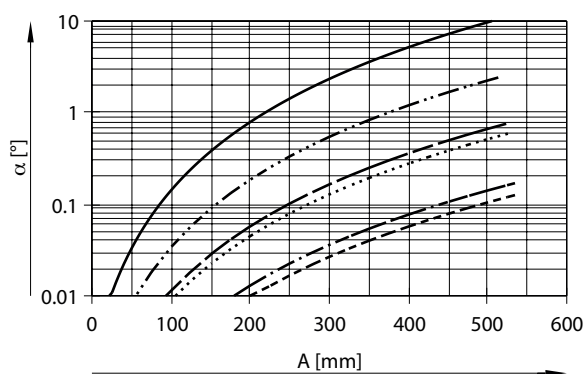

- EAGF-V2-KF-32
- - - EAGF-V2-KF-40
- ■ EAGF-V2-KF-50
- ■ ■ EAGF-V2-KF-63
- ■ ■ ■ EAGF-V2-KF-80
- ■ ■ ■ ■ EAGF-V2-KF-100

## Dimensions

Dimensions – Guide units EAGF, for electric cylinders EPCC

Download CAD data → [www.festo.com](http://www.festo.com)

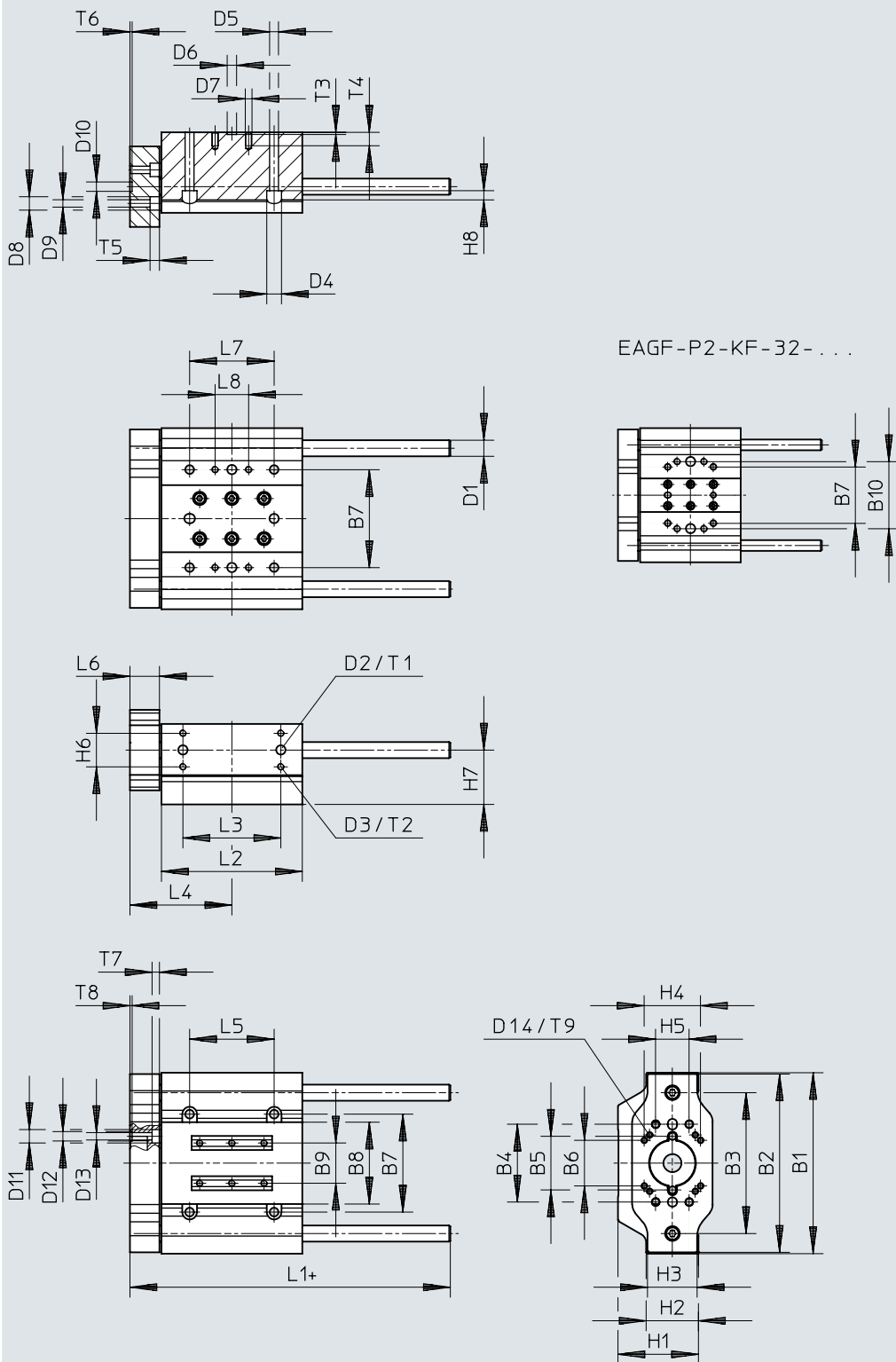

[1] += plus stroke length

## Dimensions

	B1	B2	B3	B4 ±0,1	B5 ±0,05	B6 ±0,1	B7	B8	B9	B10 ±0,05	D1 ∅	D2 ∅ H8
EAGF-32	100	98	75	50	30	24	42	33	16	50	8	7
EAGF-45	120	118	90	50	33	22,5	58	46	24	58	10	7
EAGF-60	135	133	105	58	40	34	73	61	30	73	12	7

	D3	D4 ∅	D5 ∅	D6 ∅ H8	D7	D8 ∅	D9 ∅	D10 ∅ H8	D11 ∅	D12 ∅ H8	D13 ∅	D14
EAGF-32	M5	8	4,5	7	M5	8	4,5	7	8	7	5	M3
EAGF-45	M5	10	5,5	7	M5	10	5,5	7	10	7	5,5	M3
EAGF-60	M5	11	6,6	7	M5	10	5,5	7	10	7	5,5	M4

	H1	H2	H3	H4 ±0,1	H5 ±0,05	H6 ±0,05	H7	H8	L1	L2	L3 ±0,05	L4
EAGF-32	40	28	26	24	16	20	26	4,1	102	75	50	54
EAGF-45	51	37	35	35	20	25	32,5	5,5	116	85	58	63
EAGF-60	60	39	37	42	25	25	40,5	6,9	139	105	73	76

  

	L5	L6	L7 ±0,05	L8 ±0,05	T1 +0,1	T2	T3 +0,1	T4	T5	T6 +0,1	T7	T8 +0,1	T9
EAGF-32	34	15	34	20	1,6	8,5	1,6	12	4,4	1,6	4,4	1,6	7
EAGF-45	47	19	47	25	1,6	12	1,6	12	7	1,6	5,7	1,6	7
EAGF-60	63	22	73	25	1,6	10	1,6	10	7	1,6	5,5	1,6	9

## Dimensions

Dimensions – Guide units EAGF, for electric cylinders ESBF

Download CAD data → [www.festo.com](http://www.festo.com)

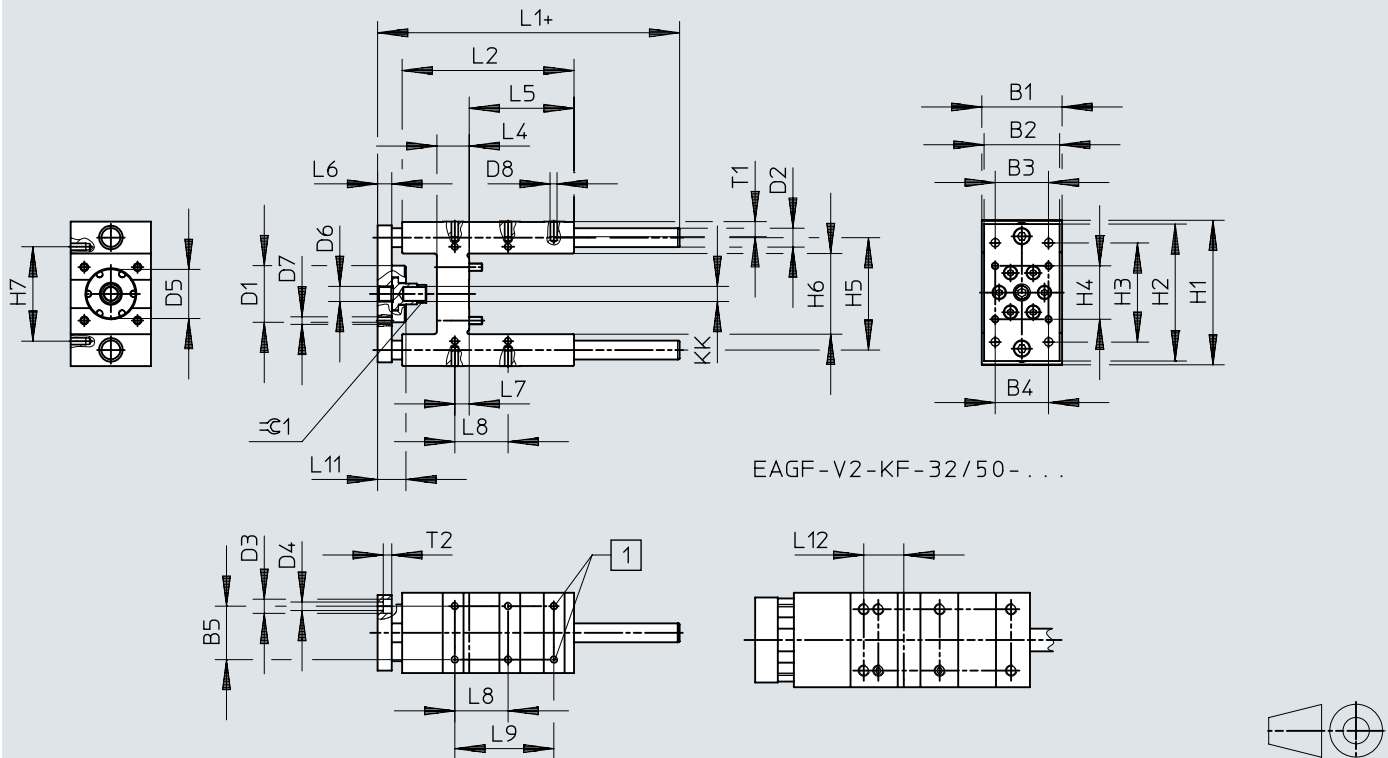

[1] These threads are omitted for size 80 and 100.

	B1	B2	B3	B4	B5	D1 ∅	D2 ∅ h6	D3 ∅	D4 ∅	D5 ∅ H8	D6	D7
	-0,3		±0,2	±0,2	±0,2							
EAGF-32	50	45	32,5	32,5	32,5	44	12	11	6,6	34	M6	M6
EAGF-40	58	54	38	38	38	48	16	11	6,6	39	M8	M6
EAGF-50	70	63	46,5	46,5	46,5	60	20	15	9	45	M8	M8
EAGF-63	85	80	56,5	56,5	56,5	60	20	15	9	52	M16	M8
EAGF-80	105	100	72	72	72	78	25	18	11	60	M18	M10
EAGF-100	130	120	89	89	89	78	25	18	11	70	M18	M10

	D8	H1	H2	H3	H4	H5	H6	H7	KK	L1	L2
		-0,5		±0,2	±0,2	±0,2		±0,2		±1	
EAGF-32	M6	97	90	78	32,5	74	50,5±0,3	61	M10x1,25	154,8	125
EAGF-40	M6	115	110	84	38	87	58,5±0,3	69	M12x1,25	172,8	140
EAGF-50	M8	137	130	100	46,5	104	70,5±0,3	85	M16x1,5	187,8	150
EAGF-63	M8	152	145	105	56,5	119	85,5±0,3	100	M16x1,5	219,8	182
EAGF-80	M10	189	180	130	72	148	106+1/-0,6	130	M20x1,5	257,8	215
EAGF-100	M10	213	200	150	89	172	131+1/-0,6	150	M20x1,5	262,8	220

	L4	L5	L6	L7	L8	L9	L11	L12	T1	T2	⊙1
					±0,2	±0,2					
EAGF-32	24	76	12	4,3	32,5	78	24	12	14	6,5	15
EAGF-40	28	81	15	11	38	84	27	-	14	6,5	15
EAGF-50	34	79	15	18,8	46,5	100	30	37	16	9	19
EAGF-63	34	111	15	15,3	56,5	105	30	-	16	9	19
EAGF-80	40	128	20	21	72	-	39	-	20	11	27
EAGF-100	40	128	20	24,5	89	-	39	-	20	11	27

## Dimensions

### Dimensions – Screw-in depth of the piston rod for the electric cylinder ESBF

Download CAD data → [www.festo.com](http://www.festo.com)

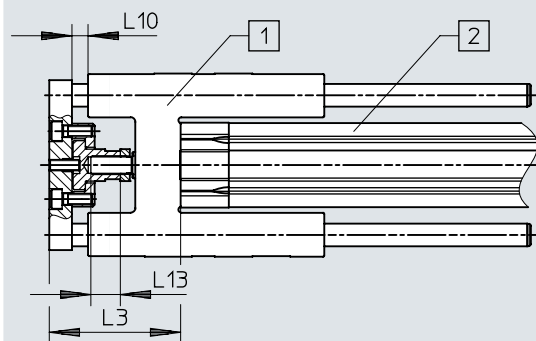

- [1] EAGF...
- [2] ESBF...
- [3] The dimensions L3 and L10 are only valid in combination with screw-in depth L13.

	L3	L10	L13
			±0,2
EAGF-32	70,2±1	9,2±1,5	15
EAGF-40	79,3±1	5,3±1,5	16
EAGF-50	96,1±0,9	10,1±1,5	24
EAGF-63	96,3±1	10,3±1,6	24
EAGF-80	121,1±1,1	14,1±1,8	30
EAGF-100	126,1±1,1	14,1±1,8	30

## Ordering data

### Guide units EAGF, for electric cylinder EPCO

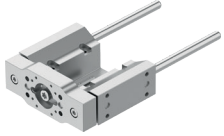
	Size	Stroke	Part no.	Type
	32	1 ... 200 mm	8158030	EAGF-P2-KF-32-
		50 mm	8158032	EAGF-P2-KF-32-50
		100 mm	8158029	EAGF-P2-KF-32-100
		150 mm	8158027	EAGF-P2-KF-32-150
		200 mm	8158028	EAGF-P2-KF-32-200
	45	1 ... 300 mm	8158133	EAGF-P2-KF-45-
		50 mm	8158131	EAGF-P2-KF-45-50
		100 mm	8158123	EAGF-P2-KF-45-100
		150 mm	8158125	EAGF-P2-KF-45-150
		200 mm	8158127	EAGF-P2-KF-45-200
	60	300 mm	8158130	EAGF-P2-KF-45-300
		1 ... 500 mm	8158150	EAGF-P2-KF-60-
		100 mm	8158138	EAGF-P2-KF-60-100
		150 mm	8158140	EAGF-P2-KF-60-150
		200 mm	8158142	EAGF-P2-KF-60-200
		300 mm	8158031	EAGF-P2-KF-60-300

### Guide units EAGF, for electric cylinder ESBF

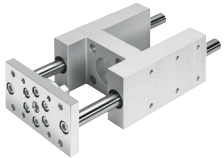
	Size	Stroke	Part no.	Type
	32	1 ... 500 mm	3038083	EAGF-V2-KF-32-
		100 mm	★ 2782679	EAGF-V2-KF-32-100
		200 mm	★ 2782818	EAGF-V2-KF-32-200
		320 mm	★ 2782885	EAGF-V2-KF-32-320
		400 mm	★ 2782923	EAGF-V2-KF-32-400
	40	1 ... 500 mm	3038089	EAGF-V2-KF-40-
		100 mm	★ 2782939	EAGF-V2-KF-40-100
		200 mm	★ 2782976	EAGF-V2-KF-40-200
		320 mm	★ 2783047	EAGF-V2-KF-40-320
		400 mm	★ 2783080	EAGF-V2-KF-40-400
	50	1 ... 500 mm	3038094	EAGF-V2-KF-50-
		100 mm	★ 2783639	EAGF-V2-KF-50-100
		200 mm	★ 2784152	EAGF-V2-KF-50-200
		320 mm	★ 2784164	EAGF-V2-KF-50-320
		400 mm	★ 2784184	EAGF-V2-KF-50-400
	63	1 ... 500 mm	2608521	EAGF-V2-KF-63-
		100 mm	★ 1725842	EAGF-V2-KF-63-100
		200 mm	★ 1725843	EAGF-V2-KF-63-200
		320 mm	★ 1725844	EAGF-V2-KF-63-320
		400 mm	★ 1725845	EAGF-V2-KF-63-400
	80	1 ... 550 mm	2608528	EAGF-V2-KF-80-
		100 mm	1725846	EAGF-V2-KF-80-100
		200 mm	1725847	EAGF-V2-KF-80-200
		320 mm	1725848	EAGF-V2-KF-80-320
		400 mm	1725849	EAGF-V2-KF-80-400
	100	1 ... 550 mm	2608532	EAGF-V2-KF-100-
		100 mm	1725850	EAGF-V2-KF-100-100
		200 mm	1725851	EAGF-V2-KF-100-200
320 mm		1725852	EAGF-V2-KF-100-320	
400 mm		1725853	EAGF-V2-KF-100-400	

## Accessories

Centring pin ZBS-4 for guide unit with electric cylinder EPCC						
	Description	Material sleeve	Size of pack	Product weight	Part no.	Type
	For size 32	High-alloy stainless steel	10	0.5 g	<b>562959</b>	<b>ZBS-4</b>

Centring sleeve ZBH-5 for guide unit with electric cylinder EPCC						
	Description	Material sleeve	Size of pack	Product weight	Part no.	Type
	For size 45	Steel	10	1 g	<b>8146543</b>	<b>ZBH-5-B</b>

Centring sleeve ZBH-7 for guide unit with electric cylinder EPCC						
	Description	Material sleeve	Size of pack	Product weight	Part no.	Type
	For sizes 32, 45, 60	Steel	10	1 g	<b>8146544</b>	<b>ZBH-7-B</b>

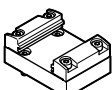
Adapter kit EHAA for guide unit with electric cylinder EPCC (for mounting the mini slide EGSC, EGSS on the yoke plate)						
	Description	Product weight	Part no.	Type		
	For size 32	56 g	<b>8158473</b>	<b>EHAA-D-L2-32-L2-25</b>		
	For size 45	60 g	<b>8066713</b>	<b>EHAA-D-L2-32-L2-32</b>		
	For size 60	136 g	<b>8066714</b>	<b>EHAA-D-L2-45-L2-45</b>		