

Stopper cylinders DFSP

FESTO



Key features

At a glance

- Versions:
 - Trunnion
 - Trunnion with female thread
 - Roller
- Single-acting, pulling
- Double-acting with spring, pulling
- Double-acting without spring
- With or without protection against rotation
- Compact design
- Sensor slots on 3 sides
- Long service life thanks to very good cushioning characteristics and sturdy piston rod guide
- Fast and simple set-up of conveyors
- Safe stopping of workpiece carriers, pallets and packages weighing up to 90 kg
- Space-saving sensing via integrated proximity switches

Trunnion version with/without protection against rotation

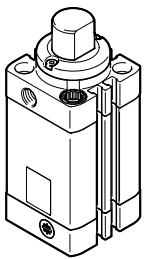

Trunnion version with female thread and with/without protection against rotation

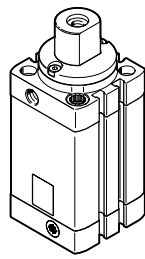

Roller version with protection against rotation

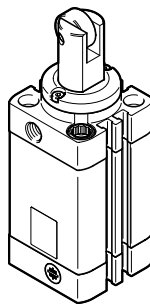

Protection against rotation

The anti-rotation ring can be rotated by 90° by loosening the screws. The compressed air can thus be connected from all 4 sides, independent of the direction of impact.

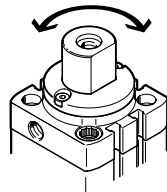

Single-acting cylinders with spring DFSP-...-P

In the variant DFSP-...-P, the cylinder can be operated as a double-acting cylinder by removing the filter nipple in the end cap.

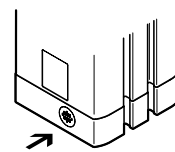

Mounting options

1 Direct mounting on the bearing cap

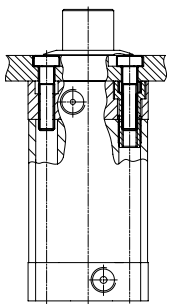

2 Direct mounting via flange mounting DAMF-F7 on the bearing cap

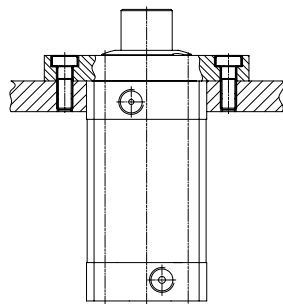

3 Through-hole mounting

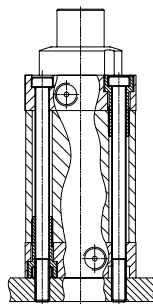

4 Direct mounting on the end cap

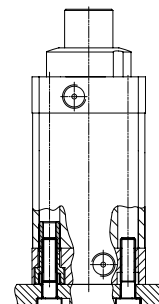

Note

All technical data refer to mounting options 1 and 2. The values can be significantly lower for the other mounting options.
Note the minimum screw-in depth → page 12

Key features

Functional sequence

Trunnion version

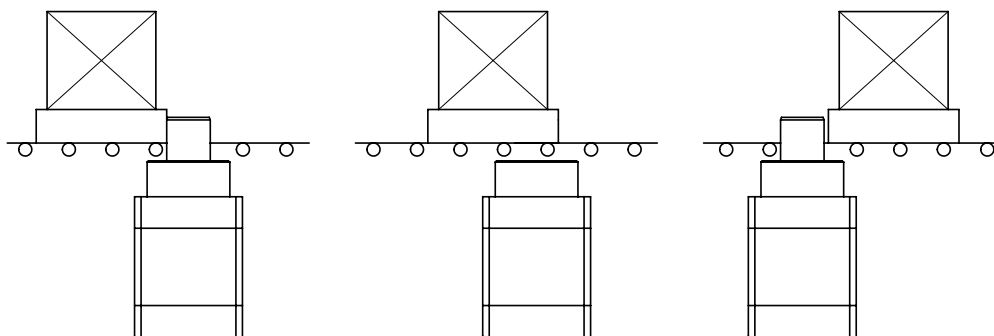

1. Sudden braking of the conveyed goods via the piston rod.
2. The conveyed goods are released by actuating the cylinder. The control system must hold the piston down until the conveyed goods have passed the stopper cylinder.
3. The piston rod is then advanced by spring force or compressed air. The next conveyed goods can then be stopped.

Roller version

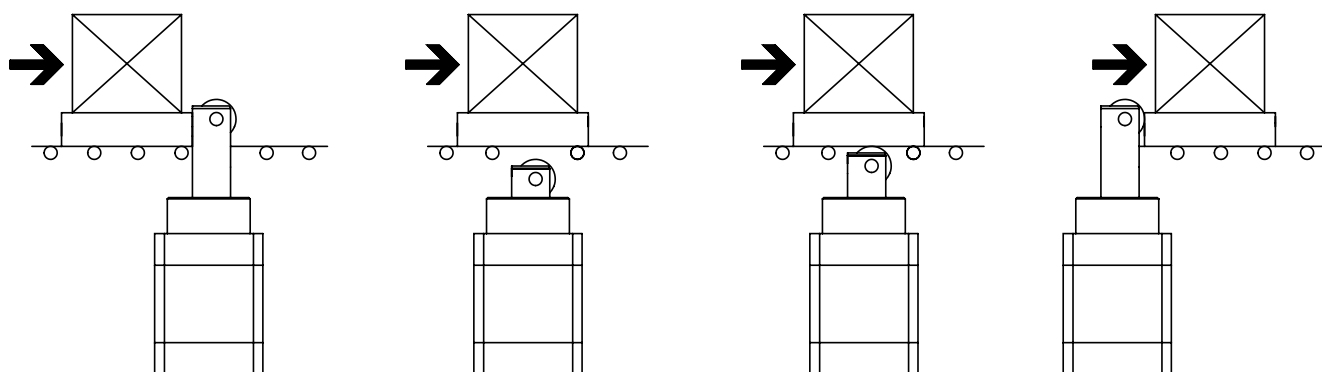

1. Sudden braking of the conveyed goods via the piston rod.
2. The conveyed goods are released by actuating the cylinder.
3. The piston rod is then advanced by spring force until the roller makes contact with the conveyed goods. The conveyed goods continue to move forward.
4. After the conveyed goods have passed, the cylinder advances to its end position. The next conveyed goods can then be stopped.

Applications and versions

Stopping large loads

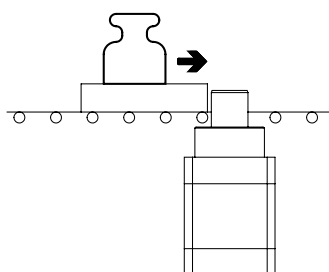

Safety

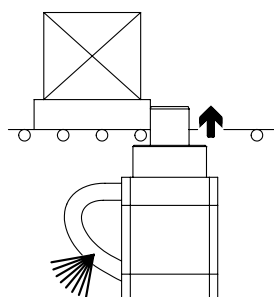

Safe stopping of conveyed goods in the event of an emergency off or pressure failure is guaranteed as the piston rod advances using spring force (single-acting/double-acting with spring).

High lateral forces on the piston rod are possible, e.g. as a result of latching or holding loads.

Product range overview

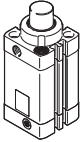
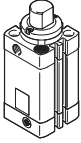
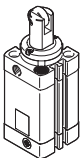
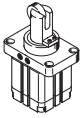
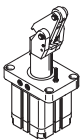
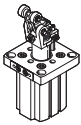
Function	Design	Type	Piston \varnothing [mm]	Stroke [mm]	Permissible impact force ¹⁾ [N]	Type of mounting		→ Page/ Internet
						Direct	Via flange	
Stopper cylinders DFSP								
Single-acting, pulling or double-acting		Trunnion DFSP-...S DFSP-...F	16	5 ... 15	880	■	■	5
			20	5 ... 20	1370	■	■	
			32	5 ... 25	3270	■	■	
			40	5 ... 30	5540	■	■	
			50	5 ... 30	6280	■	■	
		Trunnion with protection against rotation DFSP-Q-...S DFSP-Q-...F	16	5 ... 15	880	■	■	5
			20	5 ... 20	1100	■	■	
			32	5 ... 25	3270	■	■	
			40	5 ... 30	5540	■	■	
			50	5 ... 30	6280	■	■	
		Roller with protection against rotation DFSP-Q-...R	16	10, 15	710	■	■	5
			20	10, 15, 20	840	■	■	
			32	15, 20, 25	2670	■	■	
			40	20, 25, 30	4500	■	■	
			50	20, 25, 30	5000	■	■	
Stopper cylinder STAF								
Single-acting, pulling or double-acting		Roller STAF-...P-A-R	80	30, 40	14600	–	■	sta
		Toggle lever STAF-...P-A-K	32	20	480	–	■	sta
Stopper cylinders DFST								
Single-acting, pulling or double-acting		Toggle lever DFST-...-	50	30	3000	–	■	dfst
			63	30	5000			
			80	40	6000			

1) On the advanced piston rod

Type codes and peripherals overview

Type codes

001	Series
DFSP	Stopper cylinder, single- or double-acting
002	Protection against rotation
	None
Q	With protection against rotation
003	Piston diameter
16	16
20	20
32	32
40	40
50	50
004	Stroke
10	10
15	15
20	20
25	25
30	30
...	10 ... 30

005	Function
	Double-acting with spring
D	Double-acting
P	Single-acting with spring
006	Piston rod design
S	Standard
F	With female thread
R	With roller
007	Cushioning
P	Elastic cushioning rings/plates on both sides
008	Position sensing
A	For proximity sensor

Peripherals overview

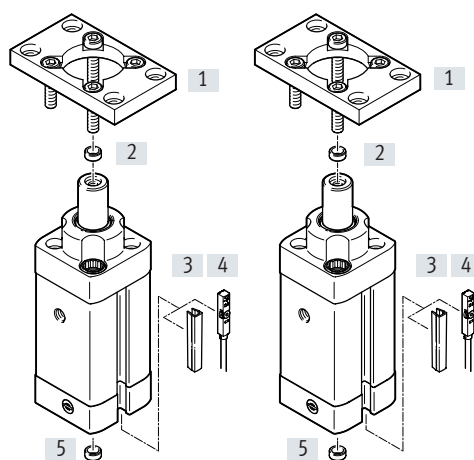

Accessories	Description	→ Page/Internet
[1] Flange mounting DAMF-F7	Mounting option via flange plate	20
[2] Centring sleeve ZBH	For precise mounting on the piston rod with female thread	21
[3] Slot cover ABP	For protection against contamination	21
[4] Proximity switch SME/SMT-8	Can be integrated into profile slot	21
[5] Centring sleeve ZBH	For the precise fitting of the stopper cylinder	21

Data sheet

⌀ - Diameter
16 ... 50 mm

┆ - Stroke length
5 ... 30 mm

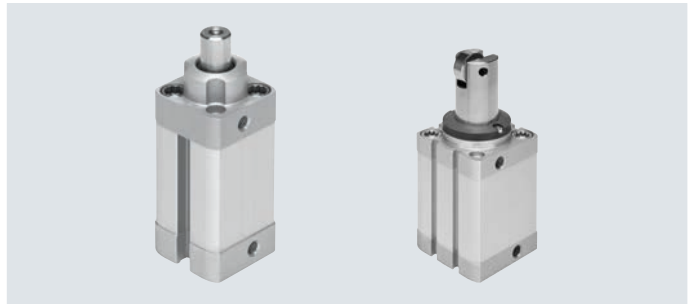

General technical data		16	20	32	40	50
Piston ø		16	20	32	40	50
Pneumatic connection		M5	M5	G1/8	G1/8	G1/8
Stroke	[mm]	5 ... 15	5 ... 20	5 ... 25	5 ... 30	5 ... 30
Max. switching frequency	[Hz]	5				
Design	Piston					
	Piston rod					
	Piston rod with roller					
	Profile barrel					
Mode of operation	Non-rotating					
	Double-acting with spring, pulling					
	Double-acting without spring					
Cushioning	Single-acting, pulling					
	Elastic cushioning rings/plates at both ends					
Type of mounting	With through-hole					
	With female thread					
	Via accessories					
Position sensing	Via proximity switch					
Mounting position	Any					

⚠ - **Note**

All technical data refer to the mounting options (→ right). The values may be much lower with the other mounting options.
Note the minimum screw-in depth → page 12

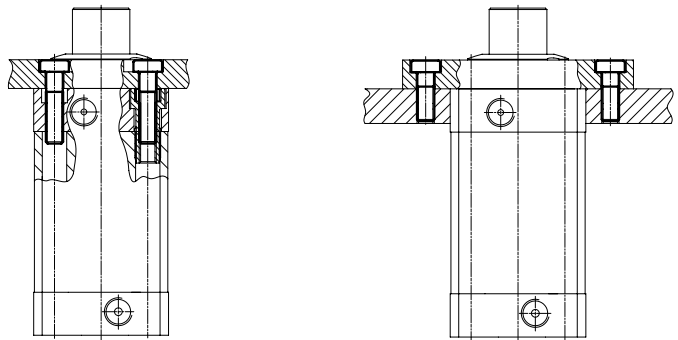

Data sheet

Operating and environmental conditions		16	20	32	40	50
Piston \varnothing						
Operating medium		Compressed air to ISO 8573-1:2010 [7:4:4]				
Note on the operating/pilot medium		Lubricated operation possible (in which case lubricated operation will always be required)				
Min. operating pressure						
Without spring	[MPa]	0.1				
	[bar]	1				
With spring	[MPa]	0.28	0.16	0.12	0.12	0.12
	[bar]	2.8	1.6	1.2	1.2	1.2
At max. lateral force	[MPa]	→ Page 10				
	[bar]					
Max. operating pressure	[MPa]	1				
	[bar]	10				
Ambient temperature ¹⁾	[°C]	-10 ... +80				
Corrosion resistance class CRC ²⁾		2				

1) Note operating range of proximity switches

2) Corrosion resistance class 2 to Festo standard 940070

Components subject to moderate corrosion stress. External visible parts with primarily decorative surface requirements which are in direct contact with the surrounding industrial environment or media such as coolants or lubricating agents.

Effective force and impact energy		16	20	32	40	50
Effective force at 0.6 MPa (6 bar), advancing						
DFSP-...	[N]	107	171	438	683	1064
DFSP-...-D	[N]	121	188	483	754	1178
Effective force at 0.6 MPa (6 bar), retracting						
DFSP-...	[N]	74	121	294	459	696
Max. impact energy of the cylinder in the end positions						
DFSP-...	[J]	0.1	0.15	0.4	0.7	1.0

Materials

Sectional view

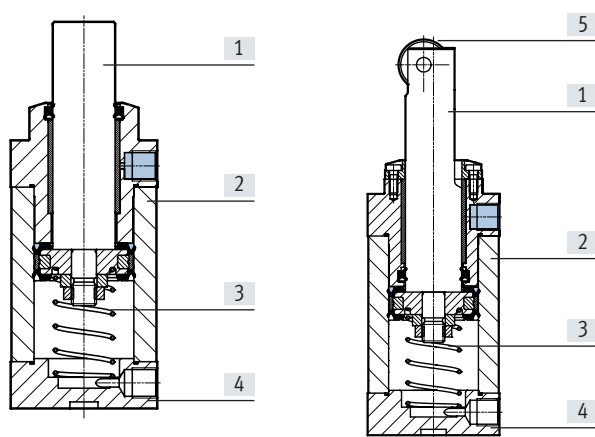

Stopper cylinder		
[1]	Piston rod	High-alloy stainless steel
[2]	Profile barrel	Smooth-anodised wrought aluminium alloy
[3]	Spring	Spring steel
[4]	Cover	Anodised wrought aluminium alloy
[5]	Roller	Galvanised steel
-	Flange screws	High-alloy stainless steel
	Seals	TPE-U(PU)
	Anti-rotation ring	POM
	Note on materials	RoHS-compliant
	PWIS conformity	VDMA24364-B1/B2-L

Data sheet

Weight [g]						
Piston ø	16	20	32	40	50	
Product weight						
with 0 mm stroke						
DFSP-...S	113	189	409	633	948	
DFSP-...F	112	188	406	626	941	
DFSP-Q-...S	111	185	402	628	937	
DFSP-Q-...F	110	184	399	621	930	
DFSP-Q-...R	113	188	419	666	1007	
Additional weight per 10 mm stroke						
DFSP-...S	16.1	24.7	45.5	68.4	99.5	
DFSP-...F						
DFSP-Q-...S	15.6	23.7	43.7	65.8	94.9	
DFSP-Q-...F						
DFSP-Q-...R						
Moving mass						
with 0 mm stroke						
DFSP-...S	30	50	156	263	436	
DFSP-...F	29	50	153	257	429	
DFSP-Q-...S	29	49	155	261	430	
DFSP-Q-...F	29	49	152	254	424	
DFSP-Q-...R	31	52	171	299	501	
Additional weight per 10 mm stroke						
DFSP-...S	6.3	9.0	25.1	39.3	64.3	
DFSP-...F						
DFSP-Q-...S	5.7	8.1	23.3	36.6	59.7	
DFSP-Q-...F						
DFSP-Q-...R						
Spring	1.3	1.4	3.5	6.4	10.6	

Stopper cylinder with protection against torsion

For the DFSP-Q-... (with anti-rotation ring), the alignment and direction of movement of the conveyed goods must be exactly perpendicular with respect to the flat impact surface of the piston rod. Conveyed goods approaching at an angle reduce the service life of the cylinder and can lead to the anti-rotation ring breaking.

The anti-rotation ring can be rotated by 90° into the desired position.

The compressed air can thus be connected from all 4 sides, independent of the direction of impact.

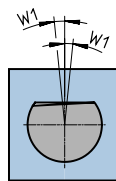
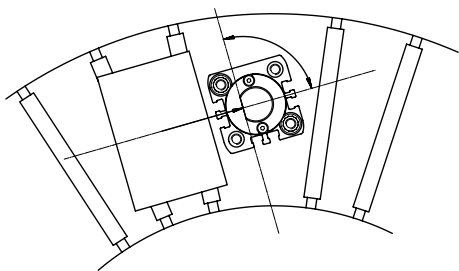

Piston ø		16	20	32	40	50
Permissible torque on the piston rod	[Nm]	1	1.5	2.5	2.5	3.5
Permissible torsional backlash W1 in new condition	[°]	±5	±4	±4	±4	±3

Data sheet

Permissible impact force on the advanced piston rod

The impact force refers to the maximum of a force curve plotted against time with unknown details during impact/braking of the moving mass. It acts perpendicular to the direction of motion of the piston rod. Treating the elastic components as linear springs, it is possible to use the permissible impact force to calculate a permissible impact energy for use in selecting the right stopper. Switching of the stopper below this force is not permitted.

Depending on the type of mass to be stopped, it is a good idea to provide an elastic buffer to cushion the impact, reduce the noise and optimise the impact energy.

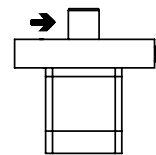

→ = direction of impact force

Piston ø		16	20	32	40	50
DFSP-...	[N]	880	1370	3270	5540	6280
DFSP-Q-...	[N]	880	1100	3270	5540	6280
DFSP-Q-...-R	[N]	710	840	2670	4500	5000

Permissible load m as a function of conveyor speed v

A prerequisite for the values in the graphs is an elastic buffer on the workpiece carrier with a deformation path of 1 mm.

A shorter deformation path reduces the impact force.

Note
Selection aid → page 22

DFSP-... / DFSP-Q-... – with trunnion

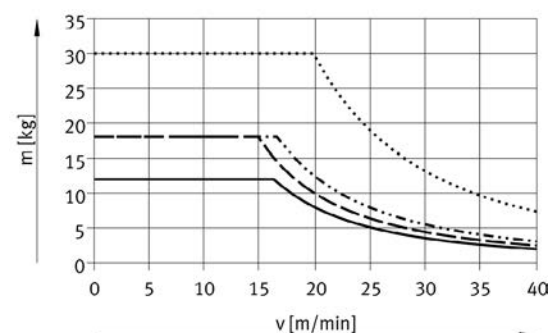

- DFSP-16/DFSP-Q-16
- DFSP-20
- - - DFSP-Q-20
- · - · DFSP-32/DFSP-Q-32

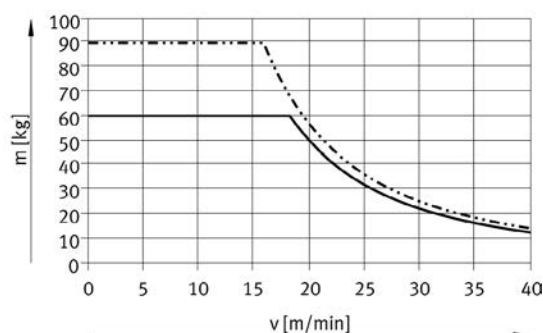

- DFSP-40/DFSP-Q-40
- DFSP-50/DFSP-Q-50

DFSP-Q-...-R – with roller

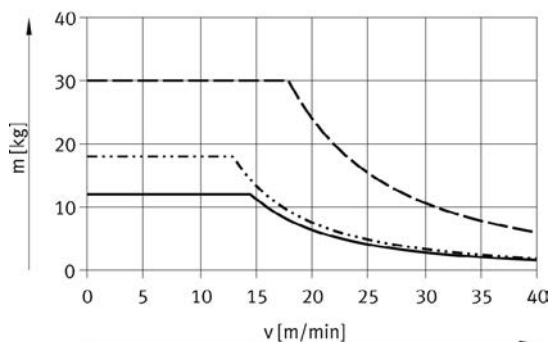

- DFSP-Q-16-R
- DFSP-Q-20-R
- - - DFSP-Q-32-R

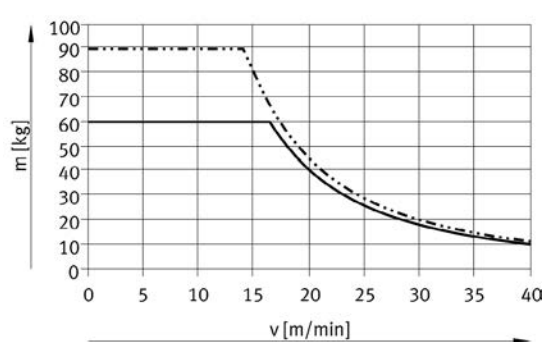

- DFSP-Q-40-R
- DFSP-Q-50-R

Data sheet

Permissible lateral force F on the advanced piston rod during switching operation

The "permissible lateral force during switching operation" refers to the force which is still applied perpendicularly to the direction of movement of the piston rod even after the end of the impact or braking process, e.g. as a result of belts that are still running or the downhill force of a steep raceway. The force acts statically. The stopper can be switched below this force. A minimum pressure must be applied in order to guarantee the cylinder function → page 6

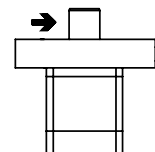

→ = direction of impact force

Piston ø		16	20	32	40	50
DFSP-...	[N]	130	210	570	950	1500
DFSP-Q-...	[N]	130	210	570	950	1500
DFSP-Q-...-R	[N]	100	160	420	750	1200

Permissible lateral force F during the switching operation as a function of the pressure p

In order to overcome the bearing friction, sufficient compressed air must be applied when switching under pressure.

If the compressed air is below 0.6 MPa (6 bar), the following graphs and the minimum operating pressure should be observed.

 **Note**
Selection aid → page 22

DFSP-... / DFSP-Q-... – with trunnion

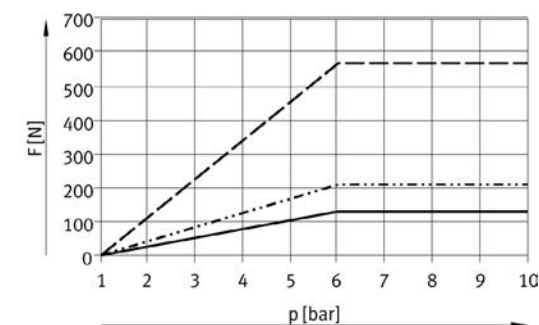

- DFSP-16
- DFSP-20
- - - DFSP-32

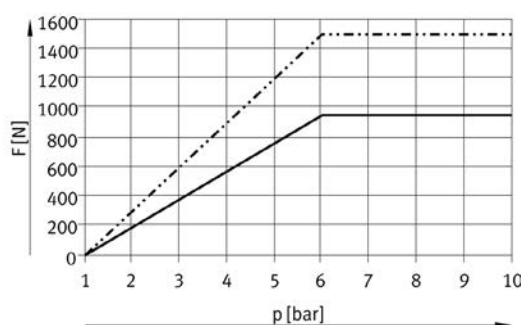

- DFSP-40
- DFSP-50

DFSP-Q-...-R – with roller

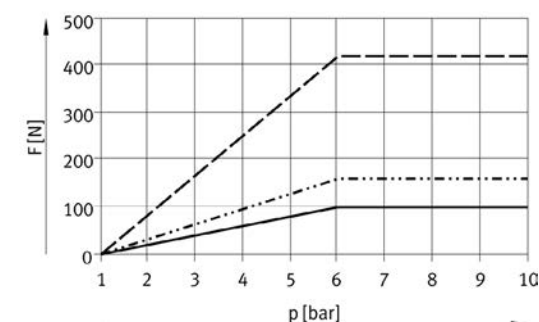

- DFSP-Q-16-R
- DFSP-Q-20-R
- - - DFSP-Q-32-R

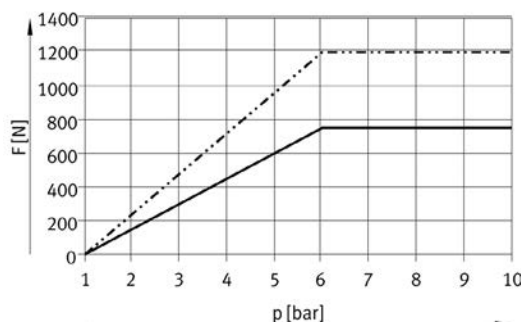

- DFSP-Q-40-R
- DFSP-Q-50-R

Data sheet

Bearing clearance of the piston rod when subjected to lateral force F

The specifications are valid for the following conditions:

- In new condition
- Without compressed air
- Max. lateral force
- Advanced piston rod

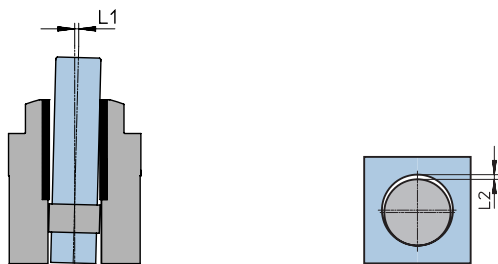

Piston \varnothing	16	20	32	40	50	
Dimension L1						
DFSP-...	[mm]	± 0.2	± 0.25	± 0.25	± 0.3	± 0.3
DFSP-Q-...	[mm]	± 0.25	± 0.3	± 0.3	± 0.3	± 0.35
Dimension L2						
Absolute bearing clearance	[mm]	± 0.1	± 0.12	± 0.14	± 0.14	± 0.17

Spring return force F as a function of stroke l

- For single-acting cylinders, the effective force is reduced compared to the theoretical force by the values for frictional and spring force
- The frictional force must be smaller than the spring force
- The friction depends on the mounting position and the type of load
- Single-acting cylinders should as far as possible be operated without lateral forces when advancing (spring force).

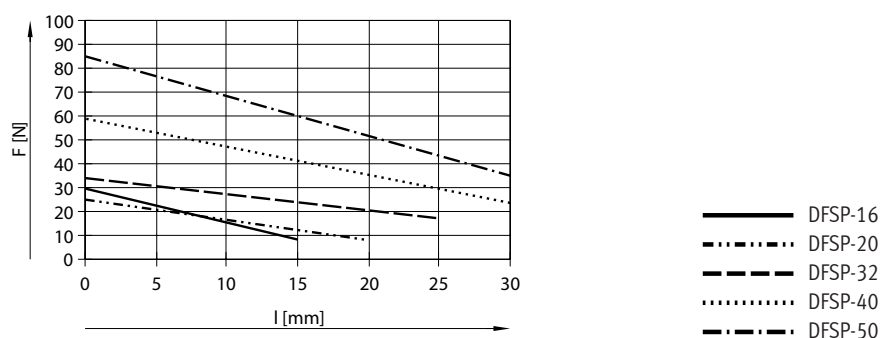

Data sheet

Dimensions

Download CAD data → www.festo.com

DFSP... – with trunnion

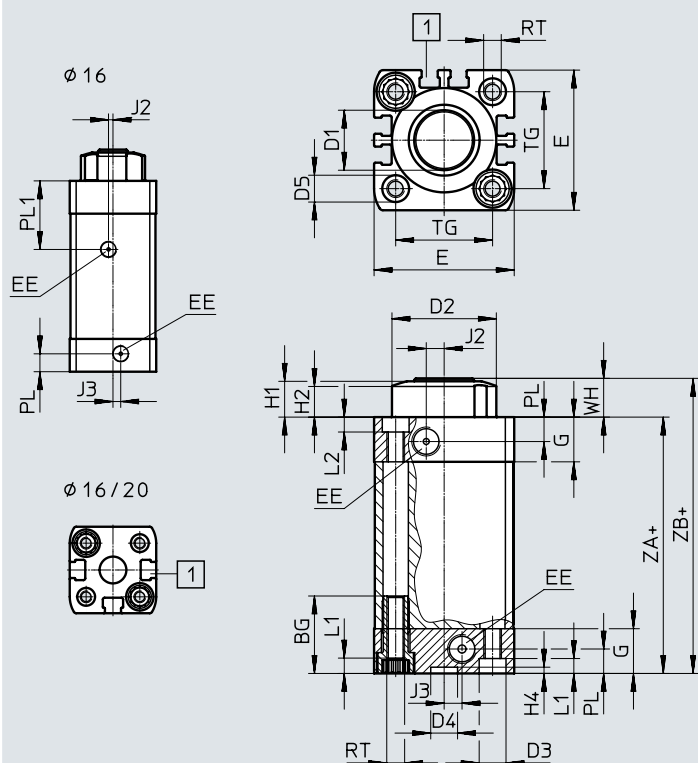

DFSP...-F
With female thread

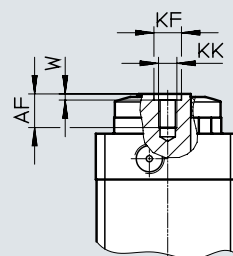

+ = plus stroke length

Dimension G = min. screw-in depth

[1] Sensor slot for proximity switch

∅	AF	BG	D1	D2	D3	D4	D5	E	EE	G	H1	H2	H4	J2
[mm]	min.	min.	∅	∅ f8	∅ F9	∅ H9	∅ F9	+0.3			±0.3	±0.3	+0.1	
16	6	17	10	21.5	6	9	6	29	M5	11	9.5	8.4	2.1	1.5
20	6	19.5	12	25	9	9	7.5	35.5	M5	12	9.5	8.4	2.1	4
32	11	26	20	35	9	9	9	47	G1/8	15	12	10.5	2.1	6
40	14.5	26	25	43	9	9	9	54.5	G1/8	15	12.5	10.5	2.1	8
50	14.5	27	32	51	12	12	10.5	65.5	G1/8	15	14.5	12.5	2.6	10

∅	J3	KF	KK	L1	L2	PL	PL1	RT	TG	W	WH	ZA	ZB
[mm]		∅ H7		+0.2	+0.2	+0.2	±0.4		±0.2	+0.1	±0.7	±0.3	±0.7
16	2.6	5	M3	3.5	3	6	23	M4	18	1.2	10.5	49	59.5
20	2.6	5	M3	5	4	6	–	M5	22	1.2	10.5	53.5	64
32	6	9	M6	5	5	8.2	–	M6	32.5	2	13	61	74
40	8	12	M8	5	5	8.2	–	M6	38	2.5	13.5	66.5	80
50	8	12	M8	5	4.2	8.2	–	M8	46.5	2.5	15.5	65.5	81

Data sheet

Dimensions

DFSP-Q... – with trunnion and protection against rotation

Download CAD data → www.festo.com

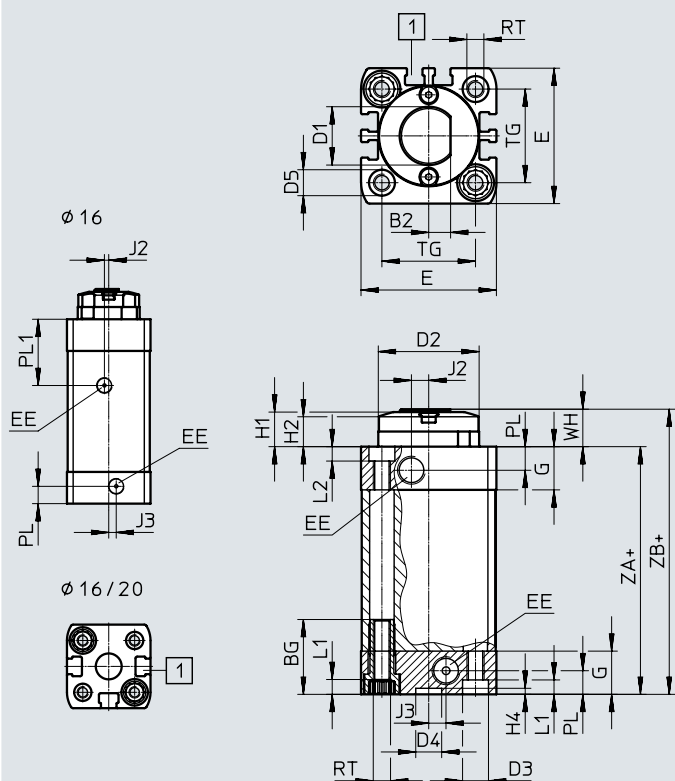

DFSP-...-F
With female thread

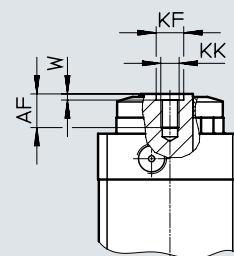

+ = plus stroke length

Dimension G = min. screw-in depth

[1] Sensor slot for proximity switch

∅	AF	B2	BG	D1	D2	D3	D4	D5	E	EE	G	H1	H2	H4
[mm]	min.	-0.15	min.	∅	∅	∅	∅	∅	+0.3			±0.3	±0.3	+0.1
16	6	3.5	17	10	21.5	6	9	6	29	M5	11	9.5	8.4	2.1
20	6	4	19.5	12	25	9	9	7.5	35.5	M5	12	9.5	8.4	2.1
32	11	7.5	26	20	35	9	9	9	47	G1/8	15	12	10.5	2.1
40	14.5	9.5	26	25	43	9	9	9	54.5	G1/8	15	12.5	10.5	2.1
50	14.5	12	27	32	51	12	12	10.5	65.5	G1/8	15	14.5	12.5	2.6

∅	J2	J3	KF	KK	L1	L2	PL	PL1	RT	TG	W	WH	ZA	ZB
[mm]			∅		+0.2	+0.2	+0.2	±0.4		±0.2	+0.1	±0.7	±0.3	±0.7
16	1.5	2.6	5	M3	3.5	3	6	23	M4	18	1.2	10.5	49	59.5
20	4	2.6	5	M3	5	4	6	-	M5	22	1.2	10.5	53.5	64
32	6	6	9	M6	5	5	8.2	-	M6	32.5	2	13	61	74
40	8	8	12	M8	5	5	8.2	-	M6	38	2.5	13.5	66.5	80
50	10	8	12	M8	5	4.2	8.2	-	M8	46.5	2.5	15.5	65.5	81

Data sheet

Dimensions

Download CAD data → www.festo.com

DFSP-Q-...-R – with roller and protection against rotation

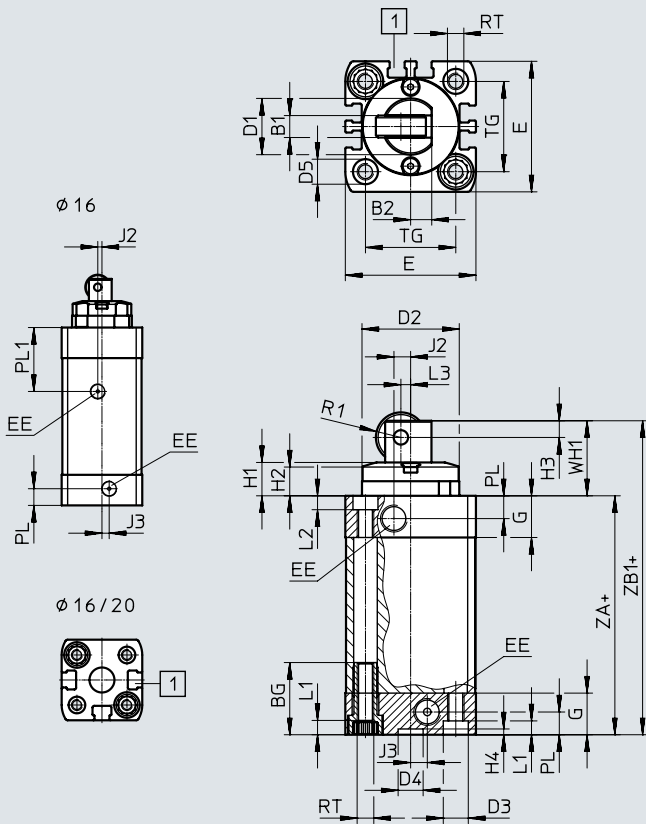

+ = plus stroke length

Dimension G = min. screw-in depth

[1] Sensor slot for proximity switch

ø	B1	B2	BG	D1	D2	D3	D4	D5	E	EE	G	H1	H2	H3
[mm]	-0.2	-0.15	min.	ø	ø f8	ø F9	ø H9	ø F9	+0.3			±0.3	±0.3	
16	3.5	3.5	17	10	21.5	6	9	6	29	M5	11	9.5	8.4	3
20	4	4	19.5	12	25	9	9	7.5	35.5	M5	12	9.5	8.4	3
32	8	7.5	26	20	35	9	9	9	47	G1/8	15	12	10.5	6
40	8	9.5	26	25	43	9	9	9	54.5	G1/8	15	12.5	10.5	7
50	10	12	27	32	51	12	12	10.5	65.5	G1/8	15	14.5	12.5	7.5

ø	H4	J2	J3	L1	L2	L3	PL	PL1	R1	RT	TG	WH1	ZA	ZB1
[mm]	+0.1			+0.2	+0.2		+0.2	±0.4			±0.2	±0.7	±0.3	±0.7
16	2.1	1.5	2.6	3.5	3	1.5	6	23	4.5	M4	18	17.5	49	66.5
20	2.1	4	2.6	5	4	2	6	-	5	M5	22	17.5	53.5	71
32	2.1	6	6	5	5	3.5	8.2	-	9	M6	32.5	27	61	88
40	2.1	8	8	5	5	5	8.2	-	11	M6	38	30.5	66.5	97
50	2.6	10	8	5	4.2	7	8.2	-	12.5	M8	46.5	34.5	65.5	100

Data sheet

Ordering data		Piston rod variant			Function			Protection against rotation	Part no.	Type
Stroke [mm]	With trunnion	With trunnion and female thread	With roller	Double-acting with spring, pulling	Double-acting without spring	Single-acting, pulling	With protection against rotation			
Piston ø 16										
10	■			■				576056	DFSP-16-10-S-PA	
	■				■			576058	DFSP-16-10-DS-PA	
	■					■		576060	DFSP-16-10-PS-PA	
		■			■			576062	DFSP-16-10-F-PA	
		■				■		576064	DFSP-16-10-DF-PA	
		■					■	576066	DFSP-16-10-PF-PA	
		■				■	■	576068	DFSP-Q-16-10-DF-PA	
				■			■	■	576070	DFSP-Q-16-10-PR-PA
15	■			■				576057	DFSP-16-15-S-PA	
	■				■			576059	DFSP-16-15-DS-PA	
	■					■		576061	DFSP-16-15-PS-PA	
		■			■			576063	DFSP-16-15-F-PA	
		■				■		576065	DFSP-16-15-DF-PA	
		■					■	576067	DFSP-16-15-PF-PA	
		■				■	■	576069	DFSP-Q-16-15-DF-PA	
				■			■	■	576071	DFSP-Q-16-15-PR-PA
Piston ø 20										
10	■			■				576072	DFSP-20-10-S-PA	
	■				■			576075	DFSP-20-10-DS-PA	
	■					■		576078	DFSP-20-10-PS-PA	
		■			■			576081	DFSP-20-10-F-PA	
		■				■		576084	DFSP-20-10-DF-PA	
		■					■	576087	DFSP-20-10-PF-PA	
		■				■	■	576090	DFSP-Q-20-10-DF-PA	
				■			■	■	576093	DFSP-Q-20-10-PR-PA
15	■			■				576073	DFSP-20-15-S-PA	
	■				■			576076	DFSP-20-15-DS-PA	
	■					■		576079	DFSP-20-15-PS-PA	
		■			■			576082	DFSP-20-15-F-PA	
		■				■		576085	DFSP-20-15-DF-PA	
		■					■	576088	DFSP-20-15-PF-PA	
		■				■	■	576091	DFSP-Q-20-15-DF-PA	
				■			■	■	576094	DFSP-Q-20-15-PR-PA
20	■			■				576074	DFSP-20-20-S-PA	
	■				■			576077	DFSP-20-20-DS-PA	
	■					■		576080	DFSP-20-20-PS-PA	
		■			■			576083	DFSP-20-20-F-PA	
		■				■		576086	DFSP-20-20-DF-PA	
		■					■	576089	DFSP-20-20-PF-PA	
		■				■	■	576092	DFSP-Q-20-20-DF-PA	
				■			■	■	576095	DFSP-Q-20-20-PR-PA

 **Note**
Additional variants → page 19

Data sheet

Ordering data									
Stroke [mm]	Piston rod variant			Function			Protection against rotation	Part no.	Type
	With trunnion	With trunnion and female thread	With roller	Double-acting with spring, pulling	Double-acting without spring	Single-acting, pulling	With protec- tion against rotation		
Piston \varnothing 32									
15	■			■				576096	DFSP-32-15-S-PA
	■				■			576099	DFSP-32-15-DS-PA
	■					■		576102	DFSP-32-15-PS-PA
		■		■				576105	DFSP-32-15-F-PA
		■			■			576108	DFSP-32-15-DF-PA
		■				■		576111	DFSP-32-15-PF-PA
		■			■		■	576114	DFSP-Q-32-15-DF-PA
				■		■	■	576117	DFSP-Q-32-15-PR-PA
20	■			■				576097	DFSP-32-20-S-PA
	■				■			576100	DFSP-32-20-DS-PA
	■					■		576103	DFSP-32-20-PS-PA
		■		■				576106	DFSP-32-20-F-PA
		■			■			576109	DFSP-32-20-DF-PA
		■				■		576112	DFSP-32-20-PF-PA
		■			■		■	576115	DFSP-Q-32-20-DF-PA
				■		■	■	576118	DFSP-Q-32-20-PR-PA
25	■			■				576098	DFSP-32-25-S-PA
	■				■			576101	DFSP-32-25-DS-PA
	■					■		576104	DFSP-32-25-PS-PA
		■		■				576107	DFSP-32-25-F-PA
		■			■			576110	DFSP-32-25-DF-PA
		■				■		576113	DFSP-32-25-PF-PA
		■			■		■	576116	DFSP-Q-32-25-DF-PA
				■		■	■	576119	DFSP-Q-32-25-PR-PA

-  - Note

Additional variants → page 19

Data sheet

Ordering data		Piston rod variant			Function			Protection against rotation	Part no.	Type
Stroke [mm]	With trunnion	With trunnion and female thread	With roller	Double-acting with spring, pulling	Double-acting without spring	Single-acting, pulling	With protection against rotation			
Piston \varnothing 40										
20	■			■				576120	DFSP-40-20-S-PA	
	■				■			576123	DFSP-40-20-DS-PA	
	■					■		576126	DFSP-40-20-PS-PA	
		■			■			576129	DFSP-40-20-F-PA	
		■				■		576132	DFSP-40-20-DF-PA	
		■					■	576135	DFSP-40-20-PF-PA	
		■				■	■	576138	DFSP-Q-40-20-DF-PA	
				■			■	■	576141	DFSP-Q-40-20-PR-PA
25	■			■				576121	DFSP-40-25-S-PA	
	■				■			576124	DFSP-40-25-DS-PA	
	■					■		576127	DFSP-40-25-PS-PA	
		■			■			576130	DFSP-40-25-F-PA	
		■				■		576133	DFSP-40-25-DF-PA	
		■					■	576136	DFSP-40-25-PF-PA	
		■				■	■	576139	DFSP-Q-40-25-DF-PA	
				■			■	■	576142	DFSP-Q-40-25-PR-PA
30	■			■				576122	DFSP-40-30-S-PA	
	■				■			576125	DFSP-40-30-DS-PA	
	■					■		576128	DFSP-40-30-PS-PA	
		■			■			576131	DFSP-40-30-F-PA	
		■				■		576134	DFSP-40-30-DF-PA	
		■					■	576137	DFSP-40-30-PF-PA	
		■				■	■	576140	DFSP-Q-40-30-DF-PA	
				■			■	■	576143	DFSP-Q-40-30-PR-PA

 **Note**
Additional variants → page 19

Data sheet

Ordering data									
Stroke [mm]	Piston rod variant			Function			Protection against rotation	Part no.	Type
	With trunnion	With trunnion and female thread	With roller	Double-acting with spring, pulling	Double-acting without spring	Single-acting, pulling	With protec- tion against rotation		
Piston \varnothing 50									
20	■			■				576144	DFSP-50-20-S-PA
	■				■			576147	DFSP-50-20-DS-PA
	■					■		576150	DFSP-50-20-PS-PA
		■		■				576153	DFSP-50-20-F-PA
		■			■			576156	DFSP-50-20-DF-PA
		■				■		576159	DFSP-50-20-PF-PA
		■			■	■	■	576162	DFSP-Q-50-20-DF-PA
25			■			■	■	576165	DFSP-Q-50-20-PR-PA
	■			■				576145	DFSP-50-25-S-PA
	■				■			576148	DFSP-50-25-DS-PA
	■					■		576151	DFSP-50-25-PS-PA
		■		■				576154	DFSP-50-25-F-PA
		■			■			576157	DFSP-50-25-DF-PA
		■				■		576160	DFSP-50-25-PF-PA
30			■			■	■	576163	DFSP-Q-50-25-DF-PA
			■			■	■	576166	DFSP-Q-50-25-PR-PA
	■			■				576146	DFSP-50-30-S-PA
	■				■			576149	DFSP-50-30-DS-PA
	■					■		576152	DFSP-50-30-PS-PA
		■		■				576155	DFSP-50-30-F-PA
		■			■			576158	DFSP-50-30-DF-PA
	■				■		576161	DFSP-50-30-PF-PA	
	■			■		■	576164	DFSP-Q-50-30-DF-PA	
			■		■	■	576167	DFSP-Q-50-30-PR-PA	

-  - Note

Additional variants → page 19

Ordering data – Modular product system

Ordering table									
Size	16	20	32	40	50	Conditions	Code	Enter code	
Module no.	575166	575167	575168	575169	575170				
Function	Stopper cylinder							DFSP	DFSP
Protection against rotation	Without								
	With protection against rotation							-Q	
Piston ø [mm]	16	20	32	40	50		-...		
Stroke [mm]	10, 15	10, 15, 20	15, 20, 25	20, 25, 30	20, 25, 30		-...		
	5 ... 15	5 ... 20	5 ... 25	5 ... 30	5 ... 30				
Function	Double-acting with spring, pulling								
	Double-acting without spring							-D	
	Single-acting with spring, pulling							-P	
Piston rod variant	Standard							S	
	With female thread							F	
	With roller						[1]	R	
Cushioning	Elastic cushioning rings/plates at both ends							-P	P
Position sensing	Via proximity switch							A	A

[1] R Only with 10, 15, 20, 25, 30 mm stroke
 Only with protection against rotation Q

Accessories

Flange mounting DAMF-F7

Material:

Galvanised steel

Free of copper and PTFE

RoHS-compliant

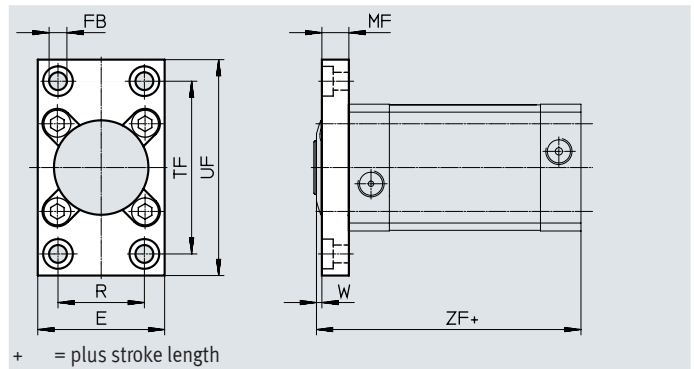

Dimensions and ordering data

For \varnothing	E	FB \varnothing	MF	R	TF	UF	W	ZF
[mm]			± 0.2	± 0.1	± 0.1		± 0.9	± 0.5
16	29	5.5	8	17	43	55	2.5	57
20	35.5	5.5	8	22	56	70	2.5	61.5
32	47	6.6	10	32	64	80	3	71
40	54.5	6.6	10	36	72	90	3.5	76.5
50	65	9	12	45	90	110	3.5	77.5



For \varnothing	Screws ¹⁾ (4x)	Tightening torque	Weight	Part no.	Type
[mm]		[Nm]			
16	DIN 912-M4x16-8.8	2.5	69	1405169	DAMF-F7-16
20	DIN 6912-M5x20-8.8	4.8	119	1405193	DAMF-F7-20
32	DIN 6912-M6x25-8.8	8	212	1405211	DAMF-F7-32
40	DIN 6912-M6x25-10.9	11	263	1405218	DAMF-F7-40
50	DIN 6912-M8x25-8.8	15	449	1405225	DAMF-F7-50



1) The screws are included in the scope of delivery of the flange mounting.



Accessories

Ordering data – Centring sleeves					
	For ø	Description	Part no.	Type	PJ ¹⁾
	16, 20	For precise mounting on the piston rod with female thread	8146543	ZBH-5-B	10
	32		8137184	ZBH-9-B	
	40, 50		8137185	ZBH-12-B	
	16, 20, 32, 40	For precise mounting of the stopper cylinder on the end cap	8137184	ZBH-9-B	
	50		8137185	ZBH-12-B	

1) Packaging unit

Ordering data – Proximity switch for T-slot, magneto-resistive						Data sheets → Internet: smt
	Type of mounting	Switching output	Electrical connection	Cable length [m]	Part no.	Type
N/O contact						
	Inserted in the slot from above, flush with the cylinder profile, short design	PNP	Cable, 3-wire	2.5	574335	SMT-8M-A-PS-24V-E-2.5-OE
			Plug M8x1, 3-pin	0.3	574334	SMT-8M-A-PS-24V-E-0.3-M8D
			Plug M12x1, 3-pin	0.3	574337	SMT-8M-A-PS-24V-E-0.3-M12
		NPN	Cable, 3-wire	2.5	574338	SMT-8M-A-NS-24V-E-2.5-OE
			Plug M8x1, 3-pin	0.3	574339	SMT-8M-A-NS-24V-E-0.3-M8D
N/C contact						
	Inserted in the slot from above, flush with the cylinder profile, short design	PNP	Cable, 3-wire	7.5	574340	SMT-8M-A-PO-24V-E-7.5-OE

Ordering data – Proximity switch for T-slot, magnetic reed						Data sheets → Internet: sme
	Type of mounting	Switching output	Electrical connection	Cable length [m]	Part no.	Type
N/O contact						
	Inserted in the slot from above, flush with the cylinder profile	Contacting	Cable, 3-wire	2.5	543862	SME-8M-DS-24V-K-2.5-OE
				5.0	543863	SME-8M-DS-24V-K-5.0-OE
			Cable, 2-wire	2.5	543872	SME-8M-ZS-24V-K-2.5-OE
				0.3	543861	SME-8M-DS-24V-K-0.3-M8D
	Inserted in the slot lengthwise, flush with the cylinder profile	Contacting	Cable, 3-wire	2.5	150855	SME-8-K-LED-24
			Plug M8x1, 3-pin	0.3	150857	SME-8-S-LED-24
N/C contact						
	Inserted in the slot lengthwise, flush with the cylinder profile	Contacting	Cable, 3-wire	7.5	160 251	SME-8-O-K-LED-24

Ordering data – Connecting cables						Data sheets → Internet: nebu
	Electrical connection, left	Electrical connection, right	Cable length [m]	Part no.	Type	
	Straight socket, M8x1, 3-pin	Cable, open end, 3-wire	2.5	541333	NEBU-M8G3-K-2.5-LE3	
			5	541334	NEBU-M8G3-K-5-LE3	
	Angled socket, M8x1, 3-pin	Cable, open end, 3-wire	2.5	541338	NEBU-M8W3-K-2.5-LE3	
			5	541341	NEBU-M8W3-K-5-LE3	

Ordering data – Slot cover for T-slot					
	Mounting	Length [m]	Part no.	Type	
	Insertable	2x 0.5	151680	ABP-5-S	

Data sheet

Selection aid

Stopping a pallet

The stopper cylinder is used to brake an individual pallet.

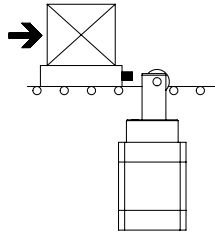

Example

Assuming:

Friction factor $\mu = 0.1$

Conveyor speed $v = 15 \text{ m/min}$

Pallet with workpiece $m = 40 \text{ kg}$

Operating pressure $p = 0.6 \text{ MPa (6 bar)}$

Spring travel of the pallet buffer $s_F = 1 \text{ mm}$

Selection: Stopper cylinders DFSP-Q-40-...-R

1. Checking the permissible load

The maximum permissible load at a conveyor speed of 15 m/min is 60 kg. This means that a total load of 40 kg for the pallet and the workpiece is permissible.

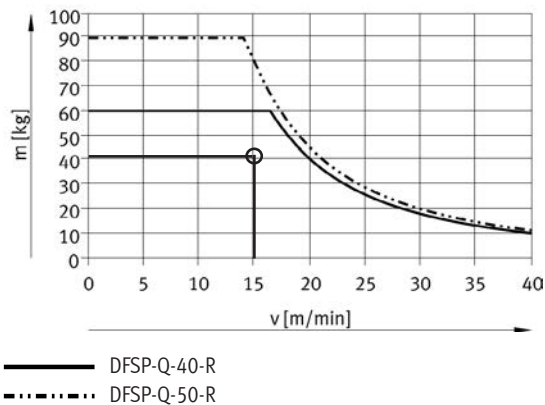

2. Checking the permissible lateral force during the switching operation

Lateral force $F_Q = \text{frictional force } F_{\text{friction}}$

$$\begin{aligned}
 F_{\text{friction}} &= \mu \times m \times g \\
 &= 0.1 \times 40 \text{ kg} \times 9.81 \text{ m/s}^2 \\
 &= \text{approx. } 40 \text{ N}
 \end{aligned}$$

The maximum permissible lateral force at an operating pressure of 6 bar is 750 N.

This means that the lateral force of 40 N is permissible.

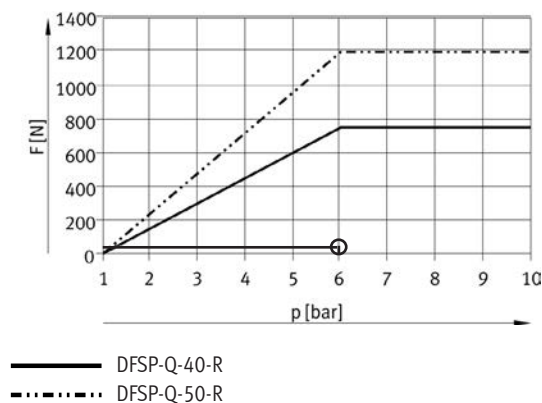

Data sheet

Selection aid

Stopping or separating several pallets

The stopper cylinder is used to separate pallets. Further pallets collide with the pallets already resting against the stopper cylinder. It is therefore vital that a buffer is mounted between the pallets (e.g. elastomer elements).

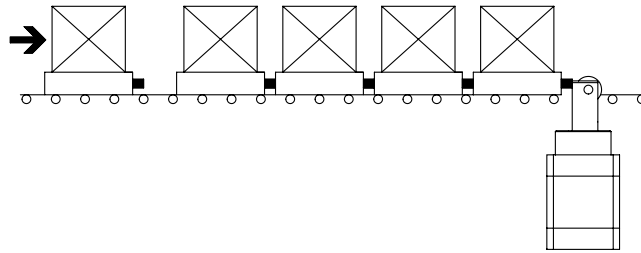

Example

Assuming:

Friction factor $\mu = 0.1$

Conveyor speed $v = 15 \text{ m/min}$

Pallet with workpiece $m = 40 \text{ kg}$

Operating pressure $p = 0.6 \text{ MPa}$ (6 bar)

Maximum number of pallets accumulating simultaneously $n_{\text{group}} = 1$

Maximum number of all queued pallets $n_{\text{queue}} = 5$

Maximum number of all advancing pallets $n_{\text{queue-1}} = 4$

Spring travel of the pallet buffer $s_F = 1 \text{ mm}$

Selection: Stopper cylinders DFSP-Q-40-...-R

1. Checking the permissible load of the first pallet

The maximum permissible load at a conveyor speed of 15 m/min is 60 kg. This means that a total load of 40 kg for the pallet and the workpiece is permissible.

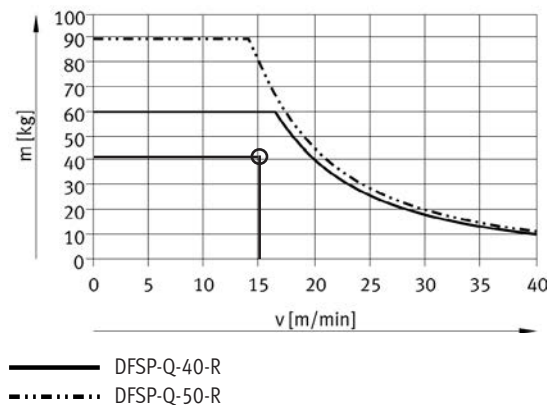

2a. Calculation of the maximum permissible impact force when pallets collide with a pallet resting against the stopper cylinder

For DFSP-Q-40-...-R, the maximum permissible impact force is 4,500 N. This means that with a total force of 2700 N, the number of pallets is permissible.

Impact force calculation:

$$F_{\text{Stoß}} = \frac{(n_{\text{Gruppe}} \cdot m) \cdot v^2}{s_F} = \frac{(1 \cdot 40 \text{ kg}) \cdot \left(15 \frac{\text{m}}{60 \text{ s}}\right)^2}{0,001 \text{ m}} = \text{ca. } 2500 \text{ N}$$

Frictional force:

$$F_{\text{Reib}} = \mu \cdot (n_{\text{Ansteh}} \cdot m) \cdot g = 0,1 \cdot (5 \cdot 40 \text{ kg}) \cdot 9,81 \frac{\text{m}}{\text{s}^2} = \text{ca. } 200 \text{ N}$$

Max. total force:

$$F_{\text{ges}} = F_{\text{Stoß}} + F_{\text{Reib}} = 2500 \text{ N} + 200 \text{ N} = 2700 \text{ N}$$

Data sheet

Selection aid

2b. Checking the permissible lateral force during the switching operation

Lateral force F_Q = frictional force $F_{friction}$
 $F_{friction} = 200 \text{ N}$

The maximum permissible lateral force at an operating pressure of 6 bar is 750 N.

This means that the lateral force of 200 N is permissible.

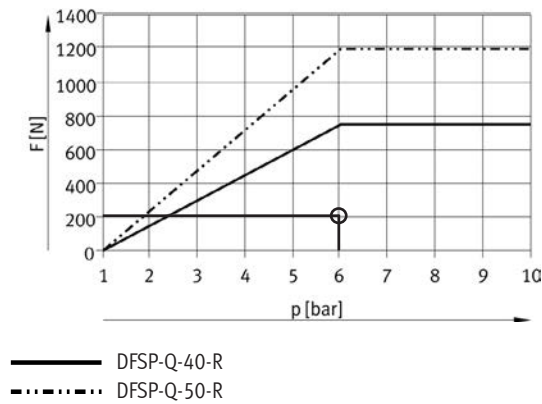

3. Separating and advancing the pallets

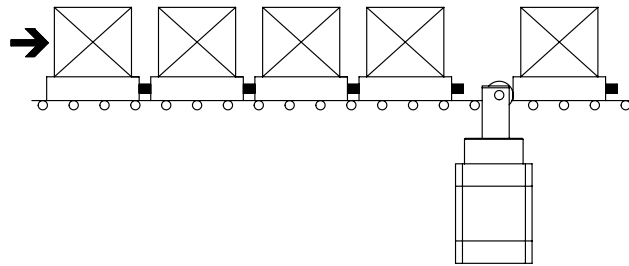

For the DFSP-Q-40-...-R, the maximum permissible load at a conveyor speed of 15 m/min is 60 kg.

The total load of the 4 pallets advancing on the stopper cylinder is 160 kg. The next largest stopper cylinder is therefore not permissible for this application as a max. of 80 kg at a speed of 15 m/min is permissible here.

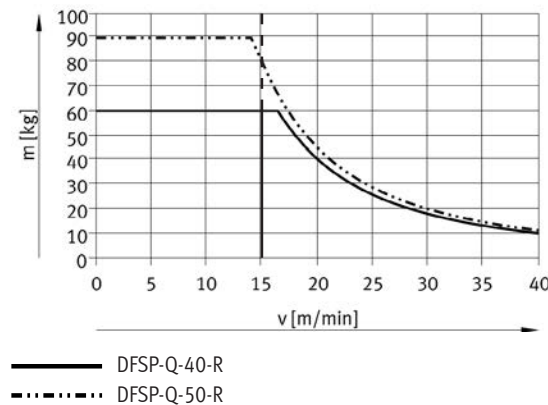

Max. total load:

$$m_{total} = n_{queue-1} \times m = 4 \times 40 \text{ kg} = 160 \text{ kg}$$

Result

When using the stopper cylinder DFSP-Q-50-...-R, max. 2 advancing pallets may accumulate simultaneously.

Max. total load:

$$m_{total} = n_{queue-1} \times m = 2 \times 40 \text{ kg} = 80 \text{ kg}$$

Festo - Your Partner in Automation



1 Festo Inc.
5300 Explorer Drive
Mississauga, ON L4W 5G4
Canada

Festo Customer Interaction Center
Tel: 1 877 463 3786
Fax: 1 877 393 3786
Email: customer.service.ca@festo.com

2 Festo Pneumatic
Av. Ceylán 3,
Col. Tequesquináhuac
54020 Tlalnepantla,
Estado de México

Multinational Contact Center
01 800 337 8669
ventas.mexico@festo.com

3 Festo Corporation
1377 Motor Parkway
Suite 310
Islandia, NY 11749

Festo Customer Interaction Center
1 800 993 3786
1 800 963 3786
customer.service.us@festo.com

4 Regional Service Center
7777 Columbia Road
Mason, OH 45040

Connect with us



www.festo.com/socialmedia



www.festo.com

Subject to change