

Round cylinder CRHD

FESTO



Characteristics

At a glance

Further information → [crhd](#)

Features of stainless-steel cylinders:

Their applications:

- Even in harsh operating environments, components have to be sturdy and totally reliable. The aim is to achieve high availability while reducing downtimes in machine systems. Wherever pneumatic drives stand no chance because their surface quality cannot withstand the surrounding media, stainless steel cylinders are the best choice. The corrosion-proof design of systems requires not only the selection of a suitable steel, but also a matching range of mounting components and accessories.
- Application example: In the maturing cellar of a cheese factory, stainless-steel cylinders are surrounded by an atmosphere with an unpleasant mix of ammonia, lactic acid and 98% humidity.

Our strength:

- Stainless-steel cylinders from Festo are characterised by resistant materials, such as 1.4301 and 1.4401. These popular high-alloy, stainless austenitic chrome-nickel and chrome-nickel-molybdenum steels protect against chemical or electrochemical stress as well as damage to the material surfaces caused by cleaning agents and disinfectants. These material groups are particularly resistant to even surface corrosion and offer increased protection against pitting and crevice corrosion.

The benefit to you:

- Our stainless steel cylinders are globally available thanks to the worldwide Festo service network. We offer an extensive range of standards-based cylinders to DIN ISO 15552 and 6432. In addition, we supply a range of mounting components and accessories tailored to the cylinders. The stainless steel cylinders are provided with NSF-H1 compliant greases and with wipers according to BGVV (Federal Institute for Risk Assessment) guidelines. They can thus be used in the food sector. We would be happy to inform you about future additions to our stainless-steel program. Take advantage of this opportunity and get in touch with us!

Good to know:

- For difficult applications, you can rely on our years of experience in stainless steel. Our experts will answer any questions you might have about surface finishes and chemical resistance.

Resistant to:

- Absolute resistance to pitting and crevice corrosion is not always guaranteed, even with ideal application parameters. Parameters such as a concentration of chloride ions, contact time, temperature and decreasing pH value increase the pitting effect of chloride ions. It must be therefore be ensured that, during design, assembly and operation, all areas of the system can be well flushed to avoid a concentration of chloride ions.
- Selected sealing materials ensure very high resistance to numerous chemical compounds. Further information on media resistance can be found on the Internet at www.festo.com.
- In many industry sectors, machinery gets exposed to different kinds of contamination and therefore needs to be cleaned. The extent of the cleaning process ranges from dry wiping of the system to wet cleaning and foam cleaning with different application times and concentrations. A general recommendation on compatibility is therefore not possible. In principle, we recommend cleaning with the piston rod retracted to avoid washing out the lifetime lubrication.

Diagrams

Further information → [crhd](#)



The diagrams shown in this document are also available online. These can be used to display precise values.

Characteristics

Cushioning

End-position cushioning has the following functions:

- Reduces kinetic energy in the end positions
- Avoids vibrations
- Reduces noise generation

[PPV] Pneumatic cushioning, adjustable at both ends

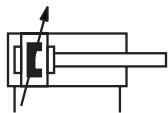

The drive is fitted with pneumatic end-position cushioning, which can be adapted by the operator for maximum performance according to the moving mass and speed.

Benefits:

- Very powerful

Position sensing

[A] For proximity sensor

By using proximity switches, any position can be detected.

Type of end cap

[MQ] Without mounting threads

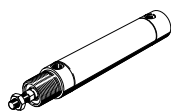

[MC] With clevis

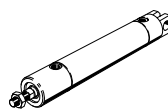

[MS] With strap

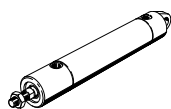

Temperature range

[S6] Heat-resistant seals max. 120 °C



For use in the temperature range $-20 \dots +120 \text{ }^{\circ}\text{C}$

Type code

001	Series	
CRHD	Round cylinder, double-acting, stainless steel	

002	Piston diameter [mm]	
32	32	
40	40	
50	50	
63	63	
80	80	
100	100	

003	Stroke range [mm]	
...	10 ... 500	

004	Cushioning	
PPV	Pneumatic cushioning, adjustable at both ends	

005	Position sensing	
A	For proximity sensor	

006	Type of end cap	
MC	With clevis	
MS	With strap	
MQ	Without mounting threads	

007	Temperature range	
	Standard	
S6	Heat-resistant seals max. 120 °C	

Datasheet

General technical data

Piston diameter	32 mm	40 mm	50 mm	63 mm	80 mm	100 mm
Stroke	10 ... 500 mm					
Pneumatic connection	G1/8		G1/4	G3/8		
Piston rod thread type ¹⁾	Male thread					
Design	Piston Piston rod					
Cushioning	Pneumatic cushioning, adjustable at both ends					
Cushioning length	17 mm	19.5 mm	21 mm	31 mm		
Position detection	Via proximity switch					
Mounting position	optional					

1) Piston rod thread:

- Ø 32: M10x1.25
- Ø 40: M12x1.25
- Ø 50, 63: M16x1.5
- Ø 80, 100: M20x1.5

Operating and environmental conditions

Temperature range	Standard	Heat-resistant seals max. 120°C
Operating medium	Compressed air to ISO 8573-1:2010 [7:4:4]	
Note on operating and pilot medium	Lubricated operation possible (in which case lubricated operation will always be required)	
Operating pressure	1 ... 10 bar	
Ambient temperature ¹⁾	-20 ... 80°C	-20 ... 120°C
Suitable for use with food ²⁾	See supplementary material information	
Corrosion resistance class CRC ³⁾	3 - high corrosion stress	3 - High corrosion stress, 3 - high corrosion stress

1) Note the operating range of the proximity switches.

2) CRHD...S6: Not suitable for direct contact with food products because of the seals and the grease used.

More information www.festo.com/sp/Certificates

3) Outdoor exposure under moderate corrosive conditions. External visible parts with primarily functional surface requirements that are in direct contact with the surrounding industrial environment.

More information: www.festo.com/x/topic/crc

Forces

Piston diameter	32 mm	40 mm	50 mm	63 mm	80 mm	100 mm
Theoretical force at 0.6 MPa (6 bar, 87 psi), advance stroke	483 N	754 N	1,178 N	1,870 N	3,016 N	4,712 N
Theoretical force at 0.6 MPa (6 bar, 87 psi), return stroke	415 N	633 N	990 N	1,682 N	2,721 N	4,418 N

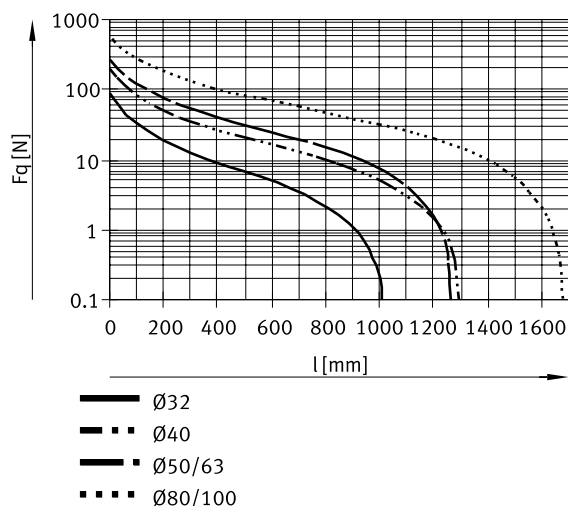
Permissible lateral force F_q as a function of stroke length l – horizontal mounting

Datasheet

Permissible lateral force F_q as a function of stroke length l – vertical mounting

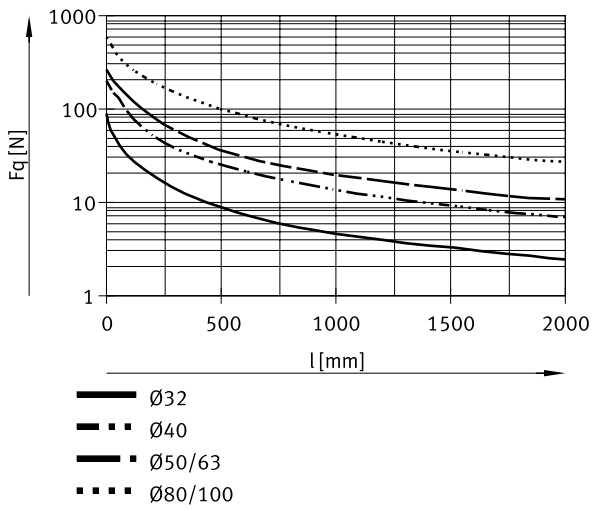

Weight						
Piston diameter	32 mm	40 mm	50 mm	63 mm	80 mm	100 mm
Basic weight for 0 mm stroke	640 g	1,154 g	1,792 g	2,912 g	5,072 g	8,357 g
Additional weight per 10 mm stroke	26 g	42 g	57 g	65 g	100 g	115 g
Moving mass for 0 mm stroke	106 g	198 g	340 g	398 g	717 g	968 g
Additional moving mass per 10 mm stroke	9 g	16 g	25 g		38 g	

Materials	
Temperature range	Standard Heat-resistant seals max. 120°C
Material housing	High-alloy stainless steel
Material cover	High-alloy stainless steel
Material piston rod	High-alloy stainless steel
Material seals	NBR TPE-U(PU) FPM
LABS (PWS) conformity	VDMA24364-B2-L

Dimensions

Dimensions – CRHD-...-MQ – Bearing cap with male thread

Download CAD data → www.festo.com

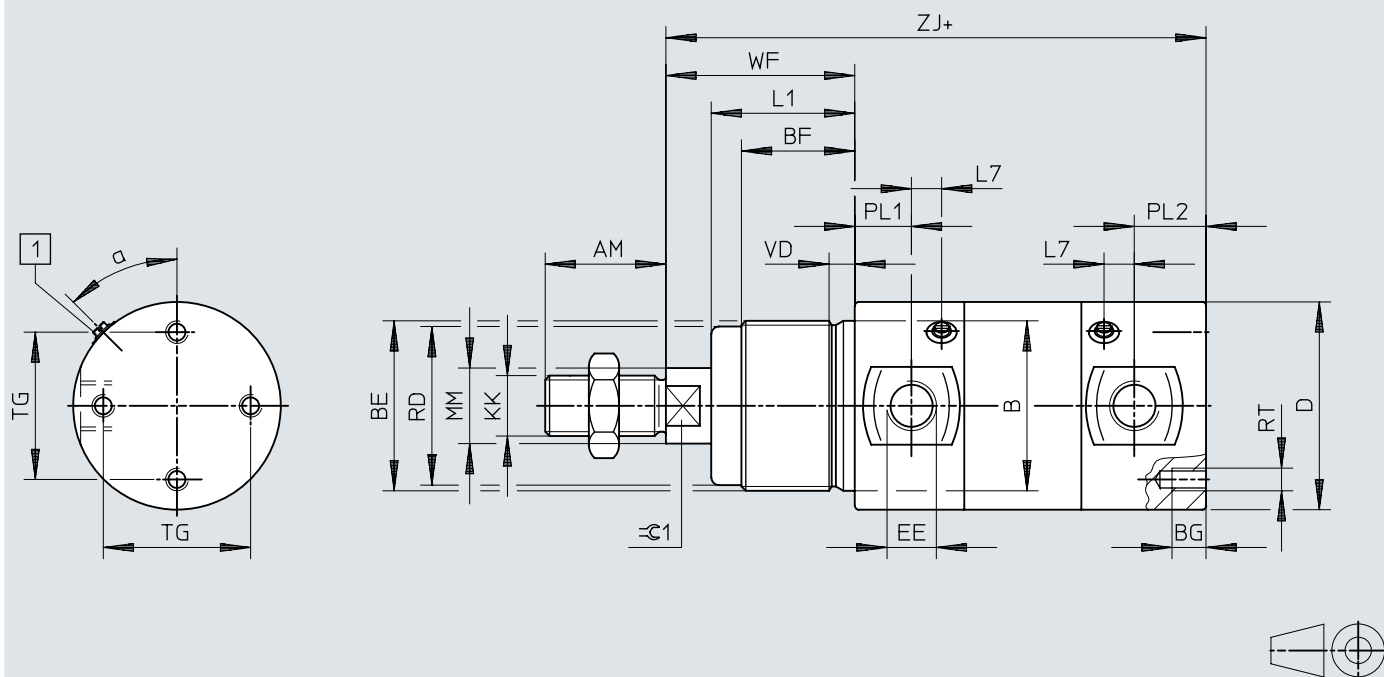

[1] Adjusting screw for end-position cushioning

[2] + = plus stroke length

	α	AM	B ø h9	BE	BF	BG	D ø	EE	KK	L1
CRHD-32	50°	22	30	M30x1,5	25	8	36	G1/8	M10x1,25	30
CRHD-40	45°	24	38	M38x1,5	29	8	45	G1/8	M12x1,25	35
CRHD-50	45°	32	45	M45x1,5	30	8	55	G1/4	M16x1,5	38
CRHD-63	45°	32	45	M45x1,5	30	10	68	G3/8	M16x1,5	38
CRHD-80	45°	40	50	M50x2	30	15	86	G3/8	M20x1,5	38
CRHD-100	45°	40	50	M50x2	30	15	106	G3/8	M20x1,5	38

	L7	MM ø	RD ø	RT	PL1	PL2	TG	VD	WF	ZJ	⊖ε1
CRHD-32	5	12	27	M5	13	21	22	7	38	120	10
CRHD-40	8	16	35	M6	15	18	30	7	45	135	13
CRHD-50	5	20	42	M6	15	19	39	6,25	50	143	17
CRHD-63	8	20	42	M8	17	24	49	6,25	50	158	17
CRHD-80	9	25	47	M10	18	31	65	7,5	50	174	22
CRHD-100	13	25	47	M10	22	30	82	7,5	50	189	22

Dimensions

Dimensions – CRHD-...-MC – End cap with clevis

Download CAD data → www.festo.com

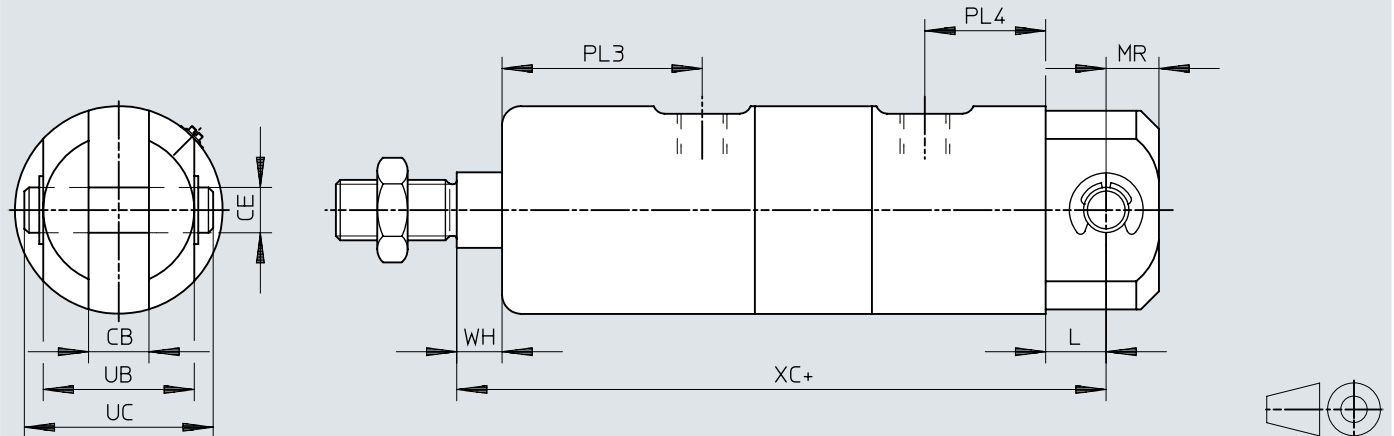

[1] += plus stroke length

	CB +0,2/+0,1	CE ∅ e8	L	MR	PL3	PL4	UB -0,1/-0,2	UC	WH	XC
CRHD-32	10	10	15	12	43	28	26	35	8	142
CRHD-40	12	12	16	14	50	27	32	43	10	160
CRHD-50	16	12	16	14	53	30	40	51	12	170
CRHD-63	16	16	22	18	55	34	40	53	12	190
CRHD-80	20	16	22	20	56	45	60	73	12	210
CRHD-100	20	20	27	25	60	43,5	60	73	12	230

Dimensions

Dimensions – CRHD-...-MS – End cap with lug

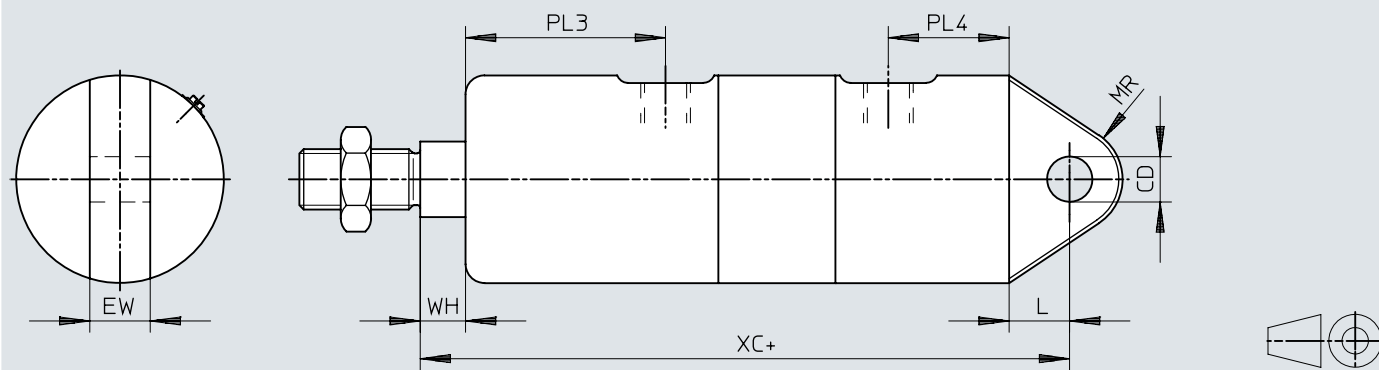
Download CAD data → www.festo.com

[1] += plus stroke length

	CD ∅ H9	EW -0,1/-0,2	L	MR	PL3	PL4	WH	XC
CRHD-32	10	10	15	12	43	28	8	142
CRHD-40	12	12	16	14	50	27	10	160
CRHD-50	12	16	16	14	53	30	12	170
CRHD-63	16	16	22	18	55	34	12	190
CRHD-80	16	20	22	20	56	45	12	210
CRHD-100	20	20	27	25	60	43,5	12	230

Dimensions

Dimensions – Clevis foot CRLMC

Download CAD data → www.festo.com

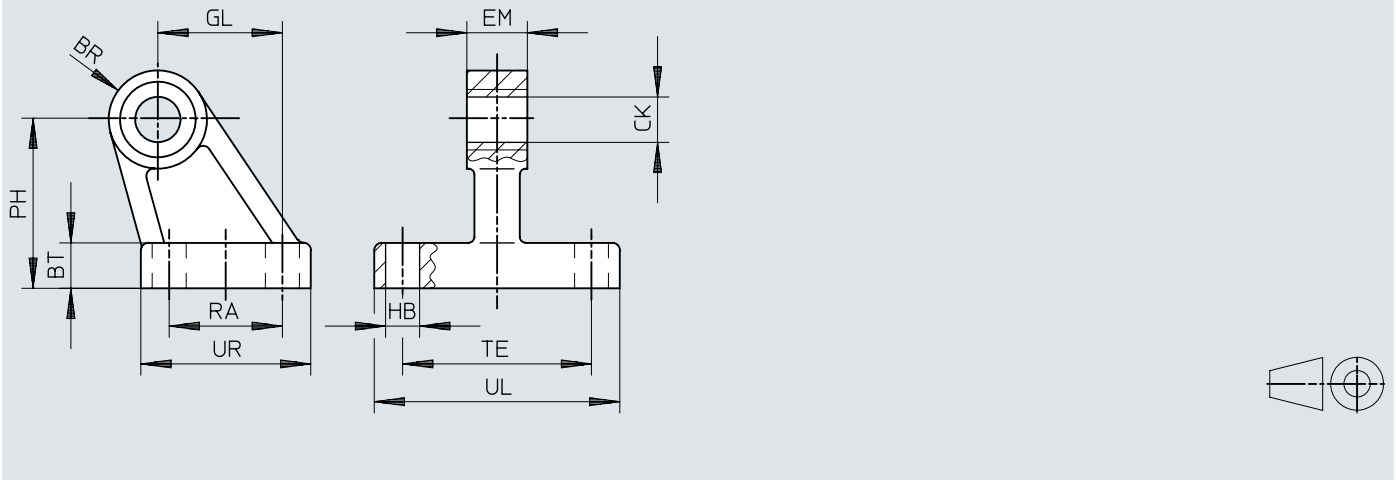

	BR	BT	CK ∅ D11	EB ∅ H13	EM	GL	HB ∅ H13	OF	PH	RA	TE	UL	UR
CRLMC-32	10	8	10	–	10	21	6,6	–	32	18	38	51	31
CRLMC-40	11	10	12	–	12	24	6,6	–	36	22	41	54	35
CRLMC-50	12	12	12	–	16	33	9	–	45	30	50	65	45
CRLMC-63	15	12	16	15	16	37	9	10,8	50	35	52	67	50
CRLMC-80	15	14	16	18	20	47	11	12,7	63	40	66	86	60
CRLMC-100	19	15	20	18	20	55	11	13,7	71	50	76	96	70

Dimensions

Dimensions – Nut CR

Download CAD data → www.festo.com

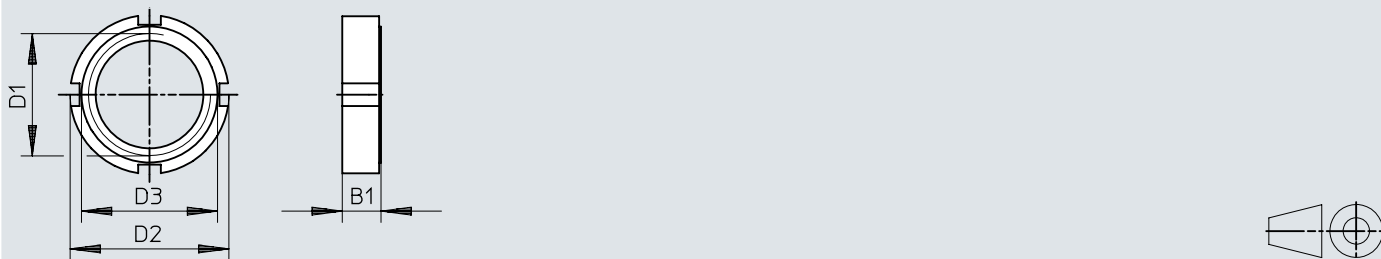

		B1	D1	D2	D3
CR-M30X1,5	32	8	M30x1,5	42	36
CR-M38X1,5	40	10	M38x1,5	50	48
CR-M45X1,5	50, 63	10	M45x1,5	60	56
CR-M50X2	80, 100	13	M50x2	75	67

Ordering data

CRHD-...-MQ – Bearing cap with male thread

	Piston diameter	Stroke	Temperature range	Part no.	Type
	32 mm	10 ... 500 mm	Standard	195507	CRHD-32- -PPV-A-MQ
			Heat-resistant seals max. 120°C	195543	CRHD-32- -PPV-A-MQ-S6
	40 mm		Standard	195508	CRHD-40- -PPV-A-MQ
			Heat-resistant seals max. 120°C	195544	CRHD-40- -PPV-A-MQ-S6
	50 mm		Standard	195509	CRHD-50- -PPV-A-MQ
			Heat-resistant seals max. 120°C	195545	CRHD-50- -PPV-A-MQ-S6
	63 mm		Standard	195510	CRHD-63- -PPV-A-MQ
			Heat-resistant seals max. 120°C	195546	CRHD-63- -PPV-A-MQ-S6
	80 mm		Standard	195511	CRHD-80- -PPV-A-MQ
			Heat-resistant seals max. 120°C	195547	CRHD-80- -PPV-A-MQ-S6
	100 mm		Standard	195512	CRHD-100- -PPV-A-MQ
			Heat-resistant seals max. 120°C	195548	CRHD-100- -PPV-A-MQ-S6

CRHD-...-MC – End cap with clevis

	Piston diameter	Stroke	Temperature range	Part no.	Type
	32 mm	10 ... 500 mm	Standard	195513	CRHD-32- -PPV-A-MC
			Heat-resistant seals max. 120°C	195549	CRHD-32- -PPV-A-MC-S6
	40 mm		Standard	195514	CRHD-40- -PPV-A-MC
			Heat-resistant seals max. 120°C	195550	CRHD-40- -PPV-A-MC-S6
	50 mm		Standard	195515	CRHD-50- -PPV-A-MC
			Heat-resistant seals max. 120°C	195551	CRHD-50- -PPV-A-MC-S6
	63 mm		Standard	195516	CRHD-63- -PPV-A-MC
			Heat-resistant seals max. 120°C	195552	CRHD-63- -PPV-A-MC-S6
	80 mm		Standard	195517	CRHD-80- -PPV-A-MC
			Heat-resistant seals max. 120°C	195553	CRHD-80- -PPV-A-MC-S6
	100 mm		Standard	195518	CRHD-100- -PPV-A-MC
			Heat-resistant seals max. 120°C	195554	CRHD-100- -PPV-A-MC-S6

CRHD-...-MS – End cap with strap

	Piston diameter	Stroke	Temperature range	Part no.	Type
	32 mm	10 ... 500 mm	Standard	195519	CRHD-32- -PPV-A-MS
			Heat-resistant seals max. 120°C	195555	CRHD-32- -PPV-A-MS-S6
	40 mm		Standard	195520	CRHD-40- -PPV-A-MS
			Heat-resistant seals max. 120°C	195556	CRHD-40- -PPV-A-MS-S6
	50 mm		Standard	195521	CRHD-50- -PPV-A-MS
			Heat-resistant seals max. 120°C	195557	CRHD-50- -PPV-A-MS-S6
	63 mm		Standard	195522	CRHD-63- -PPV-A-MS
			Heat-resistant seals max. 120°C	195558	CRHD-63- -PPV-A-MS-S6
	80 mm		Standard	195523	CRHD-80- -PPV-A-MS

Ordering data

CRHD-...-MS – End cap with strap					
	Piston diameter	Stroke	Temperature range	Part no.	Type
	80 mm	10 ... 500 mm	Heat-resistant seals max. 120°C	195559	CRHD-80- -PPV-A-MS-S6
	100 mm		Standard	195524	CRHD-100- -PPV-A-MS
			Heat-resistant seals max. 120°C	195560	CRHD-100- -PPV-A-MS-S6

Peripherals

Peripherals overview

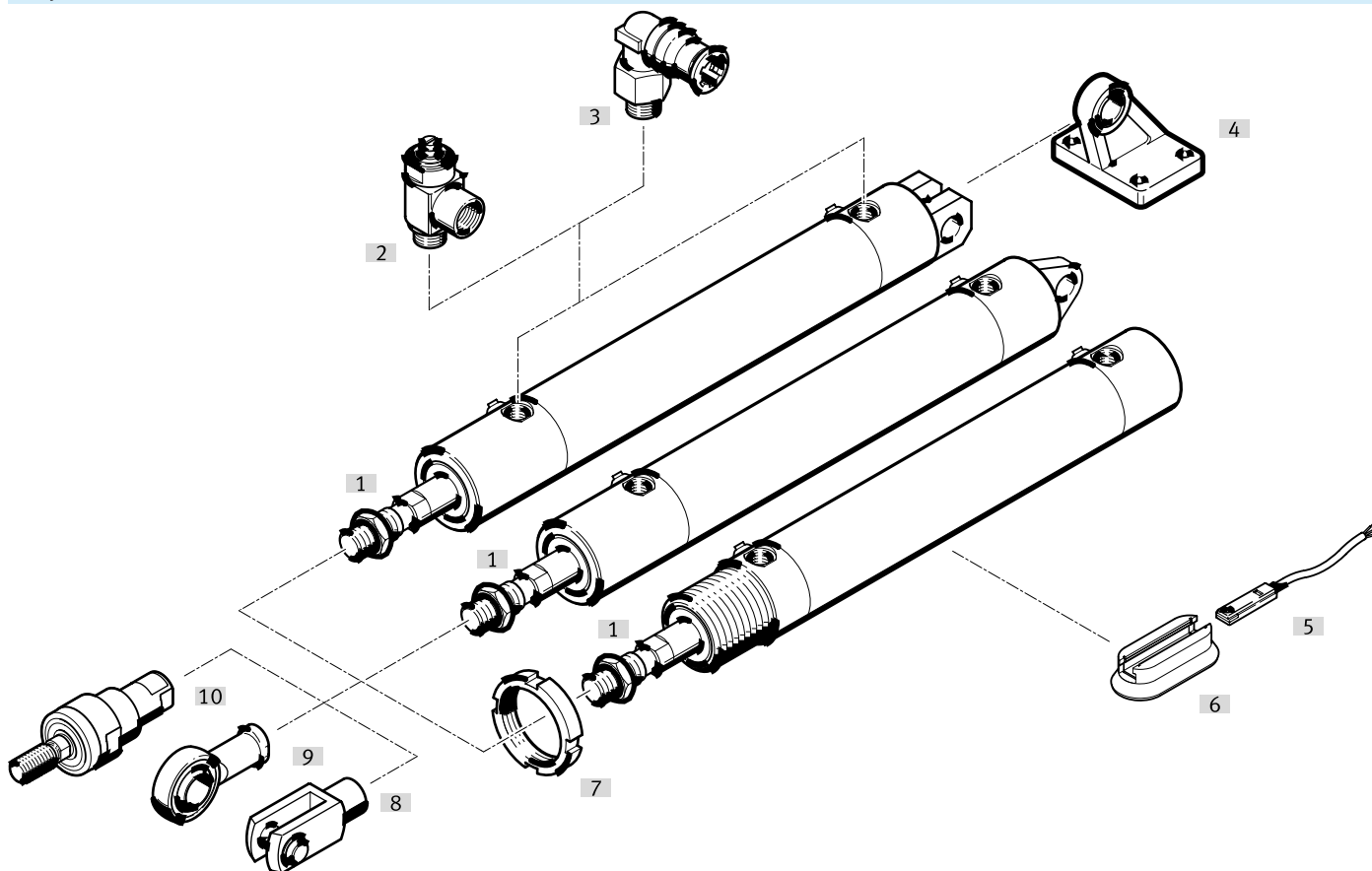

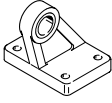

Accessories			→ Page/Internet
Type/order code	Description		
[1] Round cylinders CRHD	Double-acting, stainless steel		crhd
[2] One-way flow control valve CRGRLA	For regulating speed		15
[3] Push-in fitting CRQS	For connecting tubing with standard O.D		crqs
[4] Clevis foot CRLMC	For end cap		15
[5] Proximity switch CRSMT	With LED for switching status indication		16
[6] Mounting kit CRSMB-8-32/100	For proximity switch CRSMT		15
[7] Nut CR	For bearing cap		15
[8] Rod clevis CRSG	Permits a swivelling movement of the cylinder in one plane		15
[9] Rod eye CRSGS	With spherical bearing		15
[10] Self-aligning rod coupler CRFK	To compensate for radial and angular deviations		15

Accessories

Clevis foot CRLMC					
	Description	Material mounting	Product weight	Part no.	Type
	For Ø 32	Electropolished, High-alloy steel	112 g	197320	CRLMC-32
	For Ø 40		144 g	197321	CRLMC-40
	For Ø 50		254 g	197322	CRLMC-50
	For Ø 63		306 g	197323	CRLMC-63
	For Ø 80		482 g	197324	CRLMC-80
	For Ø 100		722 g	197325	CRLMC-100

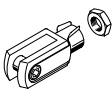
Nut CR					
	Description	Material mounting	Product weight	Part no.	Type
	For Ø 32	High-alloy stainless steel	40 g	197326	CR-M30X1,5
	For Ø 40		61 g	197327	CR-M38X1,5
	For Ø 50 ... 63		89 g	197328	CR-M45X1,5
	For Ø 80 ... 100		228 g	197329	CR-M50X2

Rod clevis CRSG					
	Description	Material rod clevis	Product weight	Part no.	Type
	for Ø 32	High-alloy steel	101.8 g	13569	CRSG-M10X1,25
	for Ø 40		162.8 g	13570	CRSG-M12X1,25
	For Ø 50 ... 63		380.2 g	13571	CRSG-M16X1,5
	For Ø 80 ... 100		757.8 g	13572	CRSG-M20X1,5

Rod eye CRSGS					
	Description	Material housing	Product weight	Part no.	Type
	for Ø 32	High-alloy steel	87 g	195582	CRSGS-M10X1,25
	for Ø 40		129 g	195583	CRSGS-M12X1,25
	For Ø 50 ... 63		265 g	195584	CRSGS-M16X1,5
	For Ø 80 ... 100		464 g	195585	CRSGS-M20X1,5

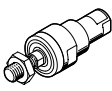
Self-aligning rod coupler CRFK					
	Description	Material housing	Product weight	Part no.	Type
	for Ø 32	High-alloy stainless steel	230 g	2305778	CRFK-M10X1,25
	for Ø 40			2305779	CRFK-M12X1,25
	For Ø 50 ... 63		670 g	2490673	CRFK-M16X1,5
	For Ø 80 ... 100		1,280 g	2545677	CRFK-M20X1,5

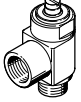
One-way flow control valves CRGRLA						
	Description	Pneumatic connection	Material swivel fitting	Product weight	Part no.	Type
	For Ø 32 ... 40	G1/8	High-alloy stainless steel	37.8 g	161404	CRGRLA-1/8-B
	For Ø 50	G1/4		71.6 g	161405	CRGRLA-1/4-B
	For Ø 63 ... 100	G3/8		126.9 g	161406	CRGRLA-3/8-B

Mounting kits CRSMB for proximity switches					
	Description	Material housing	Product weight	Part no.	Type
	For Ø 32 ... 100	Anodised aluminium, TPE-U(PU)	3 g	525565	CRSMB-8-32/100

Accessories

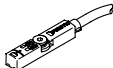
Proximity switch CRSMT-8M for T-slot, magneto-resistive						Further information → crsmt
	Type of mounting	Switching output	Electrical connection	Cable length	Part no.	Type
	Screw-clamped, Insertable in the slot from above	3-wire PNP N/O contact	Open end	5 m	574380	CRSMT-8M-PS-24V-K-5,0-OE-EX2
				10 m	574381	CRSMT-8M-PS-24V-K-10,0-OE-EX2
			Plug M8, A-coded	0.3 m	574383	CRSMT-8M-PS-24V-K-0,3-M8D-EX2
					574382	CRSMT-8M-PS-24V-K-0,3-M12-EX2

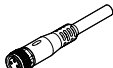
Connecting cables NEBU, straight						
	Electrical connection 1, connector system	Electrical connection 2, connector system	Electrical connection 2, number of connections/cores	Cable length	Part no.	Type
	M12x1, A-coded to EN 61076-2-101	Open end	3	2.5 m	541363	NEBU-M12G5-K-2.5-LE3
				5 m	541364	NEBU-M12G5-K-5-LE3
	M8x1, A-coded, to EN 61076-2-104			2.5 m	541333	NEBU-M8G3-K-2.5-LE3
				5 m	541334	NEBU-M8G3-K-5-LE3

Connecting cables NEBU, angled						
	Electrical connection 1, connector system	Electrical connection 2, connector system	Electrical connection 2, number of connections/cores	Cable length	Part no.	Type
	M12x1, A-coded to EN 61076-2-101	Open end	3	2.5 m	541367	NEBU-M12W5-K-2.5-LE3
				5 m	541370	NEBU-M12W5-K-5-LE3
	M8x1, A-coded, to EN 61076-2-104			2.5 m	541338	NEBU-M8W3-K-2.5-LE3
				5 m	541341	NEBU-M8W3-K-5-LE3