

Automation system CPX-AP-I

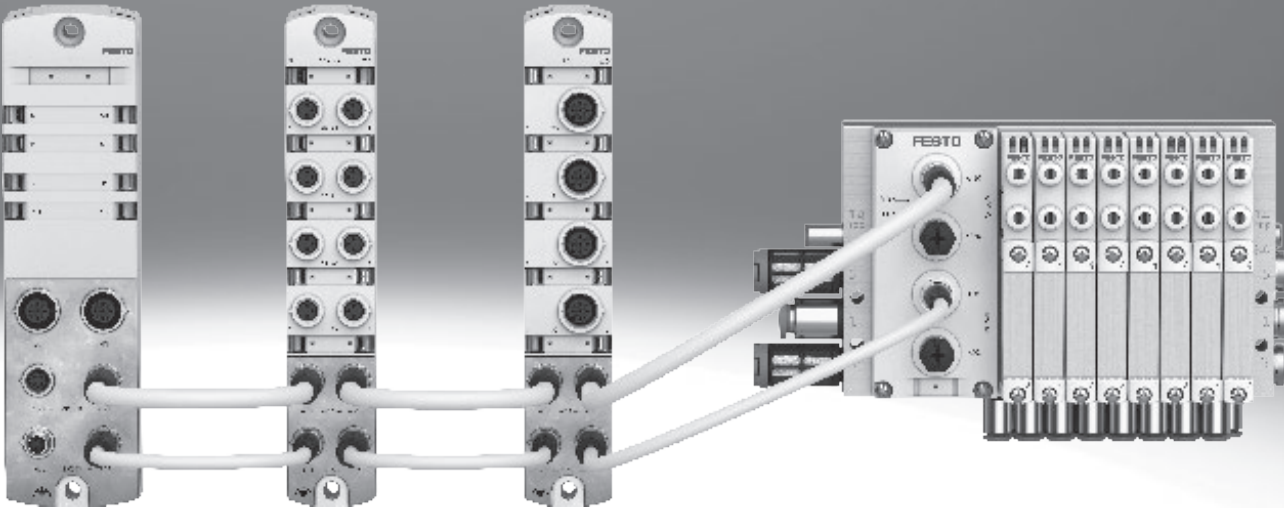

Key features

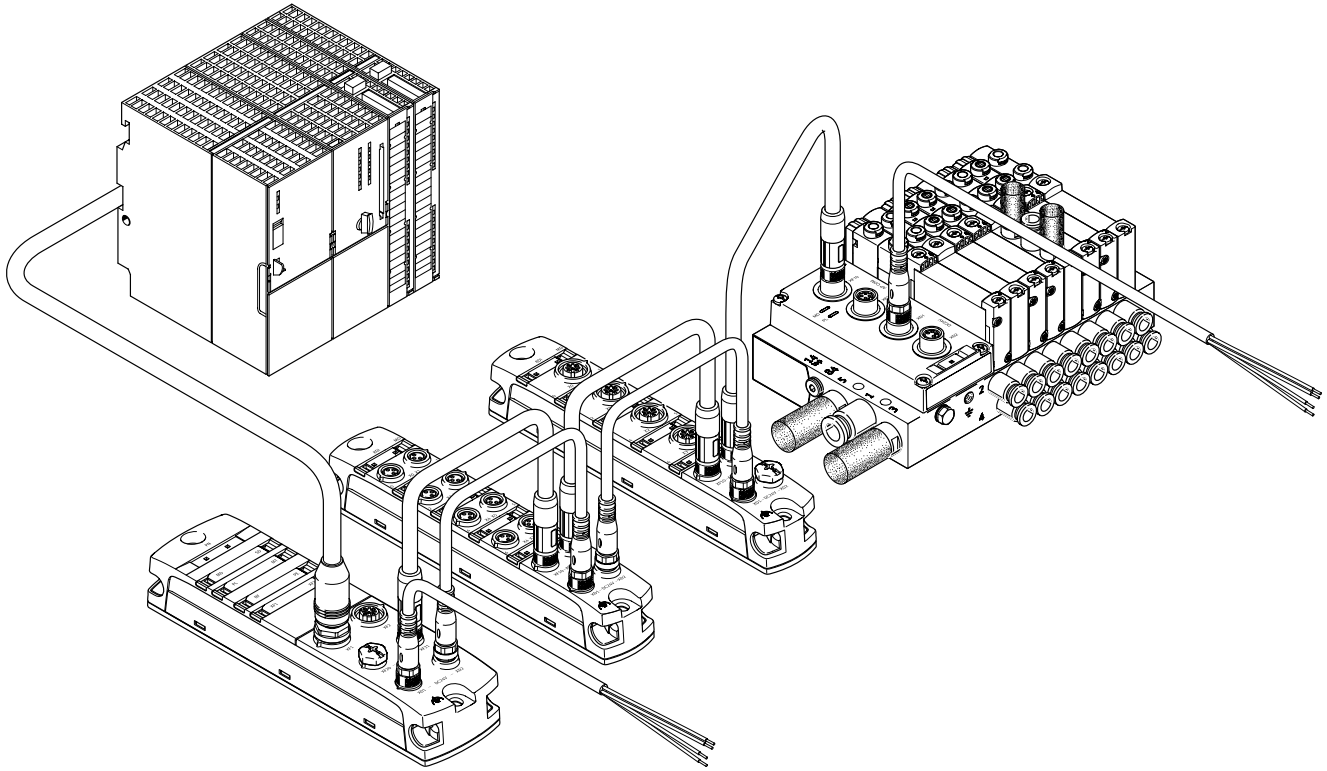

Key features

CPX-AP-I is a flexible, decentralised, compact and lightweight automation system with high degree of protection IP65/IP67.

The performance of the system is future-proof in terms of the forthcoming demands on the digital factory, and advantageous compared with a slow point-to-point connection.

The simple structure and high degree of scalability ensure the automation system CPX-AP-I is equipped for future applications:

- Extremely easy to assemble
- Separate cables for communication and power supply to form voltage zones and for stable data transfer
- Electrical isolation of output channels
- Digital electronic rating plate available
- Easy to update firmware
- Simple maintenance access to the system via Ethernet
- Easy to integrate
- Realtime capability
- Up to 80 individual modules/valve terminals per bus interface
- Easy to adapt to different control systems by exchanging the bus interface
- Direct connection of valve terminals
- Choice of M8 or M12 electrical connections
- Cable length up to 50 m cable length between the modules

An automation system CPX-AP-I consists of a bus interface and at least one other module. System communication between the modules takes place via connecting cables. The process data is exchanged cyclically.

The following module types are available:

- Bus interface
- IO-Link master
- Input modules
- Input/output modules
- Interface to the valve terminal

Key features

Overview

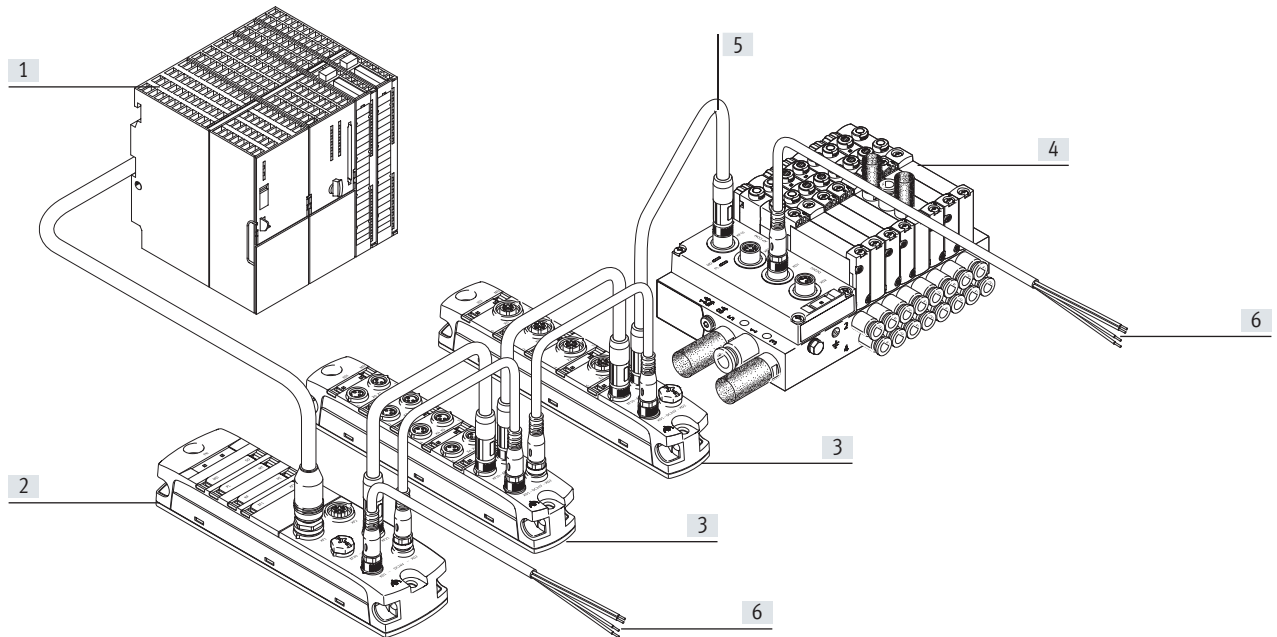



- [1] Higher-order controller
- [2] Bus interface for connecting the automation system CPX-AP-I to a higher-order controller via a standard bus protocol such as PROFINET
- [3] Input module, output module or input/output module; allows sensors and actuators to be connected to the automation system CPX-AP-I. Up to 80 modules per bus interface possible
- [4] Valve terminal with electrical interface for CPX-AP-I. Behaves like an output module within the automation system CPX-AP-I
- [5] Connecting cable for communication between the modules and the bus interface. The maximum line length from the bus interface to the module is 50 m
- [6] Connecting cable for supplying power to the components of the automation system CPX-AP-I. Each module can be connected individually or a central supply is transmitted from module to module

 **Note**

The connecting cables are specially designed for the requirements of the automation system CPX-AP-I.

If variants other than those specified in the accessories are used, the correct operation of the system cannot be guaranteed.

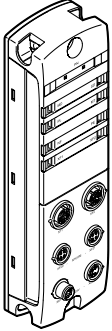
Product range overview

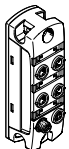
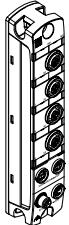
Function	Design	Type		→ Page/ Internet	
Bus interface		PROFINET	CPX-AP-I-PN-M12	<ul style="list-style-type: none"> Control via PROFINET Two PROFINET connections Two connections for system communication Two connections for power supply and transmission 	11
		PROFIBUS	CPX-AP-I-PB-M12	<ul style="list-style-type: none"> Control via PROFIBUS Two PROFIBUS connections Two connections for system communication Two connections for power supply and transmission 	17
		EtherCAT	CPX-AP-I-EC-M12	<ul style="list-style-type: none"> Control via EtherCAT Two EtherCAT connections Two connections for system communication Two connections for power supply and transmission 	23
		EtherNet/IP	CPX-AP-I-EP-M12	<ul style="list-style-type: none"> Control via EtherNet/IP Two Ethernet connections Two connections for system communication Two connections for power supply and transmission 	23
IO-Link master		4 IO-Link connections	CPX-AP-I-4IOL-M12	<ul style="list-style-type: none"> LED display Master V 1.1 Electrical connection M12x1, 5-pin 	35
Input module		4 inputs	CPX-AP-I-4DI	<ul style="list-style-type: none"> LED display PNP (positive switching) Characteristic curve of inputs according to IEC 61131-2, type 3 Electrical connection M8x1, 3-pin 	41
		8 inputs	CPX-AP-I-8DI	<ul style="list-style-type: none"> LED display PNP (positive switching) Characteristic curve of inputs according to IEC 61131-2, type 3 Electrical connection M8x1, 3-pin Electrical connection M12x1, 5-pin 	47
		4 inputs	CPX-AP-I-4AI	<ul style="list-style-type: none"> LED display Current, voltage, temperature or resistance measurement Electrical connection M12x1, 5-pin 	54

Product range overview

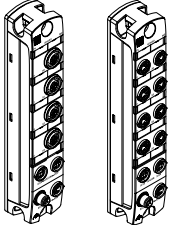
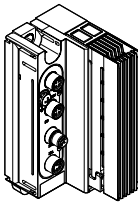
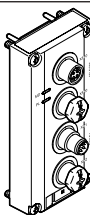
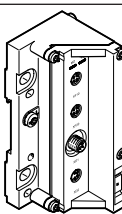
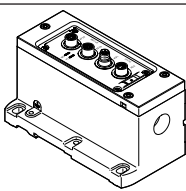
Function	Design	Type	→ Page/ Internet	
Input/output module	Digital  <ul style="list-style-type: none"> • 4 inputs • 4 outputs 	CPX-AP-I-4DI4DO	<ul style="list-style-type: none"> • LED display • PNP (positive switching) • Characteristic curve of inputs according to IEC 61131-2, type 3 • Characteristic curve outputs to IEC 61131-2, type 0.5 • Electrical connection M8x1, 3-pin • Electrical connection M12x1, 5-pin 	60
	Valve terminal VTUX  <ul style="list-style-type: none"> • Maximum of 32 valve positions • Up to 32 solenoid coils 	VABX-A-P-EL-E12-APA-SHUH	<ul style="list-style-type: none"> • LED indicator • 1 valve size (10 mm) • 2x 3/2-way valves • 5/2-way valves • 5/3-way valve • Modular design • Flow rates up to 670 l/min 	66
	Valve terminal VTUG  <ul style="list-style-type: none"> • 12 or 24 valve positions • Up to 48 solenoid coils 	VAEM-L1-S	<ul style="list-style-type: none"> • LED display • 3 valve sizes (10 mm, 14 mm and 18 mm) • 2x 3/2-way valves • 3/2-way valves • 5/2-way valves • 5/3-way valves • Fixed-grid linkage • 130 ... 1000 l/min flow rate 	72
	Valve terminal MPA-L  <ul style="list-style-type: none"> • 32 valve positions • Up to 32 solenoid coils 	VMPAL-EPL-AP	<ul style="list-style-type: none"> • LED display • 3 valve sizes (10 mm, 14 mm and 20 mm) • 2x 2/2-way valves • 2x 3/2-way valves • 3/2-way valves • 5/2-way valves • 5/3-way valves • Modular design • Flow rates of up to 870 l/min 	78
	Valve terminal VTSA  <ul style="list-style-type: none"> • 12 valve positions • Up to 24 solenoid coils 	VABA-S6-1-AP	<ul style="list-style-type: none"> • LED indicator • 4 valve sizes (18 mm, 26 mm, 42 mm and 52 mm) • 2x 2/2-way valves • 2x 3/2-way valves • 5/2-way valves • 5/3-way valves • Modular design • Flow rates of up to 2900 l/min 	vtsa

Peripherals overview

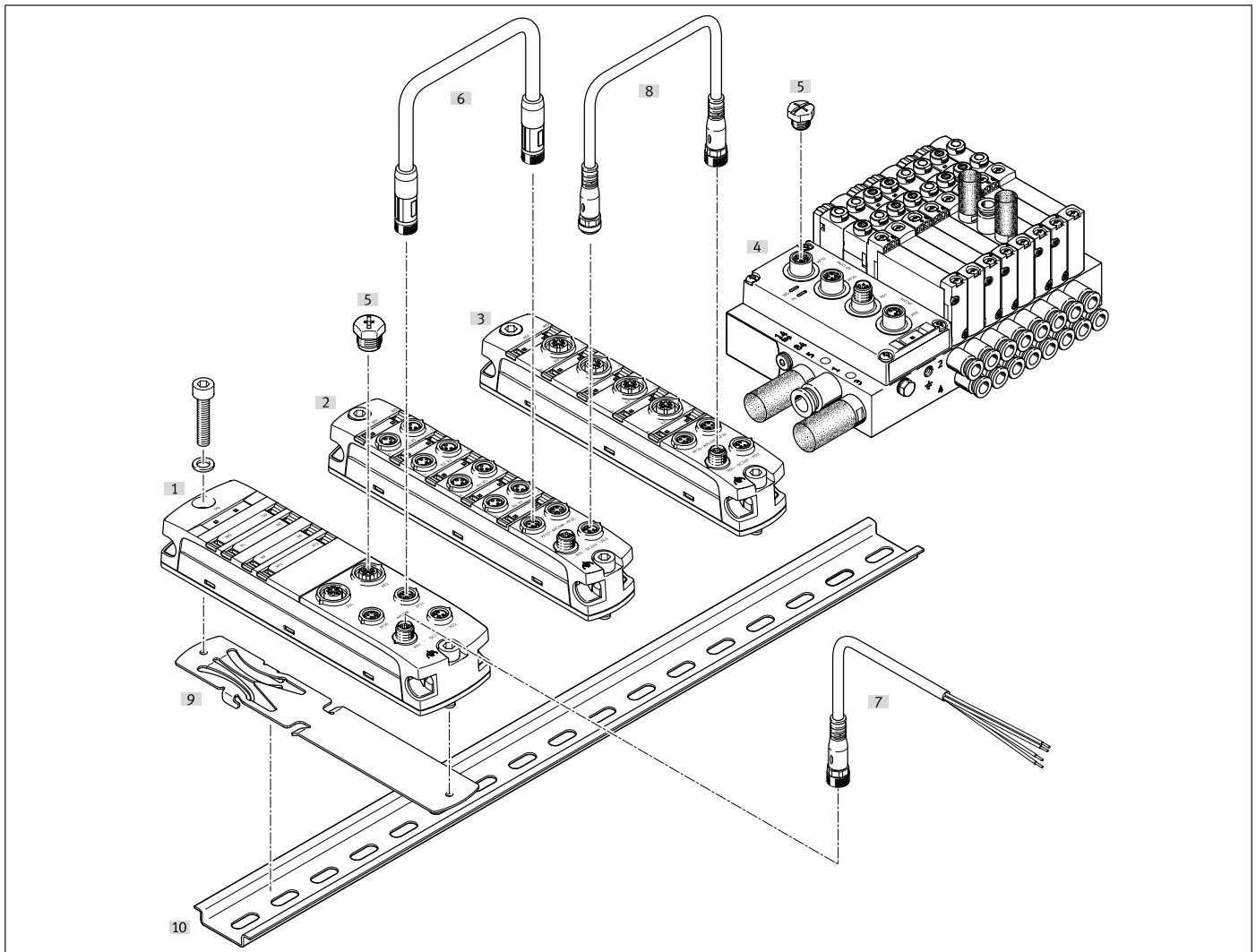

	Type	Description	→ Page/Internet
[1]	Bus interface CPX-AP-I-PN-M12 CPX-AP-I-PB-M12 CPX-AP-I-EC-M12 CPX-AP-I-EP-M12	Connection of the CPX-AP-I to a higher-order controller	11 17 23 29
[2]	Module with M8 connections CPX-AP-I-4DI-M8-3P CPX-AP-I-8DI-M8-3P CPX-AP-I-4DI4DO-M8-3P	Digital input and input/output modules	41 47 60
[3]	Module with M12 connections CPX-AP-I-4IOL-M12 CPX-AP-I-8DI-M12-5P CPX-AP-I-4AI-U-I-RTD-M12 CPX-AP-I-4DI4DO-M12-5P	IO-Link master Digital and analogue input and input/output modules	35 47 54 60
[4]	Electrical interface for valve terminal VABX-A-P-EL-E12-APA-SHUH VAEM-L1-S VMPAL-EPL-AP VABA-S6-1-AP	For valve terminal VTUX For valve terminal VTUG For valve terminal MPA-L For valve terminal VTSA	66 72 78 vtsa
[5]	Cover cap ISK-M8 ISK-M12	For sealing unused electrical connections, connection size M8 and M12	isk
[6]	Connecting cable NEBC	For connecting the modules for communication	nebc
[7]	Connecting cable NEBL	For connecting the power supply	nebl
[8]	Connecting cable NEBL	For power transmission from module to module	nebl
[9]	H-rail mounting CAFM	For mounting a module on H-rails to EN 60715	cafm
[10]	DIN mounting rail NRH-35-2000	H-rail to EN 60715	nrh

Key features – Mounting

Mounting

Wall mounting – Modules

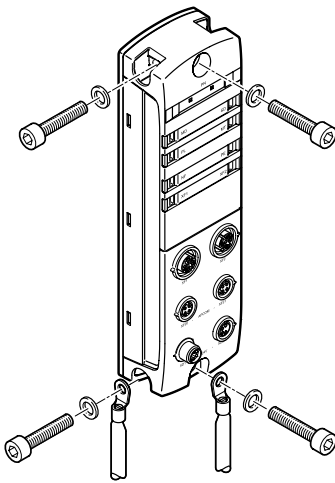

The modules can be mounted on flat surfaces in almost any position using the mounting holes provided (with screws up to 4 mm in diameter). Secure mounting requires two screws with correctly sized washers (not included in the scope of delivery).

The mounting holes also include the earthing connection for the modules.

H-rail mounting – Modules

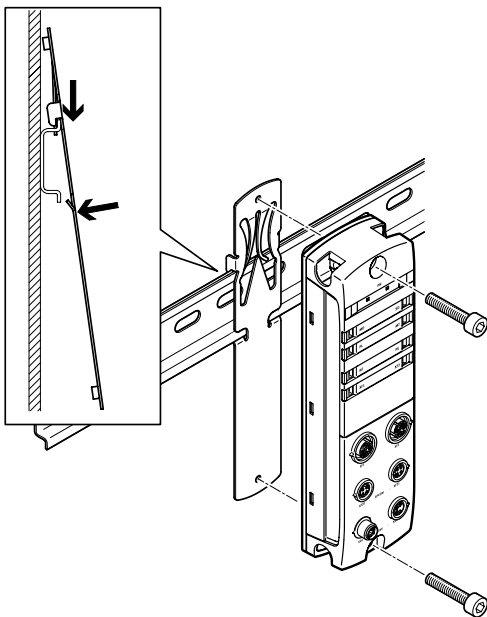

The H-rail mounting CAFM can be used to mount the modules on H-rails to EN 60715. Secure mounting requires two screws with metric thread M4 and correctly sized washers (not included in the scope of delivery).

For mounting, first the H-rail mounting is hooked onto the H-rail and latched in, and then the module is firmly screwed onto the H-rail mounting.

The mounting holes also include the earthing connection for the modules.

Assembly – Electrical interface

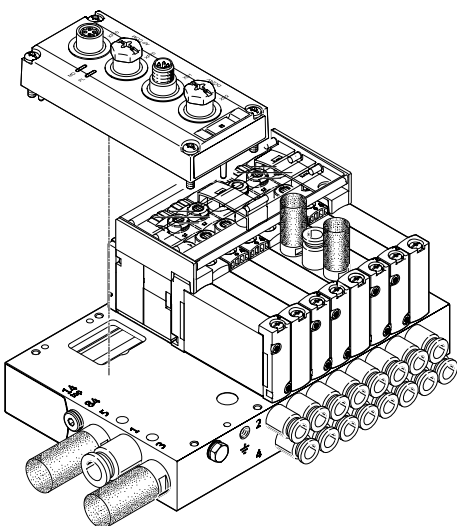

The electrical interfaces are mounted directly on the associated valve terminal.

Options for wall mounting or H-rail mounting depend on the mounting options for the valve terminal in question.

Key features – Power supply

Labelling

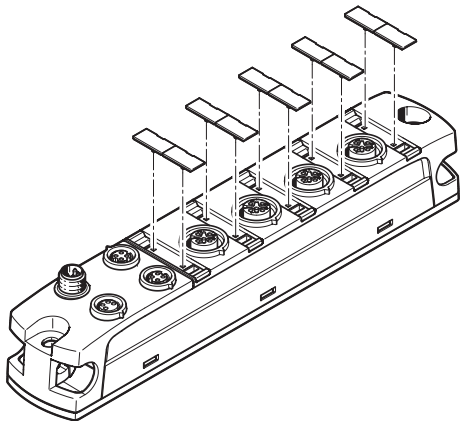

All modules are supplied with the same clip-on inscription labels. The inscription label is made up of two parts and can be divided into two smaller units if required.

Labelling templates can be downloaded from the Support Portal:
 → Internet: CPX-AP-I
 In the “Software” area.

Power supply concept

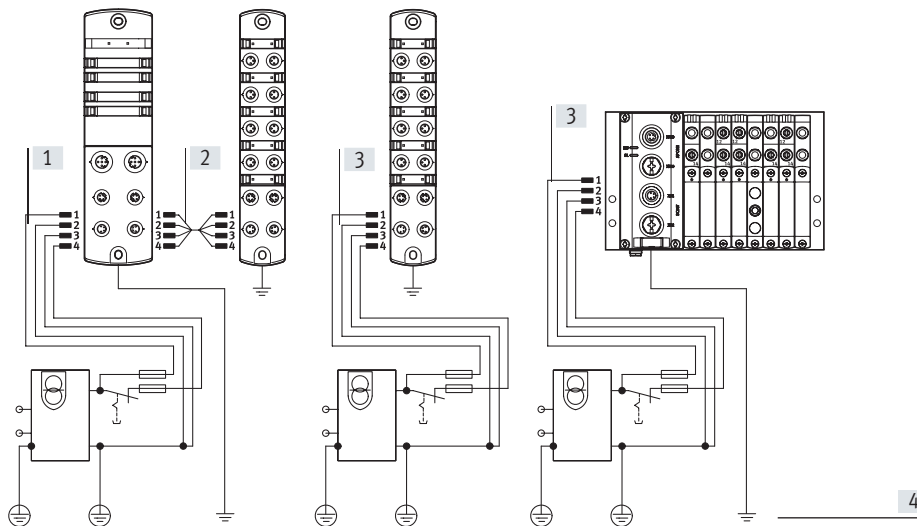

- [1] Power supply to the module via 4-pin push-in connector M8
- [2] Power transmission from module to module via 4-pin push-in connector M8
- [3] Separate power supply for an individual module
- [4] Earthing connection
- [5] Power supply for the internal electronics and sensors
- [6] Power supply for electrical outputs and valves

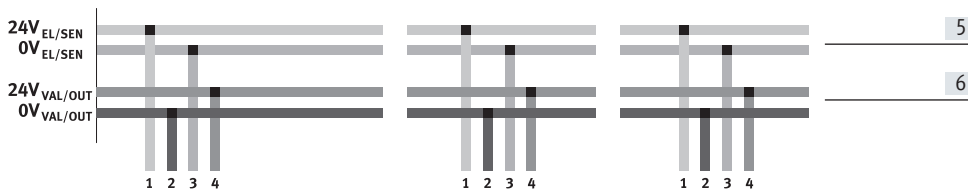

In principle, the automation system CPX-AP-I has two separate electrical circuits:

- For the module electronics and the power supply for connected sensors
- For connected outputs and valves

At the same time, the automation system allows each individual module to be separately supplied with power, or for the power supply to be transmitted from module to module.

This creates electrically isolated, all-pin disconnectable potential groups/voltage segments.

All modules have the same connections for power supply, even when a module does not require all of these itself (e.g. an input module also has connections for outputs and valves).

Key features – Diagnostics

System performance

Diagnostics

Detailed diagnostic functions are needed in order to quickly locate the causes of errors in the electrical installation and therefore reduce downtimes in the production plant.

A basic distinction is made between on-the-spot diagnostics using LEDs and diagnostics using a bus interface.

The automation system CPX-AP-I supports on-the-spot diagnostics using LED indicators on each module. This is separate from the connection area and therefore provides good visual access to status and diagnostic information.

Module and channel-specific diagnostics are supported, for example:

- Undervoltage identification
- Short circuit detection

The diagnostic messages can be read out via the bus interface in the higher-order controller and visualised so error causes can be recorded centrally and evaluated. This is done using the individual bus-specific channels.

Indicator lights

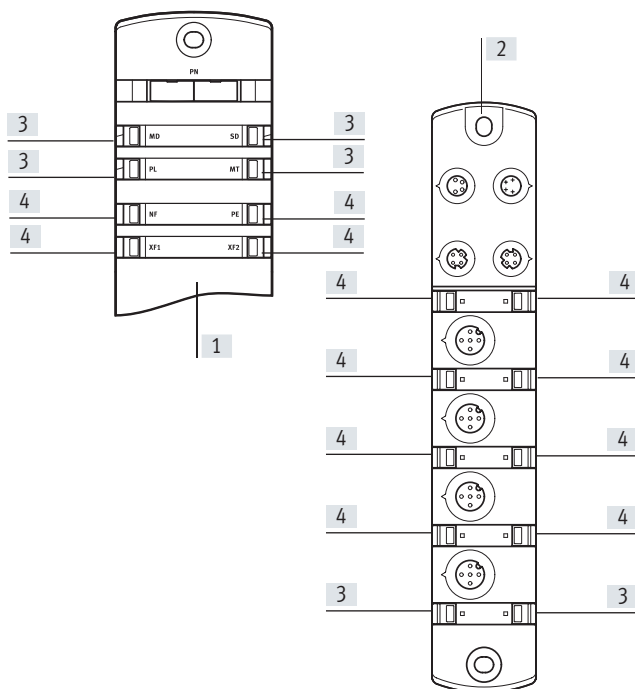

Each module has a row of LEDs for indicating the operating status of the module and of the connected sensors or actuators.

[4] Communication-specific LED indicator (e.g. status of network connection, switching status of sensor)

- [1] LED indicators on the bus interface
- [2] LED indicators on the input module, input/output module
- [3] System-specific LED indicator (e.g. power supply)

Parameterisation

Various parameters are available for reading out information about the modules of the automation system CPX-AP-I and adapting the modules to the application situation.

The parameters are typically accessed via the higher-order controller.

Key features – Addressing

Addressing

The various modules of the CPX-AP-I occupy a different number of addresses within the CPX-AP-I system. The maximum address space for the bus interface depends on the performance of the fieldbus systems.

Maximum system configuration:

- 1 bus interface
- 80 input and/or input/output modules and/or electrical interfaces

The maximum system configuration can be limited in individual cases by exceeding the address space or limitations of the higher-order controller.

Addresses are allocated automatically. The bus interface is allocated the address "1", all other modules are assigned an address in increasing value from left to right, viewed from the bus interface. The modules of the first string (XF20) come first, then the modules of the second string (XF21).



Note

Please refer to the detailed description of the configuration/addressing rules in the technical data for the CPX-AP-I bus interface.

Overview – Address space for CPX-AP-I bus interface

	Protocol	Max. total Inputs	Outputs
CPX-AP-I-PN-M12	PROFINET	1024 bytes	1024 bytes
CPX-AP-I-PB-M12	PROFIBUS	244 bytes	244 bytes
CPX-AP-I-EC-M12	EtherCAT	2048 bytes	2048 bytes
CPX-AP-I-EP-M12	EtherNet/IP	1324 bytes	1324 bytes



Note

The bandwidth of the bus interface can be restricted by the choice of module and the maximum number of modules.

Overview – Allocated addresses for CPX-AP-I modules

		Inputs [bytes]	Outputs [bytes]
CPX-AP-I-4IOL-M12	IO-Link master	12 ... 132	8 ... 128
CPX-AP-I-4DI-M8-3P	Digital input module, 4 inputs	1	–
CPX-AP-I-8DI-M8-3P	Digital input module, 8 inputs	1	–
CPX-AP-I-8DI-M12-5P	Digital input module, 8 inputs	1	–
CPX-AP-I-4AI-U-I-RTD-M12	Analogue input module, 4 inputs	8	–
CPX-AP-I-4DI4DO-M8-3P	Digital input/output module, 4 inputs/4 outputs	1	1
CPX-AP-I-4DI4DO-M12-5P	Digital input/output module, 4 inputs/4 outputs	1	1
VABX-A-P-EL-E12-APA-SHUH	Pneumatical interface to valve terminal VTUX, max. 32 valve positions	–	4
VAEM-L1-S-12-AP	Electrical interface to valve terminal VTUG, 12 valve positions	–	3
VAEM-L1-S-24-AP	Electrical interface to valve terminal VTUG, 24 valve positions	–	6
VMPAL-EPL-AP	Electrical interface to valve terminal MPA-L, 32 valve positions	–	4

Example of CPX-AP-I-PN-M12 (PROFINET)

	Inputs [bytes]	Outputs [bytes]	Remarks
26x CPX-AP-I-8DI-M8-3P	26	–	<ul style="list-style-type: none"> • The maximum number of modules is 80 CPX-AP-I modules • The available address space (1024 bytes) is not fully used up • No additional modules can be configured
45x CPX-AP-I-4DI4DO-M12-5P	45	45	
6x VAEM-L1-S-12-AP	–	18	
3x VAEM-L1-S-24-AP	–	18	
Allocated address space	71	81	

Technical data – PROFINET interface



Interface for operating the automation system CPX-AP-I on PROFINET. Data is transferred on the basis of the Ethernet standard and TCP/IP technology for communication in an industrial environment.

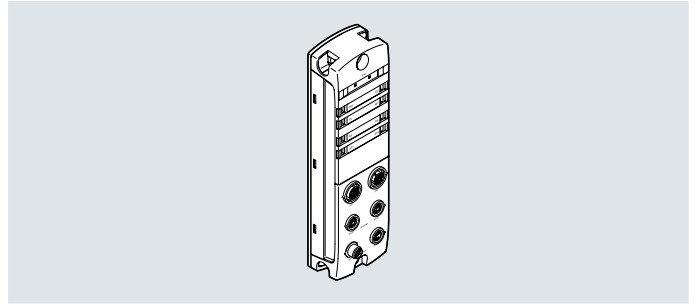

Bus connection

Communication with a higher-order controller takes place via PROFINET with real-time protocol (real time RT or isochronous real time IRT).

The bus connection is provided via two equivalent D-coded M12 sockets which meet Ethernet requirements.

The integrated switch supports star and line topology and enables the network to be divided into segments.

General technical data

Fieldbus interface		
Protocol		PROFINET IRT PROFINET RT
Function		Bus connection incoming/outgoing
Transmission rate	[Mbps]	100
Type		Ethernet
Connection type		2 x socket
Connection technology		M12x1, D-coded to EN 61076-2-101
Number of pins/wires		4
Galvanic isolation		Yes
Max. address volume for outputs	[byte]	1024
Max. address capacity inputs	[byte]	1024
Communication interface		
Protocol		AP
Function		System communication XF10 IN / XF20 OUT
Connection type		2 x socket
Connection technology		M8x1, D-coded to EN 61076-2-114
Number of pins/wires		4
Screening		Yes

Technical data – PROFINET interface

General data		
Configuration support		GSDML file
Maximum number of modules		80
Diagnostics via LED		Network error
		Diagnostics per module
		Power supply, electronics/sensors
		Power supply load
		System diagnostics
		Maintenance required
Diagnostics via bus		Load overvoltage
		Load undervoltage
		Load switch-off
		Electronics/sensors overvoltage
		Electronics/sensors undervoltage
		Logic supply undervoltage
		APDD invalid
Diagnostics via internal communication		Module error
		Short circuit/overload in sensor supply
		Short circuit/overload at output
		Undervoltage in load supply
Maximum cable length	[m]	50 system communication
Information on maximum cable length		Power supply according to nominal voltage
Reverse polarity protection		Yes

Technical data – Electrical components

Nominal operating voltage, electronics/sensors	[V DC]	24
Nominal operating voltage, load	[V DC]	24
Permissible voltage fluctuations for electronics/sensors	[%]	±25
Permissible voltage fluctuations, load	[%]	±25
Note on operating voltage		SELV/PELV power supply units required Note voltage drop
Power failure buffering	[ms]	10
Max. power supply	[A]	2x 4
		External fuse required
Intrinsic current consumption at nominal operating voltage for electronics/sensors	[mA]	Typically 80
Intrinsic current consumption at nominal operating voltage, load	[mA]	Typically 5

Electrical connection, power supply

Function		Incoming electronics/sensors and load
Connection type		Plug
Connection technology		M8x1, A-coded to EN 61076-2-104
Number of pins/wires		4

Electrical connection, power transmission

Function		Outgoing electronics/sensors and load
Connection type		Socket
Connection technology		M8x1, A-coded to EN 61076-2-104
Number of pins/wires		4

Technical data – Mechanical components

Type of mounting		Via through-hole
		On H-rail with accessories
Product weight	[g]	186
Dimensions W x L x H	[mm]	45 x 170 x 35
Tightening torque	[Nm]	1.2

Technical data – PROFINET interface

Materials		
Housing		PA
		PC
		Nickel-plated, die-cast zinc
O-ring		FPM
Note on materials		RoHS-compliant
PWIS conformity		VDMA24364-B2-L
Operating and environmental conditions		
Ambient temperature	[°C]	-20 ... +50
Storage temperature	[°C]	-40 ... +70
Corrosion resistance class CRC ¹⁾		1
Relative humidity	[%]	5 ... 95
		Non-condensing
CE marking (see declaration of conformity) ³⁾		To EU EMC Directive ²⁾
KC mark		KC EMC
UKCA marking (see declaration of conformity)		To UK instructions for EMC
Certification		RCM
		c UL us - Listed (OL)
Certificate-issuing authority		UL E239998
Degree of protection		IP65
		IP67
Note on degree of protection		Unused connections sealed

1) Additional information: www.festo.com/x/topic/kbk

2) For information about the area of use, see the EC declaration of conformity at: www.festo.com/catalogue/... → Support/Downloads.

If the devices are subject to usage restrictions in residential, commercial or light-industrial environments, further measures for the reduction of the emitted interference may be necessary.

3) Additional information: www.festo.com/catalogue/... → Support/Downloads.

Connection and display components

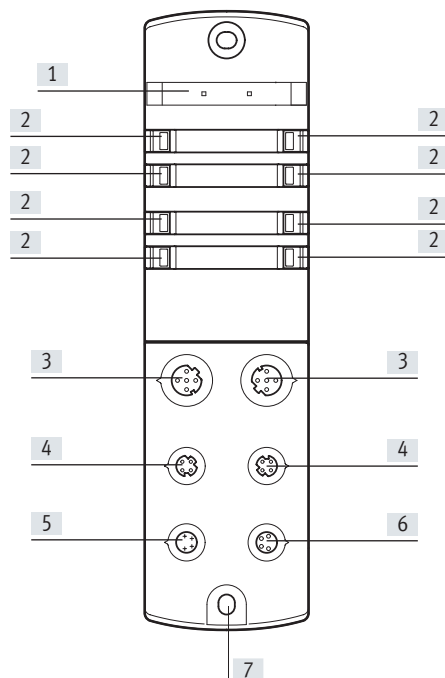

- [1] Space for inscription label
- [2] LED indicators
- [3] Network connections 1 and 2, PROFINET
- [4] Communication interface
- [5] Electrical connection, power supply
- [6] Electrical connection, power transmission
- [7] Earthing connection

Technical data – PROFINET interface

Dimensions

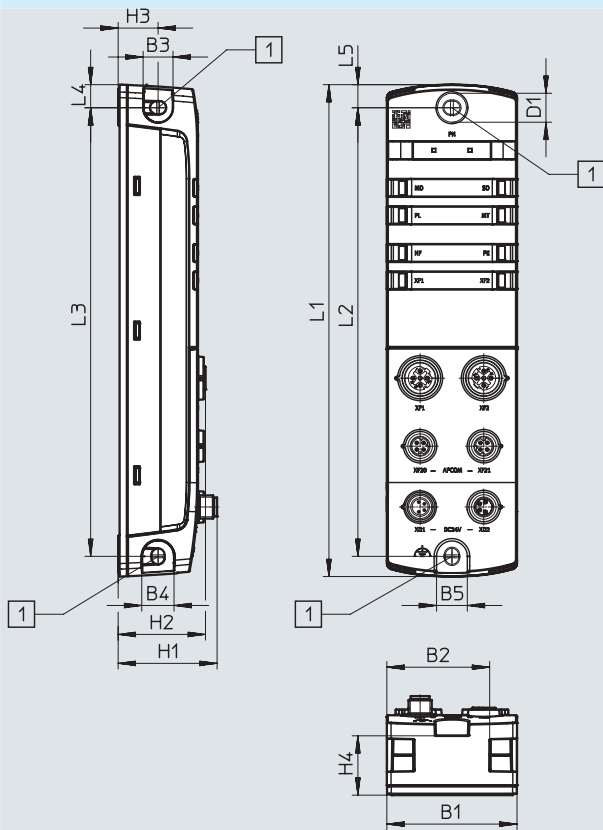

Download CAD data → www.festo.com





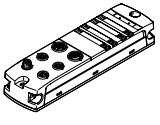

[1] Mounting hole for M4 screws

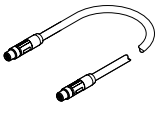
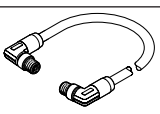
	B1	B2	B3	B4	B5	D1 ∅	H1	H2	H3	H4	L1	L2	L3	L4	L5
CPX-AP-I-PN-M12	45	35.5	10	11	11	10	34.2	30.2	13.8	20.5	170	155	155	8	8

Technical data – PROFINET interface

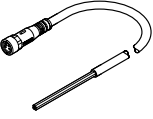
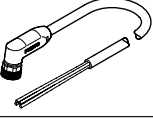
Ordering data		Part No.	Type			
	PROFINET Interface	8086607	CPX-AP-I-PN-M12			
Ordering data – Accessories						
Description		Part No.	Type			
Pre-assembled plugs						
	For bus connection	Straight plug, M12x1, 4-pin, D-coded	543109 NECU-M-S-D12G4-C2-ET			
Connecting cable						
	For communication interface	Straight plug, M8x1, 4-pin, D-coded	Straight plug, M8x1, 4-pin, D-coded	0.3 m	8082902	NEBC-D8G4-ES-0.3-N-S-D8G4-ET
				0.5 m	8065123	NEBC-D8G4-ES-0.5-N-S-D8G4-ET
				1.0 m	8065125	NEBC-D8G4-ES-1-N-S-D8G4-ET
				2.0 m	8065127	NEBC-D8G4-ES-2-N-S-D8G4-ET
				5.0 m	8065129	NEBC-D8G4-ES-5-N-S-D8G4-ET
				7.5 m	8065131	NEBC-D8G4-ES-7.5-N-S-D8G4-ET
				10.0 m	8065133	NEBC-D8G4-ES-10-N-S-D8G4-ET
				15.0 m	8065135	NEBC-D8G4-ES-15-N-S-D8G4-ET
				20.0 m	8146031	NEBC-D8G4-ES-20-N-S-D8G4-ET
				25.0 m	8146032	NEBC-D8G4-ES-25-N-S-D8G4-ET
				30.0 m	8146033	NEBC-D8G4-ES-30-N-S-D8G4-ET
40.0 m	8146034	NEBC-D8G4-ES-40-N-S-D8G4-ET				
50.0 m	8146035	NEBC-D8G4-ES-50-N-S-D8G4-ET				
	For communication interface	Angled plug, M8x1, 4-pin, D-coded	Angled plug, M8x1, 4-pin, D-coded	0.5 m	8065124	NEBC-D8W4-ES-0.5-N-S-D8W4-ET
				1.0 m	8065126	NEBC-D8W4-ES-1-N-S-D8W4-ET
				2.0 m	8065128	NEBC-D8W4-ES-2-N-S-D8W4-ET
				5.0 m	8065130	NEBC-D8W4-ES-5-N-S-D8W4-ET
				7.5 m	8065132	NEBC-D8W4-ES-7.5-N-S-D8W4-ET
				10.0 m	8065134	NEBC-D8W4-ES-10-N-S-D8W4-ET
				15.0 m	8065136	NEBC-D8W4-ES-15-N-S-D8W4-ET
				20.0 m	8146036	NEBC-D8W4-ES-20-N-S-D8W4-ET
				25.0 m	8146037	NEBC-D8W4-ES-25-N-S-D8W4-ET
				30.0 m	8146038	NEBC-D8W4-ES-30-N-S-D8W4-ET
				40.0 m	8146039	NEBC-D8W4-ES-40-N-S-D8W4-ET
50.0 m	8146040	NEBC-D8W4-ES-50-N-S-D8W4-ET				

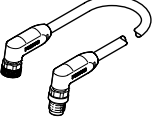
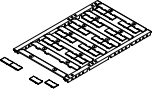
Technical data – PROFINET interface

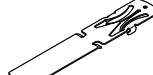
Ordering data – Accessories						
	Description				Part No.	Type
	For power supply	Straight socket, M8 x 1, 4-pin, A-coded	Open cable end, 4-wire	5.0 m	8065110	NEBL-M8G4-E-5-N-LE4
				7.5 m	8065113	NEBL-M8G4-E-7.5-N-LE4
				10.0 m	8065117	NEBL-M8G4-E-10-N-LE4
				15.0 m	8065121	NEBL-M8G4-E-15-N-LE4
		Angled socket, M8x1, 4-pin, A-coded	Open cable end, 4-wire	7.5 m	8065114	NEBL-M8W4-E-7.5-N-LE4
				10.0 m	8065118	NEBL-M8W4-E-10-N-LE4
				15.0 m	8065122	NEBL-M8W4-E-15-N-LE4
	For power transmission	Straight socket, M8 x 1, 4-pin, A-coded	Straight plug, M8 x 1, 4-pin, A-coded	0.3 m	8082904	NEBL-M8G4-E-0.3-N-M8G4
				0.5 m	8065102	NEBL-M8G4-E-0.5-N-M8G4
				1.0 m	8065104	NEBL-M8G4-E-1-N-M8G4
				2.0 m	8065106	NEBL-M8G4-E-2-N-M8G4
				5.0 m	8065108	NEBL-M8G4-E-5-N-M8G4
				7.5 m	8065111	NEBL-M8G4-E-7.5-N-M8G4
				10.0 m	8065115	NEBL-M8G4-E-10-N-M8G4
				15.0 m	8065119	NEBL-M8G4-E-15-N-M8G4
	For power transmission	Angled socket, M8x1, 4-pin, A-coded	Angled plug, M8x1, 4-pin, A-coded	0.3 m	8146577	NEBL-M8W4-E-0.3-N-M8W4
				0.5 m	8065103	NEBL-M8W4-E-0.5-N-M8W4
				1.0 m	8065105	NEBL-M8W4-E-1-N-M8W4
				2.0 m	8065107	NEBL-M8W4-E-2-N-M8W4
				5.0 m	8065109	NEBL-M8W4-E-5-N-M8W4
				7.5 m	8065112	NEBL-M8W4-E-7.5-N-M8W4
				10.0 m	8065116	NEBL-M8W4-E-10-N-M8W4
				15.0 m	8065120	NEBL-M8W4-E-15-N-M8W4
Ordering data – Accessories						
	Description			Pack size	Part No.	Type
Inscription label						
	For modules CPX-AP-I	Size 6x 12.5 mm, 10 frames with 24 pieces each		240	8087174	ASLR-L-X4-612-P240
Cover cap						
	For sealing unused connections		For connection M8x1	10	177672	ISK-M8
H-rail mounting						
	For mounting a module on H-rails to EN 60715			–	8095158	CAFM-X4-H

Technical data – PROFIBUS interface



Interface for operating the automation system CPX-AP-I in a PROFIBUS-DP network. PROFIBUS is designed for fast, time-critical and complex communications tasks and is incorporated into the international standards IEC 61158 and IEC 61784.

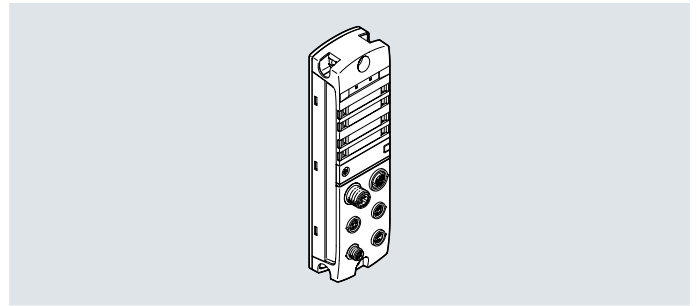

Bus connection

The bus connection is provided by two network connections PROFIBUS DP-IN (M12 plug) and PROFIBUS DP-OUT (M12 socket).

The network can be divided and enlarged using additional repeaters.

This makes it possible to structure the network and implement greater network expansions.

General technical data

Fieldbus interface						
Protocol	PROFIBUS DP-V1					
Function	Incoming bus connection					
Transmission rate	[kbps]	9.6	19.2	93.75	187.5	500
	[Mbps]	1.5	3	6	12	
Type	PROFIBUS					
Connection type	Plug					
Connection technology	M12x1, B-coded to EN 61076-2-101					
Number of pins/wires	5					
Galvanic isolation	Yes					
Fieldbus interface 2						
Protocol	PROFIBUS DP-V1					
Function	Bus connection outgoing					
Transmission rate	[kbps]	9.6	19.2	93.75	187.5	500
	[Mbps]	1.5	3	6	12	
Type	PROFIBUS					
Connection type	Socket					
Connection technology	M12x1, B-coded to EN 61076-2-101					
Number of pins/wires	5					
Galvanic isolation	Yes					
Note on fieldbus interface	Terminating resistor at socket possible					
Communication interface						
Protocol	AP					
Function	System communication XF10 IN / XF20 OUT					
Connection type	2 x socket					
Connection technology	M8x1, D-coded to EN 61076-2-114					
Number of pins/wires	4					
Screening	Yes					

Technical data – PROFIBUS interface

General data		
Configuration support		GSD file
Maximum number of modules		56
Max. address volume for outputs	[byte]	244
Max. address capacity inputs	[byte]	244
Diagnostics via LED		Buffer error LED (BF)
		Diagnostics per module
		Power supply, electronics/sensors
		Power supply load
		System diagnostics
		Maintenance required
Diagnostics via bus		Load switch-off
		Load overvoltage
		Load undervoltage
		Electronics/sensors overvoltage
		Electronics/sensors undervoltage
		APDD invalid
Maximum cable length	[m]	50 system communication
Reverse polarity protection		Yes

Technical data – Electrical components		
Nominal operating voltage, electronics/sensors	[V DC]	24
Nominal operating voltage, load	[V DC]	24
Permissible voltage fluctuations for electronics/sensors	[%]	±25
Permissible voltage fluctuations, load	[%]	±25
Note on operating voltage		SELV/PELV power supply units required
		Note voltage drop
Power failure buffering	[ms]	10
Max. power supply	[A]	2x 4
		External fuse required
Intrinsic current consumption at nominal operating voltage for electronics/sensors	[mA]	Typically 80
Intrinsic current consumption at nominal operating voltage, load	[mA]	Typically 5
Electrical connection, power supply		
Function		Incoming electronics/sensors and load
Connection type		Plug
Connection technology		M8x1, A-coded to EN 61076-2-104
Number of pins/wires		4
Electrical connection, power transmission		
Function		Outgoing electronics/sensors and load
Connection type		Socket
Connection technology		M8x1, A-coded to EN 61076-2-104
Number of pins/wires		4

Technical data – Mechanical components		
Type of mounting		Via through-hole
		On H-rail with accessories
Product weight	[g]	186
Dimensions W x L x H	[mm]	45 x 170 x 35

Materials		
Housing		PA
		PC
		Nickel-plated, die-cast zinc
O-ring		FPM
Note on materials		RoHS-compliant
PWIS conformity		VDMA24364-B2-L

Technical data – PROFIBUS interface

Operating and environmental conditions		
Ambient temperature	[°C]	-20 ... +50
Storage temperature	[°C]	-40 ... +70
Corrosion resistance class CRC ¹⁾		1
Relative humidity	[%]	5 ... 95
		Non-condensing
CE marking (see declaration of conformity) ³⁾		To EU EMC Directive ²⁾
KC mark		KC EMC
UKCA marking (see declaration of conformity)		To UK instructions for EMC
Certification		RCM
		c UL us - Listed (OL)
Certificate-issuing authority		UL E239998
Degree of protection		IP65
		IP67
Note on degree of protection		Unused connections sealed

1) Additional information: www.festo.com/x/topic/kbk

2) For information about the area of use, see the EC declaration of conformity at: www.festo.com/catalogue/... → Support/Downloads.

If the devices are subject to usage restrictions in residential, commercial or light-industrial environments, further measures for the reduction of the emitted interference may be necessary.

3) Additional information: www.festo.com/catalogue/... → Support/Downloads.

Connection and display components

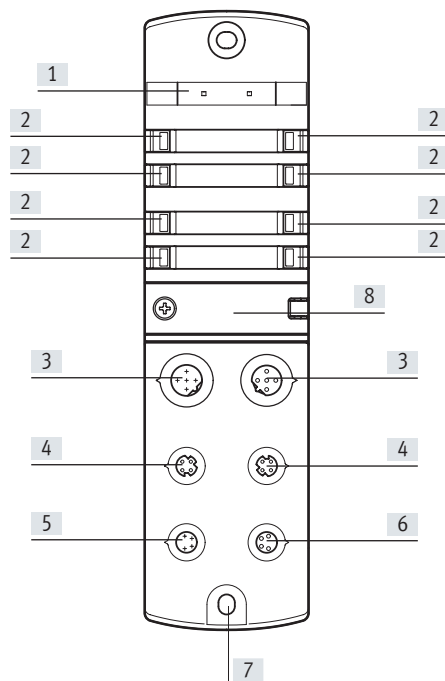

- [1] Space for inscription label
- [2] LED indicators
- [3] Network connections 1 and 2, PROFINET
- [4] Communication interface
- [5] Electrical connection, power supply
- [6] Electrical connection, power transmission
- [7] Earthing connection
- [8] DIL switch

Technical data – PROFIBUS interface

Dimensions

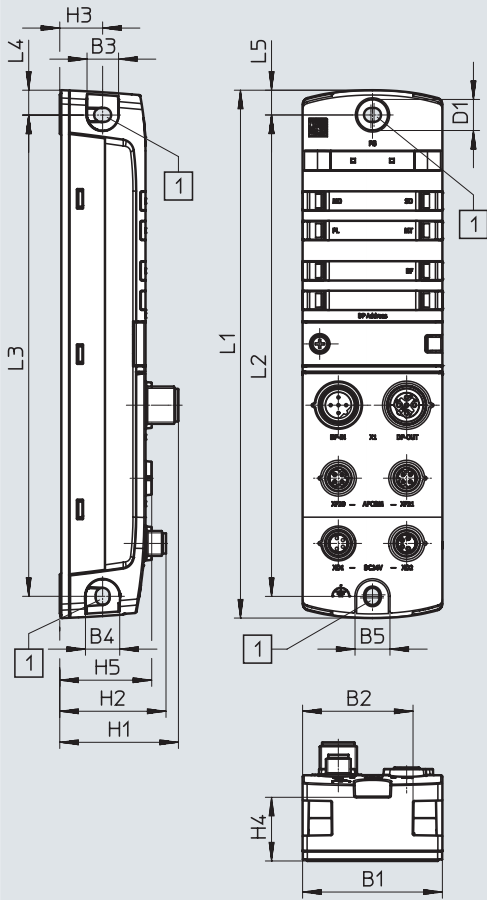

Download CAD data → www.festo.com



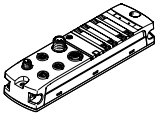

[1] Mounting hole for M4 screws

	B1	B2	B3	B4	B5	D1 ∅	H1	H2	H3	H4	H5	L1	L2	L3	L4	L5
CPX-AP-I-PB-M12	45	35.5	10	11	11	10	38.2	34.2	13.8	20.5	29.6	170	155	155	8	8

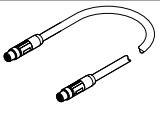
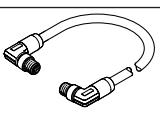
Technical data – PROFIBUS interface

Ordering data		Part No.	Type			
	PROFIBUS interface	8086608	CPX-AP-I-PB-M12			
Ordering data – Accessories						
Description		Part No.	Type			
Pre-assembled plugs						
	For bus connection	Straight socket, M12x1, 5-pin, B-coded	1067905 NECU-M-B12G5-C2-PB			
		Straight plug, M12x1, 5-pin, B-coded	1066354 NECU-M-S-B12G5-C2-PB			
Connecting cable						
	For communication interface	Straight plug, M8x1, 4-pin, D-coded	Straight plug, M8x1, 4-pin, D-coded	0.3 m	8082902	NEBC-D8G4-ES-0.3-N-S-D8G4-ET
				0.5 m	8065123	NEBC-D8G4-ES-0.5-N-S-D8G4-ET
				1.0 m	8065125	NEBC-D8G4-ES-1-N-S-D8G4-ET
				2.0 m	8065127	NEBC-D8G4-ES-2-N-S-D8G4-ET
				5.0 m	8065129	NEBC-D8G4-ES-5-N-S-D8G4-ET
				7.5 m	8065131	NEBC-D8G4-ES-7.5-N-S-D8G4-ET
				10.0 m	8065133	NEBC-D8G4-ES-10-N-S-D8G4-ET
				15.0 m	8065135	NEBC-D8G4-ES-15-N-S-D8G4-ET
				20.0 m	8146031	NEBC-D8G4-ES-20-N-S-D8G4-ET
				25.0 m	8146032	NEBC-D8G4-ES-25-N-S-D8G4-ET
				30.0 m	8146033	NEBC-D8G4-ES-30-N-S-D8G4-ET
				40.0 m	8146034	NEBC-D8G4-ES-40-N-S-D8G4-ET
				50.0 m	8146035	NEBC-D8G4-ES-50-N-S-D8G4-ET
	For communication interface	Angled plug, M8x1, 4-pin, D-coded	Angled plug, M8x1, 4-pin, D-coded	0.5 m	8065124	NEBC-D8W4-ES-0.5-N-S-D8W4-ET
				1.0 m	8065126	NEBC-D8W4-ES-1-N-S-D8W4-ET
				2.0 m	8065128	NEBC-D8W4-ES-2-N-S-D8W4-ET
				5.0 m	8065130	NEBC-D8W4-ES-5-N-S-D8W4-ET
				7.5 m	8065132	NEBC-D8W4-ES-7.5-N-S-D8W4-ET
				10.0 m	8065134	NEBC-D8W4-ES-10-N-S-D8W4-ET
				15.0 m	8065136	NEBC-D8W4-ES-15-N-S-D8W4-ET
				20.0 m	8146036	NEBC-D8W4-ES-20-N-S-D8W4-ET
				25.0 m	8146037	NEBC-D8W4-ES-25-N-S-D8W4-ET
				30.0 m	8146038	NEBC-D8W4-ES-30-N-S-D8W4-ET
				40.0 m	8146039	NEBC-D8W4-ES-40-N-S-D8W4-ET
				50.0 m	8146040	NEBC-D8W4-ES-50-N-S-D8W4-ET

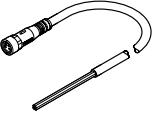
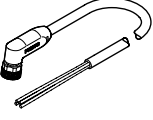
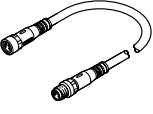
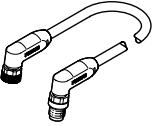
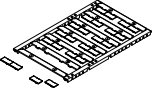
Technical data – PROFIBUS interface

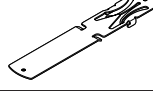
Ordering data – Accessories						
	Description				Part No.	Type
	For power supply	Straight socket, M8 x 1, 4-pin, A-coded	Open cable end, 4-wire	5.0 m	8065110	NEBL-M8G4-E-5-N-LE4
				7.5 m	8065113	NEBL-M8G4-E-7.5-N-LE4
				10.0 m	8065117	NEBL-M8G4-E-10-N-LE4
				15.0 m	8065121	NEBL-M8G4-E-15-N-LE4
		Angled socket, M8x1, 4-pin, A-coded	Open cable end, 4-wire	7.5 m	8065114	NEBL-M8W4-E-7.5-N-LE4
				10.0 m	8065118	NEBL-M8W4-E-10-N-LE4
				15.0 m	8065122	NEBL-M8W4-E-15-N-LE4
	For power transmission	Straight socket, M8 x 1, 4-pin, A-coded	Straight plug, M8 x 1, 4-pin, A-coded	0.3 m	8082904	NEBL-M8G4-E-0.3-N-M8G4
				0.5 m	8065102	NEBL-M8G4-E-0.5-N-M8G4
				1.0 m	8065104	NEBL-M8G4-E-1-N-M8G4
				2.0 m	8065106	NEBL-M8G4-E-2-N-M8G4
				5.0 m	8065108	NEBL-M8G4-E-5-N-M8G4
				7.5 m	8065111	NEBL-M8G4-E-7.5-N-M8G4
				10.0 m	8065115	NEBL-M8G4-E-10-N-M8G4
				15.0 m	8065119	NEBL-M8G4-E-15-N-M8G4
		Angled socket, M8x1, 4-pin, A-coded	Angled plug, M8x1, 4-pin, A-coded	0.3 m	8146577	NEBL-M8W4-E-0.3-N-M8W4
				0.5 m	8065103	NEBL-M8W4-E-0.5-N-M8W4
				1.0 m	8065105	NEBL-M8W4-E-1-N-M8W4
				2.0 m	8065107	NEBL-M8W4-E-2-N-M8W4
				5.0 m	8065109	NEBL-M8W4-E-5-N-M8W4
				7.5 m	8065112	NEBL-M8W4-E-7.5-N-M8W4
				10.0 m	8065116	NEBL-M8W4-E-10-N-M8W4
				15.0 m	8065120	NEBL-M8W4-E-15-N-M8W4
Ordering data – Accessories						
	Description			Pack size	Part No.	Type
Inscription label						
	For modules CPX-AP-I	Size 6x 12.5 mm, 10 frames with 24 pieces each		240	8087174	ASLR-L-X4-612-P240
Cover cap						
	For sealing unused connections		For connection M8x1	10	177672	ISK-M8
H-rail mounting						
	For mounting a module on H-rails to EN 60715			–	8095158	CAFM-X4-H

Technical data – EtherCAT interface

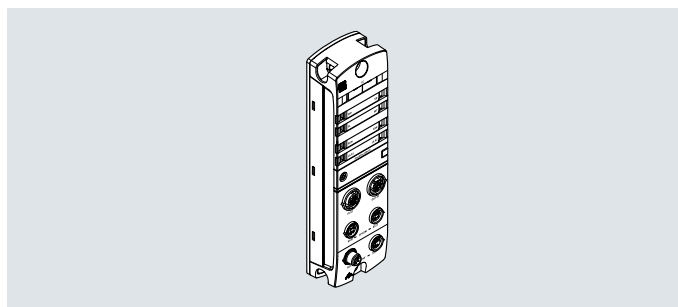

Interface for operating the automation system CPX-AP-I on EtherCAT. Data is transferred on the basis of the Ethernet standard for communication in an industrial environment.

General technical data

Fieldbus interface		
Protocol		EtherCAT
Function		Bus connection incoming/outgoing
Transmission rate	[Mbps]	100
Type		Ethernet
Connection type		2 x socket
Connection technology		M12x1, D-coded to EN 61076-2-101
Number of pins/wires		4
Galvanic isolation		Yes
Max. address volume for outputs	[byte]	2048
Max. address capacity inputs	[byte]	2048
Communication interface		
Protocol		AP
Function		System communication XF10 IN / XF20 OUT
Connection type		2 x socket
Connection technology		M8x1, D-coded to EN 61076-2-114
Number of pins/wires		4
Screening		Yes

Technical data – EtherCAT interface

General data		
Configuration support		ESI file
Maximum number of modules		80
Diagnostics via LED		Diagnostics per module
		EtherCAT RUN
		Power supply, electronics/sensors
		Power supply load
		System diagnostics
Diagnostics via bus		Maintenance required
		Load switch-off
		Load overvoltage
		Load undervoltage
		Electronics/sensors overvoltage
		Electronics/sensors undervoltage
Diagnostics via internal communication		APDD invalid
		Communication to AP module interrupted
		Module error
		Short circuit/overload in sensor supply
		Short circuit/overload at output
Maximum cable length	[m]	Undervoltage in load supply
Information on maximum cable length		50 system communication
Reverse polarity protection		Power supply according to nominal voltage
		Yes
Technical data – Electrical components		
Nominal operating voltage, electronics/sensors	[V DC]	24
Nominal operating voltage, load	[V DC]	24
Permissible voltage fluctuations for electronics/sensors	[%]	±25
Permissible voltage fluctuations, load	[%]	±25
Note on operating voltage		SELV/PELV power supply units required
		Note voltage drop
Power failure buffering	[ms]	10
Max. power supply	[A]	2x 4
		External fuse required
Intrinsic current consumption at nominal operating voltage for electronics/sensors	[mA]	Typically 90
Intrinsic current consumption at nominal operating voltage, load	[mA]	Typically 5
Electrical connection, power supply		
Function		Incoming electronics/sensors and load
Connection type		Plug
Connection technology		M8x1, A-coded to EN 61076-2-104
Number of pins/wires		4
Electrical connection, power transmission		
Function		Outgoing electronics/sensors and load
Connection type		Socket
Connection technology		M8x1, A-coded to EN 61076-2-104
Number of pins/wires		4
Technical data – Mechanical components		
Type of mounting		Via through-hole
		On H-rail with accessories
Product weight	[g]	186
Dimensions W x L x H	[mm]	45 x 170 x 35
Tightening torque	[Nm]	1.2

Technical data – EtherCAT interface

Materials		
Housing		PA
		PC
		Nickel-plated, die-cast zinc
O-ring		FPM
Note on materials		RoHS-compliant
PWIS conformity		VDMA24364-B2-L
Operating and environmental conditions		
Ambient temperature	[°C]	-20 ... +50
Storage temperature	[°C]	-40 ... +70
Corrosion resistance class CRC ¹⁾		1
Relative humidity	[%]	5 ... 95
		Non-condensing
CE marking (see declaration of conformity) ³⁾		To EU EMC Directive ²⁾
KC mark		KC EMC
UKCA marking (see declaration of conformity)		To UK instructions for EMC
Certification		RCM
		c UL us - Listed (OL)
Certificate-issuing authority		UL E239998
Degree of protection		IP65
		IP67
Note on degree of protection		Unused connections sealed

1) Additional information: www.festo.com/x/topic/kbk

2) For information about the area of use, see the EC declaration of conformity at: www.festo.com/catalogue/... → Support/Downloads.

If the devices are subject to usage restrictions in residential, commercial or light-industrial environments, further measures for the reduction of the emitted interference may be necessary.

3) Additional information: www.festo.com/catalogue/... → Support/Downloads.

Connection and display components

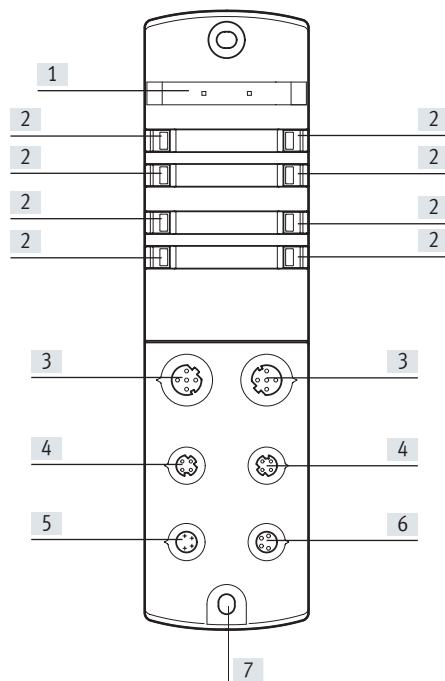

- [1] Space for inscription label
- [2] LED indicators
- [3] Network connections 1 and 2, EtherCAT
- [4] Communication interface
- [5] Electrical connection, power supply
- [6] Electrical connection, power transmission
- [7] Earthing connection

Technical data – EtherCAT interface

Dimensions

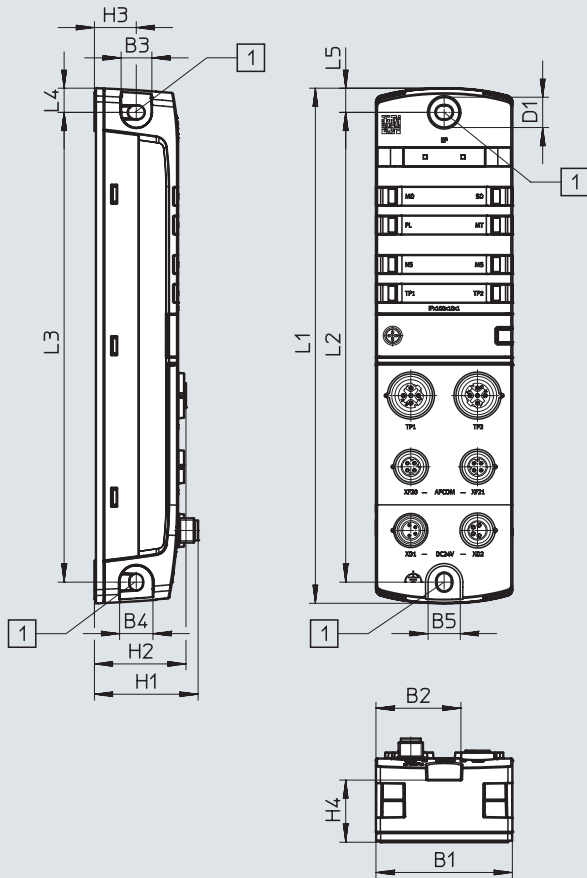

Download CAD data → www.festo.com



[1] Mounting hole for M4 screws

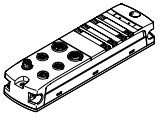

	B1	B2	B3	B4	B5	D1 ∅	H1	H2	H3	H4	L1	L2	L3	L4	L5
CPX-AP-I-EC-M12	45	35.5	10	11	11	10	34.2	30.2	13.8	20.5	170	155	155	8	8

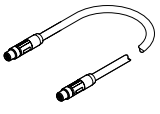
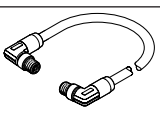
Technical data – EtherCAT interface

Ordering data				Part No.	Type	
	EtherCAT interface			8086609	CPX-AP-I-EC-M12	
Ordering data – Accessories						
Description				Part No.	Type	
Pre-assembled plugs						
	For bus connection	Straight plug, M12x1, 4-pin, D-coded		543109	NECU-M-S-D12G4-C2-ET	
Connecting cable						
	For communication interface	Straight plug, M8x1, 4-pin, D-coded	Straight plug, M8x1, 4-pin, D-coded	0.3 m	8082902	NEBC-D8G4-ES-0.3-N-S-D8G4-ET
				0.5 m	8065123	NEBC-D8G4-ES-0.5-N-S-D8G4-ET
				1.0 m	8065125	NEBC-D8G4-ES-1-N-S-D8G4-ET
				2.0 m	8065127	NEBC-D8G4-ES-2-N-S-D8G4-ET
				5.0 m	8065129	NEBC-D8G4-ES-5-N-S-D8G4-ET
				7.5 m	8065131	NEBC-D8G4-ES-7.5-N-S-D8G4-ET
				10.0 m	8065133	NEBC-D8G4-ES-10-N-S-D8G4-ET
				15.0 m	8065135	NEBC-D8G4-ES-15-N-S-D8G4-ET
				20.0 m	8146031	NEBC-D8G4-ES-20-N-S-D8G4-ET
				25.0 m	8146032	NEBC-D8G4-ES-25-N-S-D8G4-ET
				30.0 m	8146033	NEBC-D8G4-ES-30-N-S-D8G4-ET
40.0 m	8146034	NEBC-D8G4-ES-40-N-S-D8G4-ET				
50.0 m	8146035	NEBC-D8G4-ES-50-N-S-D8G4-ET				
	For communication interface	Angled plug, M8x1, 4-pin, D-coded	Angled plug, M8x1, 4-pin, D-coded	0.5 m	8065124	NEBC-D8W4-ES-0.5-N-S-D8W4-ET
				1.0 m	8065126	NEBC-D8W4-ES-1-N-S-D8W4-ET
				2.0 m	8065128	NEBC-D8W4-ES-2-N-S-D8W4-ET
				5.0 m	8065130	NEBC-D8W4-ES-5-N-S-D8W4-ET
				7.5 m	8065132	NEBC-D8W4-ES-7.5-N-S-D8W4-ET
				10.0 m	8065134	NEBC-D8W4-ES-10-N-S-D8W4-ET
				15.0 m	8065136	NEBC-D8W4-ES-15-N-S-D8W4-ET
				20.0 m	8146036	NEBC-D8W4-ES-20-N-S-D8W4-ET
				25.0 m	8146037	NEBC-D8W4-ES-25-N-S-D8W4-ET
				30.0 m	8146038	NEBC-D8W4-ES-30-N-S-D8W4-ET
				40.0 m	8146039	NEBC-D8W4-ES-40-N-S-D8W4-ET
50.0 m	8146040	NEBC-D8W4-ES-50-N-S-D8W4-ET				

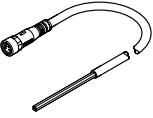
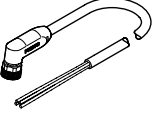
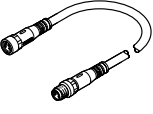
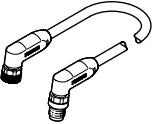
Technical data – EtherCAT interface

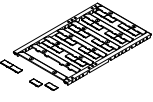
Ordering data – Accessories						
	Description				Part No.	Type
	For power supply	Straight socket, M8 x 1, 4-pin, A-coded	Open cable end, 4-wire	5.0 m	8065110	NEBL-M8G4-E-5-N-LE4
				7.5 m	8065113	NEBL-M8G4-E-7.5-N-LE4
				10.0 m	8065117	NEBL-M8G4-E-10-N-LE4
				15.0 m	8065121	NEBL-M8G4-E-15-N-LE4
		Angled socket, M8x1, 4-pin, A-coded	Open cable end, 4-wire	7.5 m	8065114	NEBL-M8W4-E-7.5-N-LE4
				10.0 m	8065118	NEBL-M8W4-E-10-N-LE4
				15.0 m	8065122	NEBL-M8W4-E-15-N-LE4
	For power transmission	Straight socket, M8 x 1, 4-pin, A-coded	Straight plug, M8 x 1, 4-pin, A-coded	0.3 m	8082904	NEBL-M8G4-E-0.3-N-M8G4
				0.5 m	8065102	NEBL-M8G4-E-0.5-N-M8G4
				1.0 m	8065104	NEBL-M8G4-E-1-N-M8G4
				2.0 m	8065106	NEBL-M8G4-E-2-N-M8G4
				5.0 m	8065108	NEBL-M8G4-E-5-N-M8G4
				7.5 m	8065111	NEBL-M8G4-E-7.5-N-M8G4
				10.0 m	8065115	NEBL-M8G4-E-10-N-M8G4
				15.0 m	8065119	NEBL-M8G4-E-15-N-M8G4
		Angled socket, M8x1, 4-pin, A-coded	Angled plug, M8x1, 4-pin, A-coded	0.3 m	8146577	NEBL-M8W4-E-0.3-N-M8W4
				0.5 m	8065103	NEBL-M8W4-E-0.5-N-M8W4
				1.0 m	8065105	NEBL-M8W4-E-1-N-M8W4
				2.0 m	8065107	NEBL-M8W4-E-2-N-M8W4
				5.0 m	8065109	NEBL-M8W4-E-5-N-M8W4
				7.5 m	8065112	NEBL-M8W4-E-7.5-N-M8W4
				10.0 m	8065116	NEBL-M8W4-E-10-N-M8W4
				15.0 m	8065120	NEBL-M8W4-E-15-N-M8W4

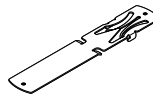
Ordering data – Accessories						
	Description			Pack size	Part No.	Type
Inscription label						
	For modules CPX-AP-I	Size 6x 12.5 mm, 10 frames with 24 pieces each		240	8087174	ASLR-L-X4-612-P240
Cover cap						
	For sealing unused connections	For connection M8x1		10	177672	ISK-M8
H-rail mounting						
	For mounting a module on H-rails to EN 60715			–	8095158	CAFM-X4-H

Technical data – EtherNet/IP interface

EtherNet/IP™

Interface for operating the automation system CPX-AP-I in an Ethernet network using the protocols EtherNet/IP or Modbus/TCP. Data is transmitted on the basis of Industrial Ethernet.

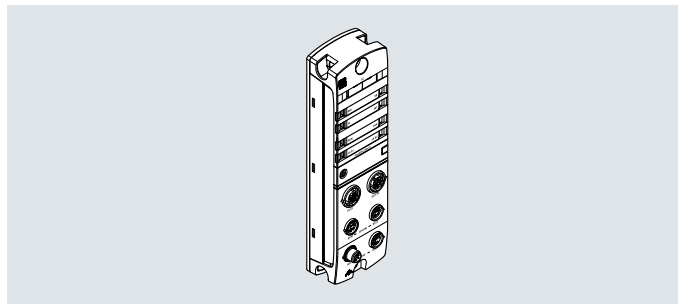
**General technical data****Fieldbus interface**

Protocol	EtherNet/IP
Function	Bus connection incoming/outgoing
Transmission rate	[Mbps] 100
Type	Ethernet
Connection type	2 x socket
Connection technology	M12x1, D-coded to EN 61076-2-101
Number of pins/wires	4
Galvanic isolation	Yes
Max. address volume for outputs	[byte] 1324
Max. address capacity inputs	[byte] 1324

Communication interface

Protocol	AP
Function	System communication XF10 IN / XF20 OUT
Connection type	2 x socket
Connection technology	M8x1, D-coded to EN 61076-2-114
Number of pins/wires	4
Screening	Yes

Technical data – EtherNet/IP interface

General data		
Configuration support		EDS file
Maximum number of modules		80
Diagnostics via LED		Diagnostics per module
		Network status EtherNet/IP
		Power supply, electronics/sensors
		Power supply load
		System diagnostics
Diagnostics via bus		Maintenance required
		Load switch-off
		Load overvoltage
		Load undervoltage
		Electronics/sensors overvoltage
		Electronics/sensors undervoltage
Diagnostics via internal communication		APDD invalid
		Communication to AP module interrupted
		Module error
		Short circuit/overload at output
		Short circuit/overload in sensor supply
Maximum cable length	[m]	50 system communication
Information on maximum cable length		Power supply according to nominal voltage
Reverse polarity protection		Yes

Technical data – Electrical components

Nominal operating voltage, electronics/sensors	[V DC]	24
Nominal operating voltage, load	[V DC]	24
Permissible voltage fluctuations for electronics/sensors	[%]	±25
Permissible voltage fluctuations, load	[%]	±25
Note on operating voltage		SELV/PELV power supply units required
		Note voltage drop
Power failure buffering	[ms]	10
Max. power supply	[A]	2x 4
		External fuse required
Intrinsic current consumption at nominal operating voltage for electronics/sensors	[mA]	Typically 90
Intrinsic current consumption at nominal operating voltage, load	[mA]	Typically 5

Electrical connection, power supply

Function		Incoming electronics/sensors and load
Connection type		Plug
Connection technology		M8x1, A-coded to EN 61076-2-104
Number of pins/wires		4

Electrical connection, power transmission

Function		Outgoing electronics/sensors and load
Connection type		Socket
Connection technology		M8x1, A-coded to EN 61076-2-104
Number of pins/wires		4

Technical data – Mechanical components

Type of mounting		Via through-hole
		On H-rail with accessories
Product weight	[g]	194
Dimensions W x L x H	[mm]	45 x 170 x 35
Tightening torque	[Nm]	1.2

Technical data – EtherNet/IP interface

Materials		
Housing		PA
		PC
		Nickel-plated, die-cast zinc
O-ring		FPM
Note on materials		RoHS-compliant
PWIS conformity		VDMA24364-B2-L
Operating and environmental conditions		
Ambient temperature	[°C]	-20 ... +50
Storage temperature	[°C]	-40 ... +70
Corrosion resistance class CRC ¹⁾		1
Relative humidity	[%]	5 ... 95
		Non-condensing
CE marking (see declaration of conformity) ³⁾		To EU EMC Directive ²⁾
KC mark		KC EMC
UKCA marking (see declaration of conformity)		To UK instructions for EMC
Certification		RCM
		c UL us - Listed (OL)
Certificate-issuing authority		UL E239998
Degree of protection		IP65
		IP67
Note on degree of protection		Unused connections sealed

1) Additional information: www.festo.com/x/topic/kbk

2) For information about the area of use, see the EC declaration of conformity at: www.festo.com/catalogue/... → Support/Downloads.

If the devices are subject to usage restrictions in residential, commercial or light-industrial environments, further measures for the reduction of the emitted interference may be necessary.

3) Additional information: www.festo.com/catalogue/... → Support/Downloads.

Connection and display components

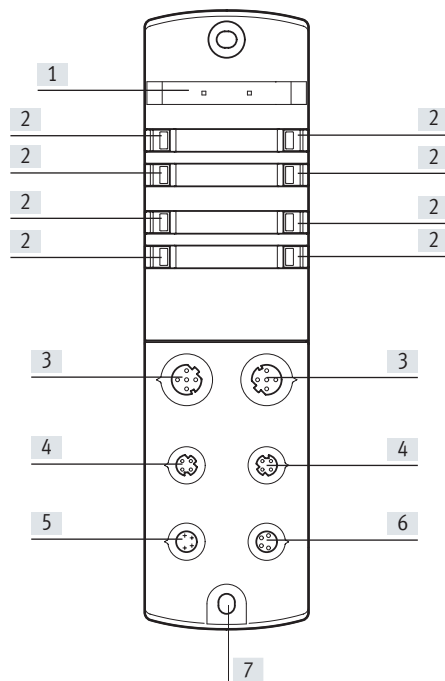

- [1] Space for inscription label
- [2] LED indicators
- [3] Network connections 1 and 2, EtherNet/IP
- [4] Communication interface
- [5] Electrical connection, power supply
- [6] Electrical connection, power transmission
- [7] Earthing connection

Technical data – EtherNet/IP interface

Dimensions

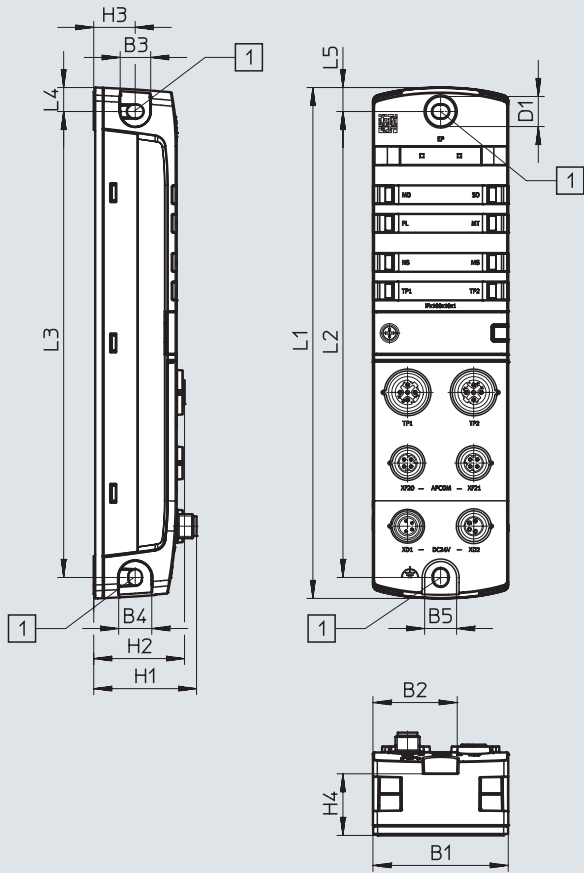

Download CAD data → www.festo.com



[1] Mounting hole for M4 screws

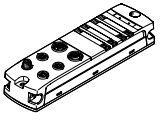

	B1	B2	B3	B4	B5	D1	H1	H2	H3	H4	L1	L2	L3	L4	L5
CPX-AP-I-EP-M12	45	35.5	10	11	11	10 ∅	34.2	30.2	13.8	20.5	170	155	155	8	8

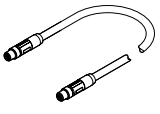
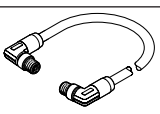
Technical data – EtherNet/IP interface

Ordering data		Part No.	Type			
	EtherNet/IP interface	8086610	CPX-AP-I-EP-M12			
Ordering data – Accessories						
Description		Part No.	Type			
Pre-assembled plugs						
	For bus connection	Straight plug, M12x1, 4-pin, D-coded	543109 NECU-M-S-D12G4-C2-ET			
Connecting cable						
	For communication interface	Straight plug, M8x1, 4-pin, D-coded	Straight plug, M8x1, 4-pin, D-coded	0.3 m	8082902	NEBC-D8G4-ES-0.3-N-S-D8G4-ET
				0.5 m	8065123	NEBC-D8G4-ES-0.5-N-S-D8G4-ET
				1.0 m	8065125	NEBC-D8G4-ES-1-N-S-D8G4-ET
				2.0 m	8065127	NEBC-D8G4-ES-2-N-S-D8G4-ET
				5.0 m	8065129	NEBC-D8G4-ES-5-N-S-D8G4-ET
				7.5 m	8065131	NEBC-D8G4-ES-7.5-N-S-D8G4-ET
				10.0 m	8065133	NEBC-D8G4-ES-10-N-S-D8G4-ET
				15.0 m	8065135	NEBC-D8G4-ES-15-N-S-D8G4-ET
				20.0 m	8146031	NEBC-D8G4-ES-20-N-S-D8G4-ET
				25.0 m	8146032	NEBC-D8G4-ES-25-N-S-D8G4-ET
				30.0 m	8146033	NEBC-D8G4-ES-30-N-S-D8G4-ET
				40.0 m	8146034	NEBC-D8G4-ES-40-N-S-D8G4-ET
				50.0 m	8146035	NEBC-D8G4-ES-50-N-S-D8G4-ET
	For communication interface	Angled plug, M8x1, 4-pin, D-coded	Angled plug, M8x1, 4-pin, D-coded	0.5 m	8065124	NEBC-D8W4-ES-0.5-N-S-D8W4-ET
				1.0 m	8065126	NEBC-D8W4-ES-1-N-S-D8W4-ET
				2.0 m	8065128	NEBC-D8W4-ES-2-N-S-D8W4-ET
				5.0 m	8065130	NEBC-D8W4-ES-5-N-S-D8W4-ET
				7.5 m	8065132	NEBC-D8W4-ES-7.5-N-S-D8W4-ET
				10.0 m	8065134	NEBC-D8W4-ES-10-N-S-D8W4-ET
				15.0 m	8065136	NEBC-D8W4-ES-15-N-S-D8W4-ET
				20.0 m	8146036	NEBC-D8W4-ES-20-N-S-D8W4-ET
				25.0 m	8146037	NEBC-D8W4-ES-25-N-S-D8W4-ET
				30.0 m	8146038	NEBC-D8W4-ES-30-N-S-D8W4-ET
				40.0 m	8146039	NEBC-D8W4-ES-40-N-S-D8W4-ET
50.0 m	8146040	NEBC-D8W4-ES-50-N-S-D8W4-ET				

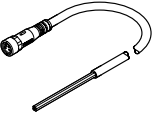
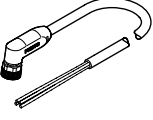
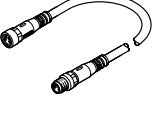
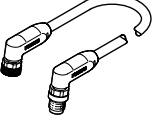
Technical data – EtherNet/IP interface

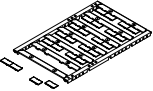
Ordering data – Accessories						
	Description				Part No.	Type
	For power supply	Straight socket, M8 x 1, 4-pin, A-coded	Open cable end, 4-wire	5.0 m	8065110	NEBL-M8G4-E-5-N-LE4
				7.5 m	8065113	NEBL-M8G4-E-7.5-N-LE4
				10.0 m	8065117	NEBL-M8G4-E-10-N-LE4
				15.0 m	8065121	NEBL-M8G4-E-15-N-LE4
	For power supply	Angled socket, M8x1, 4-pin, A-coded	Open cable end, 4-wire	7.5 m	8065114	NEBL-M8W4-E-7.5-N-LE4
				10.0 m	8065118	NEBL-M8W4-E-10-N-LE4
				15.0 m	8065122	NEBL-M8W4-E-15-N-LE4
	For power transmission	Straight socket, M8 x 1, 4-pin, A-coded	Straight plug, M8 x 1, 4-pin, A-coded	0.3 m	8082904	NEBL-M8G4-E-0.3-N-M8G4
				0.5 m	8065102	NEBL-M8G4-E-0.5-N-M8G4
				1.0 m	8065104	NEBL-M8G4-E-1-N-M8G4
				2.0 m	8065106	NEBL-M8G4-E-2-N-M8G4
				5.0 m	8065108	NEBL-M8G4-E-5-N-M8G4
				7.5 m	8065111	NEBL-M8G4-E-7.5-N-M8G4
				10.0 m	8065115	NEBL-M8G4-E-10-N-M8G4
				15.0 m	8065119	NEBL-M8G4-E-15-N-M8G4
	For power transmission	Angled socket, M8x1, 4-pin, A-coded	Angled plug, M8x1, 4-pin, A-coded	0.3 m	8146577	NEBL-M8W4-E-0.3-N-M8W4
				0.5 m	8065103	NEBL-M8W4-E-0.5-N-M8W4
				1.0 m	8065105	NEBL-M8W4-E-1-N-M8W4
				2.0 m	8065107	NEBL-M8W4-E-2-N-M8W4
				5.0 m	8065109	NEBL-M8W4-E-5-N-M8W4
				7.5 m	8065112	NEBL-M8W4-E-7.5-N-M8W4
				10.0 m	8065116	NEBL-M8W4-E-10-N-M8W4
				15.0 m	8065120	NEBL-M8W4-E-15-N-M8W4

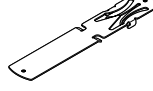
Ordering data – Accessories						
	Description			Pack size	Part No.	Type
Inscription label						
	For modules CPX-AP-I	Size 6x 12.5 mm, 10 frames with 24 pieces each		240	8087174	ASLR-L-X4-612-P240
Cover cap						
	For sealing unused connections	For connection M8x1		10	177672	ISK-M8
H-rail mounting						
	For mounting a module on H-rails to EN 60715			–	8095158	CAFM-X4-H

Technical data – IO-Link master

Function

The IO-Link master has 4 IO-Link connections, which enable any IO-Link components and Festo components with an I-Port connection to be linked up to the automation system CPX-AP-I.

- IO-Link master
- Connection M12x1, 5-pin
- Status and error indication via LED

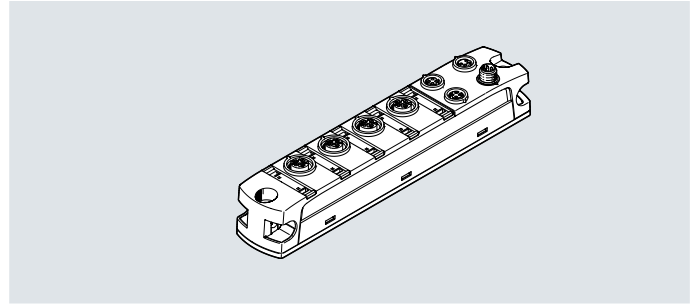

Description

The IO-Link communication system is used to exchange serial data from decentralised function modules (devices) at the field level.

The IO-Link master provides four external IO-Link interfaces, at each of which a device can be connected.

The connection type corresponds to a star topology, which means that only one device can be connected to each port.

In the factory settings, each IO-Link port has an address space with 9 bytes of input data and 8 bytes of output data.

Address space, master port and the connected devices can be parameterised with the aid of the IO-Link device tool.

DIL switches are available for a range of further settings.

A 30-day trial version of the IO-Link device tool can be downloaded from the Support Portal. A licence is required at the end of the trial period.

The necessary licence for continued use can be purchased via the Festo AppWorld.

General technical data	
Protocol	IO-Link
IO-Link	
Protocol version	Master V 1.1
Communication mode	Configurable via software
Communication mode	SIO, COM1 (4.8 kBd), COM2 (38.4 kBd), COM3 (230.4 kBd)
Port class	B
No. of ports	4
Process data width OUT	Can be parameterised, 8 ... 128 bytes
Process data width IN	Can be parameterised, 12 ... 132 bytes
Minimum cycle time	Depending on minimum supported cycle time of connected IO-Link device
Communication	C/Q LED, green
Electrical connection, IO-Link	
Connection type	4 x socket
Connection technology	M12x1, A-coded to EN 61076-2-101
Number of pins/wires	5
Communication interface	
Protocol	AP
Function	System communication XF10 IN / XF20 OUT
Connection type	2 x socket
Connection technology	M8x1, D-coded to EN 61076-2-114
Number of pins/wires	4
Screening	Yes

Technical data – IO-Link master

General data		
Diagnostics via LED		Diagnostics per channel
		Diagnostics per module
		Power supply load
		Status per channel
		Status per module
Diagnostics via internal communication		IO-Link event
		Short circuit/overload in sensor supply
		Electronics/sensors overvoltage
		Load overvoltage
		Electronics/sensors undervoltage
Maximum cable length	[m]	20 for IO-Link operation
	[m]	50 system communication
Reverse polarity protection		Yes
Technical data – Electrical components		
Nominal operating voltage, electronics/sensors	[V DC]	24
Permissible voltage fluctuations for electronics/sensors	[%]	±25
Nominal operating voltage, load	[V DC]	24
Permissible voltage fluctuations, load	[%]	±25
Note on operating voltage		Note voltage drop SELV/PELV power supply units required
Power failure buffering	[ms]	10
Max. power supply	[A]	2x 4
		External fuse required
Intrinsic current consumption at nominal operating voltage for electronics/sensors	[mA]	Typically 55
Intrinsic current consumption at nominal operating voltage, load	[mA]	Typically 5
Electrical connection, power supply		
Function		Incoming electronics/sensors and load
Connection type		Plug
Connection technology		M8x1, A-coded to EN 61076-2-104
Number of pins/wires		4
Electrical connection, power transmission		
Function		Outgoing electronics/sensors and load
Connection type		Socket
Connection technology		M8x1, A-coded to EN 61076-2-104
Number of pins/wires		4
Technical data – Mechanical components		
Type of mounting		Via through-hole
		On H-rail with accessories
Product weight	[g]	126
Dimensions W x L x H	[mm]	30 x 170 x 35
Materials		
Housing		PA
		PC
		Nickel-plated, die-cast zinc
O-ring		FPM
Note on materials		RoHS-compliant
PWIS conformity		VDMA24364-B2-L

Technical data – IO-Link master

Operating and environmental conditions		
Ambient temperature	[°C]	-20 ... +50
Storage temperature	[°C]	-40 ... +70
Corrosion resistance class CRC ¹⁾		1
Relative humidity	[%]	5 ... 95
		Non-condensing
CE marking (see declaration of conformity) ³⁾		To EU EMC Directive ²⁾
KC mark		KC EMC
UKCA marking (see declaration of conformity)		To UK instructions for EMC
Certification		RCM
		c UL us - Listed (OL)
Certificate-issuing authority		UL E239998
Degree of protection		IP65
		IP67
Note on degree of protection		Unused connections sealed

1) Additional information: www.festo.com/x/topic/kbk

2) For information about the area of use, see the EC declaration of conformity at: www.festo.com/catalogue/... → Support/Downloads.

If the devices are subject to usage restrictions in residential, commercial or light-industrial environments, further measures for the reduction of the emitted interference may be necessary.

3) Additional information: www.festo.com/catalogue/... → Support/Downloads.

Connection and display components

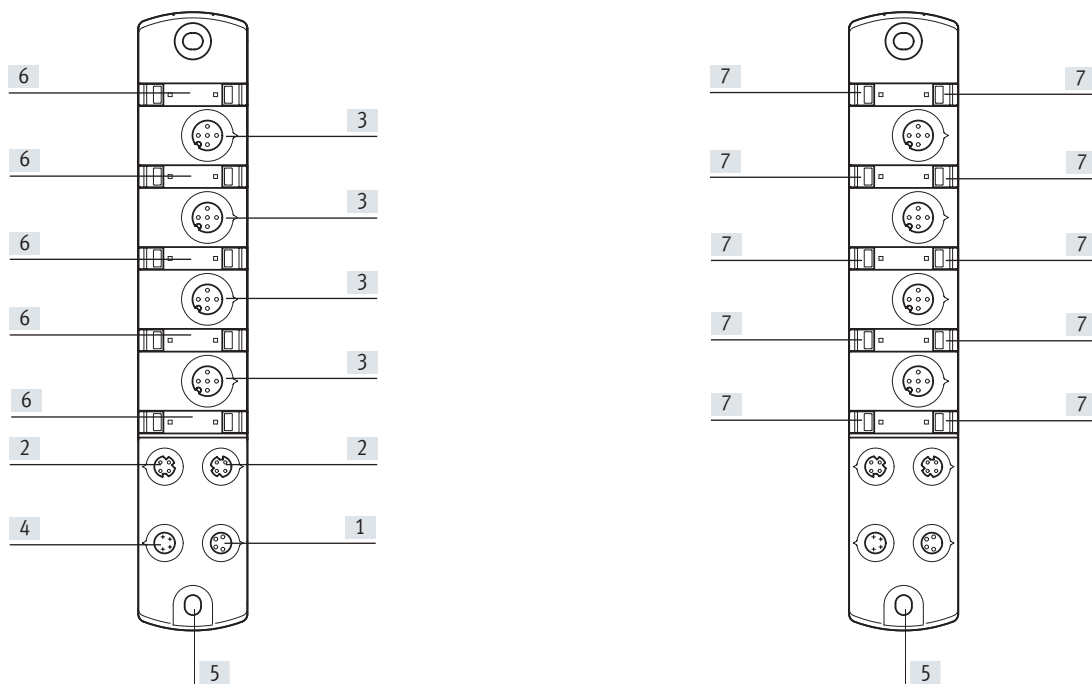

[1] Electrical connection, power transmission

[2] Communication interface

[3] Electrical connection, inputs

[4] Electrical connection, power supply

[5] Earthing connection

[6] Space for inscription label

[7] LED indicators

Technical data – IO-Link master

Dimensions

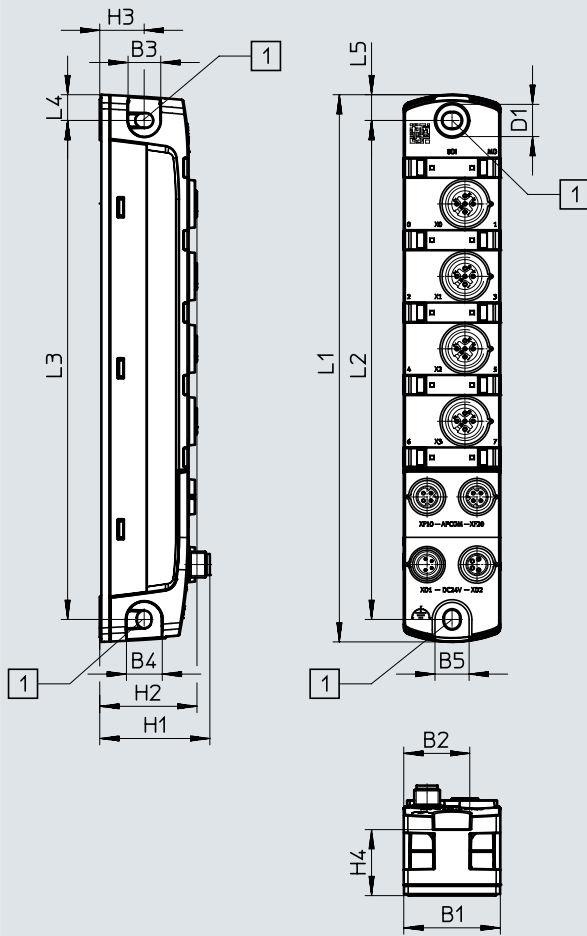

Download CAD data → www.festo.com



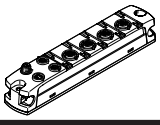

[1] Mounting hole for M4 screws

	B1	B2	B3	B4	B5	D1 ∅	H1	H2	H3	H4	L1	L2	L3	L4	L5
CPX-AP-I-4IOL-M12	30	20.5	10	11	11	10	34.2	30.2	13.8	20.5	170	155	155	8	8

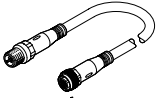
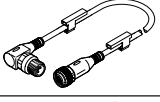
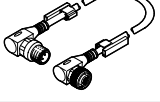
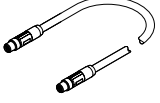
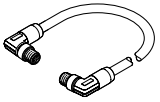
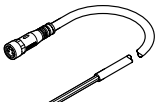
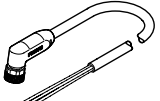
Technical data – IO-Link master

Ordering data				Part No.	Type	
	IO-Link master	Electrical connection, IO-Link 4x sockets M12x1, 5-pin		8086604	CPX-AP-I-4IOL-M12	
Ordering data – Accessories						
Description				Part No.	Type	
Pre-assembled plugs						
	For IO-Link	Straight plug, M12x1, 5-pin, A-coded	Screw terminal	175487	SEA-M12-5GS-PG7	
Connecting cable						
	For IO-Link	Straight socket, M12x1, 5-pin, A-coded	Straight plug, M12 x 1, 5-pin, A-coded	0.5 m	800208	NEBU-M12G5-K-0.5-M12G4
				5.0 m	574321	NEBU-M12G5-E-5-Q8N-M12G5
				7.5 m	574322	NEBU-M12G5-E-7.5-Q8N-M12G5
			Angled plug, M12x1, 5-pin, A-coded	0.5 m	8003617	NEBU-M12G5-K-0.5-M12W5
				2.0 m	8003618	NEBU-M12G5-K-2-M12W5
		Angled socket, M12x1, 5-pin, A-coded	Angled plug, M12x1, 5-pin, A-coded	0.5 m	570733	NEBU-M12W5-K-0.5-M12W5
				2.0 m	570734	NEBU-M12W5-K-2-M12W5
	For communication interface	Straight plug, M8x1, 4-pin, D-coded	Straight plug, M8x1, 4-pin, D-coded	0.3 m	8082902	NEBC-D8G4-ES-0.3-N-S-D8G4-ET
				0.5 m	8065123	NEBC-D8G4-ES-0.5-N-S-D8G4-ET
				1.0 m	8065125	NEBC-D8G4-ES-1-N-S-D8G4-ET
				2.0 m	8065127	NEBC-D8G4-ES-2-N-S-D8G4-ET
				5.0 m	8065129	NEBC-D8G4-ES-5-N-S-D8G4-ET
				7.5 m	8065131	NEBC-D8G4-ES-7.5-N-S-D8G4-ET
				10.0 m	8065133	NEBC-D8G4-ES-10-N-S-D8G4-ET
				15.0 m	8065135	NEBC-D8G4-ES-15-N-S-D8G4-ET
				20.0 m	8146031	NEBC-D8G4-ES-20-N-S-D8G4-ET
				25.0 m	8146032	NEBC-D8G4-ES-25-N-S-D8G4-ET
				30.0 m	8146033	NEBC-D8G4-ES-30-N-S-D8G4-ET
				40.0 m	8146034	NEBC-D8G4-ES-40-N-S-D8G4-ET
				50.0 m	8146035	NEBC-D8G4-ES-50-N-S-D8G4-ET
		Angled plug, M8x1, 4-pin, D-coded	Angled plug, M8x1, 4-pin, D-coded	0.5 m	8065124	NEBC-D8W4-ES-0.5-N-S-D8W4-ET
				1.0 m	8065126	NEBC-D8W4-ES-1-N-S-D8W4-ET
				2.0 m	8065128	NEBC-D8W4-ES-2-N-S-D8W4-ET
				5.0 m	8065130	NEBC-D8W4-ES-5-N-S-D8W4-ET
				7.5 m	8065132	NEBC-D8W4-ES-7.5-N-S-D8W4-ET
				10.0 m	8065134	NEBC-D8W4-ES-10-N-S-D8W4-ET
				15.0 m	8065136	NEBC-D8W4-ES-15-N-S-D8W4-ET
				20.0 m	8146036	NEBC-D8W4-ES-20-N-S-D8W4-ET
				25.0 m	8146037	NEBC-D8W4-ES-25-N-S-D8W4-ET
				30.0 m	8146038	NEBC-D8W4-ES-30-N-S-D8W4-ET
				40.0 m	8146039	NEBC-D8W4-ES-40-N-S-D8W4-ET
				50.0 m	8146040	NEBC-D8W4-ES-50-N-S-D8W4-ET
					For power supply	Straight socket, M8 x 1, 4-pin, A-coded
7.5 m	8065113	NEBL-M8G4-E-7.5-N-LE4				
10.0 m	8065117	NEBL-M8G4-E-10-N-LE4				
15.0 m	8065121	NEBL-M8G4-E-15-N-LE4				
		Angled socket, M8x1, 4-pin, A-coded	Open cable end, 4-wire	7.5 m	8065114	NEBL-M8W4-E-7.5-N-LE4
				10.0 m	8065118	NEBL-M8W4-E-10-N-LE4
				15.0 m	8065122	NEBL-M8W4-E-15-N-LE4

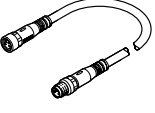
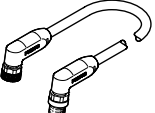
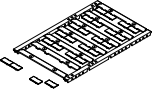
Technical data – IO-Link master

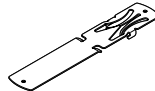
Ordering data – Accessories						
Description				Part No.	Type	
Connecting cable						
	For power transmission	Straight socket, M8 x 1, 4-pin, A-coded	Straight plug, M8 x 1, 4-pin, A-coded	0.3 m	8082904	NEBL-M8G4-E-0.3-N-M8G4
				0.5 m	8065102	NEBL-M8G4-E-0.5-N-M8G4
				1.0 m	8065104	NEBL-M8G4-E-1-N-M8G4
				2.0 m	8065106	NEBL-M8G4-E-2-N-M8G4
				5.0 m	8065108	NEBL-M8G4-E-5-N-M8G4
				7.5 m	8065111	NEBL-M8G4-E-7.5-N-M8G4
				10.0 m	8065115	NEBL-M8G4-E-10-N-M8G4
				15.0 m	8065119	NEBL-M8G4-E-15-N-M8G4
						Angled socket, M8x1, 4-pin, A-coded
0.5 m	8065103	NEBL-M8W4-E-0.5-N-M8W4				
1.0 m	8065105	NEBL-M8W4-E-1-N-M8W4				
2.0 m	8065107	NEBL-M8W4-E-2-N-M8W4				
5.0 m	8065109	NEBL-M8W4-E-5-N-M8W4				
7.5 m	8065112	NEBL-M8W4-E-7.5-N-M8W4				
10.0 m	8065116	NEBL-M8W4-E-10-N-M8W4				
15.0 m	8065120	NEBL-M8W4-E-15-N-M8W4				
Ordering data – Accessories						
Description				Pack size	Part No.	Type
Inscription label						
	For modules CPX-AP-I	Size 6x 12.5 mm, 10 frames with 24 pieces each		240	8087174	ASLR-L-X4-612-P240
Cover cap						
	For sealing unused connections	For connection M8x1		10	165592	ISK-M12
H-rail mounting						
	For mounting a module on H-rails to EN 60715			–	8095158	CAFM-X4-H

Technical data – Digital 4-way input modules

Function

Digital input modules facilitate the connection of electric sensors to IEC 61131-2 type 3 (inductive, capacitive) with an operating voltage of 24 V DC.

- Input modules for 24 V DC operating voltage
- Connection M8x1, 3-pin
- Status and error indication via LED

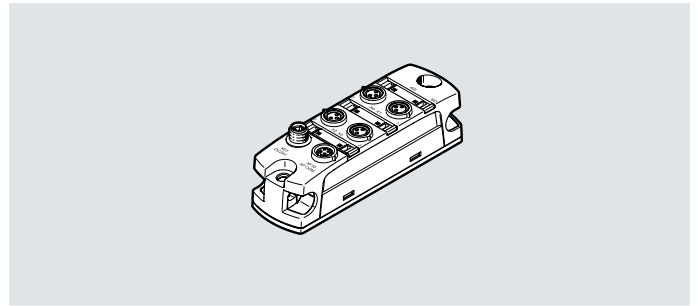

General technical data		
Type		CPX-AP-I-4DI-M8-3P
Number of inputs		4
Electrical connection, input		
Function		Digital input
Connection type		4 x socket
Connection technology		M8x1, A-coded to EN 61076-2-104
Number of pins/wires		3
Switching logic at inputs		PNP (positive switching) 2-wire sensors to IEC 61131-2 3-wire sensors to IEC 61131-2
Characteristic curve of inputs		To IEC 61131-2, type 3
Switching level	[V]	Signal 0: ≤5
	[V]	Signal 1: ≥11
Fuse protection inputs (short circuit)		Internal electronic fuse per module
Input debounce time	[ms]	0.1
	[ms]	3
	[ms]	10
	[ms]	20
Communication interface		
Protocol		AP
Function		System communication XF10 IN
Connection type		Socket
Connection technology		M8x1, D-coded to EN 61076-2-114
Number of pins/wires		4
Screening		Yes
General data		
Electrical isolation between channel and internal communication		Yes
Electrical isolation between channels		No
Diagnostics via LED		Diagnostics per module Status per channel
Diagnostics via internal communication		Short circuit/overload in sensor supply Electronics/sensors overvoltage Electronics/sensors undervoltage
Maximum cable length	[m]	30 inputs
	[m]	50 system communication
Reverse polarity protection		Yes

Technical data – Digital 4-way input modules

Technical data – Electrical components		
Nominal operating voltage, electronics/sensors	[V DC]	24
Permissible voltage fluctuations for electronics/sensors	[%]	±25
Note on operating voltage		Note voltage drop SELV/PELV power supply units required
Power failure buffering	[ms]	10
Max. power supply	[A]	2x 4 External fuse required
Max. residual current of inputs per module	[A]	0.8
Intrinsic current consumption at nominal operating voltage for electronics/sensors	[mA]	Typically 32
Electrical connection, power supply		
Function		Incoming electronics/sensors and load
Connection type		Plug
Connection technology		M8x1, A-coded to EN 61076-2-104
Number of pins/wires		4
Technical data – Mechanical components		
Type of mounting		Via through-hole
Product weight	[g]	81
Dimensions W x L x H	[mm]	30 x 102.5 x 35
Materials		
Housing		PA PC Nickel-plated, die-cast zinc
Seals		NBR
O-ring		FPM
Note on materials		RoHS-compliant
PWIS conformity		VDMA24364-B2-L
Operating and environmental conditions		
Ambient temperature	[°C]	-20 ... +50
Storage temperature	[°C]	-40 ... +70
Corrosion resistance class CRC ¹⁾		1
Relative humidity	[%]	5 ... 95 Non-condensing
CE marking (see declaration of conformity) ³⁾		To EU EMC Directive ²⁾
KC mark		KC EMC
UKCA marking (see declaration of conformity)		To UK instructions for EMC
Certification		RCM c UL us - Listed (OL)
Certificate-issuing authority		UL E239998
Degree of protection		IP65 IP67
Note on degree of protection		Unused connections sealed

1) Additional information: www.festo.com/x/topic/kbk2) For information about the area of use, see the EC declaration of conformity at: www.festo.com/catalogue/... → Support/Downloads.

If the devices are subject to usage restrictions in residential, commercial or light-industrial environments, further measures for the reduction of the emitted interference may be necessary.

3) Additional information: www.festo.com/catalogue/... → Support/Downloads.

Technical data – Digital 4-way input modules

Connection and display components

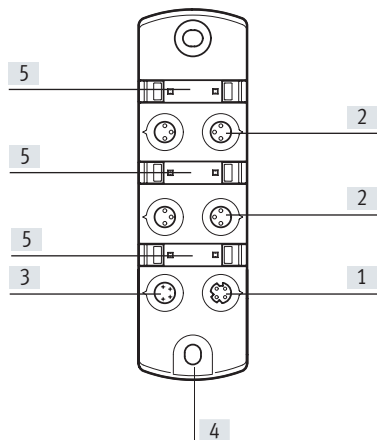

- [1] Communication interface
- [2] Electrical connection, inputs

- [3] Electrical connection, power supply

- [4] Earthing connection
- [5] Space for inscription label

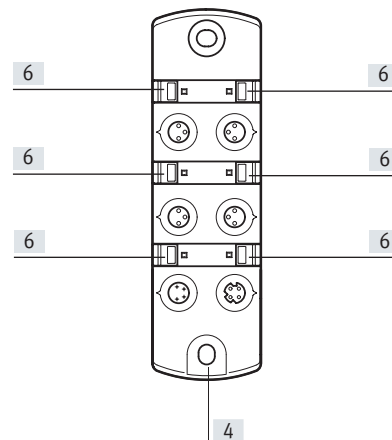

- [6] LED indicators

Technical data – Digital 4-way input modules

Dimensions

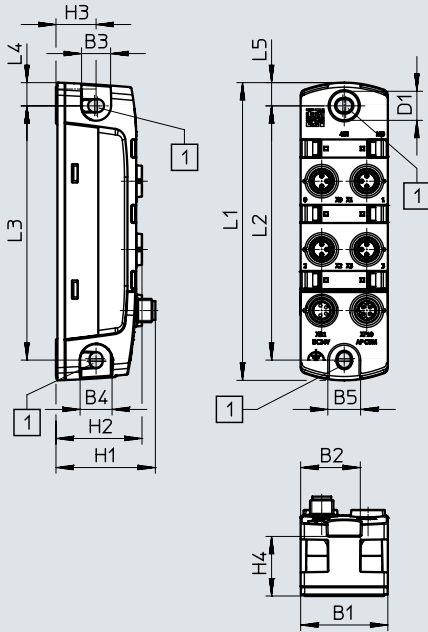

Download CAD data → www.festo.com





[1] Mounting hole for M4 screws

	B1	B2	B3	B4	B5	D1 ∅	H1	H2	H3	H4	L1	L2	L3	L4	L5
CPX-AP-I-4DI-M8-3P	30	20.5	10	11	11	10	34.2	29.6	13.8	20.5	102.5	87.5	87.5	8	8

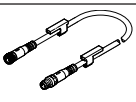
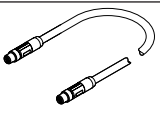
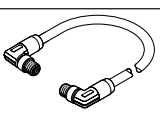
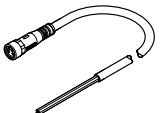
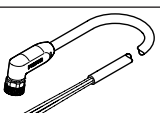
Technical data – Digital 4-way input modules

Ordering data				Part No.	Type	
	Digital input module	Electrical connection input 4x socket, 3-pin, M8x1		8086605	CPX-AP-I-4DI-M8-3P	
Ordering data – Accessories						
Description				Part No.	Type	
Pre-assembled plugs						
	For inputs	Straight plug, M8x1, 3-pin, A-coded	Screw terminal	192009	SEA-3GS-M8-S	
			Solder connection	18696	SEA-GS-M8	
Connecting cable						
	For inputs	Straight plug, M8x1, 3-pin, A-coded	Straight socket, M8 x 1, 3-pin, A-coded	0.5 m	541346	NEBU-M8G3-K-0.5-M8G3
				1.0 m	541347	NEBU-M8G3-K-1-M8G3
				1.5 m	8003133	NEBU-M8G3-K-1.5-M8G3
				2.0 m	8003131	NEBU-M8G3-K-2-M8G3
				2.5 m	541348	NEBU-M8G3-K-2.5-M8G3
				3.0 m	8003132	NEBU-M8G3-K-3-M8G3
				3.5 m	559364	NEBU-M8G3-E-3.5-M8G3
				5.0 m	541349	NEBU-M8G3-K-5-M8G3
				10.0 m	569844	NEBU-M8G3-K-10-M8G3
					For communication interface	Straight plug, M8x1, 4-pin, D-coded
0.5 m	8065123	NEBC-D8G4-ES-0.5-N-S-D8G4-ET				
1.0 m	8065125	NEBC-D8G4-ES-1-N-S-D8G4-ET				
2.0 m	8065127	NEBC-D8G4-ES-2-N-S-D8G4-ET				
5.0 m	8065129	NEBC-D8G4-ES-5-N-S-D8G4-ET				
7.5 m	8065131	NEBC-D8G4-ES-7.5-N-S-D8G4-ET				
10.0 m	8065133	NEBC-D8G4-ES-10-N-S-D8G4-ET				
15.0 m	8065135	NEBC-D8G4-ES-15-N-S-D8G4-ET				
20.0 m	8146031	NEBC-D8G4-ES-20-N-S-D8G4-ET				
25.0 m	8146032	NEBC-D8G4-ES-25-N-S-D8G4-ET				
30.0 m	8146033	NEBC-D8G4-ES-30-N-S-D8G4-ET				
40.0 m	8146034	NEBC-D8G4-ES-40-N-S-D8G4-ET				
50.0 m	8146035	NEBC-D8G4-ES-50-N-S-D8G4-ET				
		Angled plug, M8x1, 4-pin, D-coded	Angled plug, M8x1, 4-pin, D-coded	0.5 m	8065124	NEBC-D8W4-ES-0.5-N-S-D8W4-ET
				1.0 m	8065126	NEBC-D8W4-ES-1-N-S-D8W4-ET
				2.0 m	8065128	NEBC-D8W4-ES-2-N-S-D8W4-ET
				5.0 m	8065130	NEBC-D8W4-ES-5-N-S-D8W4-ET
				7.5 m	8065132	NEBC-D8W4-ES-7.5-N-S-D8W4-ET
				10.0 m	8065134	NEBC-D8W4-ES-10-N-S-D8W4-ET
				15.0 m	8065136	NEBC-D8W4-ES-15-N-S-D8W4-ET
				20.0 m	8146036	NEBC-D8W4-ES-20-N-S-D8W4-ET
				25.0 m	8146037	NEBC-D8W4-ES-25-N-S-D8W4-ET
				30.0 m	8146038	NEBC-D8W4-ES-30-N-S-D8W4-ET
				40.0 m	8146039	NEBC-D8W4-ES-40-N-S-D8W4-ET
				50.0 m	8146040	NEBC-D8W4-ES-50-N-S-D8W4-ET
					For power supply	Straight socket, M8 x 1, 4-pin, A-coded
7.5 m	8065113	NEBL-M8G4-E-7.5-N-LE4				
10.0 m	8065117	NEBL-M8G4-E-10-N-LE4				
15.0 m	8065121	NEBL-M8G4-E-15-N-LE4				
		Angled socket, M8x1, 4-pin, A-coded	Open cable end, 4-wire	7.5 m	8065114	NEBL-M8W4-E-7.5-N-LE4
				10.0 m	8065118	NEBL-M8W4-E-10-N-LE4
				15.0 m	8065122	NEBL-M8W4-E-15-N-LE4

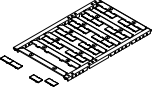
Technical data – Digital 4-way input modules

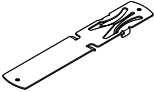
Ordering data – Accessories					
	Description		Pack size	Part No.	Type
Inscription label					
	For modules CPX-AP-I	Size 6x 12.5 mm, 10 frames with 24 pieces each	240	8087174	ASLR-L-X4-612-P240
Cover cap					
	For sealing unused connections	For connection M8x1	10	177672	ISK-M8
H-rail mounting					
	For mounting a module on H-rails to EN 60715		–	8095158	CAF-M-X4-H

Technical data – Digital 8-way input modules

Function

Digital input modules facilitate the connection of electric sensors to IEC 61131-2 type 3 (inductive, capacitive) with an operating voltage of 24 V DC.

- Input modules for 24 V DC operating voltage
- Connection M8x1 3-pin or M12x1 5-pin
- Status and error indication via LED

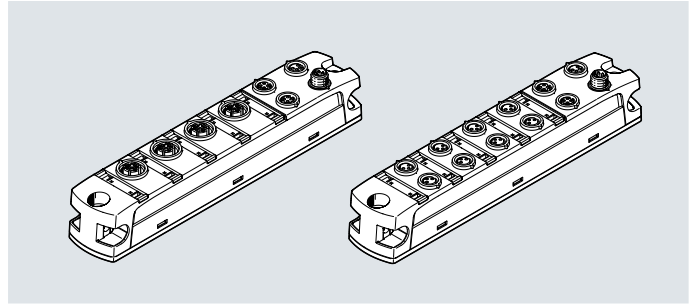

General technical data		CPX-AP-I-8DI-M8-3P	CPX-AP-I-8DI-M12-5P
Type			
Number of inputs		8	
Electrical connection, input			
Function		Digital input	
Connection type		8 x socket	4 x socket
Connection technology		M8x1, A-coded to EN 61076-2-104	M12x1, A-coded to EN 61076-2-101
Number of pins/wires		3	5
Switching logic at inputs		PNP (positive switching) 2-wire sensors to IEC 61131-2 3-wire sensors to IEC 61131-2	
Characteristic curve of inputs		To IEC 61131-2, type 3	
Switching level	[V]	Signal 0: ≤5	
	[V]	Signal 1: ≥11	
Fuse protection inputs (short circuit)		Internal electronic fuse per module	
Input debounce time	[ms]	0.1	
	[ms]	3	
	[ms]	10	
	[ms]	20	
Communication interface			
Protocol		AP	
Function		System communication XF10 IN / XF20 OUT	
Connection type		2 x socket	
Connection technology		M8x1, D-coded to EN 61076-2-114	
Number of pins/wires		4	
Screening		Yes	
General data			
Electrical isolation between channel and internal communication		Yes	
Electrical isolation between channels		No	
Diagnosics via LED		Diagnostics per module Status per channel	
Diagnosics via internal communication		Short circuit/overload in sensor supply Electronics/sensors overvoltage Electronics/sensors undervoltage	
Maximum cable length	[m]	30 inputs	
	[m]	50 system communication	
Information on maximum cable length		Power supply according to nominal voltage	
Reverse polarity protection		Yes	

Technical data – Digital 8-way input modules

Technical data – Electrical components		
Nominal operating voltage, electronics/sensors	[V DC]	24
Permissible voltage fluctuations for electronics/sensors	[%]	±25
Note on operating voltage		Note voltage drop SELV/PELV power supply units required
Power failure buffering	[ms]	10
Max. power supply	[A]	2x 4 External fuse required
Max. residual current of inputs per module	[A]	1.8
Intrinsic current consumption at nominal operating voltage for electronics/sensors	[mA]	Typically 32
Electrical connection, power supply		
Function		Incoming electronics/sensors and load
Connection type		Plug
Connection technology		M8x1, A-coded to EN 61076-2-104
Number of pins/wires		4
Electrical connection, power transmission		
Function		Outgoing electronics/sensors and load
Connection type		Socket
Connection technology		M8x1, A-coded to EN 61076-2-104
Number of pins/wires		4
Technical data – Mechanical components		
Type of mounting		Via through-hole On H-rail with accessories
Product weight	[g]	126
Dimensions W x L x H	[mm]	30 x 170 x 35
Tightening torque	[Nm]	1.2
Materials		
Housing		PA PC Nickel-plated, die-cast zinc
O-ring		FPM
Note on materials		RoHS-compliant
PWIS conformity		VDMA24364-B2-L
Operating and environmental conditions		
Ambient temperature	[°C]	-20 ... +50
Storage temperature	[°C]	-40 ... +70
Corrosion resistance class CRC ¹⁾		1
Relative humidity	[%]	5 ... 95 Non-condensing
CE marking (see declaration of conformity) ³⁾		To EU EMC Directive ²⁾
KC mark		KC EMC
UKCA marking (see declaration of conformity)		To UK instructions for EMC
Certification		RCM c UL us - Listed (OL)
Certificate-issuing authority		UL E239998
Degree of protection		IP65 IP67
Note on degree of protection		Unused connections sealed

1) Additional information: www.festo.com/x/topic/kbk2) For information about the area of use, see the EC declaration of conformity at: www.festo.com/catalogue/... → Support/Downloads.

If the devices are subject to usage restrictions in residential, commercial or light-industrial environments, further measures for the reduction of the emitted interference may be necessary.

3) Additional information: www.festo.com/catalogue/... → Support/Downloads.

Technical data – Digital 8-way input modules

Connection and display components

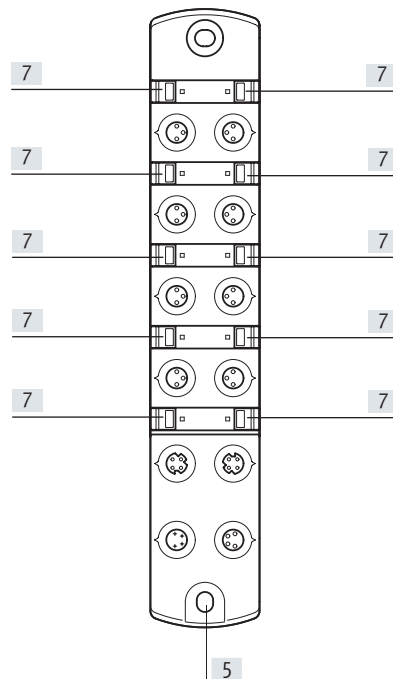
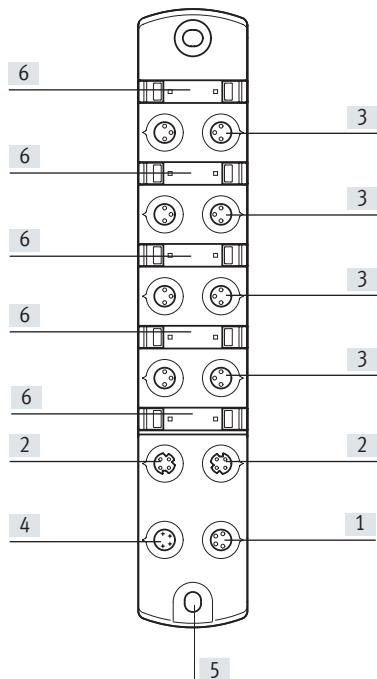

[1] Electrical connection, power transmission

[2] Communication interface

[3] Electrical connection, inputs

[4] Electrical connection, power supply

[5] Earthing connection

[6] Space for inscription label

[7] LED indicators

Technical data – Digital 8-way input modules

Dimensions

Download CAD data → www.festo.com

CPX-AP-I-8DI-M8-3P

CPX-AP-I-8DI-M12-5P

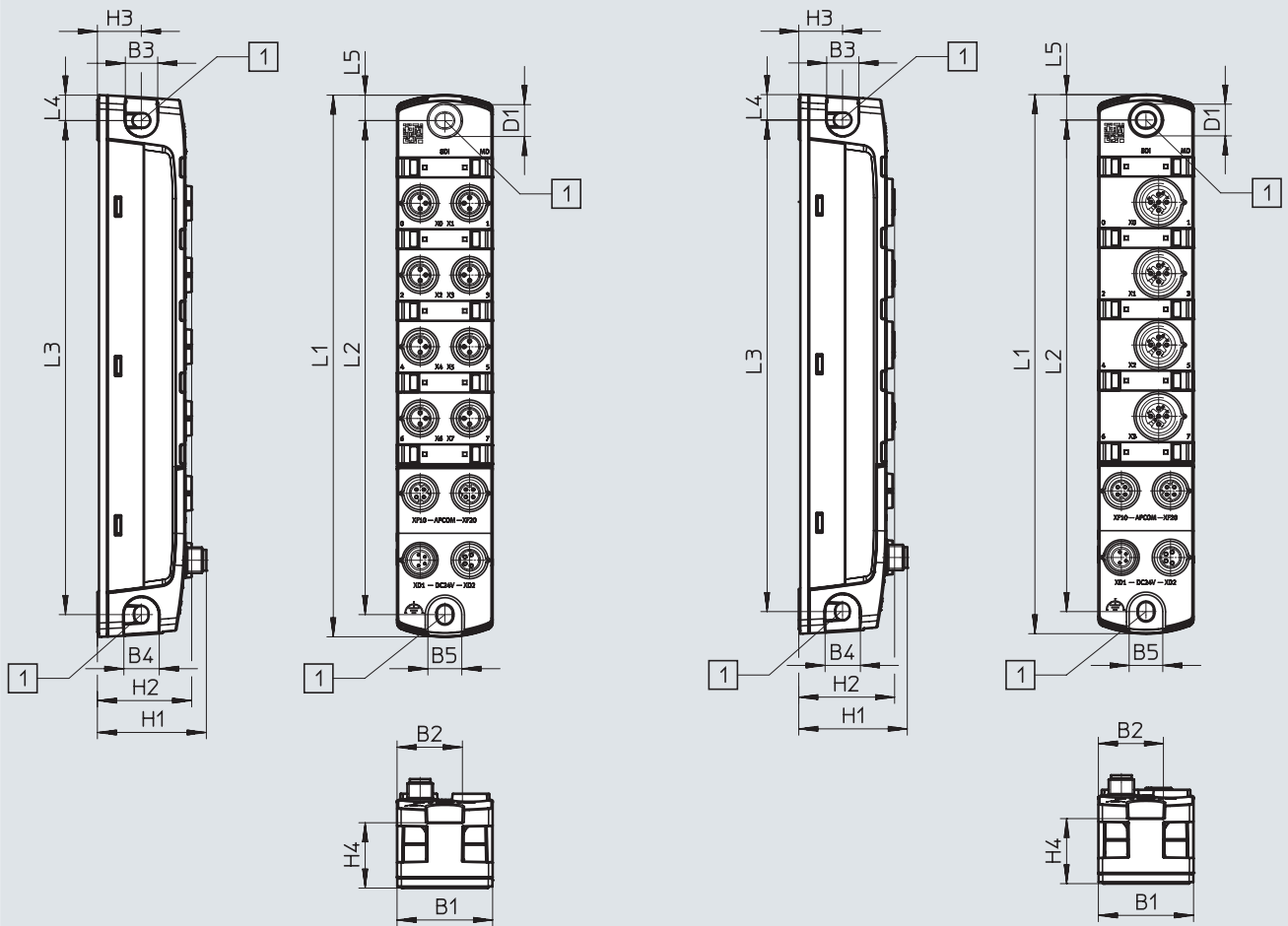

[1] Mounting hole for M4 screws

	B1	B2	B3	B4	B5	D1 ∅	H1	H2	H3	H4	L1	L2	L3	L4	L5
CPX-AP-I-8DI-M8-3P	30	20.5	10	11	11	10	34.2	29.6	13.8	20.5	170	155	155	8	8
CPX-AP-I-8DI-M12-5P	30	20.5	10	11	11	10	34.2	30.2	13.8	20.5	170	155	155	8	8

Technical data – Digital 8-way input modules

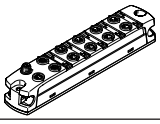
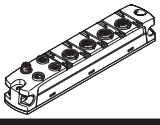
Ordering data		Part No.	Type
	Digital input module	Electrical connection input 8x socket, 3-pin, M8x1	8086600 CPX-AP-I-8DI-M8-3P
		Electrical connection input 4x socket, 5-pin, M12x1	8086602 CPX-AP-I-8DI-M12-5P

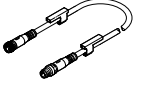
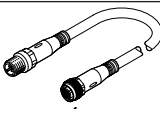
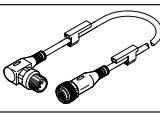
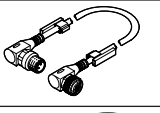
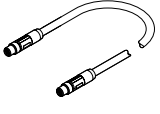

Ordering data – Accessories		Part No.	Type	
Description				
Pre-assembled plugs				
	For inputs	Straight plug, M8x1, 3-pin, A-coded	Screw terminal	192009 SEA-3GS-M8-S
			Solder connection	18696 SEA-GS-M8
		Straight plug, M12x1, 5-pin, A-coded	Screw terminal	175487 SEA-M12-5GS-PG7

Connecting cable						
	For inputs	Straight plug, M8x1, 3-pin, A-coded	Straight socket, M8 x 1, 3-pin, A-coded	0.5 m	541346	NEBU-M8G3-K-0.5-M8G3
				1.0 m	541347	NEBU-M8G3-K-1-M8G3
				1.5 m	8003133	NEBU-M8G3-K-1.5-M8G3
				2.0 m	8003131	NEBU-M8G3-K-2-M8G3
				2.5 m	541348	NEBU-M8G3-K-2.5-M8G3
				3.0 m	8003132	NEBU-M8G3-K-3-M8G3
				3.5 m	559364	NEBU-M8G3-E-3.5-M8G3
				5.0 m	541349	NEBU-M8G3-K-5-M8G3
				10.0 m	569844	NEBU-M8G3-K-10-M8G3
						Straight plug, M12x1, 5-pin, A-coded
5.0 m	574321	NEBU-M12G5-E-5-Q8N-M12G5				
7.5 m	574322	NEBU-M12G5-E-7.5-Q8N-M12G5				
		Angled plug, M12x1, 5-pin, A-coded	Straight socket, M12 x 1, 3-pin, A-coded	0.5 m	8003617	NEBU-M12G5-K-0.5-M12W5
				2.0 m	8003618	NEBU-M12G5-K-2-M12W5
			Angled socket, M12x1, 3-pin, A-coded	0.5 m	570733	NEBU-M12W5-K-0.5-M12W5
				2.0 m	570734	NEBU-M12W5-K-2-M12W5
	For communication interface	Straight plug, M8x1, 4-pin, D-coded	Straight plug, M8x1, 4-pin, D-coded	0.3 m	8082902	NEBC-D8G4-ES-0.3-N-S-D8G4-ET
				0.5 m	8065123	NEBC-D8G4-ES-0.5-N-S-D8G4-ET
				1.0 m	8065125	NEBC-D8G4-ES-1-N-S-D8G4-ET
				2.0 m	8065127	NEBC-D8G4-ES-2-N-S-D8G4-ET
				5.0 m	8065129	NEBC-D8G4-ES-5-N-S-D8G4-ET
				7.5 m	8065131	NEBC-D8G4-ES-7.5-N-S-D8G4-ET
				10.0 m	8065133	NEBC-D8G4-ES-10-N-S-D8G4-ET
				15.0 m	8065135	NEBC-D8G4-ES-15-N-S-D8G4-ET
				20.0 m	8146031	NEBC-D8G4-ES-20-N-S-D8G4-ET
				25.0 m	8146032	NEBC-D8G4-ES-25-N-S-D8G4-ET
				30.0 m	8146033	NEBC-D8G4-ES-30-N-S-D8G4-ET
				40.0 m	8146034	NEBC-D8G4-ES-40-N-S-D8G4-ET
50.0 m	8146035	NEBC-D8G4-ES-50-N-S-D8G4-ET				

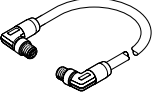
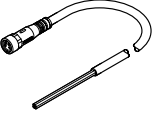
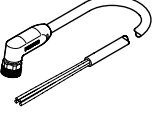
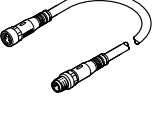
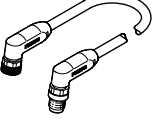
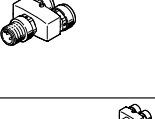
Technical data – Digital 8-way input modules

Ordering data – Accessories						
Description				Part No.	Type	
Connecting cable						
	For communication interface	Angled plug, M8x1, 4-pin, D-coded	Angled plug, M8x1, 4-pin, D-coded	0.5 m	8065124	NEBC-D8W4-ES-0.5-N-S-D8W4-ET
				1.0 m	8065126	NEBC-D8W4-ES-1-N-S-D8W4-ET
				2.0 m	8065128	NEBC-D8W4-ES-2-N-S-D8W4-ET
				5.0 m	8065130	NEBC-D8W4-ES-5-N-S-D8W4-ET
				7.5 m	8065132	NEBC-D8W4-ES-7.5-N-S-D8W4-ET
				10.0 m	8065134	NEBC-D8W4-ES-10-N-S-D8W4-ET
				15.0 m	8065136	NEBC-D8W4-ES-15-N-S-D8W4-ET
				20.0 m	8146036	NEBC-D8W4-ES-20-N-S-D8W4-ET
				25.0 m	8146037	NEBC-D8W4-ES-25-N-S-D8W4-ET
				30.0 m	8146038	NEBC-D8W4-ES-30-N-S-D8W4-ET
				40.0 m	8146039	NEBC-D8W4-ES-40-N-S-D8W4-ET
				50.0 m	8146040	NEBC-D8W4-ES-50-N-S-D8W4-ET
	For power supply	Straight socket, M8 x 1, 4-pin, A-coded	Open cable end, 4-wire	5.0 m	8065110	NEBL-M8G4-E-5-N-LE4
				7.5 m	8065113	NEBL-M8G4-E-7.5-N-LE4
				10.0 m	8065117	NEBL-M8G4-E-10-N-LE4
				15.0 m	8065121	NEBL-M8G4-E-15-N-LE4
		Angled socket, M8x1, 4-pin, A-coded	Open cable end, 4-wire	7.5 m	8065114	NEBL-M8W4-E-7.5-N-LE4
				10.0 m	8065118	NEBL-M8W4-E-10-N-LE4
				15.0 m	8065122	NEBL-M8W4-E-15-N-LE4
	For power transmission	Straight socket, M8 x 1, 4-pin, A-coded	Straight plug, M8 x 1, 4-pin, A-coded	0.3 m	8082904	NEBL-M8G4-E-0.3-N-M8G4
				0.5 m	8065102	NEBL-M8G4-E-0.5-N-M8G4
				1.0 m	8065104	NEBL-M8G4-E-1-N-M8G4
				2.0 m	8065106	NEBL-M8G4-E-2-N-M8G4
				5.0 m	8065108	NEBL-M8G4-E-5-N-M8G4
				7.5 m	8065111	NEBL-M8G4-E-7.5-N-M8G4
				10.0 m	8065115	NEBL-M8G4-E-10-N-M8G4
		Angled socket, M8x1, 4-pin, A-coded	Angled plug, M8x1, 4-pin, A-coded	0.3 m	8146577	NEBL-M8W4-E-0.3-N-M8W4
				0.5 m	8065103	NEBL-M8W4-E-0.5-N-M8W4
				1.0 m	8065105	NEBL-M8W4-E-1-N-M8W4
				2.0 m	8065107	NEBL-M8W4-E-2-N-M8W4
				5.0 m	8065109	NEBL-M8W4-E-5-N-M8W4
				7.5 m	8065112	NEBL-M8W4-E-7.5-N-M8W4
				10.0 m	8065116	NEBL-M8W4-E-10-N-M8W4
				15.0 m	8065120	NEBL-M8W4-E-15-N-M8W4
Distributor						
	For inputs	Straight plug, M12x1, 4-pin, A-coded	2x straight socket, M8x1, 3-pin, A-coded	–	8005311	NEDY-L2R1-V1-M8G3-N-M12G4
				–	8005310	NEDY-L2R1-V1-M12G5-N-M12G4
			2x straight socket, M12x1, 5-pin, A-coded	2.5 m	8005301	NEDY-L2R1-V1-M8G3-U-M12G4-2.5R
				5.0 m	8005302	NEDY-L2R1-V1-M8G3-U-M12G4-5R
			2x straight socket, M8x1, 3-pin, A-coded	0.3 m	8032309	NEDY-L2R1-V1-M8G3-U-0.3L-M12G4-2.5R
				2.5 m		
			2x straight socket, M12x1, 5-pin, A-coded	0.3 m	8035484	NEDY-L2R1-V1-M8G3-U-0.3L-M12G4-5R
				5.0 m		
			2x straight socket, M12x1, 5-pin, A-coded	2.5 m	8005305	NEDY-L2R1-V1-M12G5-U-M12G4-2.5R
				5.0 m	8005306	NEDY-L2R1-V1-M12G5-U-M12G4-5R
			2x straight socket, M12x1, 5-pin, A-coded	0.3 m	8035775	NEDY-L2R1-V1-M12G5-U-0.3L-M12G4-2.5R
				2.5 m		
2x straight socket, M12x1, 5-pin, A-coded	0.3 m	8035776	NEDY-L2R1-V1-M12G5-U-0.3L-M12G4-5R			
	5.0 m					

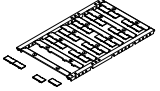
Technical data – Digital 8-way input modules

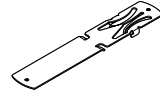
Ordering data – Accessories					
	Description	Pack size	Part No.	Type	
Inscription label					
	For modules CPX-AP-I Size 6x 12.5 mm, 10 frames with 24 pieces each	240	8087174	ASLR-L-X4-612-P240	
Cover cap					
	For sealing unused connections	For connection M8x1	10	177672	ISK-M8
		For connection M12x1	10	165592	ISK-M12
H-rail mounting					
	For mounting a module on H-rails to EN 60715	–	8095158	CAFM-X4-H	

Technical data – Analogue input modules

Function

Analogue input modules make it possible to detect 4 analogue input signals. All 4 channels can be set separately to measure current, voltage, temperature or resistance.

- Input modules for 24 V DC operating voltage
- Connection M12x1, 5-pin
- Status and error indication via LED

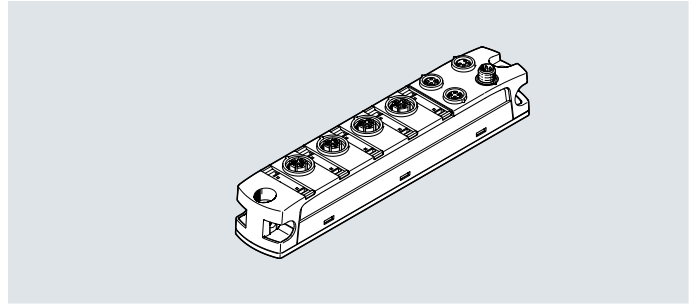

General technical data	
Number of inputs	4
Electrical connection, input	
Function	Analogue input
Connection type	4 x socket
Connection technology	M12x1, A-coded to EN 61076-2-101
Note on connection technology	To achieve the technical specifications, the opposite side must be shielded and designed with gold contact surfaces.
Number of pins/wires	5
Fuse protection inputs (short circuit)	Internal electronic fuse per module
Signal range	[V] 1 ... 5
	[V] -5 ... 5
	[V] 0 ... 10
	[V] -10 ... 10
	[mA] 0 ... 20
	[mA] 4 ... 20
	[ohm] 0 ... 500
Data format	15 bits + prefix
	Linear scaling
Measured variable	Voltage
	Current
	Resistance
	Temperature
Repetition accuracy	[%] ± 0.025 at 25°C
Operating error limit related to the ambient temperature range	[%] ± 0.15 for voltage
	[%] ± 0.15 for current
	[%] ± 0.35 for resistance
	[%] ± 0.9 for temperature
Basic error limit at 25°C	[%] ± 0.1 for voltage
	[%] ± 0.1 for current
	[%] ± 0.2 for resistance
	[%] ± 0.4 for temperature
Communication interface	
Protocol	AP
Function	System communication XF10 IN / XF20 OUT
Connection type	2 x socket
Connection technology	M8x1, D-coded to EN 61076-2-114
Number of pins/wires	4
Screening	Yes

Technical data – Analogue input modules

General data		
Electrical isolation between channel and internal communication		Yes
Electrical isolation between channels		No
Diagnostics via LED		Diagnostics per module Status per channel
Diagnostics via internal communication		Short circuit/overload in sensor supply Wire break Module error Parameter error Parameterisation error Overload at analogue inputs Upper limit value not observed Underflow/overflow Lower limit value not observed
Maximum cable length	[m]	30 inputs
	[m]	50 system communication
Reverse polarity protection		Yes
Technical data – Electrical components		
Nominal operating voltage, electronics/sensors	[V DC]	24
Permissible voltage fluctuations for electronics/sensors	[%]	±25
Note on operating voltage		Note voltage drop SELV/PELV power supply units required
Power failure buffering	[ms]	10
Max. power supply	[A]	2x 4 External fuse required
Max. residual current of inputs per module	[A]	1
Intrinsic current consumption at nominal operating voltage for electronics/sensors	[mA]	Typically 38
Electrical connection, power supply		
Function		Incoming electronics/sensors and load
Connection type		Plug
Connection technology		M8x1, A-coded to EN 61076-2-104
Number of pins/wires		4
Electrical connection, power transmission		
Function		Outgoing electronics/sensors and load
Connection type		Socket
Connection technology		M8x1, A-coded to EN 61076-2-104
Number of pins/wires		4
Technical data – Mechanical components		
Type of mounting		Via through-hole On H-rail with accessories
Product weight	[g]	166
Dimensions W x L x H	[mm]	30 x 170 x 35
Materials		
Housing		PA PC Nickel-plated, die-cast zinc
Seals		NBR
O-ring		FPM
Note on materials		RoHS-compliant
PWIS conformity		VDMA24364-B2-L

Technical data – Analogue input modules

Operating and environmental conditions		
Ambient temperature	[°C]	-20 ... +50
Storage temperature	[°C]	-40 ... +70
Corrosion resistance class CRC ¹⁾		1
Relative humidity	[%]	5 ... 95
		Non-condensing
CE marking (see declaration of conformity ³⁾)		To EU EMC Directive ²⁾
KC mark		KC EMC
UKCA marking (see declaration of conformity)		To UK instructions for EMC
Certification		RCM
		c UL us - Listed (OL)
Certificate-issuing authority		UL E239998
Degree of protection		IP65
		IP67
Note on degree of protection		Unused connections sealed

1) Additional information: www.festo.com/x/topic/kbk

2) For information about the area of use, see the EC declaration of conformity at: www.festo.com/catalogue/... → Support/Downloads.

If the devices are subject to usage restrictions in residential, commercial or light-industrial environments, further measures for the reduction of the emitted interference may be necessary.

3) Additional information: www.festo.com/catalogue/... → Support/Downloads.

Connection and display components

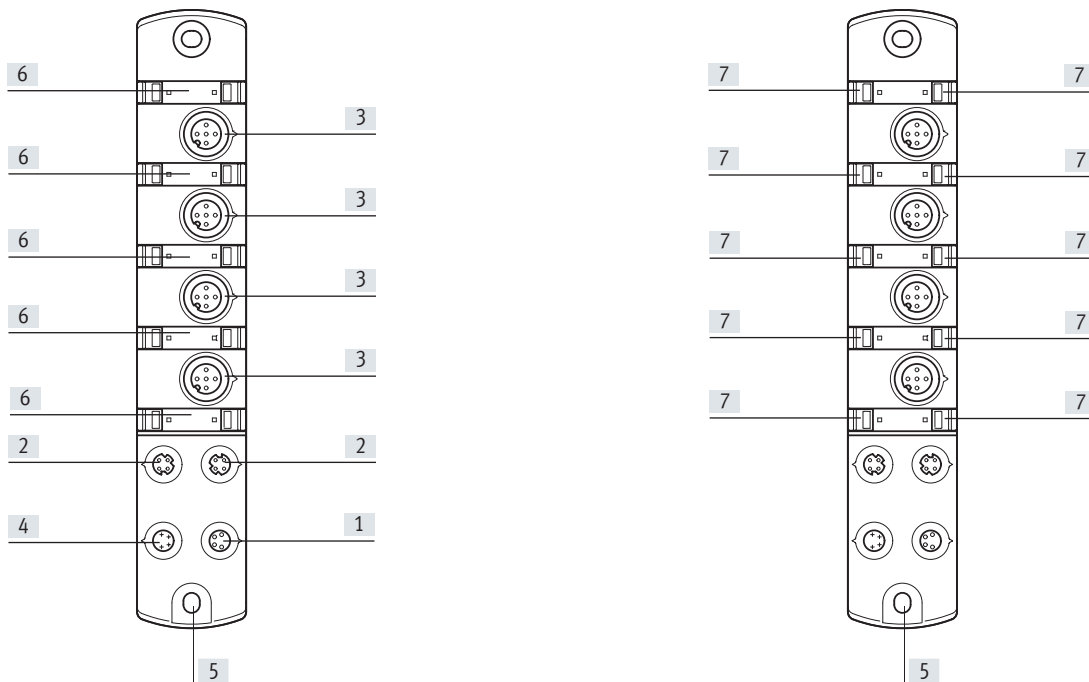

[1] Electrical connection, power transmission

[2] Communication interface

[3] Electrical connection, inputs

[4] Electrical connection, power supply

[5] Earthing connection

[6] Space for inscription label

[7] LED indicators

Technical data – Analogue input modules

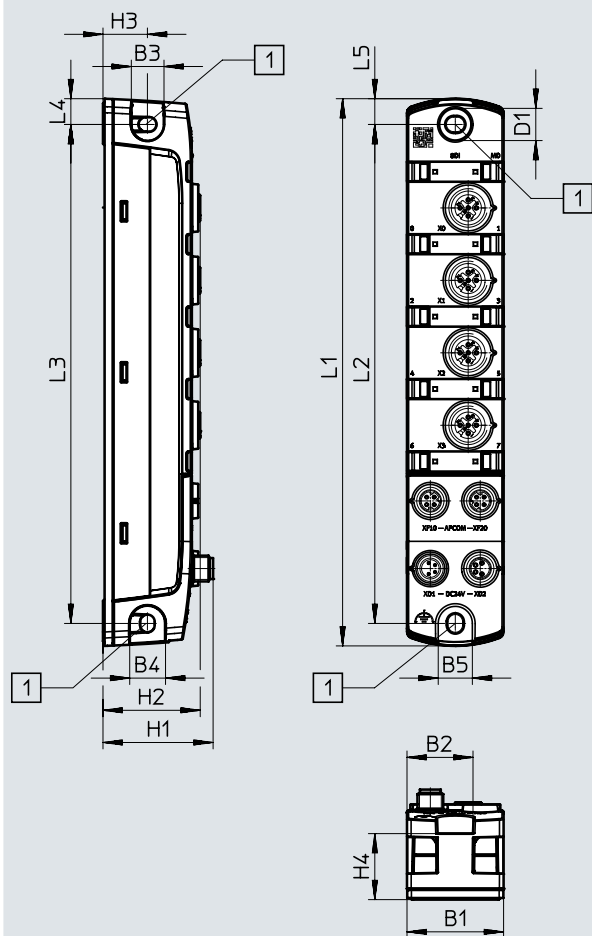

Dimensions

Download CAD data → www.festo.com

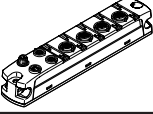
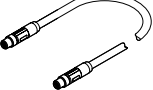

[1] Mounting hole for M4 screws

	B1	B2	B3	B4	B5	D1 ∅	H1	H2	H3	H4	L1	L2	L3	L4	L5
CPX-AP-I-4AI-U-I-RTD-M12	30	20.5	10	11	11	10	34.2	30.2	13.8	20.5	170	155	155	8	8

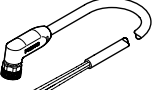
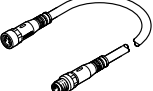
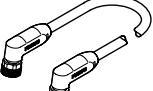
Technical data – Analogue input modules

Ordering data				Part No.	Type	
	Analogue input module	Electrical connection input 4x socket, 5-pin, M12x1		8086606	CPX-AP-I-4AI-U-I-RTD-M12	
Ordering data – Accessories						
Description				Part No.	Type	
Connecting cable						
	For communication interface	Straight plug, M8x1, 4-pin, D-coded	Straight plug, M8x1, 4-pin, D-coded	0.3 m	8082902	NEBC-D8G4-ES-0.3-N-S-D8G4-ET
				0.5 m	8065123	NEBC-D8G4-ES-0.5-N-S-D8G4-ET
				1.0 m	8065125	NEBC-D8G4-ES-1-N-S-D8G4-ET
				2.0 m	8065127	NEBC-D8G4-ES-2-N-S-D8G4-ET
				5.0 m	8065129	NEBC-D8G4-ES-5-N-S-D8G4-ET
				7.5 m	8065131	NEBC-D8G4-ES-7.5-N-S-D8G4-ET
				10.0 m	8065133	NEBC-D8G4-ES-10-N-S-D8G4-ET
				15.0 m	8065135	NEBC-D8G4-ES-15-N-S-D8G4-ET
				20.0 m	8146031	NEBC-D8G4-ES-20-N-S-D8G4-ET
				25.0 m	8146032	NEBC-D8G4-ES-25-N-S-D8G4-ET
				30.0 m	8146033	NEBC-D8G4-ES-30-N-S-D8G4-ET
				40.0 m	8146034	NEBC-D8G4-ES-40-N-S-D8G4-ET
				50.0 m	8146035	NEBC-D8G4-ES-50-N-S-D8G4-ET
		Angled plug, M8x1, 4-pin, D-coded	Angled plug, M8x1, 4-pin, D-coded	0.5 m	8065124	NEBC-D8W4-ES-0.5-N-S-D8W4-ET
				1.0 m	8065126	NEBC-D8W4-ES-1-N-S-D8W4-ET
				2.0 m	8065128	NEBC-D8W4-ES-2-N-S-D8W4-ET
				5.0 m	8065130	NEBC-D8W4-ES-5-N-S-D8W4-ET
				7.5 m	8065132	NEBC-D8W4-ES-7.5-N-S-D8W4-ET
				10.0 m	8065134	NEBC-D8W4-ES-10-N-S-D8W4-ET
				15.0 m	8065136	NEBC-D8W4-ES-15-N-S-D8W4-ET
				20.0 m	8146036	NEBC-D8W4-ES-20-N-S-D8W4-ET
				25.0 m	8146037	NEBC-D8W4-ES-25-N-S-D8W4-ET
				30.0 m	8146038	NEBC-D8W4-ES-30-N-S-D8W4-ET
				40.0 m	8146039	NEBC-D8W4-ES-40-N-S-D8W4-ET
				50.0 m	8146040	NEBC-D8W4-ES-50-N-S-D8W4-ET
					For power supply	Straight socket, M8 x 1, 4-pin, A-coded
7.5 m	8065113	NEBL-M8G4-E-7.5-N-LE4				
10.0 m	8065117	NEBL-M8G4-E-10-N-LE4				
15.0 m	8065121	NEBL-M8G4-E-15-N-LE4				
		Angled socket, M8x1, 4-pin, A-coded	Open cable end, 4-wire	7.5 m	8065114	NEBL-M8W4-E-7.5-N-LE4
				10.0 m	8065118	NEBL-M8W4-E-10-N-LE4
				15.0 m	8065122	NEBL-M8W4-E-15-N-LE4
	For power transmission	Straight socket, M8 x 1, 4-pin, A-coded	Straight plug, M8 x 1, 4-pin, A-coded	0.3 m	8082904	NEBL-M8G4-E-0.3-N-M8G4
				0.5 m	8065102	NEBL-M8G4-E-0.5-N-M8G4
				1.0 m	8065104	NEBL-M8G4-E-1-N-M8G4
				2.0 m	8065106	NEBL-M8G4-E-2-N-M8G4
				5.0 m	8065108	NEBL-M8G4-E-5-N-M8G4
				7.5 m	8065111	NEBL-M8G4-E-7.5-N-M8G4
				10.0 m	8065115	NEBL-M8G4-E-10-N-M8G4
				15.0 m	8065119	NEBL-M8G4-E-15-N-M8G4
		Angled socket, M8x1, 4-pin, A-coded	Angled plug, M8x1, 4-pin, A-coded	0.3 m	8146577	NEBL-M8W4-E-0.3-N-M8W4
				0.5 m	8065103	NEBL-M8W4-E-0.5-N-M8W4
				1.0 m	8065105	NEBL-M8W4-E-1-N-M8W4
				2.0 m	8065107	NEBL-M8W4-E-2-N-M8W4
				5.0 m	8065109	NEBL-M8W4-E-5-N-M8W4
				7.5 m	8065112	NEBL-M8W4-E-7.5-N-M8W4
				10.0 m	8065116	NEBL-M8W4-E-10-N-M8W4
				15.0 m	8065120	NEBL-M8W4-E-15-N-M8W4

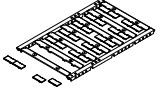
Technical data – Analogue input modules

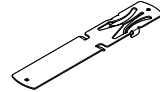
Ordering data – Accessories					
	Description	Pack size	Part No.	Type	
Inscription label					
	For modules CPX-AP-I Size 6x 12.5 mm, 10 frames with 24 pieces each	240	8087174	ASLR-L-X4-612-P240	
Cover cap					
	For sealing unused connections	For connection M8x1	10	177672	ISK-M8
		For connection M12x1	10	165592	ISK-M12
H-rail mounting					
	For mounting a module on H-rails to EN 60715	–	8095158	CAFM-X4-H	

Technical data – Digital input/output modules

Function

Digital input/output modules facilitate the connection of electric sensors to IEC 61131-2 type 3 (inductive, capacitive) and of electrical consumers to IEC 1131-2 type 0.5 with an operating voltage of 24 V DC.

- Input/output modules for 24 V DC operating voltage
- Connection M8x1 3-pin or M12x1 5-pin
- Status and error indication via LED

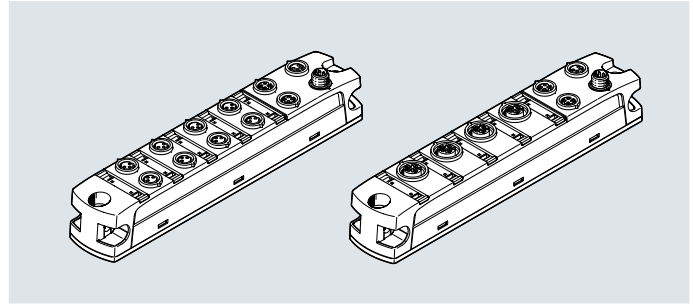

General technical data		CPX-AP-I-4DI4DO-M8-3P	CPX-AP-I-4DI4DO-M12-5P
Type		CPX-AP-I-4DI4DO-M8-3P	CPX-AP-I-4DI4DO-M12-5P
Number of inputs		4	
Number of outputs		4	
Electrical connection, input			
Function		Digital input	
Connection type		4 x socket	2 x socket
Connection technology		M8x1, A-coded to EN 61076-2-104	M12x1, A-coded to EN 61076-2-101
Number of pins/wires		3	5
Switching logic at inputs		PNP (positive switching)	
		2-wire sensors to IEC 61131-2	
		3-wire sensors to IEC 61131-2	
Characteristic curve of inputs		To IEC 61131-2, type 3	
Switching level	[V]	Signal 0: ≤5	
	[V]	Signal 1: ≥11	
Fuse protection inputs (short circuit)		Internal electronic fuse per module	
Input debounce time	[ms]	0.1	
	[ms]	3	
	[ms]	10	
	[ms]	20	
Electrical isolation of inputs between channel and internal communication		Yes	
Electrical isolation of inputs between channels		No	
Electrical connection, output			
Function		Digital output	
Connection type		4 x socket	2 x socket
Connection technology		M8x1, A-coded to EN 61076-2-104	M12x1, A-coded to EN 61076-2-101
Number of pins/wires		3	5
Switching logic at outputs		PNP (positive switching)	
Characteristic curve of outputs		To IEC 61131-2, type 0.5	
Output delay with resistive load	[μs]	Signal change from 0 to 1: <200	
	[μs]	Signal change from 1 to 0: <200	
Fuse protection outputs (short circuit)		Internal electronic fuse per channel	
Electrical isolation of outputs between channel and internal communication		Yes	
Electrical isolation of outputs between channels		No	
Communication interface			
Protocol		AP	
Function		System communication XF10 IN / XF20 OUT	
Connection type		2 x socket	
Connection technology		M8x1, D-coded to EN 61076-2-114	
Number of pins/wires		4	
Screening		Yes	

Technical data – Digital input/output modules

General data		
Diagnostics via LED		Diagnostics per module
		Status per channel
		Power supply load
Diagnostics via internal communication		Load overvoltage
		Load undervoltage
		Load switch-off
		Short-circuit/overload output signal
		Electronics/sensors overvoltage
		Electronics/sensors undervoltage
Maximum cable length	[m]	30 outputs
	[m]	30 inputs
	[m]	50 system communication
Information on maximum cable length		Power supply according to nominal voltage
Reverse polarity protection		Yes

Technical data – Electrical components		
Nominal operating voltage, electronics/sensors	[V DC]	24
Nominal operating voltage, load	[V DC]	24
Permissible voltage fluctuations for electronics/sensors	[%]	±25
Permissible voltage fluctuations, load	[%]	±25
Note on operating voltage		Note voltage drop
		SELV/PELV power supply units required
Power failure buffering	[ms]	10
Max. power supply	[A]	2x 4
		External fuse required
Max. power supply per channel	[A]	0.5
Max. residual current of inputs per module	[A]	1.8
Max. total current of outputs per module	[A]	2
Intrinsic current consumption at nominal operating voltage for electronics/sensors	[mA]	Typically 35
Intrinsic current consumption at nominal operating voltage, load	[mA]	Typically 10
Electrical connection, power supply		
Function		Incoming electronics/sensors and load
Connection type		Plug
Connection technology		M8x1, A-coded to EN 61076-2-104
Number of pins/wires		4
Electrical connection, power transmission		
Function		Outgoing electronics/sensors and load
Connection type		Socket
Connection technology		M8x1, A-coded to EN 61076-2-104
Number of pins/wires		4

Technical data – Mechanical components		
Type of mounting		Via through-hole
		On H-rail with accessories
Product weight	[g]	129
Dimensions W x L x H	[mm]	30 x 170 x 35
Tightening torque	[Nm]	1.2

Materials		
Housing		PA
		PC
		Nickel-plated, die-cast zinc
O-ring		FPM
Note on materials		RoHS-compliant
PWIS conformity		VDMA24364-B2-L

Technical data – Digital input/output modules

Operating and environmental conditions		
Ambient temperature	[°C]	-20 ... +50
Storage temperature	[°C]	-40 ... +70
Corrosion resistance class CRC ¹⁾		1
Relative humidity	[%]	5 ... 95
		Non-condensing
CE marking (see declaration of conformity) ³⁾		To EU EMC Directive ²⁾
KC mark		KC EMC
UKCA marking (see declaration of conformity)		To UK instructions for EMC
Certification		RCM
		c UL us - Listed (OL)
Certificate-issuing authority		UL E239998
Degree of protection		IP65
		IP67
Note on degree of protection		Unused connections sealed

1) Additional information: www.festo.com/x/topic/kbk

2) For information about the area of use, see the EC declaration of conformity at: www.festo.com/catalogue/... → Support/Downloads.

If the devices are subject to usage restrictions in residential, commercial or light-industrial environments, further measures for the reduction of the emitted interference may be necessary.

3) Additional information: www.festo.com/catalogue/... → Support/Downloads.

Connection and display components

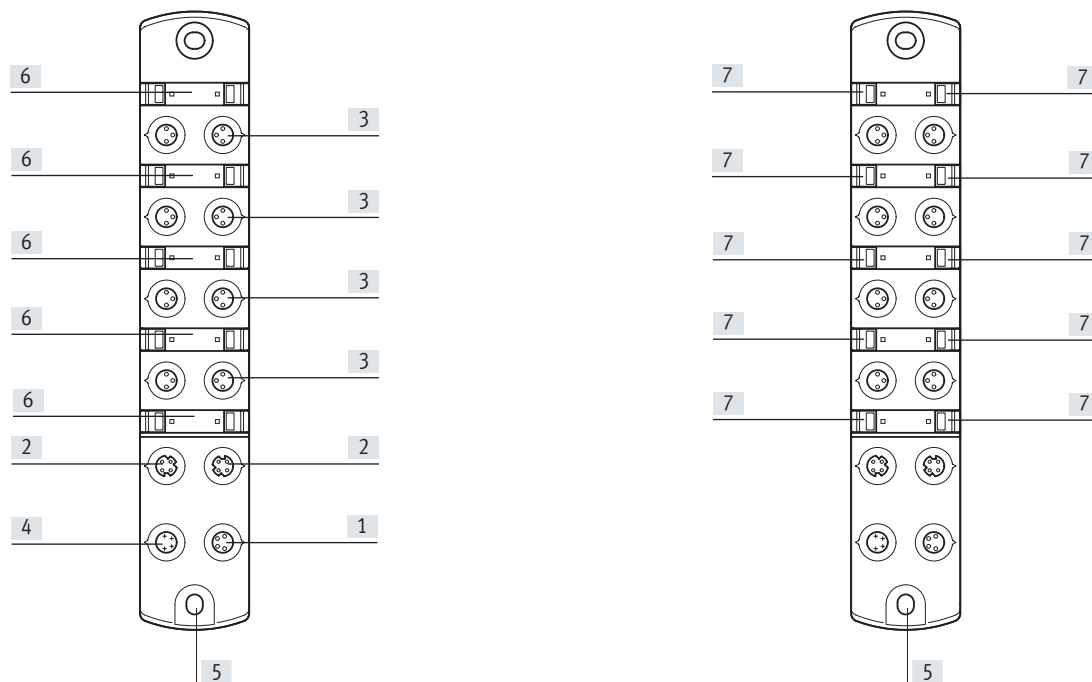

[1] Electrical connection, power transmission

[2] Communication interface

[3] Electrical connection, inputs/outputs

[4] Electrical connection, power supply

[5] Earthing connection

[6] Space for inscription label

[7] LED indicators

Technical data – Digital input/output modules

Dimensions

Download CAD data → www.festo.com

CPX-AP-I-4DI4DO-M8-3P

CPX-AP-I-4DI4DO-M12-5P

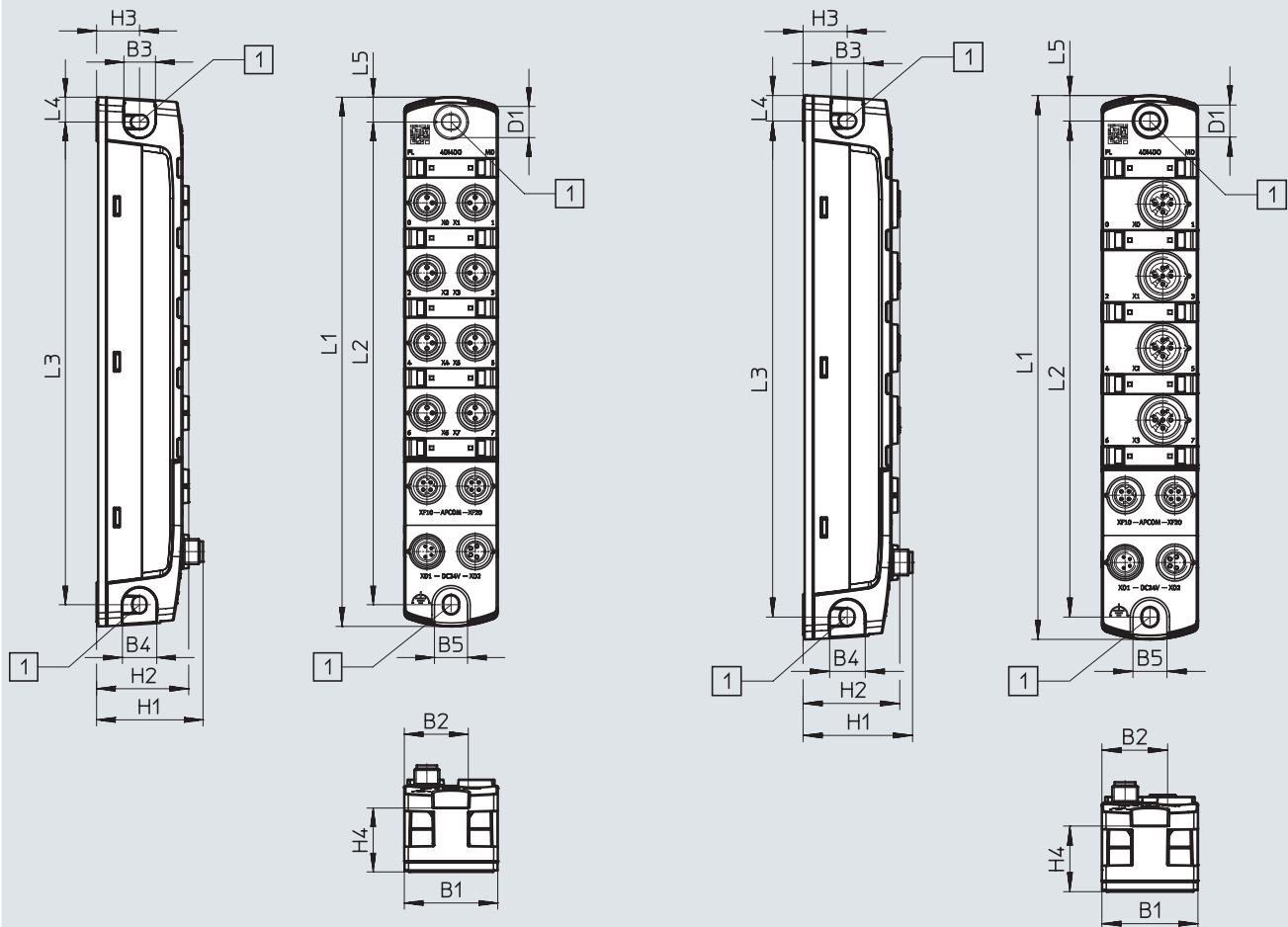



[1] Mounting hole for M4 screws

	B1	B2	B3	B4	B5	D1 ∅	H1	H2	H3	H4	L1	L2	L3	L4	L5
CPX-AP-I-4DI4DO-M8-3P	30	20.5	10	11	11	10	34.2	29.6	13.8	20.5	170	155	155	8	8
CPX-AP-I-4DI4DO-M12-5P	30	20.5	10	11	11	10	34.2	30.2	13.8	20.5	170	155	155	8	8

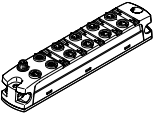
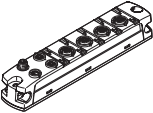

Technical data – Digital input/output modules

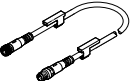
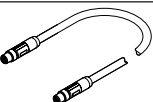
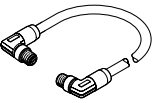
Ordering data		Part No.	Type
	Digital input/output module	<ul style="list-style-type: none"> Electrical connection input 4x socket, 3-pin, M8x1 Electrical connection output 4x socket, 3-pin, M8x1 	8086601 CPX-AP-I-4DI4DO-M8-3P
		<ul style="list-style-type: none"> Electrical connection input 2x socket, 5-pin, M12x1 Electrical connection output 2x socket, 5-pin, M12x1 	8086603 CPX-AP-I-4DI4DO-M12-5P

Ordering data – Accessories					
Description				Part No.	Type
Pre-assembled plugs					
	For inputs	Straight plug, M8x1, 3-pin, A-coded	Screw terminal	192009	SEA-3GS-M8-S
			Solder connection	18696	SEA-GS-M8
		Straight plug, M12x1, 5-pin, A-coded	Screw terminal	175487	SEA-M12-5GS-PG7
Distributor					
	For inputs	Straight plug, M8x1, 4-pin, A-coded	2x straight socket, M8x1, 3-pin, A-coded	8005312	NEDY-L2R1-V1-M8G3-N-M8G4
Connecting cable					
	For inputs	Straight plug, M8x1, 3-pin, A-coded	Straight socket, M8 x 1, 3-pin, A-coded	0.5 m	541346 NEBU-M8G3-K-0.5-M8G3
				1.0 m	541347 NEBU-M8G3-K-1-M8G3
				1.5 m	8003133 NEBU-M8G3-K-1.5-M8G3
				2.0 m	8003131 NEBU-M8G3-K-2-M8G3
				2.5 m	541348 NEBU-M8G3-K-2.5-M8G3
				3.0 m	8003132 NEBU-M8G3-K-3-M8G3
				3.5 m	559364 NEBU-M8G3-E-3.5-M8G3
				5.0 m	541349 NEBU-M8G3-K-5-M8G3
				10.0 m	569844 NEBU-M8G3-K-10-M8G3
	For communication interface	Straight plug, M8x1, 4-pin, D-coded	Straight plug, M8x1, 4-pin, D-coded	0.3 m	8082902 NEBC-D8G4-ES-0.3-N-S-D8G4-ET
				0.5 m	8065123 NEBC-D8G4-ES-0.5-N-S-D8G4-ET
				1.0 m	8065125 NEBC-D8G4-ES-1-N-S-D8G4-ET
				2.0 m	8065127 NEBC-D8G4-ES-2-N-S-D8G4-ET
				5.0 m	8065129 NEBC-D8G4-ES-5-N-S-D8G4-ET
				7.5 m	8065131 NEBC-D8G4-ES-7.5-N-S-D8G4-ET
				10.0 m	8065133 NEBC-D8G4-ES-10-N-S-D8G4-ET
				15.0 m	8065135 NEBC-D8G4-ES-15-N-S-D8G4-ET
				20.0 m	8146031 NEBC-D8G4-ES-20-N-S-D8G4-ET
				25.0 m	8146032 NEBC-D8G4-ES-25-N-S-D8G4-ET
				30.0 m	8146033 NEBC-D8G4-ES-30-N-S-D8G4-ET
				40.0 m	8146034 NEBC-D8G4-ES-40-N-S-D8G4-ET
				50.0 m	8146035 NEBC-D8G4-ES-50-N-S-D8G4-ET
					
1.0 m	8065126 NEBC-D8W4-ES-1-N-S-D8W4-ET				
2.0 m	8065128 NEBC-D8W4-ES-2-N-S-D8W4-ET				
5.0 m	8065130 NEBC-D8W4-ES-5-N-S-D8W4-ET				
7.5 m	8065132 NEBC-D8W4-ES-7.5-N-S-D8W4-ET				
10.0 m	8065134 NEBC-D8W4-ES-10-N-S-D8W4-ET				
15.0 m	8065136 NEBC-D8W4-ES-15-N-S-D8W4-ET				
20.0 m	8146036 NEBC-D8W4-ES-20-N-S-D8W4-ET				
25.0 m	8146037 NEBC-D8W4-ES-25-N-S-D8W4-ET				
30.0 m	8146038 NEBC-D8W4-ES-30-N-S-D8W4-ET				
40.0 m	8146039 NEBC-D8W4-ES-40-N-S-D8W4-ET				
50.0 m	8146040 NEBC-D8W4-ES-50-N-S-D8W4-ET				

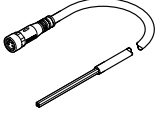
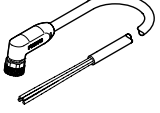
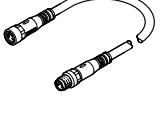
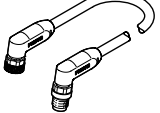
Technical data – Digital input/output modules

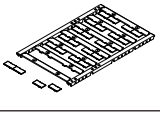
Ordering data – Accessories						
Description		Part No.	Type			
Connecting cable						
	For power supply	Straight socket, M8 x 1, 4-pin, A-coded	Open cable end, 4-wire	5.0 m	8065110	NEBL-M8G4-E-5-N-LE4
				7.5 m	8065113	NEBL-M8G4-E-7.5-N-LE4
				10.0 m	8065117	NEBL-M8G4-E-10-N-LE4
				15.0 m	8065121	NEBL-M8G4-E-15-N-LE4
		Angled socket, M8x1, 4-pin, A-coded	Open cable end, 4-wire	7.5 m	8065114	NEBL-M8W4-E-7.5-N-LE4
				10.0 m	8065118	NEBL-M8W4-E-10-N-LE4
				15.0 m	8065122	NEBL-M8W4-E-15-N-LE4
	For power transmission	Straight socket, M8 x 1, 4-pin, A-coded	Straight plug, M8 x 1, 4-pin, A-coded	0.3 m	8082904	NEBL-M8G4-E-0.3-N-M8G4
				0.5 m	8065102	NEBL-M8G4-E-0.5-N-M8G4
				1.0 m	8065104	NEBL-M8G4-E-1-N-M8G4
				2.0 m	8065106	NEBL-M8G4-E-2-N-M8G4
				5.0 m	8065108	NEBL-M8G4-E-5-N-M8G4
				7.5 m	8065111	NEBL-M8G4-E-7.5-N-M8G4
				10.0 m	8065115	NEBL-M8G4-E-10-N-M8G4
				15.0 m	8065119	NEBL-M8G4-E-15-N-M8G4
		Angled socket, M8x1, 4-pin, A-coded	Angled plug, M8x1, 4-pin, A-coded	0.3 m	8146577	NEBL-M8W4-E-0.3-N-M8W4
				0.5 m	8065103	NEBL-M8W4-E-0.5-N-M8W4
				1.0 m	8065105	NEBL-M8W4-E-1-N-M8W4
				2.0 m	8065107	NEBL-M8W4-E-2-N-M8W4
				5.0 m	8065109	NEBL-M8W4-E-5-N-M8W4
				7.5 m	8065112	NEBL-M8W4-E-7.5-N-M8W4
				10.0 m	8065116	NEBL-M8W4-E-10-N-M8W4
				15.0 m	8065120	NEBL-M8W4-E-15-N-M8W4

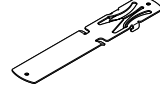
Ordering data – Accessories					
Description		Pack size	Part No.	Type	
Inscription label					
	For modules CPX-AP-I Size 6x 12.5 mm, 10 frames with 24 pieces each	240	8087174	ASLR-L-X4-612-P240	
Cover cap					
	For sealing unused connections	For connection M8x1	10	177672	ISK-M8
		For connection M12x1	10	165592	ISK-M12
H-rail mounting					
	For mounting a module on H-rails to EN 60715	–	8095158	CAFM-X4-H	

Technical data – Manifold sub-base for valve terminal VTUX

Function

The manifold sub-base for VTUX facilitates a valve terminal VTUX to be operated as a component of the automation system CPX-AP-I.

- Display of power supply and module diagnostics via LED indicators
- Up to 32 valve positions with up to 32 solenoid coils
- Short-circuit shutdown, short-circuit diagnostics and switching cycle counter

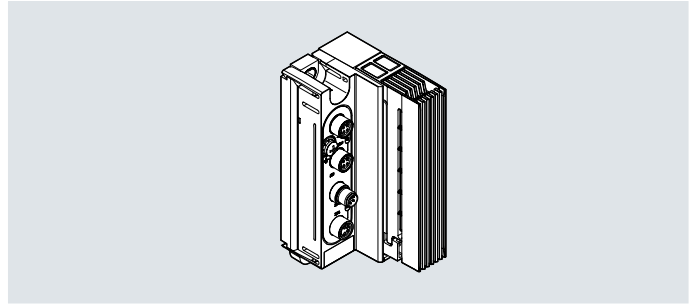

General technical data

Valve terminal design	Valve sizes can be mixed
Max. address volume for outputs [byte]	4
Maximum number of valve positions	32
Max. no. of solenoid coils	32
Communication interface	
Protocol	AP-COM
Function	System communication XF10 IN / XF20 OUT
Connection type	2 x socket
Connection technology	M8x1, D-coded to EN 61076-2-114
Number of pins/wires	4
Shielding	Yes

General data

Module parameters	Configuration of voltage monitoring load supply PL
	Response in error state
Diagnostics via LED	Diagnostics per module
	Power supply load
Communication	Electronics/sensors overvoltage
Diagnostics via internal communication	Electronics/sensors undervoltage
	Load switch-off
Undervoltage load/valves (diagnostic message) [V]	≤21.1
Maximum cable length [m]	50 system communication

Technical data – Manifold sub-base for valve terminal VTUX

Technical data – Electrical components		
Nominal operating voltage, electronics/sensors	[V DC]	24
Permissible voltage fluctuations, electronics/sensors	[%]	±25
Nominal operating voltage, load	[V DC]	24
Permissible voltage fluctuations, load	[%]	±10
Note on the operating voltage		SELV/PELV power supply units required Note voltage drop
Power failure buffering	[ms]	10
Maximum power supply		2 x 4 A (external fuse required)
Fuse protection (short circuit)		Internal electronic fuse per channel
Inductive protective circuit		Integrated
Overvoltage category		II
Protection against direct and indirect contact		PELV SELV
Reverse polarity protection		Yes
Intrinsic current consumption at nominal operating voltage, electronics/sensors	[mA]	Typically 27
Intrinsic current consumption at nominal operating voltage, load	[mA]	Typically 13
Power consumption at 24 V DC	[mW]	650
Pollution degree		2
Electrical isolation of outputs between channel - internal communication		Yes
Electrical connection, power supply		
Function		Incoming electronics/sensors and load
Connection technology		M8x1, A-coded to EN 61076-2-104
Number of pins/wires		4
Electrical connection, power transmission		
Function		Outgoing electronics/sensors and load
Connection type		Socket
Connection technology		M8x1, A-coded to EN 61076-2-104
Number of pins/wires		4

Technical data – Manifold sub-base for valve terminal VTUX

Technical data – Mechanical components		
Type of mounting		Tie rods
Type of mounting sub-base		Via through-hole
Connection position		On the side
Product weight	[g]	144.8
Dimensions W x L x H	[mm]	45 x 104.3 x 55.3
Max. tightening torque for wall mounting	[Nm]	6

Materials		
Connecting plate		Reinforced PA
Cover		Reinforced PA
Film		Polyester
Sleeve		High-alloy stainless steel
Clamp		High-alloy stainless steel
Nut		High-alloy stainless steel
Seals		NBR
Note on materials		RoHS-compliant
LABS (PWIS) conformity		VDMA24364-B1/B2-L

Operating and environmental conditions		
Ambient temperature	[°C]	-20 ... +50
Storage temperature	[°C]	-20 ... +70
Corrosion resistance class CRC ¹⁾		2
Relative humidity	[%]	5 ... 95
Nominal operating altitude		< 3000 m above sea level
Vibration resistant		Transport application test with severity level 2 to FN 942017-4 and EN 60068-2-6
Shock resistance		Shock test with severity level 2 to FN 942017-5 and EN 60068-2-27
CE marking (see declaration of conformity) ³⁾		To EU EMC Directive ²⁾
		To EU RoHS Directive
UKCA marking (see declaration of conformity) ³⁾		To UK EMC regulations
		To UK RoHS regulations
KC marking		KC EMC
Certification		RCM
Degree of protection		IP65

1) More information: www.festo.com/x/topic/crc

2) For information about the area of use, see the declaration of conformity at: www.festo.com/catalogue/... → Support/Downloads.

If the devices are subject to usage restrictions in residential, commercial or light-industrial environments, further measures for the reduction of the emitted interference may be necessary.

3) More information: www.festo.com/catalogue/... → Support/Downloads.

Technical data – Manifold sub-base for valve terminal VTUX

Connection and display components

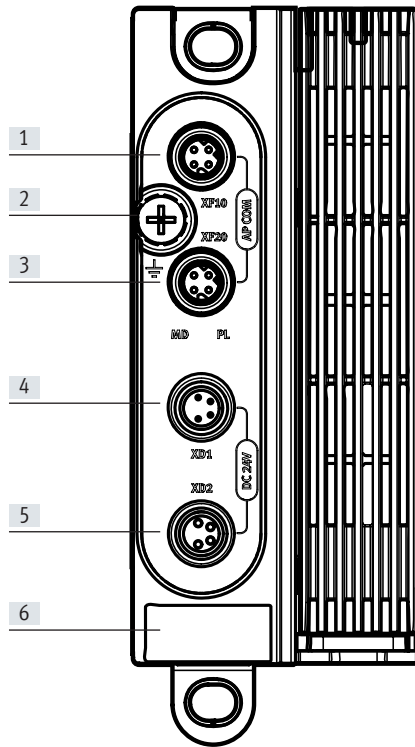

- [1] XF10 Communication interface
- [2] Earth connection
- [3] XF20 Communication interface
- [4] XD1 Electrical connection, power supply
- [5] XD2 Electrical connection, power transmission
- [6] Rating plate

Pin allocation of communication interface 2x socket M8x1, D-coded, 4-pin

Terminal allocation	Pin	Allocation	Description
	1	TX-	Transmitted data-
	2	RX+	Received data+
	3	TX+	Transmitted data+
	4	RX-	Received data-

Pin allocation of power supply M8x1, A-coded, 4-pin

Terminal allocation	Pin	Allocation	Description
	1	24 V	Operating voltage 24 V for electronics and sensors
	2	0 V	Operating voltage 0 V load voltage supply
	3	0 V	Operating voltage 0 V for electronics and sensors
	4	24 V	Operating voltage 24 V load voltage supply

Pin allocation for voltage transmission socket M8x1, A-coded, 4-pin

Terminal allocation	Pin	Allocation	Description
	1	24 V	Operating voltage 24 V for electronics and sensors
	2	0 V	Operating voltage 0 V load voltage supply
	3	0 V	Operating voltage 0 V for electronics and sensors
	4	24 V	Operating voltage 24 V load voltage supply

Technical data – Manifold sub-base for valve terminal VTUX

Ordering data		Part no.	Type
	Manifold sub-base for valve terminal VTUX	8189592	VABX-A-P-EL-E12-API-SHUH

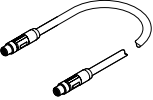
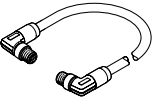
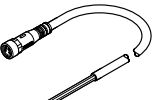
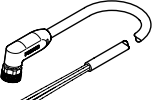
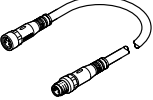
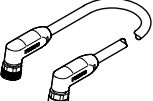
Ordering data – Accessories						
Description				Part no.	Type	
Connecting cable						
	For communication interface	Straight plug, M8x1, 4-pin, D-coded	Straight plug, M8x1, 4-pin, D-coded	0.3 m	8082902	NEBC-D8G4-ES-0.3-N-S-D8G4-ET
				0.5 m	8065123	NEBC-D8G4-ES-0.5-N-S-D8G4-ET
				1.0 m	8065125	NEBC-D8G4-ES-1-N-S-D8G4-ET
				2.0 m	8065127	NEBC-D8G4-ES-2-N-S-D8G4-ET
				5.0 m	8065129	NEBC-D8G4-ES-5-N-S-D8G4-ET
				7.5 m	8065131	NEBC-D8G4-ES-7.5-N-S-D8G4-ET
				10.0 m	8065133	NEBC-D8G4-ES-10-N-S-D8G4-ET
				15.0 m	8065135	NEBC-D8G4-ES-15-N-S-D8G4-ET
				20.0 m	8146031	NEBC-D8G4-ES-20-N-S-D8G4-ET
				25.0 m	8146032	NEBC-D8G4-ES-25-N-S-D8G4-ET
				30.0 m	8146033	NEBC-D8G4-ES-30-N-S-D8G4-ET
				40.0 m	8146034	NEBC-D8G4-ES-40-N-S-D8G4-ET
				50.0 m	8146035	NEBC-D8G4-ES-50-N-S-D8G4-ET
		Angled plug, M8x1, 4-pin, D-coded	Angled plug, M8x1, 4-pin, D-coded	0.5 m	8065124	NEBC-D8W4-ES-0.5-N-S-D8W4-ET
				1.0 m	8065126	NEBC-D8W4-ES-1-N-S-D8W4-ET
				2.0 m	8065128	NEBC-D8W4-ES-2-N-S-D8W4-ET
				5.0 m	8065130	NEBC-D8W4-ES-5-N-S-D8W4-ET
				7.5 m	8065132	NEBC-D8W4-ES-7.5-N-S-D8W4-ET
				10.0 m	8065134	NEBC-D8W4-ES-10-N-S-D8W4-ET
				15.0 m	8065136	NEBC-D8W4-ES-15-N-S-D8W4-ET
				20.0 m	8146036	NEBC-D8W4-ES-20-N-S-D8W4-ET
				25.0 m	8146037	NEBC-D8W4-ES-25-N-S-D8W4-ET
				30.0 m	8146038	NEBC-D8W4-ES-30-N-S-D8W4-ET
				40.0 m	8146039	NEBC-D8W4-ES-40-N-S-D8W4-ET
				50.0 m	8146040	NEBC-D8W4-ES-50-N-S-D8W4-ET
					For power supply	Straight socket, M8 x 1, 4-pin, A-coded
7.5 m	8065113	NEBL-M8G4-E-7.5-N-LE4				
10.0 m	8065117	NEBL-M8G4-E-10-N-LE4				
15.0 m	8065121	NEBL-M8G4-E-15-N-LE4				
		Angled socket, M8x1, 4-pin, A-coded	Open cable end, 4-wire	7.5 m	8065114	NEBL-M8W4-E-7.5-N-LE4
				10.0 m	8065118	NEBL-M8W4-E-10-N-LE4
				15.0 m	8065122	NEBL-M8W4-E-15-N-LE4
	For power transmission	Straight socket, M8 x 1, 4-pin, A-coded	Straight plug, M8 x 1, 4-pin, A-coded	0.3 m	8082904	NEBL-M8G4-E-0.3-N-M8G4
				0.5 m	8065102	NEBL-M8G4-E-0.5-N-M8G4
				1.0 m	8065104	NEBL-M8G4-E-1-N-M8G4
				2.0 m	8065106	NEBL-M8G4-E-2-N-M8G4
				5.0 m	8065108	NEBL-M8G4-E-5-N-M8G4
				7.5 m	8065111	NEBL-M8G4-E-7.5-N-M8G4
				10.0 m	8065115	NEBL-M8G4-E-10-N-M8G4
				15.0 m	8065119	NEBL-M8G4-E-15-N-M8G4
		Angled socket, M8x1, 4-pin, A-coded	Angled plug, M8x1, 4-pin, A-coded	0.3 m	8146577	NEBL-M8W4-E-0.3-N-M8W4
				0.5 m	8065103	NEBL-M8W4-E-0.5-N-M8W4
				1.0 m	8065105	NEBL-M8W4-E-1-N-M8W4
				2.0 m	8065107	NEBL-M8W4-E-2-N-M8W4
				5.0 m	8065109	NEBL-M8W4-E-5-N-M8W4
				7.5 m	8065112	NEBL-M8W4-E-7.5-N-M8W4
				10.0 m	8065116	NEBL-M8W4-E-10-N-M8W4
				15.0 m	8065120	NEBL-M8W4-E-15-N-M8W4

Technical data – Manifold sub-base for valve terminal VTUX

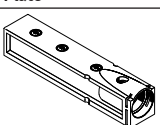
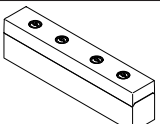
Ordering data – Accessories					
	Description		Pack size	Part no.	Type
Cover cap					
	For sealing unused connections	For connection M8x1	10	177672	ISK-M8
Plate					
	Position function 1-64: UD	Plate for ducted exhaust air, without cartridge, for mounting on manifold sub-base for VTUX		8191794	VABF-XA-12-M2-QX
	Position function 1-64: US	Exhaust plate for mounting on manifold sub-base for VTUX		8191741	VABF-XA-12-M1-C

Technical data – Electrical interface for valve terminal VTUG

Function

The electrical interface facilitates a valve terminal VTUG to be operated as a component of the automation system CPX-AP-I.

- Indication of status and error messages via LED indicators
- Up to 24 valve positions with up to 48 solenoid coils
- Separate load voltage supply for the connected valves; can be disconnected separately
- Short-circuit disconnection

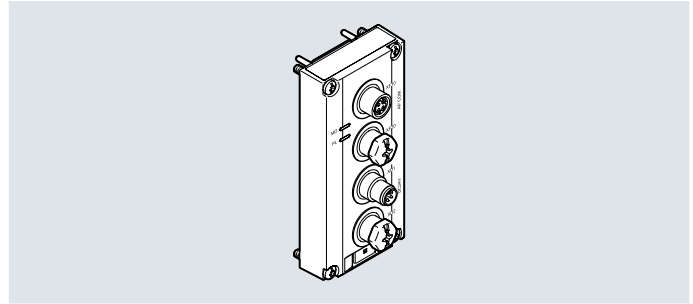

General technical data

Type	VAEM-L1-S-12-AP	VAEM-L1-S-24-AP
Maximum number of valve positions	12	24
Max. no. of solenoid coils	24	48

Communication interface

Protocol	AP-COM
Function	System communication XF10 IN / XF20 OUT
Connection type	2 x socket
Connection technology	M8x1, D-coded to EN 61076-2-114
Number of pins/wires	4
Screening	Yes

General data

Module parameters	Configuration of voltage monitoring of load supply PL Response in error state
Diagnostics via LED	Diagnostics per module Power supply load
Diagnostics via internal communication	Electronics/sensors overvoltage Electronics/sensors undervoltage Load overvoltage Load undervoltage Load switch-off
Maximum cable length [m]	50 system communication

Technical data – Electrical interface for valve terminal VTUG

Technical data – Electrical components			
Type		VAEM-L1-S-12-AP	VAEM-L1-S-24-AP
Nominal operating voltage, electronics/sensors	[V DC]	24	24
Permissible voltage fluctuations for electronics/sensors	[%]	±25	±25
Nominal operating voltage, load	[V DC]	24	24
Permissible voltage fluctuations, load	[%]	±10	±10
Note on operating voltage		SELV/PELV power supply units required	SELV/PELV power supply units required
		Note voltage drop	Note voltage drop
Power failure buffering	[ms]	10	10
Mains buffering of load	[ms]	3	3
Maximum power supply		2 x 4 A (external fuse required)	2 x 4 A (external fuse required)
Fuse protection (short circuit)		Internal electronic fuse per channel	Internal electronic fuse per channel
Protection against direct and indirect contact		PELV	PELV
		SELV	SELV
Reverse polarity protection		Yes	Yes
Intrinsic current consumption at nominal operating voltage for electronics/sensors	[mA]	Typically 34	Typically 34
Intrinsic current consumption at nominal operating voltage, load	[mA]	Typically 16	Typically 22
Electrical connection, power supply			
Function		Incoming electronics/sensors and load	Incoming electronics/sensors and load
Connection type		Plug	Plug
Connection technology		M8x1, A-coded to EN 61076-2-104	M8x1, A-coded to EN 61076-2-104
Number of pins/wires		4	4
Electrical connection, power transmission			
Function		Outgoing electronics/sensors and load	Outgoing electronics/sensors and load
Connection type		Socket	Socket
Connection technology		M8x1, A-coded to EN 61076-2-104	M8x1, A-coded to EN 61076-2-104
Number of pins/wires		4	4

Technical data – Electrical interface for valve terminal VTUG

Technical data – Mechanical components		
Type of mounting		Screw-clamped
Connection position		On top
Product weight	[g]	76
Dimensions W x L x H	[mm]	42 x 91 x 30
Materials		
Housing		Reinforced PA
Threaded sleeve		Nickel-plated brass
Note on materials		RoHS-compliant
PWIS conformity		VDMA24364-B1/B2-L
Operating and environmental conditions		
Ambient temperature	[°C]	-5 ... +50
Storage temperature	[°C]	-20 ... +60
Corrosion resistance class CRC ¹⁾		2
Relative humidity	[%]	5 ... 95
		Non-condensing
Nominal altitude of use		≤ 2000 m above sea level
CE marking (see declaration of conformity) ³⁾		To EU EMC Directive ²⁾
KC mark		KC EMC
UKCA marking (see declaration of conformity)		To UK instructions for EMC
Certification		RCM
		c UL us - Recognized (OL)
Degree of protection		IP65
		IP67
Note on degree of protection		In assembled state
		Unused connections sealed

1) Additional information: www.festo.com/x/topic/kbk

2) For information about the area of use, see the EC declaration of conformity at: www.festo.com/catalogue/... → Support/Downloads.

If the devices are subject to usage restrictions in residential, commercial or light-industrial environments, further measures for the reduction of the emitted interference may be necessary.

3) Additional information: www.festo.com/catalogue/... → Support/Downloads.

Technical data – Electrical interface for valve terminal VTUG

Connection and display components

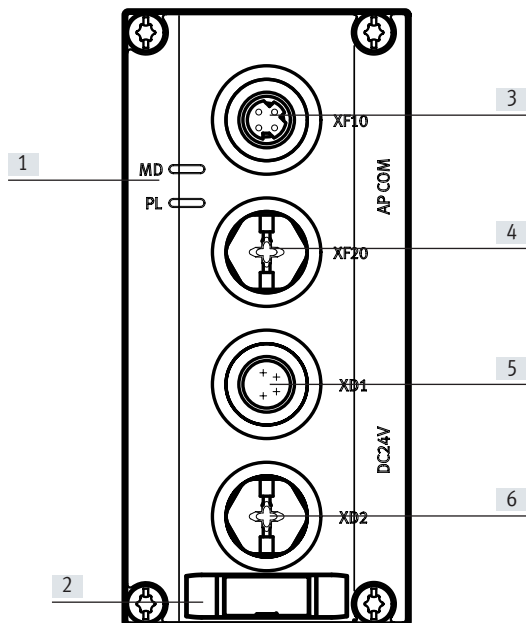

- [1] LED indicators
- [2] Space for inscription label
- [3] Communication interface
- [4] Communication interface 2
- [5] Electrical connection, power supply
- [6] Electrical connection, power transmission

Dimensions

Download CAD data → www.festo.com

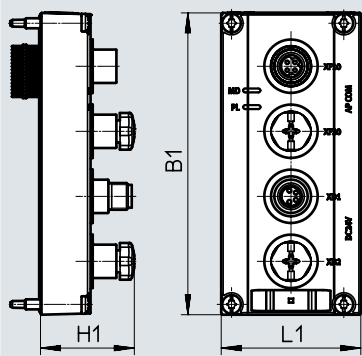

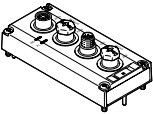
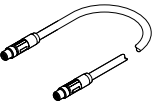
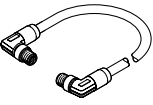
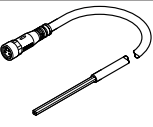
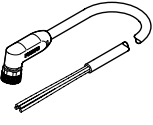
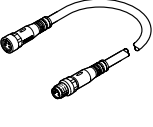
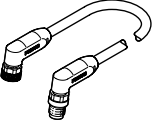

	B1	H1	L1
VAEM-L1-S-12-AP	90.5	28.1	41.8
VAEM-L1-S-24-AP	90.5	28.1	41.8

Technical data – Electrical interface for valve terminal VTUG

Ordering data				Part No.	Type					
	Electrical interface for valve terminal VTUG		12 valve positions	8081922	VAEM-L1-S-12-AP					
			24 valve positions	8081923	VAEM-L1-S-24-AP					
Ordering data – Accessories										
Connecting cable				Part No.	Type					
Description										
	For communication interface	Straight plug, M8x1, 4-pin, D-coded	Straight plug, M8x1, 4-pin, D-coded	0.3 m	8082902	NEBC-D8G4-ES-0.3-N-S-D8G4-ET				
				0.5 m	8065123	NEBC-D8G4-ES-0.5-N-S-D8G4-ET				
				1.0 m	8065125	NEBC-D8G4-ES-1-N-S-D8G4-ET				
				2.0 m	8065127	NEBC-D8G4-ES-2-N-S-D8G4-ET				
				5.0 m	8065129	NEBC-D8G4-ES-5-N-S-D8G4-ET				
				7.5 m	8065131	NEBC-D8G4-ES-7.5-N-S-D8G4-ET				
				10.0 m	8065133	NEBC-D8G4-ES-10-N-S-D8G4-ET				
				15.0 m	8065135	NEBC-D8G4-ES-15-N-S-D8G4-ET				
				20.0 m	8146031	NEBC-D8G4-ES-20-N-S-D8G4-ET				
				25.0 m	8146032	NEBC-D8G4-ES-25-N-S-D8G4-ET				
				30.0 m	8146033	NEBC-D8G4-ES-30-N-S-D8G4-ET				
				40.0 m	8146034	NEBC-D8G4-ES-40-N-S-D8G4-ET				
				50.0 m	8146035	NEBC-D8G4-ES-50-N-S-D8G4-ET				
					For communication interface	Angled plug, M8x1, 4-pin, D-coded	Angled plug, M8x1, 4-pin, D-coded	0.5 m	8065124	NEBC-D8W4-ES-0.5-N-S-D8W4-ET
1.0 m	8065126	NEBC-D8W4-ES-1-N-S-D8W4-ET								
2.0 m	8065128	NEBC-D8W4-ES-2-N-S-D8W4-ET								
5.0 m	8065130	NEBC-D8W4-ES-5-N-S-D8W4-ET								
7.5 m	8065132	NEBC-D8W4-ES-7.5-N-S-D8W4-ET								
10.0 m	8065134	NEBC-D8W4-ES-10-N-S-D8W4-ET								
15.0 m	8065136	NEBC-D8W4-ES-15-N-S-D8W4-ET								
20.0 m	8146036	NEBC-D8W4-ES-20-N-S-D8W4-ET								
25.0 m	8146037	NEBC-D8W4-ES-25-N-S-D8W4-ET								
30.0 m	8146038	NEBC-D8W4-ES-30-N-S-D8W4-ET								
40.0 m	8146039	NEBC-D8W4-ES-40-N-S-D8W4-ET								
50.0 m	8146040	NEBC-D8W4-ES-50-N-S-D8W4-ET								
	For power supply	Straight socket, M8 x 1, 4-pin, A-coded	Open cable end, 4-wire					5.0 m	8065110	NEBL-M8G4-E-5-N-LE4
								7.5 m	8065113	NEBL-M8G4-E-7.5-N-LE4
				10.0 m	8065117	NEBL-M8G4-E-10-N-LE4				
				15.0 m	8065121	NEBL-M8G4-E-15-N-LE4				
	For power supply	Angled socket, M8x1, 4-pin, A-coded	Open cable end, 4-wire	7.5 m	8065114	NEBL-M8W4-E-7.5-N-LE4				
				10.0 m	8065118	NEBL-M8W4-E-10-N-LE4				
				15.0 m	8065122	NEBL-M8W4-E-15-N-LE4				
	For power transmission	Straight socket, M8 x 1, 4-pin, A-coded	Straight plug, M8 x 1, 4-pin, A-coded	0.3 m	8082904	NEBL-M8G4-E-0.3-N-M8G4				
				0.5 m	8065102	NEBL-M8G4-E-0.5-N-M8G4				
				1.0 m	8065104	NEBL-M8G4-E-1-N-M8G4				
				2.0 m	8065106	NEBL-M8G4-E-2-N-M8G4				
				5.0 m	8065108	NEBL-M8G4-E-5-N-M8G4				
				7.5 m	8065111	NEBL-M8G4-E-7.5-N-M8G4				
				10.0 m	8065115	NEBL-M8G4-E-10-N-M8G4				
				15.0 m	8065119	NEBL-M8G4-E-15-N-M8G4				
	For power transmission	Angled socket, M8x1, 4-pin, A-coded	Angled plug, M8x1, 4-pin, A-coded	0.3 m	8146577	NEBL-M8W4-E-0.3-N-M8W4				
				0.5 m	8065103	NEBL-M8W4-E-0.5-N-M8W4				
				1.0 m	8065105	NEBL-M8W4-E-1-N-M8W4				
				2.0 m	8065107	NEBL-M8W4-E-2-N-M8W4				
				5.0 m	8065109	NEBL-M8W4-E-5-N-M8W4				
				7.5 m	8065112	NEBL-M8W4-E-7.5-N-M8W4				
				10.0 m	8065116	NEBL-M8W4-E-10-N-M8W4				
				15.0 m	8065120	NEBL-M8W4-E-15-N-M8W4				

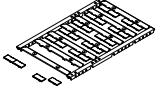
Technical data – Electrical interface for valve terminal VTUG

Ordering data – Accessories					
	Description		Pack size	Part No.	Type
Inscription label					
	For modules CPX-AP-I	Size 6x 12.5 mm, 10 frames with 24 pieces each	240	8087174	ASLR-L-X4-612-P240
Cover cap					
	For sealing unused connections	For connection M8x1	10	177672	ISK-M8

Technical data – Electrical interface for valve terminal MPA-L

Function

The electrical interface facilitates a valve terminal MPA-L to be operated as a component of the automation system CPX-AP-I.

- Indication of status and error messages via LED indicators
- Up to 32 valve positions with up to 32 solenoid coils
- Separate load voltage supply for the connected valves; can be disconnected separately
- Short-circuit disconnection, short-circuit diagnostics and switching cycle counter

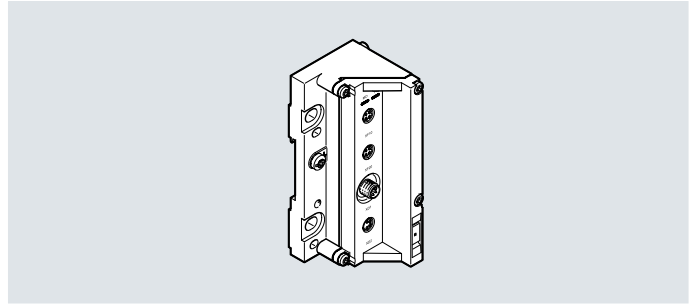

General technical data	
Maximum number of valve positions	32
Max. no. of solenoid coils	32
Communication interface	
Protocol	AP-COM
Function	System communication XF10 IN / XF20 OUT
Connection type	2 x socket
Connection technology	M8x1, D-coded to EN 61076-2-114
Number of pins/wires	4
Screening	Yes
General data	
Diagnostics via LED	Diagnostics per module Power supply load
Diagnostics via internal communication	Electronics/sensors overvoltage Electronics/sensors undervoltage
Electrical isolation of outputs between channel and internal communication	Yes
Maximum cable length	[m] 50 system communication
Technical data – Electrical components	
Nominal operating voltage, electronics/sensors	[V DC] 24
Permissible voltage fluctuations for electronics/sensors	[%] ±25
Nominal operating voltage, load	[V DC] 24
Permissible voltage fluctuations, load	[%] ±10
Power failure buffering	[ms] 10
Mains buffering of load	[ms] 3
Maximum power supply	2 x 4 A (external fuse required)
Fuse protection (short circuit)	Internal electronic fuse per channel
Protection against direct and indirect contact	PELV SELV
Reverse polarity protection	Yes
Intrinsic current consumption at nominal operating voltage for electronics/sensors	[mA] Typically 30
Intrinsic current consumption at nominal operating voltage, load	[mA] Typically 15
Electrical connection, power supply	
Function	Incoming electronics/sensors and load
Connection type	Plug
Connection technology	M8x1, A-coded to EN 61076-2-104
Number of pins/wires	4
Electrical connection, power transmission	
Function	Outgoing electronics/sensors and load
Connection type	Socket
Connection technology	M8x1, A-coded to EN 61076-2-104
Number of pins/wires	4

Technical data – Electrical interface for valve terminal MPA-L

Technical data – Mechanical components		
Valve terminal design		Valve sizes can be mixed
Type of mounting		Tie rod
Connection position		On top
Product weight	[g]	194
Dimensions W x L x H	[mm]	43.1 x 107.5 x 50.2
Materials		
Housing		Die-cast aluminium, painted
		Reinforced PA
Threaded sleeve		Nickel-plated brass
Note on materials		RoHS-compliant
PWIS conformity		VDMA24364-B1/B2-L
Operating and environmental conditions		
Ambient temperature	[°C]	-5 ... +50
Storage temperature	[°C]	-40 ... +70
Corrosion resistance class CRC ¹⁾		3
Relative humidity	[%]	5 ... 95
		Non-condensing
Nominal altitude of use		≤ 2000 m above sea level
CE marking (see declaration of conformity) ³⁾		To EU EMC Directive ²⁾
		To EU RoHS Directive
KC mark		KC EMC
UKCA marking (see declaration of conformity) ³⁾		To UK instructions for EMC
		To UK RoHS instructions
Certification		RCM
Degree of protection		IP65
		IP67
Note on degree of protection		In assembled state
		Unused connections sealed

1) Additional information: www.festo.com/x/topic/kbk

2) For information about the area of use, see the EC declaration of conformity at: www.festo.com/catalogue/... → Support/Downloads.

If the devices are subject to usage restrictions in residential, commercial or light-industrial environments, further measures for the reduction of the emitted interference may be necessary.

3) Additional information: www.festo.com/catalogue/... → Support/Downloads.

Technical data – Electrical interface for valve terminal MPA-L

Connection and display components

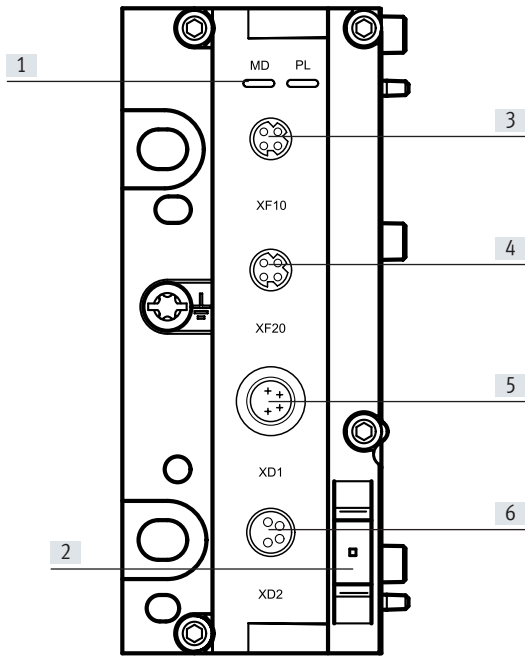

- [1] LED indicators
- [2] Space for inscription label
- [3] Communication interface
- [4] Communication interface 2
- [5] Electrical connection, power supply
- [6] Electrical connection, power transmission

Dimensions

Download CAD data → www.festo.com

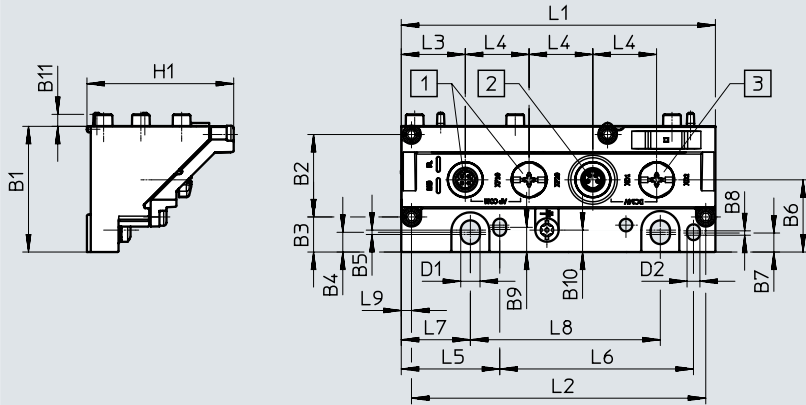

[1] Socket M8x1, D-coded

[2] Plug M8x1, A-coded

[3] Socket M8x1, A-coded

	B1	B2	B3	B4	B5	B6	B7	B8	B9	B10	B11	D1	D2	H1
VMPAL-EPL-AP	43	28.2	12	6.8	1.5	24.7	6.5	1.5	8.5	7.5	4.1	6.6	4.4	50.2

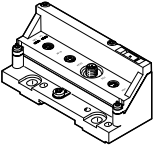

	L1	L2	L3	L4	L5	L6	L7	L8	L9
VMPAL-EPL-AP	107.5	100.7	21.9	21.8	33.7	66.3	23.7	65	3.5

Technical data – Electrical interface for valve terminal MPA-L

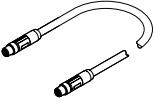
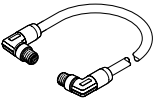
Ordering data		Part No.	Type
	Electrical interface for valve terminal MPA-L	32 valve positions	8087171 VMPAL-EPL-AP

Ordering data – Accessories						
Description				Part No.	Type	
Connecting cable						
	For communication interface	Straight plug, M8x1, 4-pin, D-coded	Straight plug, M8x1, 4-pin, D-coded	0.3 m	8082902	NEBC-D8G4-ES-0.3-N-S-D8G4-ET
				0.5 m	8065123	NEBC-D8G4-ES-0.5-N-S-D8G4-ET
				1.0 m	8065125	NEBC-D8G4-ES-1-N-S-D8G4-ET
				2.0 m	8065127	NEBC-D8G4-ES-2-N-S-D8G4-ET
				5.0 m	8065129	NEBC-D8G4-ES-5-N-S-D8G4-ET
				7.5 m	8065131	NEBC-D8G4-ES-7.5-N-S-D8G4-ET
				10.0 m	8065133	NEBC-D8G4-ES-10-N-S-D8G4-ET
				15.0 m	8065135	NEBC-D8G4-ES-15-N-S-D8G4-ET
				20.0 m	8146031	NEBC-D8G4-ES-20-N-S-D8G4-ET
				25.0 m	8146032	NEBC-D8G4-ES-25-N-S-D8G4-ET
				30.0 m	8146033	NEBC-D8G4-ES-30-N-S-D8G4-ET
				40.0 m	8146034	NEBC-D8G4-ES-40-N-S-D8G4-ET
				50.0 m	8146035	NEBC-D8G4-ES-50-N-S-D8G4-ET
		Angled plug, M8x1, 4-pin, D-coded	Angled plug, M8x1, 4-pin, D-coded	0.5 m	8065124	NEBC-D8W4-ES-0.5-N-S-D8W4-ET
				1.0 m	8065126	NEBC-D8W4-ES-1-N-S-D8W4-ET
				2.0 m	8065128	NEBC-D8W4-ES-2-N-S-D8W4-ET
				5.0 m	8065130	NEBC-D8W4-ES-5-N-S-D8W4-ET
				7.5 m	8065132	NEBC-D8W4-ES-7.5-N-S-D8W4-ET
				10.0 m	8065134	NEBC-D8W4-ES-10-N-S-D8W4-ET
				15.0 m	8065136	NEBC-D8W4-ES-15-N-S-D8W4-ET
				20.0 m	8146036	NEBC-D8W4-ES-20-N-S-D8W4-ET
				25.0 m	8146037	NEBC-D8W4-ES-25-N-S-D8W4-ET
				30.0 m	8146038	NEBC-D8W4-ES-30-N-S-D8W4-ET
				40.0 m	8146039	NEBC-D8W4-ES-40-N-S-D8W4-ET
50.0 m	8146040	NEBC-D8W4-ES-50-N-S-D8W4-ET				

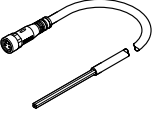
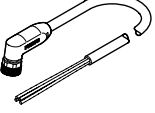
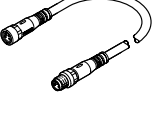
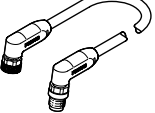
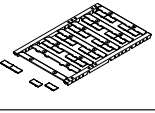
Technical data – Electrical interface for valve terminal MPA-L

Ordering data – Accessories						
	Description			Part No.	Type	
Connecting cable						
	For power supply	Straight socket, M8 x 1, 4-pin, A-coded	Open cable end, 4-wire	5.0 m	8065110	NEBL-M8G4-E-5-N-LE4
				7.5 m	8065113	NEBL-M8G4-E-7.5-N-LE4
				10.0 m	8065117	NEBL-M8G4-E-10-N-LE4
				15.0 m	8065121	NEBL-M8G4-E-15-N-LE4
		Angled socket, M8x1, 4-pin, A-coded	Open cable end, 4-wire	7.5 m	8065114	NEBL-M8W4-E-7.5-N-LE4
				10.0 m	8065118	NEBL-M8W4-E-10-N-LE4
				15.0 m	8065122	NEBL-M8W4-E-15-N-LE4
	For power transmission	Straight socket, M8 x 1, 4-pin, A-coded	Straight plug, M8 x 1, 4-pin, A-coded	0.3 m	8082904	NEBL-M8G4-E-0.3-N-M8G4
				0.5 m	8065102	NEBL-M8G4-E-0.5-N-M8G4
				1.0 m	8065104	NEBL-M8G4-E-1-N-M8G4
				2.0 m	8065106	NEBL-M8G4-E-2-N-M8G4
				5.0 m	8065108	NEBL-M8G4-E-5-N-M8G4
				7.5 m	8065111	NEBL-M8G4-E-7.5-N-M8G4
				10.0 m	8065115	NEBL-M8G4-E-10-N-M8G4
				15.0 m	8065119	NEBL-M8G4-E-15-N-M8G4
		Angled socket, M8x1, 4-pin, A-coded	Angled plug, M8x1, 4-pin, A-coded	0.3 m	8146577	NEBL-M8W4-E-0.3-N-M8W4
				0.5 m	8065103	NEBL-M8W4-E-0.5-N-M8W4
				1.0 m	8065105	NEBL-M8W4-E-1-N-M8W4
				2.0 m	8065107	NEBL-M8W4-E-2-N-M8W4
				5.0 m	8065109	NEBL-M8W4-E-5-N-M8W4
				7.5 m	8065112	NEBL-M8W4-E-7.5-N-M8W4
				10.0 m	8065116	NEBL-M8W4-E-10-N-M8W4
				15.0 m	8065120	NEBL-M8W4-E-15-N-M8W4
Ordering data – Accessories						
	Description			Pack size	Part No.	Type
Inscription label						
	For modules CPX-AP-I	Size 6x 12.5 mm, 10 frames with 24 pieces each		240	8087174	ASLR-L-X4-612-P240
Cover cap						
	For sealing unused connections		For connection M8x1	10	177672	ISK-M8