

Measuring modules CPX-CMIX

FESTO



Key features

At a glance

Movement and measurement in one, as an integral component of the valve terminal CPX – the modular peripheral system for decentralised automation tasks. The modular design means that valves, digital inputs and outputs, positioning modules, end-position controllers and measuring modules, as appropriate to the application, can be combined in almost any way on the terminal CPX.

Advantages:

- Pneumatics and electrics – movement and measurement on one platform
- Innovative measurement technology – piston rod drives, rodless drives, rotary drives
- Actuation via fieldbus
- Remote maintenance, remote diagnostics, web server, SMS and e-mail alerts are all possible via TCP/IP
- Modules can be quickly exchanged and expanded without altering the wiring

Retracting/advancing and measuring in one work step	Time and space-saving	Process reliability	Reduced system costs
Fully digital data acquisition and transmission means pneumatic cylinders can now be used as sensors. With very high repetition accuracy and incorporating both analogue and digital measuring sensors.	Electrical peripherals enable the highly efficient measuring module to be seamlessly and compactly integrated into existing control environments. The new component is tailored to a tried-and-tested system and is quick and easy to commission.	All process steps are measured and documented, which significantly improves quality. The adjustable contact force (via pressure regulator) also increases the precision of the "displacement sensor".	As with all modules in the electrical terminal CPX, easy functional integration in fieldbus/Ethernet networks is a matter of course.

Drives to use

Linear drives DGCI

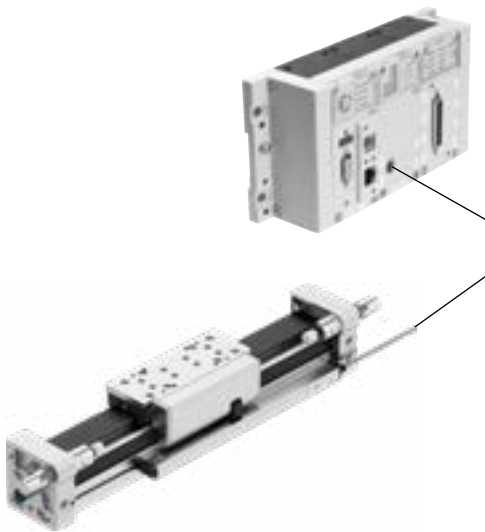

- The measuring signal of the linear drive DGCI supplies a CAN signal. This signal is read directly into the CPX-CMIX module
- The measuring system measures absolute values, in other words the actual position is immediately available for the controller after the system is switched on

Technical data

Linearity error ¹⁾	[%]	< ±0.02, min. ±50 µm
Resolution	[mm]	0.01
Repetition accuracy ²⁾	[mm]	±0.01/±0.02
Hysteresis	[µm]	< 4
Max. temperature coefficient	[ppm/°K]	15
Smallest measurable speed	[mm/s]	10

1) Always refers to max. stroke.

2) Stroke ≤ 1000 mm/stroke > 1000 mm

Key features

Drives to use

Displacement encoder MME

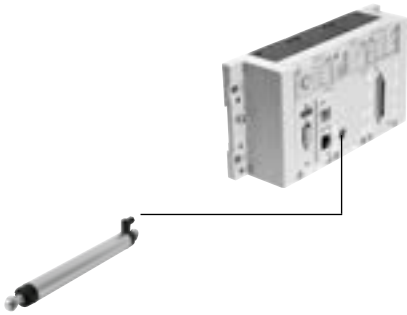

- The measuring signal of the displacement encoder MME supplies a CAN signal. This signal is read directly into the CPX-CMIX module
- The measuring system measures absolute values, in other words the actual position is immediately available for the controller after the system is switched on

Technical data

Linearity error ¹⁾	[%]	< ±0.01, min. ±40 µm
Resolution	[mm]	0.01
Repetition accuracy ²⁾	[mm]	±0.01/±0.02
Hysteresis	[µm]	< 4
Max. temperature coefficient	[ppm/°K]	15
Smallest measurable speed	[mm/s]	10

1) Always refers to max. stroke.

2) Stroke ≤ 1000 mm/stroke > 1000 mm

Linear drives DNCI

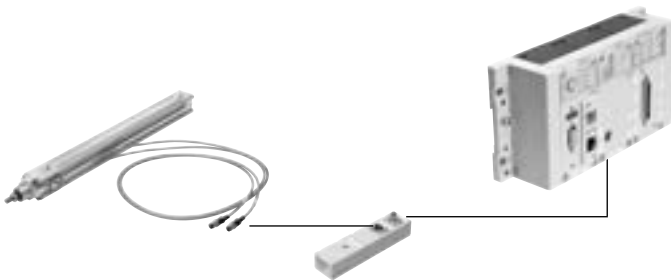

- The measuring signal of the linear drive DNCI is an incremental signal. This signal is converted to a CAN signal in the sensor interface CASM-S-D3-R7. The converted signal is then read into the CPX-CMIX module
- The measuring system does not measure absolute values, so must be homed after it is switched on. The actual position is available for the controller once this has been done

Technical data

Linearity error		
Strokes up to 500 mm	[mm]	< ±0.08
Strokes up to 1000 mm	[mm]	< ±0.09
Strokes over 1000 mm	[mm]	< ±0.11
Resolution	[mm]	0.01
Repetition accuracy	[mm]	< ±0.02
Hysteresis	[mm]	< 0.03
Smallest measurable speed	[mm/s]	10

Key features

Drives to use

Swivel modules DSMI or potentiometers MLO-POT

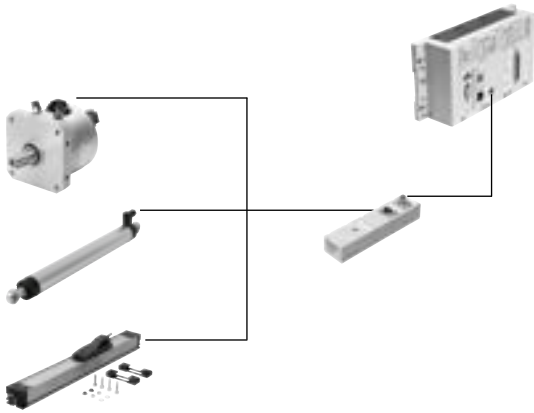

- The measuring systems supply an analogue measuring signal. This signal is converted to a CAN signal in the sensor interface CASM-S-D2-R3. The converted signal is then read into the CPX-CMIX module
- Potentiometers measure absolute values, in other words the actual position is immediately available for the controller after the potentiometer is switched on

Other potentiometers can be used, in which case the following must be noted:

- The connection resistance of the potentiometer must be 3 ... 20 kΩ
- Poorer potentiometer values for linearity and temperature coefficient will decrease the accuracy of the measured value
- A special cable must be used for connection to the sensor interface

Technical data

Measuring length	[mm]	100	150	225	300	360	450	500
Linearity error								
MLO-POT	[%]	±0.1	±0.08	±0.07	±0.06	±0.05	±0.05	±0.05
DSMI ¹⁾	[%]	< ±0.25						
Resolution								
MLO-POT	[mm]	±0.01	±0.01	±0.01	±0.01	±0.01	±0.01	±0.01
DSMI	[°]	< ±0.1						
Repetition accuracy								
MLO-POT	[mm]	±0.01	±0.01	±0.01	±0.01	±0.02	±0.02	±0.02
DSMI	[°]	< ±0.1						
Smallest measurable speed	[mm/s]	3	5	7	9	11	14	15
Temperature coefficient	[ppm/°K]	5						

Measuring length	[mm]	600	750	1000	1250	1500	1750	2000
Linearity error								
MLO-POT	[%]	±0.05	±0.04	±0.04	±0.03	±0.03	±0.03	±0.02
DSMI ¹⁾	[%]	< ±0.25						
Resolution								
MLO-POT	[mm]	±0.01	±0.02	±0.02	±0.02	±0.03	±0.03	±0.03
DSMI	[°]	< ±0.1						
Repetition accuracy								
MLO-POT	[mm]	±0.02	±0.03	±0.03	±0.04	±0.05	±0.06	±0.07
DSMI	[°]	< ±0.1						
Smallest measurable speed	[mm/s]	18	23	31	38	46	53	61
Temperature coefficient	[ppm/°K]	5						

1) Refers to max. swivel angle

Type codes and peripherals overview

Type codes

001	Series
CPX-CMIX	Measuring module for electrical terminal
002	Function module
M1	Measuring unit

003	Axes
1	One

Peripherals overview

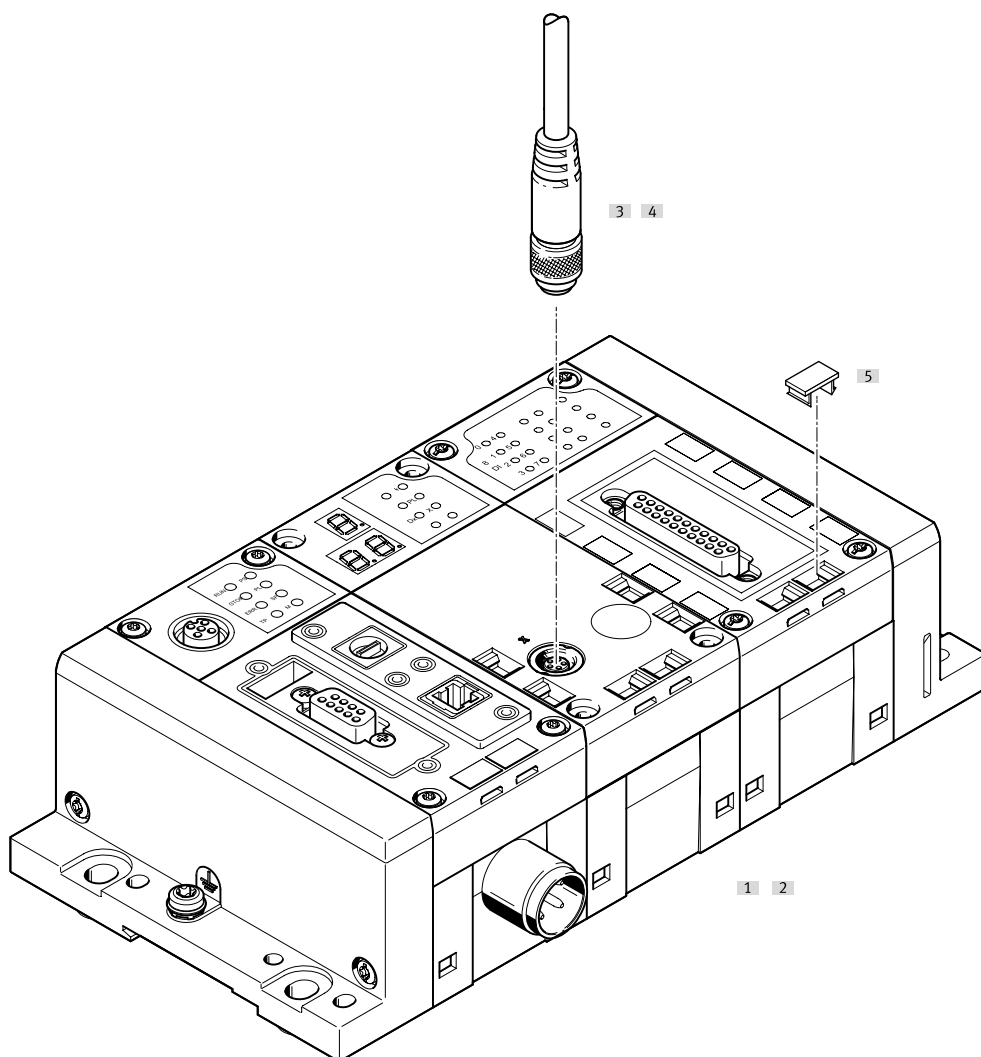

Accessories			
Type		Description	→ Page/Internet
[1]	Measuring module	CPX-CMIX Integrated in the CPX terminal. Screws for mounting on the polymer interlinking block are included in the scope of delivery	6
[3]	Connecting cable	KVI-CP-3 For connecting the measuring module CPX-CMIX and sensor interface CASM	8
[5]	Inscription label	IBS For labelling the modules	8
[2]	Interlinking block	CPX-GE Connects the individual modules. Two versions are available: polymer or metal interlinking block.	9
-	Screws	CPX-M-M3 For mounting on the metal interlinking block	8
-	Connecting cable	NEBC-P1W4 For connecting the sensor interface CASM and swivel module DSMI or potentiometer LWG	nebc
-	Connecting cable	NEBC-A1W3 For connecting the sensor interface CASM and potentiometer TLF	nebc
[4]	Connecting cable	NEBP-M16W6 For connecting the measuring module CPX-CMIX and displacement encoder MME	8

Data sheet

The measuring module CPX-CMIX is intended exclusively for use in valve terminals CPX.

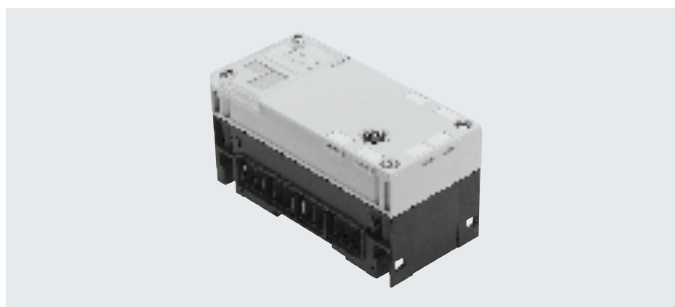

General technical data

Operating voltage

Operating voltage range	[V DC]	18 ... 30
Nominal operating voltage	[V DC]	24
Current consumption at nominal operating voltage	[mA]	80
Short circuit protection		Yes
Power failure buffering	[ms]	10

Number of axis strings		1	
Axes per string		1	
Length of connecting cable to axis	[m]	≤ 30	
Max. number of modules		9	
Display		7-segment display	
Assigned addresses	Outputs	[bit]	6x8
	Inputs	[bit]	6x8

Diagnostics		Channel and module-oriented
		Via local 7-segment display
		Undervoltage of modules
		Undervoltage of measuring system

Status indication		Power load
		Error

Control interface

Data		CAN bus with Festo protocol
		Digital
Electrical connection		5-pin
		M9
		Socket

Materials: housing		Reinforced PA	
Note on materials		RoHS-compliant	
PWIS conformity		VDMA24364-B2-L	
Product weight	[g]	140	
Dimensions	Length	[mm]	107
	Width	[mm]	50
	Height	[mm]	55

Data sheet

Operating and environmental conditions		
Ambient temperature	[°C]	-5 ... +50
Storage temperature	[°C]	-20 ... +70
Relative humidity	[%]	5 ... 95, non-condensing
Degree of protection to IEC 60529		IP65

Connection and display components

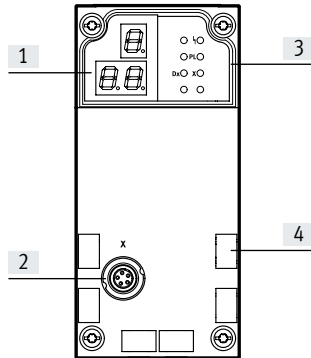

- [1] 3-digit display
- [2] Control interface
- [3] Status LEDs
- [4] Inscription labels

Pin allocation – Control interface

	Pin	Signal	Designation
	1	+24 V	Nominal operating voltage
	2	+24 V	Load voltage
	3	0 V	Ground
	4	CAN_H	CAN high
	5	CAN_L	CAN low
	Housing	Shielding	Cable shielding





Permitted bus nodes/CEC

Bus node/CEC	Protocol	Max. number of CMIX modules
CPX-CEC...	-	9
CPX-FB11	DeviceNet ¹⁾	9
CPX-FB13	PROFIBUS ²⁾	9
CPX-FB14	CANopen	5
CPX-FB23-24	CC-LINK	5 (as function module F23)
		9 (as functional module F24)
CPX-FB36	EtherNet/IP	9
CPX-FB37	EtherCAT	9
CPX-FB39	Sercos III	9
CPX-FB40	POWERLINK	9
CPX-FB43	PROFINET RT, M12	9
CPX-M-FB44	PROFINET RT, RJ45	9
CPX-M-FB45	PROFINET RT, SCRJ	9

1) As of revision 20 (R20)

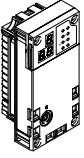
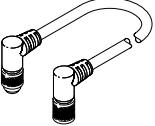

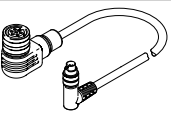
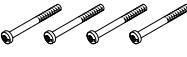
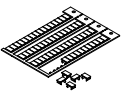
2) As of revision 23 (R23)

Accessories

Ordering data		Brief description	Part no.	Type
Measuring module				
	Order code in the CPX configurator: T23		567417	CPX-CMIX-M1-1
Connecting cables				
	Connecting cable with angled plug and angled socket	0.25 m	540327	KVI-CP-3-WS-WD-0.25
		0.5 m	540328	KVI-CP-3-WS-WD-0.5
		2 m	540329	KVI-CP-3-WS-WD-2
		5 m	540330	KVI-CP-3-WS-WD-5
	Connecting cable with straight plug and straight socket	2 m	540332	KVI-CP-3-GS-GD-2
		5 m	540333	KVI-CP-3-GS-GD-5
	8 m	540334	KVI-CP-3-GS-GD-8	
	Connecting component for control cabinet through-feed		543252	KVI-CP-3-SSD
	For displacement encoder MME: Connection between displacement encoder MME and measuring module CPX-CMIX	2 m	575898	NEBP-M16W6-K-2-M9W5
Screws				
	For mounting on the metal interlinking block		550219	CPX-M-M3X22-4X
Inscription labels				
	Inscription labels 6x10, in frames	64 pieces	18576	IBS-6X10
User documentation				
	Description of measuring module CPX-CMIX ¹⁾	German	567053	P.BE-CPX-CMIX-DE
		English	567054	P.BE-CPX-CMIX-EN
		Spanish	567055	P.BE-CPX-CMIX-ES
		French	567056	P.BE-CPX-CMIX-FR
		Italian	567057	P.BE-CPX-CMIX-IT

1) User documentation in paper form is not included in the scope of delivery

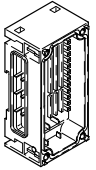
Accessories

Ordering data	Brief description	Part no.	Type	
Polymer interlinking block as extension block				
	Without power supply	–	195742	CPX-GE-EV
	With additional supply for outputs	M18 – 4-pin	195744	CPX-GE-EV-Z
		7/8" – 5-pin	541248	CPX-GE-EV-Z-7/8-5POL
		7/8" – 4-pin	541250	CPX-GE-EV-Z-7/8-4POL
	With additional power supply for valves	M18 – 4-pin	533577	CPX-GE-EV-V
7/8" – 4-pin		541252	CPX-GE-EV-V-7/8-4POL	
Tie rods				
	For expansion using an interlinking block	1 module	525418	CPX-ZA-1-E