

## Data sheet

**Inscription label KM-BZ, IBS, KMC, MH, ASLR**

Inscription labels for identification, can be used in holders or carriers on suitably equipped components.

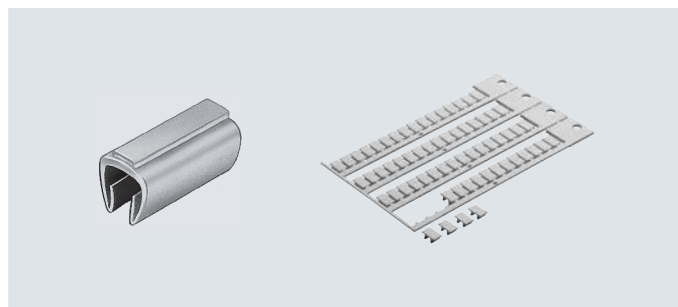

General technical data		KM-BZ	MH	IBS	KMC/F
Type					
Type of mounting		Inscription is pressed onto a cable	Pressed into inscription label holders or suitable slots on the components		
Labelling		The inscription label holder itself is not labelled. The inscription consists of an insertable label or paper/cardboard strips.		By the user directly on the inscription label	
Cable diameter	[mm]	5 ... 8	-		
Product weight	[g]	-	7	-	-

General technical data		ASLR-C-E4	ASLR-D-L1	ASLR-L-423	ASLR-L-55	ASLR-LS6-2016	ASLR-LX4-612-P240
Type							
Designation element		-	-	-	-	-	Device and location identification
Designation element		-	-	-	-	-	Individual mounting
Size		-	-	-	-	-	6x12.5 mm
Design type		-	-	-	-	-	Version X4
Type of mounting		-	-	-	-	-	Can be pressed in manually
Labelling		-	-	-	-	-	Provided by the customer
Labelling area		-	-	-	-	-	4.9 mm x 11.4 mm
Labelling technology		-	-	-	-	-	Printer from PHOENIX CONTACT such as THERMOMARK, BLUEMARK or TOPMARK
Application information		-	-	-	-	-	Printing on frame and as double label possible
Pack size		-	-	-	-	-	240
Information about pack size		-	-	-	-	-	10 frames with 24 pieces each
Product weight	[g]	-	1	-	-	-	0.1

Data sheet





<b>Operating and environmental conditions</b>						
Type	ASLR-C-E4	ASLR-D-L1	ASLR-L-423	ASLR-L-55	ASLR-L-S6-2016	ASLR-L-X4-612-P240
Ambient temperature [°C]	–	–	–	–	–	–40 ... +85
Storage temperature [°C]	–	–	–	–	–	–40 ... +85
Corrosion resistance class CRC <sup>1)</sup>	–	2	4	0	0	–
Fire-tested	–	–	–	UL94 V-2	–	UL94 V-0

- 1) Corrosion resistance class CRC 0 to Festo standard FN 940070  
 No corrosion stress. Applies to small, visually unimportant standards-based parts such as threaded pins, circlips and clamping sleeves which are usually only available on the market in a phosphated or burnished version (and possibly oiled) as well as to ball bearings (for components < CRC 3) and plain bearings.  
 Corrosion resistance class CRC 2 to Festo standard FN 940070  
 Moderate corrosion stress. Indoor applications in which condensation can occur. External visible parts with primarily decorative surface requirements which are in direct contact with a normal industrial environment.  
 Corrosion resistance class CRC 4 to Festo standard FN 940070  
 Particularly high corrosion stress. Outdoor exposure under extreme corrosive conditions. Parts exposed to aggressive media, e.g. in the chemical or food industries. Such applications may need to be safeguarded by means of special testing (→ also FN 940082), using appropriate media.

<b>Materials</b>					
Type	KM-BZ	MH	IBS	IBS-8x20	KMC/F
Label	–	PC	PA	PA	PA
Note on materials	–	–	–	RoHS-compliant	–

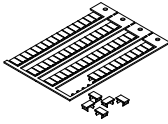
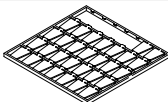
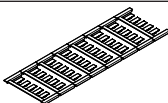
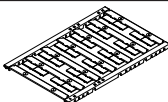
<b>Materials</b>						
Type	ASLR-C-E4	ASLR-D-L1	ASLR-L-423	ASLR-L-55	ASLR-L-S6-2016	ASLR-L-X4-612-P240
Label	–	–	PC	PA	–	PC
Label holder	–	PP	–	–	–	–
Colour	–	–	–	–	–	White
Note on materials	RoHS-compliant	RoHS-compliant	RoHS-compliant	RoHS-compliant	RoHS-compliant	RoHS-compliant
	–	–	Free of copper and PTFE	–	–	–

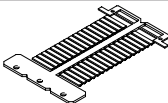
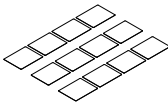
## Data sheet

Ordering data	Description	Dimensions (HxW) [mm]	Scope of delivery	Part no.	Type
	Inscription label for attachment to a cable	11x20	1	<b>33361</b>	<b>KM-BZ</b>
	Inscription label for pressing into a holder	4.5x9	80 (number per frame)	<b>197259</b>	<b>MH-BZ-80X</b>
		6x10	64 (number per frame)	<b>18576</b>	<b>IBS-6x10</b>
		8x20	20 (number per frame)	<b>539388</b>	<b>IBS-8x20</b>
		9x17	24 (number per frame)	<b>161937</b>	<b>IBS-9x17</b>
		9x20	20 (number per frame)	<b>18182</b>	<b>IBS-9x20</b>
	Inscription label for pressing into a holder	11/8x17	35 (number per frame)	<b>33362</b>	<b>KMC/F/V-BZ-35X</b>
	Inscription label for pressing into a holder	6x15	200 pieces	<b>565306</b>	<b>ASLR-C-E4</b>
	Inscription label for pressing into a holder The inscription label is made up of two parts and can be divided into two smaller units if required.	6x12.5	240 pieces	<b>8087174</b>	<b>ASLR-L-X4-612-P240</b>
	Inscription label	–	1000 pieces	<b>574590</b>	<b>ASLR-L-55</b>
	Inscription label for insertion in label holder	4x23	–	<b>541598</b>	<b>ASLR-L-423</b>
	Inscription label, labelled, for sticking (self-adhesive) on the component • 4 inscription labels, duct 1/3/5 • 4 inscription labels, duct 1 • 4 inscription labels, duct 3/5	20x16	3x4 pieces	<b>8003303</b>	<b>ASLR-L-S6-2016</b>
	Holder for an inscription label and covering for the manual override	–	10	<b>570818</b>	<b>ASLR-D-L1</b>

# Festo - Your Partner in Automation



**1 Festo Inc.**  
5300 Explorer Drive  
Mississauga, ON L4W 5G4  
Canada

**Festo Customer Interaction Center**  
Tel: 1 877 463 3786  
Fax: 1 877 393 3786  
Email: [customer.service.ca@festo.com](mailto:customer.service.ca@festo.com)



**2 Festo Pneumatic**  
Av. Ceylán 3,  
Col. Tequesquináhuac  
54020 Tlalnepantla,  
Estado de México

**Multinational Contact Center**  
01 800 337 8669  
[ventas.mexico@festo.com](mailto:ventas.mexico@festo.com)



**3 Festo Corporation**  
1377 Motor Parkway  
Suite 310  
Islandia, NY 11749

**Festo Customer Interaction Center**  
1 800 993 3786  
1 800 963 3786  
[customer.service.us@festo.com](mailto:customer.service.us@festo.com)



**4 Regional Service Center**  
7777 Columbia Road  
Mason, OH 45040

Connect with us



[www.festo.com/socialmedia](http://www.festo.com/socialmedia)



[www.festo.com](http://www.festo.com)

Subject to change