

Compact cylinders ADVUL

FESTO

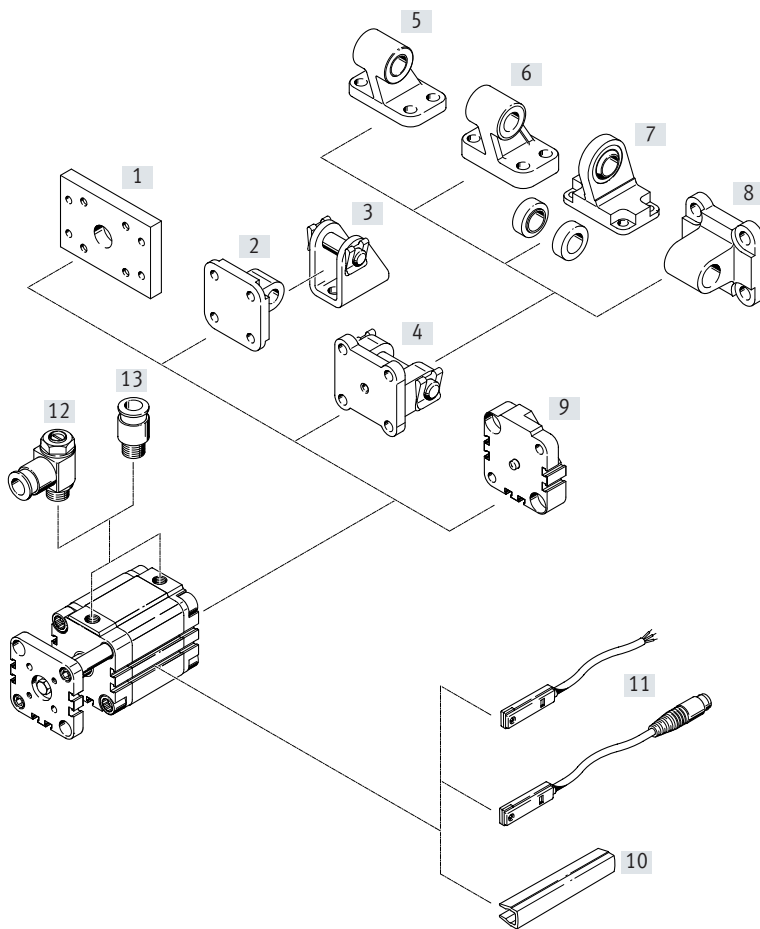

Peripherals overview



Mounting attachments and accessories		Brief description	ADVUL		→ Page/Internet
			ADVUL	S2	
[1]	Flange mounting FUA	For end caps	■	■	11
[2]	Swivel flange SUA for Ø 12 ... 25	For end caps	■	–	12
[3]	Clevis foot LBN	–	■	–	14
[4]	Swivel flange SUA for Ø 32 ... 100	For end caps	■	–	12
[5]	Clevis foot LN	–	■	–	14
[6]	Clevis foot LNG	–	■	–	14
[7]	Clevis foot LSN	With spherical bearing	■	–	14
[8]	Swivel flange SNCL	–	■	–	14
[9]	Mounting kit DPVU	For connecting two cylinders with the same piston diameter to form a multi-position cylinder	■	–	13
[10]	Slot cover ABP-5-S	For protecting the sensor cables and the sensor slots from contamination	■	■	15
[11]	Proximity switch SME/SMT-8	Can be integrated in the cylinder profile barrel	■	■	15
[12]	One-way flow control valve GRLA	For regulating speed	■	■	14
[13]	Push-in fitting QS	For connecting tubing with standard O.D.	■	■	qs

Type codes

001	Series	003	Stroke
ADVUL	Compact cylinder, double-acting, protected against rotation by guide rod and yoke plate	...	1 ... 400
002	Piston diameter	004	Cushioning
12	12	P	Elastic cushioning rings/plates on both sides
16	16	005	Position sensing
20	20	A	For proximity sensor
25	25	006	Piston rod type
32	32		At one end
40	40	S2	Through piston rod
50	50	007	Temperature range
63	63		Standard
80	80	S6	Heat-resistant seals max. 120 °C
100	100		

Data sheet

Function

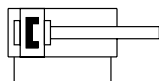

- - Diameter
12 ... 100 mm

- - Stroke length
1 ... 400 mm

www.festo.com
Sets of wearing parts
→ page 10

Variants

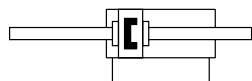

S2

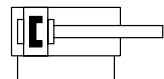

S6



ADVUL-...-P-A



ADVUL-...-P-A-S2

General technical data										
Piston \varnothing	12	16	20	25	32	40	50	63	80	100
Pneumatic connection	M5	M5	M5	M5	G1/8	G1/8	G1/8	G1/8	G1/8	G1/4
Operating medium	Compressed air to ISO 8573-1:2010 [7:4:4]									
Note on the operating/ pilot medium	Lubricated operation possible (in which case lubricated operation will always be required)									
Design	Piston									
	Piston rod									
	Cylinder barrel									
Cushioning	Elastic cushioning rings/pads at both ends									
Position sensing	Via proximity switch									
Type of mounting	Via through-hole									
	With female thread									
	With accessories									
Mounting position	Any									

Operating pressure										
Piston \varnothing	12	16	20	25	32	40	50	63	80	100
Piston rod at one end	[MPa]	0.15 ... 1			0.1 ... 1					
	[bar]	1.5 ... 10			1 ... 10					
	[psi]	21.8 ... 145			14.5 ... 145					
Through piston rod S2	[MPa]	0.15 ... 1			0.1 ... 1					
	[bar]	1.5 ... 10			1 ... 10					
	[psi]	21.8 ... 145			14.5 ... 145					

Environmental conditions		
Compact cylinder	Basic version	S6
Ambient temperature ¹⁾	[°C]	-20 ... +80
Corrosion resistance class CRC ²⁾		2

1) Note operating range of proximity switches

2) Corrosion resistance class CRC 2 to Festo standard FN 940070

Moderate corrosion stress. Indoor applications in which condensation can occur. External visible parts with primarily decorative surface requirements which are in direct contact with a normal industrial environment.

Data sheet

Forces [N] and impact energy [J]		12	16	20	25	32	40	50	63	80	100
Piston \varnothing		12	16	20	25	32	40	50	63	80	100
Theoretical force at 0.6 MPa (6 bar, 87 psi), advancing	S2	68	121	188	295	483	754	1178	1870	3016	4712
Theoretical force at 0.6 MPa (6 bar, 87 psi), retracting	S2	51	90	141	247	415	686	1057	1750	2827	4418
Max. impact energy at the end positions		0.09	0.10	0.14	0.10	0.40	0.52	0.64	0.70	0.75	1.00

Max. lateral force F_q as a function of projection x

Piston rod at one end

Through piston rod

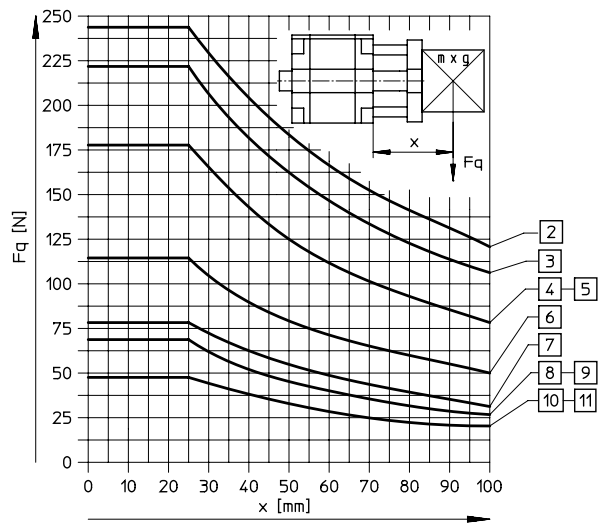
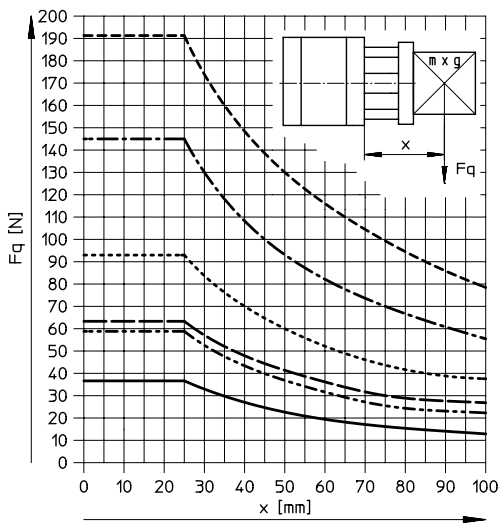

- \varnothing 12, 16
- · - · \varnothing 20, 25
- - - \varnothing 32
- · · · · \varnothing 40
- · - · - \varnothing 50, 63
- - - - - \varnothing 80, 100

- [2] \varnothing 100 mm
- [3] \varnothing 80 mm
- [4] \varnothing 63 mm
- [5] \varnothing 50 mm
- [6] \varnothing 40 mm
- [7] \varnothing 32 mm
- [8] \varnothing 25 mm
- [9] \varnothing 20 mm
- [10] \varnothing 16 mm
- [11] \varnothing 12 mm

Torque M in relation to stroke length L

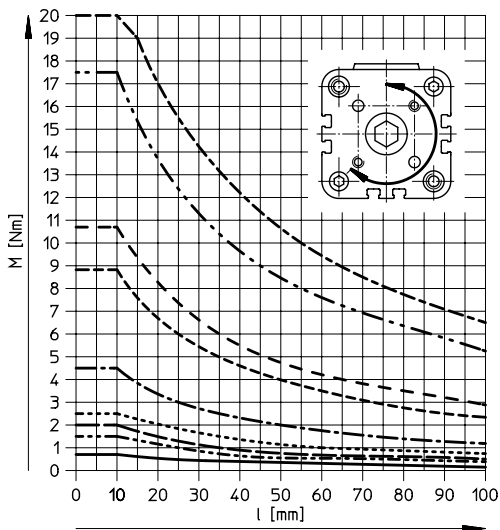

- \varnothing 12, 16
- · - · \varnothing 20
- - - \varnothing 25
- · · · · \varnothing 32
- · - · - \varnothing 40
- - - - - \varnothing 50
- · - · - \varnothing 63
- - - - - \varnothing 80
- · - · - \varnothing 100

Data sheet

Materials

Sectional view

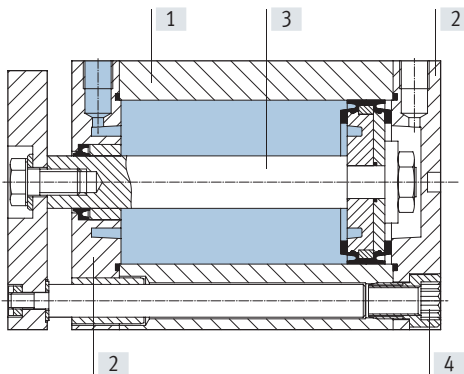

Compact cylinder	Basic version	S6
[1] Cylinder barrel	Wrought aluminium alloy	Wrought aluminium alloy
[2] Bearing and end cap	Wrought aluminium alloy	Wrought aluminium alloy
[3] Piston rod	$\varnothing 12 \dots 32$ High-alloy stainless steel	High-alloy stainless steel
	$\varnothing 40 \dots 100$ High-alloy steel	High-alloy steel
[4] Flange screws	$\varnothing 12 \dots 16$ High-alloy stainless steel	High-alloy stainless steel
	$\varnothing 20 \dots 100$ Tempered steel	Tempered steel
- Seals	Polyurethane, nitrile rubber	Fluoro rubber

Weight [g]	12	16	20	25	32	40	50	63	80	100
Piston \varnothing										
Product weight with 0 mm stroke	100	103	179	215	362	517	707	1252	2150	3316
Additional weight per 10 mm stroke	14	16	26	28	38	45	64	72	97	116
Moving mass with 0 mm stroke	21	26	50	61	111	147	259	327	685	1133
Add. moving mass per 10 mm stroke	4	6	11	11	17	17	29	29	43	43

Data sheet

Dimensions – Basic cylinders

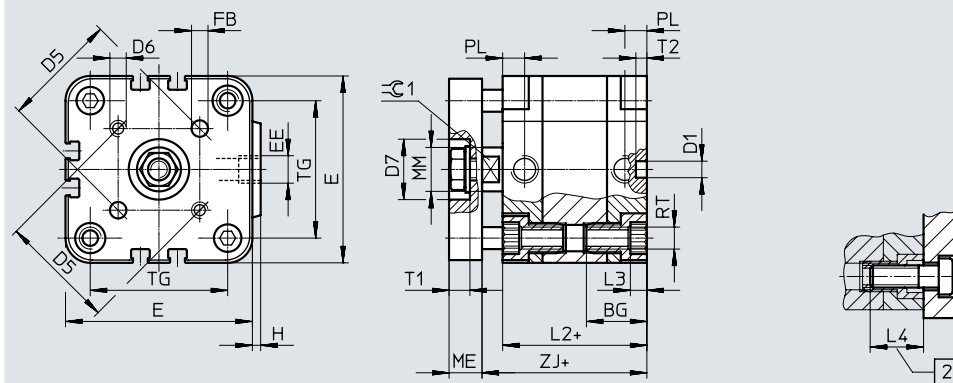
Download CAD data → www.festo.com

[2] Minimum screw-in depth
+ = plus stroke length

∅	BG ¹⁾	D1 ∅ H9	D5	D6	D7 ∅ H9	E	EE	FB ∅ H8	H	L2
12	18.5	6	14	M3	–	29	M5	3	1	38
16	18.5	6	14	M3	–	29	M5	3	1	38
20	18.5	6	17	M4	–	36	M5	4	1.5	38
25	18.5	6	22	M5	14	40	M5	5	1.5	39.5
32	21.5	6	28	M5	17	50	G1/8	5	2	44.5
40	21.5	6	33	M5	17	60	G1/8	5	2.5	45.5
50	22	6	42	M6	22	68	G1/8	6	3	45.5
63	24.5	8	50	M6	22	87	G1/8	6	4	50
80	27.5	8	65	M8	28	107	G1/8	8	4	56
100	32.5	8	80	M10	30	128	G1/4	10	5	66.5

∅	L3	L4	ME	MM ∅	PL	RT	T1 +0.2	T2 –0.2	TG	⊖ h13
12	3	16	6	6	8	M4	–	4	18	5
16	3	16	6	8	8	M4	–	4	18	7
20	4	18	8	10	8	M5	–	4	22	9
25	4	18	8	10	8	M5	4.8	4	26	9
32	5	20	10	12	8	M6	6.1	4	32	10
40	5	20	10	12	8	M6	6.1	4	42	10
50	6	20	12	16	8	M8	7.6	4	50	13
63	8	25	12	16	8	M10	7.6	4	62	13
80	8	25	14	20	8.5	M10	8.7	4	82	17
100	8	25	14	25	10.5	M10	10.3	4	103	22

1) Do not exceed screw-in depth

Data sheet

Dimensions – Variants

Download CAD data → www.festo.com

Piston rod at one end

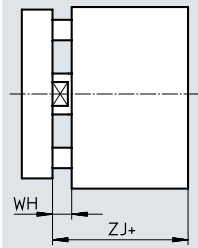

Through piston rod

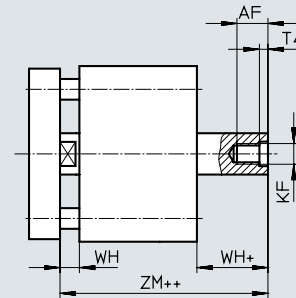

- + = plus stroke length
- ++ = plus 2x stroke length

∅	AF	KF	T4	WH	ZJ	ZM
[mm]						
12	8	M3	1.5	4.5	42.5	47
16	10	M4	1.5	4.5	42.5	47
20	12	M5	2	4.5	42.5	47
25	12	M5	2	5.5	45	50.5
32	14	M6	2.6	6	50.5	56.5
40	14	M6	2.6	6.5	52	58.5
50	16	M8	3.3	7.5	53	60.5
63	16	M8	3.3	7.5	57.5	65
80	20 ¹⁾	M10	4.7	8	64	72
100	24 ¹⁾	M12	6.1	10	76.5	86.5

1) With a stroke < 5 mm, the maximum screw-in depth is reduced by 5 mm

Data sheet

Ordering data – Basic design					
Stroke [mm]	Part no.	Type	Stroke [mm]	Part no.	Type
Piston ø 12 mm			Piston ø 16 mm		
5	156844	ADVUL-12-5-P-A	5	156851	ADVUL-16-5-P-A
10	156845	ADVUL-12-10-P-A	10	156852	ADVUL-16-10-P-A
15	156846	ADVUL-12-15-P-A	15	156853	ADVUL-16-15-P-A
20	156847	ADVUL-12-20-P-A	20	156854	ADVUL-16-20-P-A
25	156848	ADVUL-12-25-P-A	25	156855	ADVUL-16-25-P-A
30	156849	ADVUL-12-30-P-A	30	156856	ADVUL-16-30-P-A
40	156850	ADVUL-12-40-P-A	40	156857	ADVUL-16-40-P-A
Piston ø 20 mm			Piston ø 25 mm		
5	156858	ADVUL-20-5-P-A	5	156866	ADVUL-25-5-P-A
10	156859	ADVUL-20-10-P-A	10	156867	ADVUL-25-10-P-A
15	156860	ADVUL-20-15-P-A	15	156868	ADVUL-25-15-P-A
20	156861	ADVUL-20-20-P-A	20	156869	ADVUL-25-20-P-A
25	156862	ADVUL-20-25-P-A	25	156870	ADVUL-25-25-P-A
30	156863	ADVUL-20-30-P-A	30	156871	ADVUL-25-30-P-A
40	156864	ADVUL-20-40-P-A	40	156872	ADVUL-25-40-P-A
50	156865	ADVUL-20-50-P-A	50	156873	ADVUL-25-50-P-A
Piston ø 32 mm			Piston ø 40 mm		
5	156874	ADVUL-32-5-P-A	5	156884	ADVUL-40-5-P-A
10	156875	ADVUL-32-10-P-A	10	156885	ADVUL-40-10-P-A
15	156876	ADVUL-32-15-P-A	15	156886	ADVUL-40-15-P-A
20	156877	ADVUL-32-20-P-A	20	156887	ADVUL-40-20-P-A
25	156878	ADVUL-32-25-P-A	25	156888	ADVUL-40-25-P-A
30	156879	ADVUL-32-30-P-A	30	156889	ADVUL-40-30-P-A
40	156880	ADVUL-32-40-P-A	40	156890	ADVUL-40-40-P-A
50	156881	ADVUL-32-50-P-A	50	156891	ADVUL-40-50-P-A
60	156882	ADVUL-32-60-P-A	60	156892	ADVUL-40-60-P-A
80	156883	ADVUL-32-80-P-A	80	156893	ADVUL-40-80-P-A
Piston ø 50 mm			Piston ø 63 mm		
10	156894	ADVUL-50-10-P-A	10	156903	ADVUL-63-10-P-A
15	156895	ADVUL-50-15-P-A	15	156904	ADVUL-63-15-P-A
20	156896	ADVUL-50-20-P-A	20	156905	ADVUL-63-20-P-A
25	156897	ADVUL-50-25-P-A	25	156906	ADVUL-63-25-P-A
30	156898	ADVUL-50-30-P-A	30	156907	ADVUL-63-30-P-A
40	156899	ADVUL-50-40-P-A	40	156908	ADVUL-63-40-P-A
50	156900	ADVUL-50-50-P-A	50	156909	ADVUL-63-50-P-A
60	156901	ADVUL-50-60-P-A	60	156910	ADVUL-63-60-P-A
80	156902	ADVUL-50-80-P-A	80	156911	ADVUL-63-80-P-A
Piston ø 80 mm			Piston ø 100 mm		
10	156912	ADVUL-80-10-P-A	10	156921	ADVUL-100-10-P-A
15	156913	ADVUL-80-15-P-A	15	156922	ADVUL-100-15-P-A
20	156914	ADVUL-80-20-P-A	20	156923	ADVUL-100-20-P-A
25	156915	ADVUL-80-25-P-A	25	156924	ADVUL-100-25-P-A
30	156916	ADVUL-80-30-P-A	30	156925	ADVUL-100-30-P-A
40	156917	ADVUL-80-40-P-A	40	156926	ADVUL-100-40-P-A
50	156918	ADVUL-80-50-P-A	50	156927	ADVUL-100-50-P-A
60	156919	ADVUL-80-60-P-A	60	156928	ADVUL-100-60-P-A
80	156920	ADVUL-80-80-P-A	80	156929	ADVUL-100-80-P-A

Data sheet

Ordering data – Variants			
Piston ø [mm]	Stroke [mm]	Part no.	Type
Variable stroke			
12	1 ... 200	156200	ADVUL-12-...-P-A
16	1 ... 200	156201	ADVUL-16-...-P-A
20	1 ... 200	156202	ADVUL-20-...-P-A
25	1 ... 200	156203	ADVUL-25-...-P-A
32	1 ... 300	156204	ADVUL-32-...-P-A
40	1 ... 300	156205	ADVUL-40-...-P-A
50	1 ... 300	156206	ADVUL-50-...-P-A
63	1 ... 300	156207	ADVUL-63-...-P-A
80	1 ... 400	156208	ADVUL-80-...-P-A
100	1 ... 400	156209	ADVUL-100-...-P-A
S2 – Through piston rod, variable stroke			
12	1 ... 200	165089	ADVUL-12-...-P-A-S2
16	1 ... 200	165090	ADVUL-16-...-P-A-S2
20	1 ... 200	165091	ADVUL-20-...-P-A-S2
25	1 ... 200	165092	ADVUL-25-...-P-A-S2
32	1 ... 300	165093	ADVUL-32-...-P-A-S2
40	1 ... 300	165094	ADVUL-40-...-P-A-S2
50	1 ... 300	165095	ADVUL-50-...-P-A-S2
63	1 ... 300	165096	ADVUL-63-...-P-A-S2
80	1 ... 400	165097	ADVUL-80-...-P-A-S2
100	1 ... 400	165098	ADVUL-100-...-P-A-S2

Ordering data – Variants			
Piston ø [mm]	Stroke [mm]	Part no.	Type
S6 – Heat-resistant up to 120°C, variable stroke			
12	1 ... 200	156210	ADVUL-12-...-P-A-S6
16	1 ... 200	156211	ADVUL-16-...-P-A-S6
20	1 ... 200	156212	ADVUL-20-...-P-A-S6
25	1 ... 200	156213	ADVUL-25-...-P-A-S6
32	1 ... 300	156214	ADVUL-32-...-P-A-S6
40	1 ... 300	156215	ADVUL-40-...-P-A-S6
50	1 ... 300	156216	ADVUL-50-...-P-A-S6
63	1 ... 300	156217	ADVUL-63-...-P-A-S6
80	1 ... 400	156218	ADVUL-80-...-P-A-S6
100	1 ... 400	156219	ADVUL-100-...-P-A-S6

Ordering data – Sets of wearing parts				
Piston ø	Part no.	Type	Part no.	Type
	Basic version		S6 – Heat-resistant up to 120°C	
12	121115	ADVUL-12-...-P-A ¹⁾	383559	ADVUL-12-...-P-A-S6 ²⁾
16	121116	ADVUL-16-...-P-A ¹⁾	383560	ADVUL-16-...-P-A-S6 ²⁾
20	121117	ADVUL-20-...-P-A ¹⁾	383561	ADVUL-20-...-P-A-S6 ²⁾
25	121118	ADVUL-25-...-P-A ¹⁾	383562	ADVUL-25-...-P-A-S6 ²⁾
32	121119	ADVUL-32-...-P-A ¹⁾	383563	ADVUL-32-...-P-A-S6 ¹⁾
40	121120	ADVUL-40-...-P-A ¹⁾	383564	ADVUL-40-...-P-A-S6 ¹⁾
50	121121	ADVUL-50-...-P-A ¹⁾	383565	ADVUL-50-...-P-A-S6 ¹⁾
63	121122	ADVUL-63-...-P-A ¹⁾	383566	ADVUL-63-...-P-A-S6 ¹⁾
80	121123	ADVUL-80-...-P-A ¹⁾	383567	ADVUL-80-...-P-A-S6 ¹⁾
100	121124	ADVUL-100-...-P-A ¹⁾	383568	ADVUL-100-...-P-A-S6 ¹⁾

1) Assembly grease included in the scope of delivery
 2) Assembly grease not included in scope of delivery. If required, please order separately under part no. 329 555 (20 ml)

Accessories

Flange mounting FUA

Material:
Colourless anodised wrought
aluminium alloy
RoHS-compliant

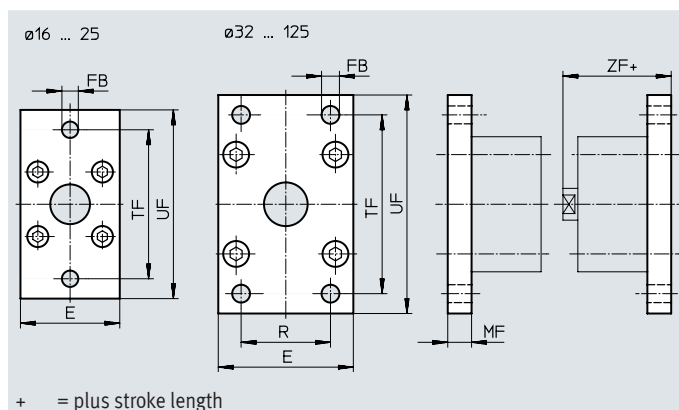

Dimensions and ordering data

For \varnothing [mm]	E	FB \varnothing	MF	R	TF	UF	ZF	CRC ¹⁾	Weight [g]	Part no.	Type
12/16	29	5.5	10	–	43	55	52.5	2	48	157299	FUA-12/16
20	36	6.6	10	–	55	70	52.5	2	77	157300	FUA-20
25	40	6.6	10	–	60	76	55	2	91	157301	FUA-25
32	50	7	10	32	65	80	60.5	2	290	157302	FUA-32
40	60	9	10	36	82	102	62	2	449	157303	FUA-40
50	68	9	12	45	90	110	65	2	658	157304	FUA-50
63	87	9	15	50	110	130	72.5	2	1277	157305	FUA-63
80	107	12	15	63	135	160	76	2	1910	157306	FUA-80
100	128	14	15	75	163	190	91.5	2	2716	157307	FUA-100

1) Corrosion resistance class CRC 2 to Festo standard FN 940070

Moderate corrosion stress. Indoor applications in which condensation can occur. External visible parts with primarily decorative surface requirements which are in direct contact with a normal industrial environment.

Accessories

Swivel flange SUA

For piston \varnothing 12 ... 25 mm

Material:

Anodised aluminium

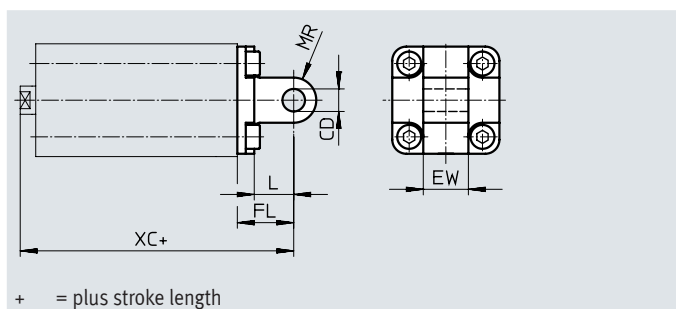

For piston \varnothing 32 ... 100 mm

Material:

Anodised aluminium

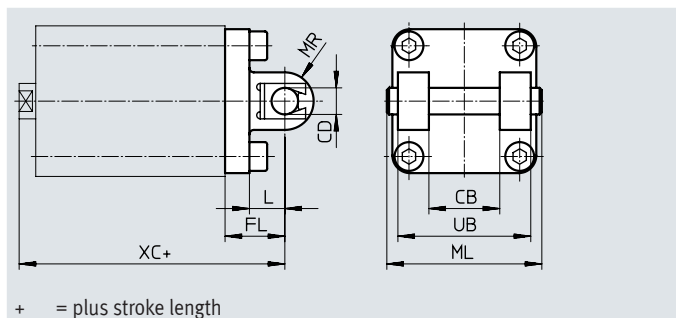

Dimensions and ordering data

For \varnothing [mm]	CB	CD \varnothing	EW	FL	L	ML	MR	UB	XC	Weight [g]	Part no.	Type
12/16	-	6	12	16	10	-	6	-	58.5	22	157319	SUA-12/16
20	-	8	16	20	14	-	8	-	62.5	41	157320	SUA-20
25	-	8	16	20	14	-	8	-	64	45	157321	SUA-25
32	26	10	-	22	13	54	10	45	72.5	137	157322	SUA-32
40	28	12	-	25	16	62	12	52	77	199	157323	SUA-40
50	32	12	-	27	16	70	12	60	80	287	157324	SUA-50
63	40	16	-	32	21	82	16	70	89.5	530	157325	SUA-63
80	50	16	-	36	23	102	16	90	100	770	157326	SUA-80
100	60	20	-	41	26	126	20	110	117.5	1283	157327	SUA-100

Note

The maximum stroke length must not be exceeded when combining cylinders and swivel flanges.

For \varnothing	Max. stroke length [mm]
12	50
16	50
20	50
25	50
32	100

For \varnothing	Max. stroke length [mm]
40	100
50	100
63	100
80	150
100	150

Accessories

Multi-position kit DPVU

Material:
Wrought aluminium alloy

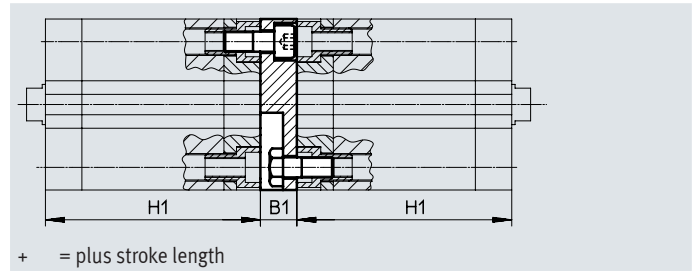

Dimensions and ordering data								
For \varnothing	B1	H	Max. overall stroke length [mm]	CRC ¹⁾	Weight [g]	Part no.	Type	
12/16	12.5	38	400	2	35	161194	DPVU-12/16	
20	12.5	38			54	161195	DPVU-20	
25	13	39.5			65	161196	DPVU-25	
32	14.5	44.5	600		111	161197	DPVU-32	
40	14.5	45.5			155	161198	DPVU-40	
50	14.5	45.5			212	161199	DPVU-50	
63	14.5	50			372	161200	DPVU-63	
80	16.5	56	800		580	161201	DPVU-80	
100	19.5	66.5			935	161202	DPVU-100	

Note
The maximum total stroke length must not be exceeded when combining cylinders and multi-position kits.

1) Corrosion resistance class CRC 2 to Festo standard FN 940070
Moderate corrosion stress. Indoor applications in which condensation can occur. External visible parts with primarily decorative surface requirements which are in direct contact with a normal industrial environment.

Connecting two cylinders with identical piston diameters to form a 3- or 4-position cylinder

A 3- or 4-position cylinder consists of two separate cylinders whose piston rods advance in opposing directions. This means that depending on actuation and stroke division, this type of cylinder can assume up to four positions. In each case the cylinder is driven precisely against a stop.

Note that when one end of the piston rod is fixed, the cylinder barrel executes the movement. The connections to the cylinder must therefore be flexible.

To achieve 3 positions

Two cylinders with the same stroke length must be connected together.

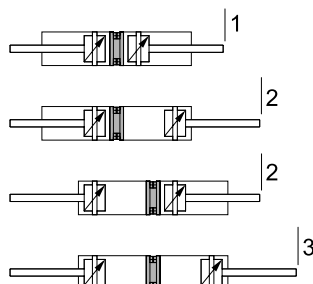

To achieve 4 positions

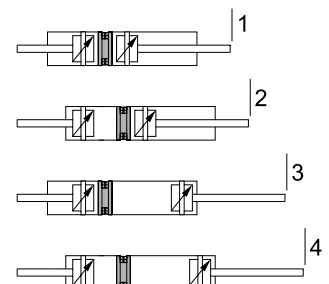

Two cylinders with different stroke lengths must be connected together.



Accessories

Ordering data – Mounting components

Data sheets → Internet: clevis foot

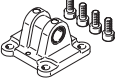
Designation	For ø	Part no.	Type
Clevis foot LBN			
	12	6058	LBN-12/16
	16	6058	LBN-12/16
	20	6059	LBN-20/25
	25	6059	LBN-20/25
Clevis foot LN			
	32	5147	LN-32
	40	5148	LN-40
	50	5149	LN-50
	63	5150	LN-63
	80	5151	LN-80
	100	5152	LN-100
Swivel flange SNCL			
	32	174404	SNCL-32
	40	174405	SNCL-40
	50	174406	SNCL-50
	63	174407	SNCL-63
	80	174408	SNCL-80
	100	174409	SNCL-100

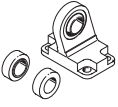







Designation	For ø	Part no.	Type
Clevis foot LNG			
	32	33890	LNG-32
	40	33891	LNG-40
	50	33892	LNG-50
	63	33893	LNG-63
	80	33894	LNG-80
	100	33895	LNG-100
Clevis foot LSN			
	32	5561	LSN-32
	40	5562	LSN-40
	50	5563	LSN-50
	63	5564	LSN-63
	80	5565	LSN-80
	100	5566	LSN-100

Ordering data – One-way flow control valves

Data sheets → Internet: grl

	Connection		Material	Part no.	Type
	Thread	For tubing O.D.			
	M5	3	Metal design	193137	GRLA-M5-QS-3-D
		4		193138	GRLA-M5-QS-4-D
		6		193139	GRLA-M5-QS-6-D
	G1/8	3		193142	GRLA-1/8-QS-3-D
		4		193143	GRLA-1/8-QS-4-D
		6		193144	GRLA-1/8-QS-6-D
		8		193145	GRLA-1/8-QS-8-D
		10		193146	GRLA-1/4-QS-6-D
	G1/4	6		193147	GRLA-1/4-QS-8-D
		8		193148	GRLA-1/4-QS-10-D
		10			

Accessories

Ordering data – Proximity switch for T-slot, magneto-resistive						Data sheets → Internet: smt	
	Type of mounting	Switching output	Electrical connection	Cable length [m]	Part no.	Type	
N/O							
	Inserted in the slot from above, flush with the cylinder profile, short design	PNP	Cable, 3-wire	2.5	574335	SMT-8M-A-PS-24V-E-2.5-OE	
			Plug M8x1, 3-pin	0.3	574334	SMT-8M-A-PS-24V-E-0.3-M8D	
			Plug M12x1, 3-pin	0.3	574337	SMT-8M-A-PS-24V-E-0.3-M12	
		NPN	Cable, 3-wire	2.5	574338	SMT-8M-A-NS-24V-E-2.5-OE	
			Plug M8x1, 3-pin	0.3	574339	SMT-8M-A-NS-24V-E-0.3-M8D	
N/C contact							
	Inserted in the slot from above, flush with the cylinder profile, short design	PNP	Cable, 3-wire	7.5	574340	SMT-8M-A-PO-24V-E-7.5-OE	
Ordering data – Proximity switch for T-slot, magnetic reed						Data sheets → Internet: sme	
	Type of mounting	Switching output	Electrical connection	Cable length [m]	Part no.	Type	
N/O							
	Inserted in the slot from above, flush with the cylinder profile	Contacting	Cable, 3-wire	2.5	543862	SME-8M-DS-24V-K-2.5-OE	
				5.0	543863	SME-8M-DS-24V-K-5.0-OE	
			Plug M8x1, 3-pin	Cable, 2-wire	2.5	543872	SME-8M-ZS-24V-K-2.5-OE
				0.3	543861	SME-8M-DS-24V-K-0.3-M8D	
	Inserted in the slot lengthwise, flush with the cylinder profile	Contacting	Plug M8x1, 3-pin	Cable, 3-wire	2.5	150855	SME-8-K-LED-24
				0.3	150857	SME-8-S-LED-24	
N/C contact							
	Inserted in the slot lengthwise, flush with the cylinder profile	Contacting	Cable, 3-wire	7.5	160251	SME-8-O-K-LED-24	
Ordering data – Connecting cables						Data sheets → Internet: nebu	
	Electrical connection, left	Electrical connection, right	Cable length [m]	Part no.	Type		
	Straight socket, M8x1, 3-pin	Cable, open end, 3-wire	2.5	541333	NEBU-M8G3-K-2.5-LE3		
			5.0	541334	NEBU-M8G3-K-5-LE3		
	Straight socket, M12x1, 5-pin	Cable, open end, 3-wire	2.5	541363	NEBU-M12G5-K-2.5-LE3		
			5.0	541364	NEBU-M12G5-K-5-LE3		
	Angled socket, M8x1, 3-pin	Cable, open end, 3-wire	2.5	541338	NEBU-M8W3-K-2.5-LE3		
			5.0	541341	NEBU-M8W3-K-5-LE3		
	Angled socket, M12x1, 5-pin	Cable, open end, 3-wire	2.5	541367	NEBU-M12W5-K-2.5-LE3		
			5.0	541370	NEBU-M12W5-K-5-LE3		
Ordering data – Slot cover for T-slot							
	Mounting	Length	Part no.	Type			
	Insertable	2x 0.5 m	151680	ABP-5-S			

Festo - Your Partner in Automation



1 Festo Inc.
5300 Explorer Drive
Mississauga, ON L4W 5G4
Canada

Festo Customer Interaction Center
Tel: 1 877 463 3786
Fax: 1 877 393 3786
Email: customer.service.ca@festo.com



2 Festo Pneumatic
Av. Ceylán 3,
Col. Tequesquináhuac
54020 Tlalnepantla,
Estado de México

Multinational Contact Center
01 800 337 8669
ventas.mexico@festo.com



3 Festo Corporation
1377 Motor Parkway
Suite 310
Islandia, NY 11749

Festo Customer Interaction Center
1 800 993 3786
1 800 963 3786
customer.service.us@festo.com



4 Regional Service Center
7777 Columbia Road
Mason, OH 45040

Connect with us



www.festo.com/socialmedia



www.festo.com

Subject to change