

## Adapter for grippers

**FESTO**



Accessories



Adapter kit  
HAPG, HMSV

Material:  
Wrought aluminium alloy  
RoHS-compliant

 **Note**  
The kit includes the individual mounting interface as well as the necessary mounting material.

Permissible drive/gripper combinations with adapter kit

Download CAD data → [www.festo.com](http://www.festo.com)

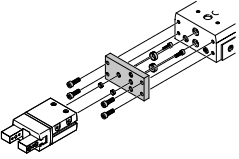
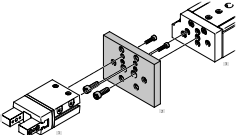
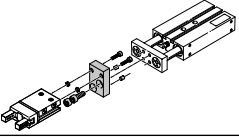
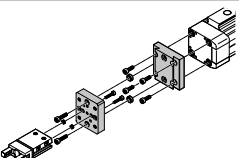
Combination	Drive Size	Gripper Size	Mounting option		Adapter kit		
					CRC <sup>1)</sup>	Part no.	Type
<b>DGST/DHPS</b>	<b>DGST</b>	<b>DHPS</b>			<b>DHAA</b>		
	6	6	■	■	2	8161981	DHAA-G-G8-6-B18-6
	8	6	■	■		8161977	DHAA-G-G8-8-B18-6
	10	10	■	■		8161979	DHAA-G-G8-10-B18-10
	12	10	■	■		8161978	DHAA-G-G8-12-B18-10
	16	16	■	■		8161980	DHAA-G-G8-16-B18-16
	20	20	■	■		8161976	DHAA-G-G8-20-B18-20
	25	25	■	■		8161975	DHAA-G-G8-25-B18-25
<b>DGSL/DHPS</b>	<b>DGSL</b>	<b>DHPS</b>			<b>HMSV</b>		
	4, 6	6	■	■	2	548783	HMSV-53
	8, 10	10	■	■		548784	HMSV-54
	12, 16	16	■	■		548785	HMSV-55
	20, 25	20, 25	■	■		548786	HMSV-56
<b>DPZ/DHPS</b>	<b>DPZ</b>	<b>DHPS</b>			<b>HAPG</b>		
	10, 16	10	■	–	2	163250	HAPG-1
	16	16, 20	■	–		163251	HAPG-2
	20	16, 20	■	–		163252	HAPG-3
	25, 32	25	■	–		163253	HAPG-4
<b>DGPL/DHPS</b>	<b>DGPL</b>	<b>DHPS</b>			<b>HMVA, HAPG, HMSV</b>		
	<b>Direct mounting</b>				2		
	25, 32	6	■	■		196788	HMVA-DLA1 8/25
						192706	HAPG-37-S1
	40	6	■	■		196790	HMVA-DLA40
						192706	HAPG-37-S1
	25, 32	10	■	■		196788	HMVA-DLA1 8/25
						192705	HAPG-36-S1
	40	10	■	■		196790	HMVA-DLA40
						192705	HAPG-36-S1
	25, 32	16	■	■		196788	HMVA-DLA1 8/25
				193922	HAPG-37-S4		
40	16	■	■	196790	HMVA-DLA40		
				193922	HAPG-37-S4		

1) More information: [www.festo.com/x/topic/crc](http://www.festo.com/x/topic/crc)



## Accessories

Adapter kit  
DHAA, HAPG

Material:  
Wrought aluminium alloy  
RoHS-compliant

 **Note**

The kit includes the individual mounting interface as well as the necessary mounting material.

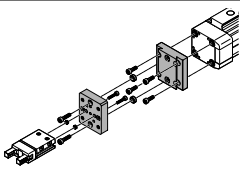
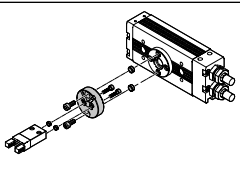
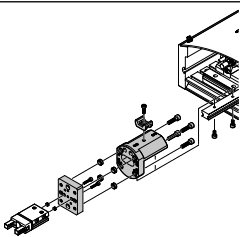
Permissible drive/gripper combinations with adapter kit							Download CAD data → <a href="http://www.festo.com">www.festo.com</a>	
Combination	Drive Size	Gripper Size	Mounting option		Adapter kit CRC <sup>1)</sup>	Part no.	Type	
								
<b>DGPL/DHPS</b>	<b>DGPL</b>	<b>DHPS</b>			<b>HMVA, HAPG, HMSV</b>			
	<b>Dovetail mounting</b>							
	25	10	■	■	2	196788	HMVA-DLA18/25	
						177767	HMSV-27	
	40	10	■	■		196790	HMVA-DLA40	
						177767	HMSV-27	
	25	16	■	■		196788	HMVA-DLA18/25	
						177768	HMSV-28	
	40	16	■	■		196790	HMVA-DLA40	
				177768		HMSV-28		
40	25	■	■	196790	HMVA-DLA40			
				177769	HMSV-29			
40	35	■	■	196790	HMVA-DLA40			
				177770	HMSV-30			
<b>DRRD/DHPS</b>	<b>DRRD</b>	<b>DHPS</b>			<b>DHAA</b>			
	8	6	■	■	2	2808892	DHAA-G-Q11-8-B1-6	
	10	6	■	■		2807644	DHAA-G-Q11-10-B1-6	
	12	6	■	■		2805783	DHAA-G-Q11-12-B1-6	
	12	10	■	■		2802687	DHAA-G-Q11-12-B1-10	
	16	10	■	■		2190504	DHAA-G-Q11-16-B1-10	
	16	16	■	■		2190393	DHAA-G-Q11-16-B1-16	
	16	20	■	■		2187838	DHAA-G-Q11-16-B1-20	
	20	16	■	■		2190284	DHAA-G-Q11-20-B1-16	
	20	20	■	■		2187713	DHAA-G-Q11-20-B1-20	
	20	25	■	■		2185820	DHAA-G-Q11-20-B1-25	
	25	16	■	■		1471634	DHAA-G-Q11-25-B1-16	
	25	20	■	■		1722652	DHAA-G-Q11-25-B1-20	
	25	25	■	■		1725707	DHAA-G-Q11-25-B1-25	
	32	25	■	■		2186909	DHAA-G-Q11-32-B1-25	
	32	35	■	■		2187316	DHAA-G-Q11-32-B1-35	
	35, 40	35	■	■		2187606	DHAA-G-Q11-35/40-B1-35	
<b>HSP/DHPS</b>	<b>HSP</b>	<b>DHPS</b>			<b>HAPG</b>			
	12	6	■	–	2	192709	HAPG-60-S1	
						540881	HAPG-70-B	
	16	6	■	–		192706	HAPG-37-S1	
						540882	HAPG-71-B	
	16	10	■	–		192705	HAPG-36-S1	
						540882	HAPG-71-B	
	25	10	■	–		192705	HAPG-36-S1	
						540883	HAPG-72-B	
25	16	■	–	193922	HAPG-37-S4			
				540883	HAPG-72-B			

1) More information: [www.festo.com/x/topic/crc](http://www.festo.com/x/topic/crc)

# Adapter for parallel gripper DHPS

## Accessories



**Adapter kit**  
DHAA, HAPG

Material:  
Wrought aluminium alloy  
RoHS-compliant

 **Note**  
The kit includes the individual mounting interface as well as the necessary mounting material.

**Permissible drive/gripper combinations with adapter kit**

Download CAD data → [www.festo.com](http://www.festo.com)

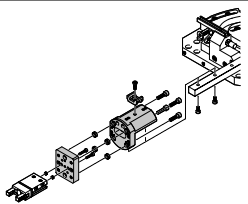
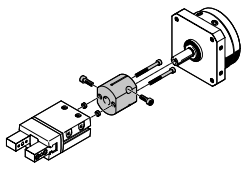
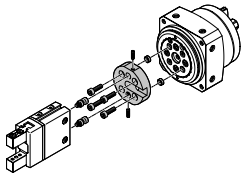
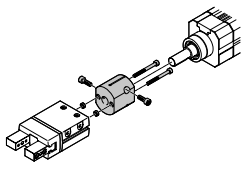
Combination	Drive Size	Gripper Size	Mounting option		Adapter kit		
					CRC <sup>1)</sup>	Part no.	Type
	12, 16	6	■	–	2	192706	HAPG-37-S1
			■	–		540882	HAPG-71-B
	12, 16	10	■	–		192705	HAPG-36-S1
			■	–		540882	HAPG-71-B
	6, 8, 10	6	■	■	2	187568	HAPG-34
	DSM-...	DHPS	■	■	2	163266	HAPG-17
						163267	HAPG-18
						163268	HAPG-19
						163269	HAPG-20
						163270	HAPG-21
						163271	HAPG-22
	DSM-...-HD	DHPS	■	■		2	8071899
					8072157		DHAA-G-R3-12-B18-10
					8071917		DHAA-G-R3-16-B18-10
					8079173		DHAA-G-R3-16-B18-16
					8071956		DHAA-G-R3-25-B18-16
					8079208		DHAA-G-R3-32-B18-25
							DSL
163267	HAPG-18						
163268	HAPG-19						
163269	HAPG-20						
163270	HAPG-21						
163271	HAPG-22						

1) More information: [www.festo.com/x/topic/crc](http://www.festo.com/x/topic/crc)



## Accessories

**Adapter kit**  
DHAA, HAPG, HMSV

Material:  
Wrought aluminium alloy  
RoHS-compliant

 **Note**

The kit includes the individual mounting interface as well as the necessary mounting material.

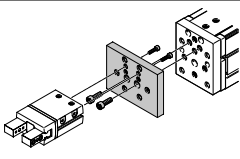
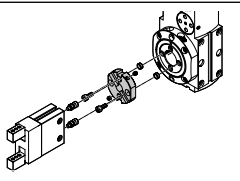
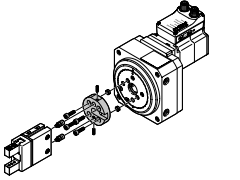
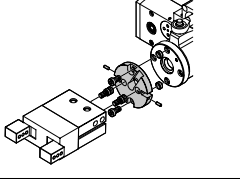
Permissible drive/gripper combinations with adapter kit						Download CAD data → <a href="http://www.festo.com">www.festo.com</a>	
Combination	Drive Size	Gripper Size	Mounting option		Adapter kit CRC <sup>1)</sup>	Part no.	Type
							
<b>EGSL/DHPS</b>	<b>EGSL</b>	<b>DHPS</b>			<b>HMSV</b>		
	35	6	■	■	2	548783	HMSV-53
	35	10	■	■		1088262	HMSV-70
	45, 55	16	■	■		548784	HMSV-54
	75	20, 25	■	■		1088262	HMSV-70
						548785	HMSV-55
						548786	HMSV-56
<b>ERMB/DHPS</b>	<b>ERMB</b>	<b>DHPS</b>			<b>HAPG</b>		
	20	16, 20	■	■	2	184479	HAPG-SD2-3
	25	16, 20	■	■		184482	HAPG-SD2-6
	20	25	■	■		184480	HAPG-SD2-4
	25	25	■	■		184483	HAPG-SD2-7
	32	25	■	■		184485	HAPG-SD2-9
	32	35	■	■		184486	HAPG-SD2-10
<b>ERMO/DHPS</b>	<b>ERMO</b>	<b>DHPS</b>			<b>DHAA</b>		
	12	6	■	■	2	8071899	DHAA-G-R3-12-B18-6
	12	10	■	■		8072157	DHAA-G-R3-12-B18-10
	16	10	■	■		8071917	DHAA-G-R3-16-B18-10
	16	16	■	■		8079173	DHAA-G-R3-16-B18-16
	25	16, 20	■	■		8071956	DHAA-G-R3-25-B18-16
	32	25	■	■		8079208	DHAA-G-R3-32-B18-25
<b>EHMB/DHPS</b>	<b>EHMB</b>	<b>DHPS</b>			<b>HAPG</b>		
	20	25	■	■	2	184485	HAPG-SD2-9
	20	35	■	■		184486	HAPG-SD2-10
	25, 32	35	■	■		526027	HAPG-SD2-21

1) More information: [www.festo.com/x/topic/crc](http://www.festo.com/x/topic/crc)

# Adapter for parallel gripper HGPD, sealed

## Accessories



**Adapter kit**  
**DHAA**

Material:  
Wrought aluminium alloy  
RoHS-compliant

 **Note**  
The kit includes the individual mounting interface as well as the necessary mounting material.

### Permissible drive/gripper combinations with adapter kit

Download CAD data → [www.festo.com](http://www.festo.com)

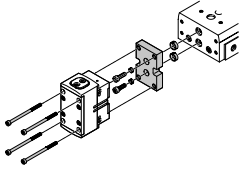
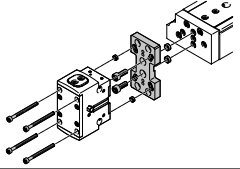
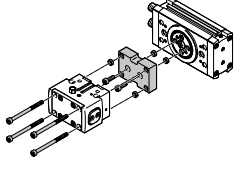
Combination	Drive Size	Gripper Size	Mounting option		Adapter kit CRC <sup>1)</sup>	Part no.	Type
							
<b>DGST/HGPD</b>	<b>DGST</b>	<b>HGPD</b>			<b>DHAA</b>		
	10	16	–	■	2	8163132	DHAA-G-G8-10-B12-16
	12	20	–	■		8163129	DHAA-G-G8-12-B12-20
	16	25	–	■		8163133	DHAA-G-G8-16-B12-25
	20	35	–	■		8163131	DHAA-G-G8-20-B12-35
	25	40	–	■		8163130	DHAA-G-G8-25-B12-40
<b>DGSL/HGPD</b>	<b>DGSL</b>	<b>HGPD</b>			<b>DHAA, HAPG</b>		
	8, 10	16, 20	■	■	2	564957	DHAA-G-G6-8-B8-16
	12, 16	16, 20	■	■		564954	DHAA-G-G6-16-B8-16
	12, 16	25	■	■		564952	DHAA-G-G6-16-B8-25
	20, 25	25, 35	■	■		537175	HAPG-79
	20, 25	40	■	■		564951	DHAA-G-G6-20-B8-40
<b>DRRD/HGPD</b>	<b>DRRD</b>	<b>HGPD</b>			<b>DHAA</b>		
	12	16	■	■	2	2449935	DHAA-G-Q11-12-B12-16
	12	20	■	■		2449945	DHAA-G-Q11-12-B12-20
	16	16	■	■		2091914	DHAA-G-Q11-16-B12/B12G-16
	16	20	■	■		2091205	DHAA-G-Q11-16-B12-20
	16	25	■	■		2090715	DHAA-G-Q11-16-B12-25
	20	25	■	■		2088381	DHAA-G-Q11-20-B12-25
	20	35	■	■		2088008	DHAA-G-Q11-20-B12-35
	25	35	■	■		1714646	DHAA-G-Q11-25-B12-35
	25	40	■	■		1715576	DHAA-G-Q11-25-B12-40
	32	40	■	■		2092197	DHAA-G-Q11-32-B12-40
	35	40	■	■		2114998	DHAA-G-Q11-35-B12-40
	32	50	■	■		2124051	DHAA-G-Q11-32-B12-50
	35, 40	50	■	■		2124346	DHAA-G-Q11-35/40-B12-50
	40	63	■	■		2125614	DHAA-G-Q11-40-B12-63
	50	63	■	■		2352692	DHAA-G-Q11-50-B12-63
50	80	■	■	2412840	DHAA-G-Q11-50-B12-80		



1) More information: [www.festo.com/x/topic/crc](http://www.festo.com/x/topic/crc)

## Accessories

**Adapter kit**  
DHAA, HAPG

Material:  
Wrought aluminium alloy  
RoHS-compliant

 **Note**  
The kit includes the individual mounting interface as well as the necessary mounting material.

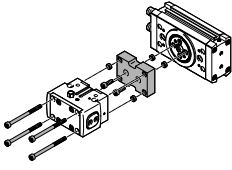
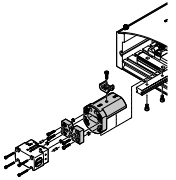
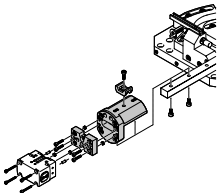
Permissible drive/gripper combinations with adapter kit					Download CAD data → <a href="http://www.festo.com">www.festo.com</a>		
Combination	Drive Size	Gripper Size	Mounting option		Adapter kit CRC <sup>1)</sup>	Part no.	Type
							
	<b>DRRD</b>	<b>HGPD-...-G1/G2</b>			<b>DHAA</b>		
	12	16	■	■	2	2798991	DHAA-G-Q11-12-B12G-16
	12	20	■	■		2800963	DHAA-G-Q11-12-B12G-20
	16	20	■	■		2642948	DHAA-G-Q11-16-B12G-20
	16	25	■	■		2642941	DHAA-G-Q11-16-B12G-25
	20	25	■	■		2642953	DHAA-G-Q11-20-B12G-25
	20	35	■	■		2642961	DHAA-G-Q11-20-B12G-35
	25	35	■	■		2642962	DHAA-G-Q11-25-B12G-35
	25	40	■	■		2642966	DHAA-G-Q11-25-B12G-40
	32	40	■	■		2642967	DHAA-G-Q11-32-B12G-40
	32	50	■	■		2642969	DHAA-G-Q11-32-B12G-50
	35	40	■	■		2643047	DHAA-G-Q11-35-B12G-40
	35, 40	50	■	■		2643100	DHAA-G-Q11-3 5/40-B12G-50
	40	63	■	■		2643055	DHAA-G-Q11-40-B12G-63
	50	63	■	■		2643096	DHAA-G-Q11-50-B12G-63
50	80	■	■		2643098	DHAA-G-Q11-50-B12G-80	
	<b>HSP</b>	<b>HGPD</b>			<b>DHAA, HAPG</b>		
	12	16	■	–	2	564957	DHAA-G-G6-8-B8-16
						540881	HAPG-70-B
	16	16, 20	■	–		564957	DHAA-G-G6-8-B8-16
						540882	HAPG-71-B
25	16, 20	■	–		564957	DHAA-G-G6-8-B8-16	
					540883	HAPG-72-B	
	<b>HSW</b>	<b>HGPD</b>			<b>DHAA, HAPG</b>		
	12, 16	16	■	–	2	564957	DHAA-G-G6-8-B8-16
						540882	HAPG-71-B
	16	20	■	–		564957	DHAA-G-G6-8-B8-16
					540882	HAPG-71-B	

1) More information: [www.festo.com/x/topic/crc](http://www.festo.com/x/topic/crc)

# Adapter for parallel gripper HGPD, sealed



## Accessories

**Adapter kit**  
**DHAA, HAPG**

Material:  
Wrought aluminium alloy  
RoHS-compliant

 **Note**  
The kit includes the individual mounting interface as well as the necessary mounting material.

Permissible drive/gripper combinations with adapter kit Download CAD data → [www.festo.com](http://www.festo.com)

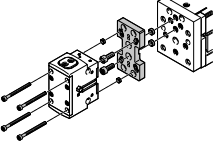
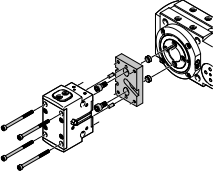
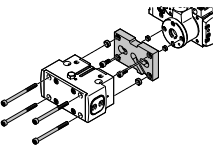
Combination	Drive Size	Gripper Size	Mounting option		Adapter kit CRC <sup>1)</sup>	Part no.	Type
							
<b>EGSL/HGPD</b> 	<b>EGSL</b>	<b>HGPD</b>			<b>DHAA, HAPG</b>		
	45, 55	25	■	■	2	564952	DHAA-G-G6-16-B8-25
	75	25, 35	■	■		537175	HAPG-79
	75	40	■	■		564951	DHAA-G-G6-20-B8-40
<b>ERMB/HGPD</b> 	<b>ERMB</b>	<b>HGPD</b>			<b>DHAA, HAPG</b>		
	20	25	■	■	2	537181	HAPG-SD2-25
	20, 25	35	■	■		537173	HAPG-SD2-23
	25, 32	40	■	■		537184	HAPG-SD2-26
	32	50	■	■		564956	DHAA-G-Q5-32-B8-50
<b>EHMB/HGPD</b> 	<b>EHMB</b>	<b>HGPD</b>			<b>DHAA, HAPG</b>		
	20	40	■	■	2	537184	HAPG-SD2-26
	20, 25, 32	50	■	■		564956	DHAA-G-Q5-32-B8-50
	25, 32	63	■	■		537188	HAPG-SD2-28

1) More information: [www.festo.com/x/topic/crc](http://www.festo.com/x/topic/crc)





## Accessories

**Adapter kit**  
DHAA, HAPG, HMSV, HMVA

Material:  
Wrought aluminium alloy  
RoHS-compliant

 **Note**  
The kit includes the individual mounting interface as well as the necessary mounting material.

Permissible drive/gripper combinations with adapter kit Download CAD data → [www.festo.com](http://www.festo.com)

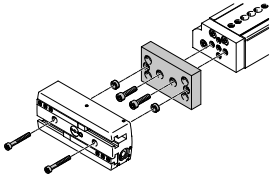
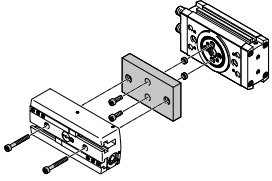
Combination	Drive Size	Gripper Size	Mounting option		Adapter kit		
					CRC <sup>1)</sup>	Part no.	Type
<b>DGSL/HGPL</b>	<b>DGSL</b>	<b>HGPL</b>			<b>DHAA, HAPG</b>		
	16	14-20	■	■	2	2406159	DHAA-G-G6-16-B6-14
	20, 25	14-20	■	■		2410181	DHAA-G-G6-20-B6-14
	16	14-40, 14-60, 14-80	■	■		538055	HAPG-89
	20, 25	14-40, 14-60, 14-80	■	■		539274	HAPG-90
	25	25	■	■		539274	HAPG-90
	16	14-20	■	■	2	2019271	DHAA-G-Q11-16-B6-14-20
	16	14-40	■	■		2019618	DHAA-G-Q11-16-B6-14-40
	16	14-60, 14-80	■	■		2019640	DHAA-G-Q11-16-B6-14-60/80
	20	14-20	■	■		2018509	DHAA-G-Q11-20-B6-14-20
	20	14-40	■	■		2018553	DHAA-G-Q11-20-B6-14-40
	20	14-60, 14-80	■	■		2018986	DHAA-G-Q11-20-B6-14-60/80
	25	14-20	■	■		1813646	DHAA-G-Q11-25-B6-14-20
	25	14-40	■	■		1734087	DHAA-G-Q11-25-B6-14-40
	25	14-60, 14-80	■	■		2018453	DHAA-G-Q11-25-B6-14-60/80
	25	25-20, 25-40	■	■		1794882	DHAA-G-Q11-25-B6-25-20/40
	25	25-60, 25-80	■	■		2020149	DHAA-G-Q11-25-B6-25-60/80
	32	25-20, 25-40	■	■		2021733	DHAA-G-Q11-32-B6-25-20/40
	32	25-60, 25-80	■	■		2022377	DHAA-G-Q11-32-B6-25-60/80
	35	25-20, 25-40	■	■		2022892	DHAA-G-Q11-35-B6-25-20/40
	35	25-60, 25-80	■	■		2023095	DHAA-G-Q11-35-B6-25-60/80
	35, 40	40-20	■	■		2023665	DHAA-G-Q11-35/40-B6-40-20
	35, 40	40-40, 40-60	■	■		2024121	DHAA-G-Q11-35/40-B6-40-40/60
	35, 40	40-80, 40-100	■	■		2024947	DHAA-G-Q11-35/40-B6-40-80/100
	50	40-20	■	■		2387903	DHAA-G-Q11-50-B6-40-20
	50	40-40, 40-60, 40-80, 40-100	■	■		2431288	DHAA-G-Q11-50-B6-40-40/60/80/100
50	63-60, 63-100, 63-150	■	■	2431624	DHAA-G-Q11-50-B6-63-60/100/150		

1) More information: [www.festo.com/x/topic/crc](http://www.festo.com/x/topic/crc)

# Adapter for heavy-duty parallel gripper HGPL-B with long stroke

## Accessories



**Adapter kit**  
DHAA, HAPG

Material:  
Wrought aluminium alloy  
RoHS-compliant

 **Note**  
The kit includes the individual mounting interface as well as the necessary mounting material.

**Permissible drive/gripper combinations with adapter kit**

Download CAD data → [www.festo.com](http://www.festo.com)

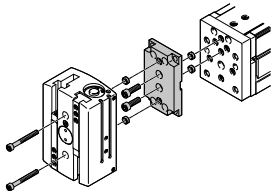
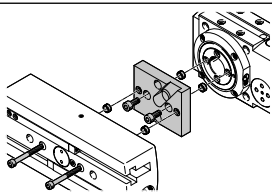
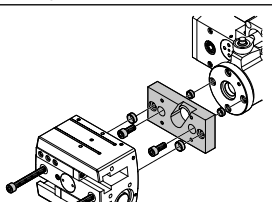
Combination	Drive Size	Gripper Size	Mounting option		Adapter kit		
					CRC <sup>1)</sup>	Part no.	Type
<b>EGSL/HGPL</b>	<b>EGSL</b>	<b>HGPL</b>			<b>DHAA, HAPG</b>		
	45, 55	14-20	■	■	2	2406159	DHAA-G-G6-16-B6-14
	75	14-20	■	■		2410181	DHAA-G-G6-20-B6-14
	45, 55	14-40, 14-60, 14-80	■	■		538055	HAPG-89
	75	14-40, 14-60, 14-80	■	■		539274	HAPG-90
	75	25	■	■		539274	HAPG-90
<b>ERMB/HGPL</b>	<b>ERMB</b>	<b>HGPL</b>			<b>HAPG</b>		
	20	14-40, 14-60, 14-80	■	■	2	537310	HAPG-SD2-31
	25, 32	25	■	■		537311	HAPG-SD2-29
<b>EHMB/HGPL</b>	<b>EHMB</b>	<b>HGPL</b>			<b>DHAA, HAPG</b>		
	25	40-20	■	■	2	2436852	DHAA-G-H2-25-B6-40
	20	25	■	■		537311	HAPG-SD2-29
	25	40-40, 40-60, 40-80, 40-100	■	■		537312	HAPG-SD2-30

1) More information: [www.festo.com/x/topic/crc](http://www.festo.com/x/topic/crc)

## Accessories



Adapter kit  
HAPG

Material:  
Wrought aluminium alloy  
RoHS-compliant

 **Note**

The kit includes the individual mounting interface as well as the necessary mounting material.

Permissible drive/gripper combinations with adapter kit Download CAD data → [www.festo.com](http://www.festo.com)

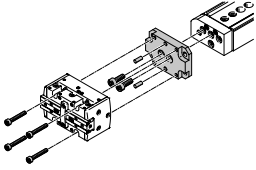
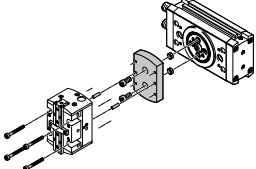
Combination	Drive Size	Gripper Size	Mounting option		Adapter kit		
					CRC <sup>1)</sup>	Part no.	Type
	<b>DGSL</b>	<b>HGPP</b>			<b>HAPG</b>		
	8, 10	10	■	■	2	529017	HAPG-57
	12, 16	10	■	■		529018	HAPG-58
	12, 16	12	■	■		191266	HAPG-48
	20, 25	12	■	■		191267	HAPG-49
	20, 25	16	■	■		191269	HAPG-51
	20, 25	20	■	■		191270	HAPG-52
	<b>DRRD</b>	<b>HGPP</b>			<b>DHAA</b>		
	16	10	■	■	2	2157955	DHAA-G-Q11-16-B5-10
	16	12	■	■		2154048	DHAA-G-Q11-16-B5-12
	20	10	■	■		2158267	DHAA-G-Q11-20-B5-10
	20	12	■	■		2152457	DHAA-G-Q11-20-B5-12
	20	16	■	■		2152074	DHAA-G-Q11-20-B5-16
	25	16	■	■		1722274	DHAA-G-Q11-25-B5-16
	25	20	■	■		1722461	DHAA-G-Q11-25-B5-20
	32	20	■	■		2177999	DHAA-G-Q11-32-B5-20
	32	25	■	■		2180764	DHAA-G-Q11-32-B5-25
	35	25	■	■		2180954	DHAA-G-Q11-35-B5-25
	35, 40	32	■	■		2181855	DHAA-G-Q11-3 5/40-B5-32

1) More information: [www.festo.com/x/topic/crc](http://www.festo.com/x/topic/crc)

Accessories



Adapter kit  
HAPG

Material:  
Wrought aluminium alloy  
RoHS-compliant

 **Note**  
The kit includes the individual mounting interface as well as the necessary mounting material.

Permissible drive/gripper combinations with adapter kit

Download CAD data → [www.festo.com](http://www.festo.com)

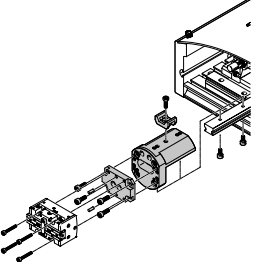
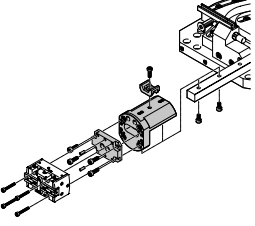
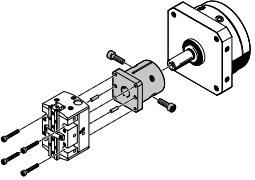
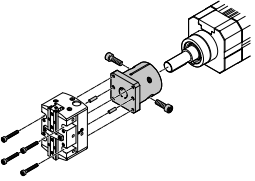
Combination	Drive Size	Gripper Size	Mounting option		Adapter kit		
					CRC <sup>1)</sup>	Part no.	Type
	HSP	HGPP	■	–	2	529017	HAPG-57
						540882	HAPG-71-B
	25	10	■	–	2	529017	HAPG-57
						540883	HAPG-72-B
	16	12	■	–	2	191900	HAPG-54
						540882	HAPG-71-B
	25	12	■	–	2	191900	HAPG-54
						540883	HAPG-72-B
	25	16	■	–	2	191901	HAPG-55
						540883	HAPG-72-B
	HSW	HGPP	■	–	2	529017	HAPG-57
						540882	HAPG-71-B
	16	12	■	–	2	191900	HAPG-54
						540882	HAPG-71-B
	16	16	■	–	2	191901	HAPG-55
						540882	HAPG-71-B
	DSM	HGPP	■	■	2	191258	HAPG-40
						191259	HAPG-41
	25	12	■	■	2	191260	HAPG-42
						191261	HAPG-43
	32	16	■	■	2	191258	HAPG-40
191259						HAPG-41	
40	20	■	■	2	191260	HAPG-42	
					191261	HAPG-43	
	DSL	HGPP	■	■	2	191258	HAPG-40
						191259	HAPG-41
	25	12	■	■	2	191260	HAPG-42
						191261	HAPG-43
	32	16	■	■	2	191258	HAPG-40
191259						HAPG-41	
40	20	■	■	2	191260	HAPG-42	
					191261	HAPG-43	

1) More information: [www.festo.com/x/topic/crc](http://www.festo.com/x/topic/crc)



## Accessories

**Adapter kit**  
**HAPG, HMSV**

Material:  
Wrought aluminium alloy  
RoHS-compliant

 **Note**

The kit includes the individual mounting interface as well as the necessary mounting material.

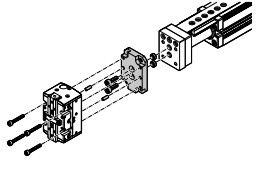
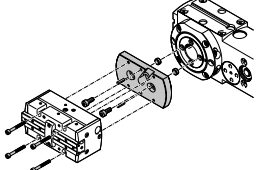
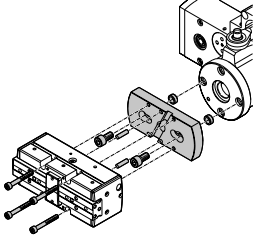
Permissible drive/gripper combinations with adapter kit					Download CAD data → <a href="http://www.festo.com">www.festo.com</a>		
Combination	Drive Size	Gripper Size	Mounting option		Adapter kit CRC <sup>1)</sup>	Part no.	Type
							
<b>EGSL/HGPP</b>	<b>EGSL</b>	<b>HGPP</b>			<b>HAPG, HMSV</b>		
	35	10	■	■	2	1088262	HMSV-70
	45, 55	10	■	■		529017	HAPG-57
	45, 55	12	■	■		529018	HAPG-58
	75	12	■	■		191266	HAPG-48
	75	16	■	■		191267	HAPG-49
						191269	HAPG-51
<b>ERMB/HGPP</b>	<b>ERMB</b>	<b>HGPP</b>			<b>HAPG</b>		
	20	10	■	■	2	526023	HAPG-SD2-17
	20	12	■	■		191255	HAPG-SD2-14
	20, 25	16	■	■		191256	HAPG-SD2-15
	25, 32	20	■	■		191257	HAPG-SD2-16
	32	25	■	■		526024	HAPG-SD2-18
<b>EHMB/HGPP</b>	<b>EHMB</b>	<b>HGPP</b>			<b>HAPG</b>		
	20	20	■	■	2	191257	HAPG-SD2-16
	20, 25, 32	25	■	■		526024	HAPG-SD2-18
	25, 32	32	■	■		526025	HAPG-SD2-19

1) More information: [www.festo.com/x/topic/crc](http://www.festo.com/x/topic/crc)

# Adapter for heavy-duty parallel gripper HGPT-B

## Accessories



Adapter kit  
DHAA, HAPG

Material:  
Wrought aluminium alloy  
RoHS-compliant

 **Note**  
The kit includes the individual mounting interface as well as the necessary mounting material.

### Permissible drive/gripper combinations with adapter kit

Download CAD data → [www.festo.com](http://www.festo.com)

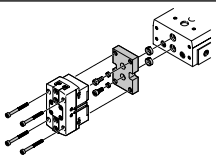
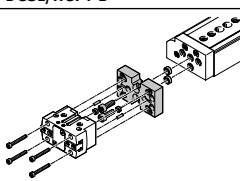
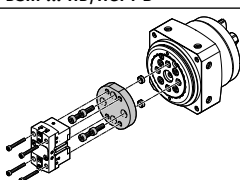
Combination	Drive Size	Gripper Size	Mounting option		Adapter kit					
					CRC <sup>1)</sup>	Part no.	Type			
	<b>DGST</b>	<b>HGPT-B</b>			2	DHAA				
	10	16	–	■			8163575	DHAA-G-G8-10-B8-16		
	12	20	–	■			8163574	DHAA-G-G8-12-B8-20		
	16	25	–	■			8163577	DHAA-G-G8-16-B8-25		
	20	35	–	■			8163576	DHAA-G-G8-20-B8-35		
	25	40	–	■			8163573	DHAA-G-G8-25-B8-40		
	<b>DGST</b>	<b>HGPT-B-...-G1/G2</b>					2	DHAA		
	10	16	–	■					8163580	DHAA-G-G8-10-B8G-16
	12	20	–	■					8163582	DHAA-G-G8-12-B8G-20
	16	25	–	■					8163579	DHAA-G-G8-16-B8G-25
	20	35	–	■	8163581	DHAA-G-G8-20-B8G-35				
	25	40	–	■	8163578	DHAA-G-G8-25-B8G-40				
		<b>DGSL</b>	<b>HGPT-B</b>			2	DHAA, HAPG			
		8, 10	16, 20	■	■			564957	DHAA-G-G6-8-B8-16	
12, 16		16, 20	■	■	564954			DHAA-G-G6-16-B8-16		
12, 16		25	■	■	564952			DHAA-G-G6-16-B8-25		
20, 25		25, 35	■	■	537175			HAPG-79		
20, 25		40	■	■	564951			DHAA-G-G6-20-B8-40		
	<b>DSM-...-HD</b>	<b>HGPT-B</b>			2	DHAA				
	12	16	■	■			8079169	DHAA-G-R3-12-B8-16		
	12	20	■	■			8079170	DHAA-G-R3-12-B8-20		
	16	16	■	■			8079193	DHAA-G-R3-16-B8-16		
	16	20	■	■			8079195	DHAA-G-R3-16-B8-20		
	25	16	■	■			8079202	DHAA-G-R3-25-B8-16		
	25	20	■	■			8079205	DHAA-G-R3-25-B8-20		
	25	25	■	■			8079207	DHAA-G-R3-25-B8-25		
	32	20	■	■			8079217	DHAA-G-R3-32-B8-20		
	32	25	■	■			8079218	DHAA-G-R3-32-B8-25		
	32	35	■	■			8079221	DHAA-G-R3-32-B8-35		

1) More information: [www.festo.com/x/topic/crc](http://www.festo.com/x/topic/crc)



Accessories

Adapter kit  
DHAA

Material:  
Wrought aluminium alloy  
RoHS-compliant

 **Note**  
The kit includes the individual mounting interface as well as the necessary mounting material.

Download CAD data → [www.festo.com](http://www.festo.com)

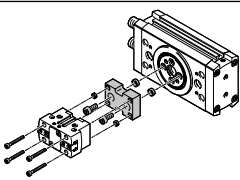
Permissible drive/gripper combinations with adapter kit							
Combination	Drive Size	Gripper Size	Mounting option		Adapter kit		
					CRC <sup>1)</sup>	Part no.	Type
	<b>DRRD</b>	<b>HGPT-B</b>			<b>DHAA</b>		
	12	16	■	■	2	2449927	DHAA-G-Q11-12-B8/B8G-16
	12	20	■	■		2449921	DHAA-G-Q11-12-B8-20
	16	16	■	■		2091740	DHAA-G-Q11-16-B8/B8G-16
	16	20	■	■		2091577	DHAA-G-Q11-16-B8-20
	16	25	■	■		2090543	DHAA-G-Q11-16-B8-25
	20	25	■	■		2088114	DHAA-G-Q11-20-B8-25
	20	35	■	■		2087524	DHAA-G-Q11-20-B8-35
	25	35	■	■		1731604	DHAA-G-Q11-25-B8-35
	25	40	■	■		1731735	DHAA-G-Q11-25-B8-40
	32	40	■	■		2092070	DHAA-G-Q11-32-B8-40
	35	40	■	■		2114241	DHAA-G-Q11-35-B8-40
	32	50	■	■		2118750	DHAA-G-Q11-32-B8-50
	35, 40	50	■	■		2124990	DHAA-G-Q11-3 5/40-B8-50
	40	63	■	■		2125264	DHAA-G-Q11-40-B8-63
	50	63	■	■		2424526	DHAA-G-Q11-50-B8-63
	50	80	■	■		2424527	DHAA-G-Q11-50-B8-80
	<b>DRRD</b>	<b>HGPT-B-G</b>			<b>DHAA</b>		
	12	16	■	■	2	2449927	DHAA-G-Q11-12-B8/B8G-16
	12	20	■	■		2800827	DHAA-G-Q11-12-B8G-20
	16	16	■	■		2091740	DHAA-G-Q11-16-B8/B8G-16
	16	20	■	■		2595935	DHAA-G-Q11-16-B8G-20
	16	25	■	■		2596187	DHAA-G-Q11-16-B8G-25
	20	25	■	■		2596248	DHAA-G-Q11-20-B8G-25
	20	35	■	■		2596517	DHAA-G-Q11-20-B8G-35
	25	35	■	■		2597040	DHAA-G-Q11-25-B8G-35
	25	40	■	■		2597322	DHAA-G-Q11-25-B8G-40
	32	40	■	■		2597387	DHAA-G-Q11-32-B8G-40
	35	40	■	■		2597928	DHAA-G-Q11-35-B8G-40
	32	50	■	■		2597428	DHAA-G-Q11-32-B8G-50
	35, 40	50	■	■		2604977	DHAA-G-Q11-3 5/40-B8G-50
	40	63	■	■		2604813	DHAA-G-Q11-40-B8G-63
	50	63	■	■		2604845	DHAA-G-Q11-50-B8G-63
	50	80	■	■		2604887	DHAA-G-Q11-50-B8G-80

1) More information: [www.festo.com/x/topic/crc](http://www.festo.com/x/topic/crc)

# Adapter for heavy-duty parallel gripper HGPT-B

## Accessories



Adapter kit  
DHAA, HAPG

Material:  
Wrought aluminium alloy  
RoHS-compliant

 **Note**  
The kit includes the individual mounting interface as well as the necessary mounting material.

**Permissible drive/gripper combinations with adapter kit**

Download CAD data → [www.festo.com](http://www.festo.com)

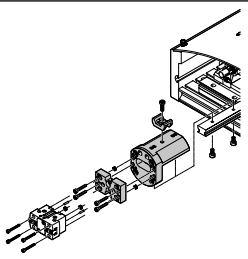
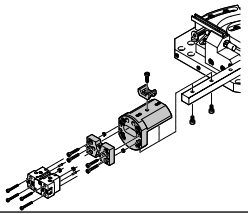
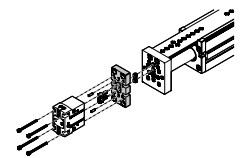
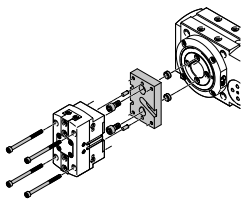
Combination	Drive Size	Gripper Size	Mounting option		Adapter kit		
					CRC <sup>1)</sup>	Part no.	Type
	<b>HSP</b>	<b>HGPT-B</b>			<b>DHAA, HAPG</b>		
	12	16	■	–	2	564957	DHAA-G-G6-8-B8-16
						540881	HAPG-70-B
	16	16, 20	■	–		564957	DHAA-G-G6-8-B8-16
						540882	HAPG-71-B
25	16, 20	■	–	564957		DHAA-G-G6-8-B8-16	
					540883	HAPG-72-B	
	<b>HSW</b>	<b>HGPT-B</b>			<b>DHAA, HAPG</b>		
	12	16	■	–	2	564957	DHAA-G-G6-8-B8-16
						540882	HAPG-71-B
	16	16, 20	■	–		564957	DHAA-G-G6-8-B8-16
				540882		HAPG-71-B	
	<b>EGSL</b>	<b>HGPT-B</b>			<b>DHAA, HAPG</b>		
	45, 55	25	■	■	2	564952	DHAA-G-G6-16-B8-25
	75	40	■	■		564951	DHAA-G-G6-20-B8-40
75	25, 35	■	■	537175		HAPG-79	
	<b>ERMB</b>	<b>HGPT-B</b>			<b>DHAA, HAPG</b>		
	20	25	■	■	2	537181	HAPG-SD2-25
	20, 25	35	■	■		537173	HAPG-SD2-23
	25, 32	40	■	■		537184	HAPG-SD2-26
						564956	DHAA-G-Q5-32-B8-50
32	50	■	■				

1) More information: [www.festo.com/x/topic/crc](http://www.festo.com/x/topic/crc)





## Accessories

Adapter kit  
DHAA, HAPG

Material:  
Wrought aluminium alloy  
RoHS-compliant

 **Note**

The kit includes the individual mounting interface as well as the necessary mounting material.

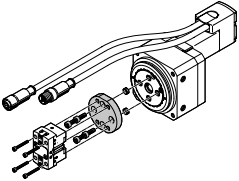
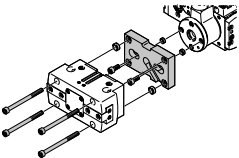
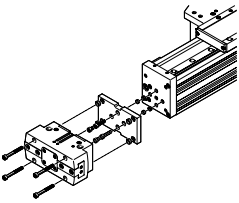
Permissible drive/gripper combinations with adapter kit					Download CAD data → <a href="http://www.festo.com">www.festo.com</a>		
Combination	Drive Size	Gripper Size	Mounting option		Adapter kit CRC <sup>1)</sup>	Part no.	Type
							
	<b>ERMO</b>	<b>HGPT-B</b>			<b>DHAA</b>		
	12	16	■	■	2	8079169	DHAA-G-R3-12-B8-16
	12	20	■	■		8079170	DHAA-G-R3-12-B8-20
	16	16	■	■		8079193	DHAA-G-R3-16-B8-16
	16	20	■	■		8079195	DHAA-G-R3-16-B8-20
	25	16	■	■		8079202	DHAA-G-R3-25-B8-16
	25	20	■	■		8079205	DHAA-G-R3-25-B8-20
	25	25	■	■		8079207	DHAA-G-R3-25-B8-25
	32	20	■	■		8079217	DHAA-G-R3-32-B8-20
	32	25	■	■		8079218	DHAA-G-R3-32-B8-25
	32	35	■	■		8079221	DHAA-G-R3-32-B8-35
	<b>EHMB</b>	<b>HGPT-B</b>				<b>DHAA, HAPG</b>	
	20	40	■	■	2	537184	HAPG-SD2-26
	20, 25, 32	50	■	■		564956	DHAA-G-Q5-32-B8-50
	25, 32	63	■	■		537188	HAPG-SD2-28
	<b>ELCC</b>	<b>HGPT-B</b>			<b>DHAA</b>		
	60	35	■	■	2	5162493	DHAA-G-E21-60-B8-35
	60	40	■	■		5162495	DHAA-G-E21-60-B8-40
	60	50	■	■		5162497	DHAA-G-E21-60-B8-50
	70	40	■	■		2092070	DHAA-G-Q11-32-B8-40
	70, 90	50	■	■		2118750	DHAA-G-Q11-32-B8-50
	70, 90, 110	63	■	■		5162500	DHAA-G-E21-70...110-B8-63
	90, 110	80	■	■		5162502	DHAA-G-E21-70...110-B8-80
	<b>ELCC</b>	<b>HGPT-B-G</b>			<b>DHAA</b>		
	60	35	■	■	2	5162494	DHAA-G-E21-60-B8G-35
	60	40	■	■		5162496	DHAA-G-E21-60-B8G-40
	60	50	■	■		5162498	DHAA-G-E21-60-B8G-50
	70	40	■	■		2597387	DHAA-G-Q11-32-B8G-40
70, 90	50	■	■	2597428		DHAA-G-Q11-32-B8G-50	
70, 90, 110	63	■	■	5162501		DHAA-G-E21-70...110-B8G-63	
90, 110	80	■	■	5162503		DHAA-G-E21-70...110-B8G-80	

1) More information: [www.festo.com/x/topic/crc](http://www.festo.com/x/topic/crc)

# Adapter for three-point gripper DHDS

## Accessories

**Adapter kit**  
DHAA, HAPG, HMSV, HMVA

Material:  
Wrought aluminium alloy  
RoHS-compliant

 **Note**  
The kit includes the individual mounting interface as well as the necessary mounting material.

**Permissible drive/gripper combinations with adapter kit**

Download CAD data → [www.festo.com](http://www.festo.com)

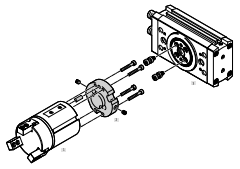
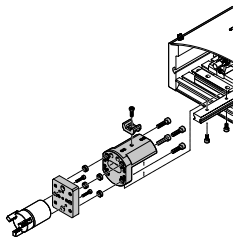
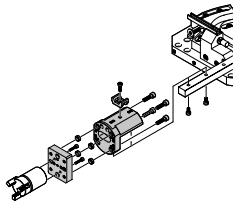
Combination	Drive Size	Gripper Size	Adapter kit		
			CRC <sup>1)</sup>	Part no.	Type
<b>DRRD/DHDS</b>	<b>DRRD</b>	<b>DHDS</b>	<b>DHAA</b>		
	12	16	2	2823512	DHAA-G-Q11-12-B4-16
	16	16		2136626	DHAA-G-Q11-16-B4-16
	16	32		2151381	DHAA-G-Q11-16-B4-32
	20	32		2136339	DHAA-G-Q11-20-B4-32
	25	32		1471583	DHAA-G-Q11-25-B4-32
	25	50		1731165	DHAA-G-Q11-25-B4-50
	32	50		1907040	DHAA-G-Q11-32-B4-50
	35	50		2135899	DHAA-G-Q11-35-B4-50
	<b>HSP/DHDS</b>	<b>HSP</b>		<b>DHDS</b>	<b>HAPG</b>
	16	16	2	192705	HAPG-36-S1
				540882	HAPG-71-B
	25	16		192705	HAPG-36-S1
				540883	HAPG-72-B
<b>HSW/DHDS</b>	<b>HSW</b>	<b>DHDS</b>	<b>HAPG</b>		
	16	16	2	192705	HAPG-36-S1
				540882	HAPG-71-B

1) More information: [www.festo.com/x/topic/crc](http://www.festo.com/x/topic/crc)

2) For DGEA... only

## Accessories

Adapter kit  
DHAA, HAPG

Material:  
Wrought aluminium alloy  
RoHS-compliant

 **Note**

The kit includes the individual mounting interface as well as the necessary mounting material.

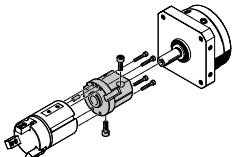
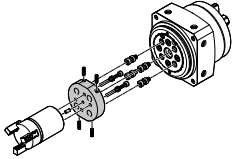
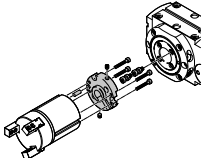
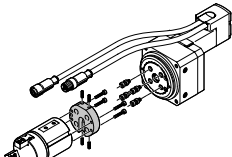
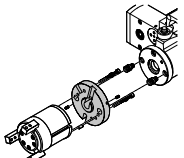
Permissible drive/gripper combinations with adapter kit				Download CAD data → <a href="http://www.festo.com">www.festo.com</a>		
Combination	Drive Size	Gripper Size	Adapter kit			
			CRC <sup>1)</sup>	Part no.	Type	
<b>DSM/DHDS</b>	<b>DSM</b>	<b>DHDS</b>	<b>HAPG</b>			
	8, 10	16	2	187569	HAPG-35	
	25	32		163272	HAPG-23	
<b>DSM-...-HD/DHDS</b>	<b>DSM-...-HD</b>	<b>DHDS</b>	<b>DHAA</b>			
	12	16	2	8072232	DHAA-G-R3-12-B19-16	
	16	16		8079175	DHAA-G-R3-16-B19-16	
	16	32		8079191	DHAA-G-R3-16-B19-32	
	25	32		8079196	DHAA-G-R3-25-B19-32	
	25	50		8079199	DHAA-G-R3-25-B19-50	
	32	50		8079210	DHAA-G-R3-32-B19-50	
<b>ERMB/DHDS</b>	<b>ERMB</b>	<b>DHDS</b>	<b>HAPG</b>			
	20	32	2	184481	HAPG-SD2-5	
	25	50		184484	HAPG-SD2-8	
	32	50		184487	HAPG-SD2-11	
<b>ERMO/DHDS</b>	<b>ERMO</b>	<b>DHDS</b>	<b>DHAA</b>			
	12	16	2	8072232	DHAA-G-R3-12-B19-16	
	16	16		8079175	DHAA-G-R3-16-B19-16	
	16	32		8079191	DHAA-G-R3-16-B19-32	
	25	32		8079196	DHAA-G-R3-25-B19-32	
	25	50		8079199	DHAA-G-R3-25-B19-50	
	32	50		8079210	DHAA-G-R3-32-B19-50	
<b>EHMB/DHDS</b>	<b>EHMB</b>	<b>DHDS</b>	<b>HAPG</b>			
	20	50	2	184487	HAPG-SD2-11	
	25, 32	50		526026	HAPG-SD2-20	

1) More information: [www.festo.com/x/topic/crc](http://www.festo.com/x/topic/crc)

# Adapter for three-point gripper HGDD, sealed

## Accessories

**Adapter kit**  
**DHAA, HAPG**

Material:  
Wrought aluminium alloy  
RoHS-compliant

 **Note**  
The kit includes the individual mounting interface as well as the necessary mounting material.

**Permissible drive/gripper combinations with adapter kit**

Download CAD data → [www.festo.com](http://www.festo.com)

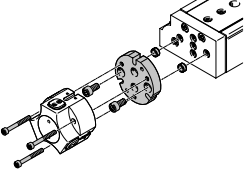
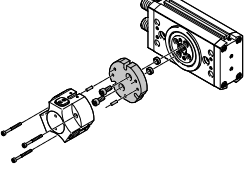
Combination	Drive Size	Gripper Size	Adapter kit		
			CRC <sup>1)</sup>	Part no.	Type
<b>DGSL/HGDD</b>	<b>DGSL</b>	<b>HGDD</b>	<b>DHAA</b>		
	16, 20, 25	35	2	2371422	DHAA-G-G3-20-B13-35
	20, 25	40		2373773	DHAA-G-H2-16-B13-40
	25	50		2377625	DHAA-G-H2-20-B13-50
	<b>DGSL</b>	<b>HGDD-G1/G2</b>	<b>DHAA, HAPG</b>		
	16, 20, 25	35	2	542436	HAPG-94
	20, 25	40		542437	HAPG-95
25	50	2378415		DHAA-G-H2-20-B13G-50	
<b>DRRD/HGDD</b>	<b>DRRD</b>	<b>HGDD</b>	<b>DHAA</b>		
	20	35	2	2075498	DHAA-G-Q11-20-B13-35
	25	35		1718041	DHAA-G-Q11-25-B13-35
	25	40		1718564	DHAA-G-Q11-25-B13-40
	32	40		2077119	DHAA-G-Q11-32-B13-40
	32	50		2078975	DHAA-G-Q11-32-B13-50
	35	50		2079171	DHAA-G-Q11-35-B13-50
	35, 40	63		2079579	DHAA-G-Q11-3 5/40-B13-63
	<b>DRRD</b>	<b>HGDD-G1/G2</b>		<b>DHAA</b>	
	20	35	2	2837144	DHAA-G-Q11-20-B13G-35
	25	35		2837169	DHAA-G-Q11-25-B13G-35
	25	40		2837182	DHAA-G-Q11-25-B13G-40
	32	40		2837254	DHAA-G-Q11-32-B13G-40
	32	50		2837269	DHAA-G-Q11-32-B13G-50
	35	50		2837283	DHAA-G-Q11-35-B13G-50
35, 40	63	2837337		DHAA-G-Q11-3 5/40-B13G-63	

1) More information: [www.festo.com/x/topic/crc](http://www.festo.com/x/topic/crc)

## Accessories

Adapter kit  
DHAA/HAPG

Material:  
Wrought aluminium alloy  
RoHS-compliant

 **Note**

The kit includes the individual mounting interface as well as the necessary mounting material.

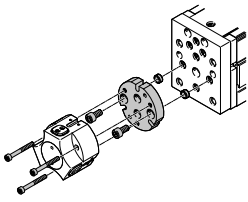
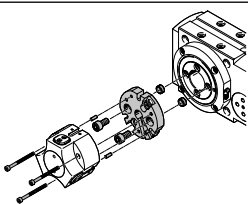
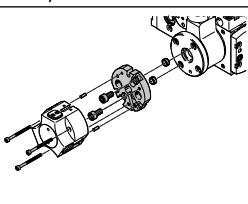
Permissible drive/gripper combinations with adapter kit				Download CAD data → <a href="http://www.festo.com">www.festo.com</a>		
Combination	Drive Size	Gripper Size	Adapter kit			
			CRC <sup>1)</sup>	Part no.	Type	
	<b>EGSL</b>	<b>HGDD</b>	<b>DHAA</b>			
	45, 55, 75	35	2	2371422	DHAA-G-G3-20-B13-35	
	75	40		2373773	DHAA-G-H2-16-B13-40	
	75	50		2377625	DHAA-G-H2-20-B13-50	
	<b>EGSL</b>	<b>HGDD-G1/G2</b>	<b>DHAA, HAPG</b>			
	45, 55, 75	35	2	542436	HAPG-94	
	75	40		542437	HAPG-95	
	75	50		2378415	DHAA-G-H2-20-B13G-50	
		<b>ERMB</b>	<b>HGDD</b>	<b>DHAA</b>		
20, 25, 32		35	2	2376297	DHAA-G-Q5-20-B13-35	
25, 32		40		2376728	DHAA-G-Q5-25-B13-40	
32		50		2377625	DHAA-G-H2-20-B13-50	
<b>ERMB</b>		<b>HGDD-G1/G2</b>	<b>DHAA, HAPG</b>			
20, 25, 32		35	2	542441	HAPG-SD2-34	
25, 32		40		542442	HAPG-SD2-35	
32		50		2378415	DHAA-G-H2-20-B13G-50	
		<b>EHMB</b>	<b>HGDD</b>	<b>DHAA</b>		
	20	35	2	2376297	DHAA-G-Q5-20-B13-35	
	20	40		2376728	DHAA-G-Q5-25-B13-40	
	20	50		2377625	DHAA-G-H2-20-B13-50	
	<b>EHMB</b>	<b>HGDD-G1/G2</b>	<b>DHAA, HAPG</b>			
	20	35	2	542441	HAPG-SD2-34	
	20	40		542442	HAPG-SD2-35	
	20	50		2378415	DHAA-G-H2-20-B13G-50	

1) More information: [www.festo.com/x/topic/crc](http://www.festo.com/x/topic/crc)

# Adapter for heavy-duty three-point gripper HGDT

## Accessories

Adapter kit  
HAPG

Material:  
Wrought aluminium alloy  
RoHS-compliant

 **Note**  
The kit includes the individual mounting interface as well as the necessary mounting material.

**Permissible drive/gripper combinations with adapter kit**

Download CAD data → [www.festo.com](http://www.festo.com)

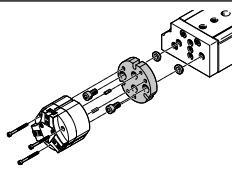
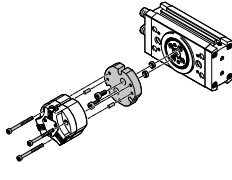
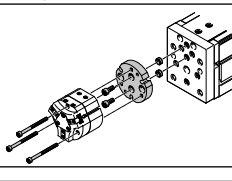
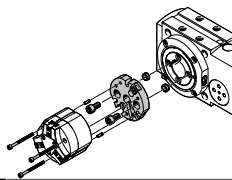
Combination	Drive Size	Gripper Size	Adapter kit CRC <sup>1)</sup>	Part no.	Type	
<b>DGSL/HGDT</b>	<b>DGSL</b>	<b>HGDT</b>	<b>HAPG</b>			
	16	25	2	542439	HAPG-SD2-32	
	16	35		542436	HAPG-94	
	20, 25	35		548805	ZBV-9-7	
	20, 25	40		542436	HAPG-94	
	20, 25	40		542437	HAPG-95	
	25	50		542443	HAPG-SD2-36	
				548806	ZBV-12-9	
<b>DRRD/HGDT</b>	<b>DRRD</b>	<b>HGDT</b>	<b>DHAA</b>			
	16	25	2	2079812	DHAA-G-Q11-16-B7/B7G-25	
	20	25		2079695	DHAA-G-Q11-20-B7/B7G-25	
	20	35		2077056	DHAA-G-Q11-20-B7-35	
	25	35		1735057	DHAA-G-Q11-25-B7-35	
	25	40		1735103	DHAA-G-Q11-25-B7-40	
	32	40		2077253	DHAA-G-Q11-32-B7-40	
	32	50		2077335	DHAA-G-Q11-32-B7-50	
	35	50		2079063	DHAA-G-Q11-35-B7-50	
	35, 40	63		2079274	DHAA-G-Q11-3 5/40-B7-63	
		<b>DRRD</b>	<b>HGDT-G</b>	<b>DHAA</b>		
		20	35	2	2832455	DHAA-G-Q11-20-B7G-35
		25	35		2832483	DHAA-G-Q11-25-B7G-35
		25	40		2832545	DHAA-G-Q11-25-B7G-40
		32	40		2832575	DHAA-G-Q11-32-B7G-40
		32	50		2832600	DHAA-G-Q11-32-B7G-50
		35	50		2832617	DHAA-G-Q11-35-B7G-50
	35, 40	63	2832631		DHAA-G-Q11-3 5/40-B7G-63	
<b>EGSL/HGDT</b>	<b>EGSL</b>	<b>HGDT</b>	<b>HAPG</b>			
	35	25	2	542433	HAPG-97	
	45, 55	25		542439	HAPG-SD2-32	
	45, 55, 75	35		542436	HAPG-94	
	75	40		542437	HAPG-95	
	75	50		542443	HAPG-SD2-36	
<b>ERMB/HGDT</b>	<b>ERMB</b>	<b>HGDT</b>	<b>HAPG</b>			
	20, 25	25	2	542440	HAPG-SD2-33	
	20, 25, 32	35		542441	HAPG-SD2-34	
	25, 32	40		542442	HAPG-SD2-35	
	32	50		542443	HAPG-SD2-36	
<b>EHMB/HGDT</b>	<b>EHMB</b>	<b>HGDT</b>	<b>HAPG</b>			
	20	35	2	542441	HAPG-SD2-34	
	20	40		542442	HAPG-SD2-35	
	20	50		542443	HAPG-SD2-36	

1) More information: [www.festo.com/x/topic/crc](http://www.festo.com/x/topic/crc)



## Accessories

Adapter kit  
HMSV, HAPG, DHAA

Material:  
Wrought aluminium alloy  
RoHS-compliant

 **Note**

The kit includes the individual mounting interface as well as the necessary mounting material.

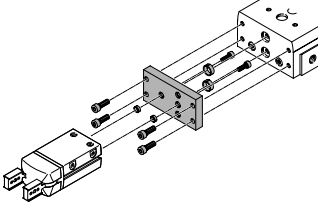
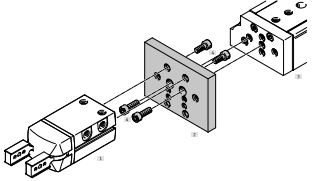
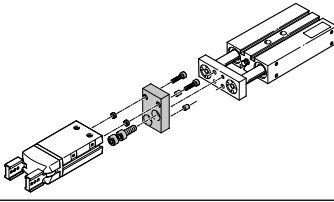
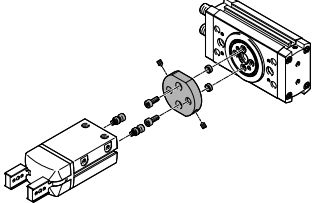
Permissible drive/gripper combinations with adapter kit							Download CAD data → <a href="http://www.festo.com">www.festo.com</a>	
Combination	Drive Size	Gripper		Adapter kit		Type		
		Size	Mounting option	CRC <sup>1)</sup>	Part no.			
								
<b>DGST/DHRS</b>	<b>DGST</b>	<b>DHRS</b>			<b>DHAA</b>			
	10	10	■	■	2	8161907	DHAA-G-G8-10-B20-10	
	12	16	■	■		8161909	DHAA-G-G8-12-B20-16	
	16	16	■	■		8161908	DHAA-G-G8-16-B20-16	
	20	25	■	■		8161905	DHAA-G-G8-20-B20-25	
	25	32	■	■		8161906	DHAA-G-G8-25-B20-32	
<b>DGSL/DHRS</b>	<b>DGSL</b>	<b>DHRS</b>			<b>HMSV</b>			
	8, 10	10	■	■	2	548784	HMSV-54	
	12, 16	16	■	■		548785	HMSV-55	
	20, 25	25, 32	■	■		548786	HMSV-56	
<b>DPZ/DHRS</b>	<b>DPZ</b>	<b>DHRS</b>			<b>HAPG</b>			
	10, 16	16	■	–	2	163250	HAPG-1	
	16	25	■	–		163251	HAPG-2	
	20	25	■	–		163252	HAPG-3	
	25, 32	32	■	–		163253	HAPG-4	
<b>DRRD/DHRS</b>	<b>DRRD</b>	<b>DHRS</b>			<b>DHAA</b>			
	8	10	■	■	2	2816591	DHAA-G-Q11-8-B2/B3-10	
	10	10	■	■		2816068	DHAA-G-Q11-10-B2/B3-10	
	12	10	■	■		2814790	DHAA-G-Q11-12-B2/B3-10	
	12	16	■	■		2811183	DHAA-G-Q11-12-B2/B3-16	
	16	16	■	■		1979085	DHAA-G-Q11-16-B2/B3-16	
	16	25	■	■		1978889	DHAA-G-Q11-16-B2/B3-25	
	20	25	■	■		1978443	DHAA-G-Q11-20-B2/B3-25	
	20	32	■	■		1979912	DHAA-G-Q11-20-B2/B3-32	
	25	25	■	■		1801802	DHAA-G-Q11-25-B2/B3-25	
	25	32	■	■		1802969	DHAA-G-Q11-25-B2/B3-32	
	32	32	■	■		1979992	DHAA-G-Q11-32-B2/B3-32	
	32	40	■	■		1980014	DHAA-G-Q11-32-B2/B3-40	
	35, 40	40	■	■		1980059	DHAA-G-Q11-3 5/40-B2/B3-40	

1) More information: [www.festo.com/x/topic/crc](http://www.festo.com/x/topic/crc)

# Adapter for radial gripper DHRS

## Accessories



Adapter kit  
HAPG, DHAA

Material:  
Wrought aluminium alloy  
RoHS-compliant

 **Note**  
The kit includes the individual mounting interface as well as the necessary mounting material.

### Permissible drive/gripper combinations with adapter kit

Download CAD data → [www.festo.com](http://www.festo.com)

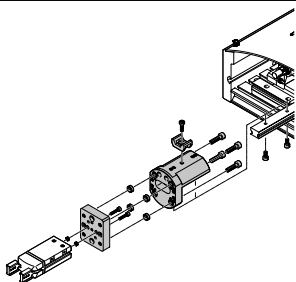
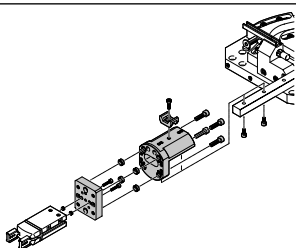
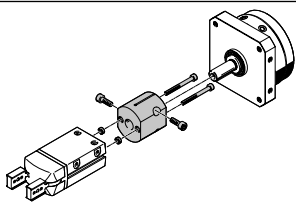
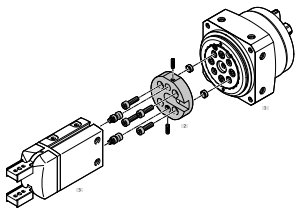
Combination	Drive Size	Gripper		Adapter kit		Type	
		Size	Mounting option		CRC <sup>1)</sup>		Part no.
							
<b>HSP/DHRS</b>	<b>HSP</b>	<b>DHRS</b>			<b>HAPG</b>		
	12	10	■	–	2	192709	HAPG-60-S1
	16	10	■	–		540881	HAPG-70-B
		16	16	■		–	192706
	25	16	■	–		540882	HAPG-71-B
		25	25	■		–	192705
							540882
					192705	HAPG-36-S1	
					540883	HAPG-72-B	
					193922	HAPG-37-S4	
					540883	HAPG-72-B	
<b>HSW/DHRS</b>	<b>HSW</b>	<b>DHRS</b>			<b>HAPG</b>		
	12, 16	10	■	–	2	192706	HAPG-37-S1
		16	■	–		540882	HAPG-71-B
	12, 16	16	■	–		192705	HAPG-36-S1
							540882
<b>DSM/DHRS</b>	<b>DSM-...-FW</b>	<b>DHRS</b>			<b>HAPG</b>		
	6, 8, 10	10	■	■	2	187568	HAPG-34
	<b>DSM-...</b>	<b>DHRS</b>				<b>HAPG</b>	
	12	16	■	■	2	163266	HAPG-17
	16	16	■	■		163267	HAPG-18
	16	25	■	■		163268	HAPG-19
	25	25	■	■		163269	HAPG-20
	25	32	■	■		163270	HAPG-21
	32	32	■	■		163271	HAPG-22
<b>DSM-...-HD/DHRS</b>	<b>DSM-...-HD</b>	<b>DHRS</b>			<b>DHAA</b>		
	12	16	■	■	2	8072157	DHAA-G-R3-12-B18-10
	12	10	■	■		8072172	DHAA-G-R3-12-B20-10
	16	16	■	■		8071917	DHAA-G-R3-16-B18-10
	16	25	■	■		8079173	DHAA-G-R3-16-B18-16
	25	25	■	■		8071956	DHAA-G-R3-25-B18-16
	25	32	■	■		8079201	DHAA-G-R3-25-B20-32
	32	32	■	■		8079208	DHAA-G-R3-32-B18-25
	32	40	■	■		8079212	DHAA-G-R3-32-B20-40

1) More information: [www.festo.com/x/topic/crc](http://www.festo.com/x/topic/crc)





## Accessories

**Adapter kit**  
HAPG, HMSV, DHAA

Material:  
Wrought aluminium alloy  
RoHS-compliant

 **Note**

The kit includes the individual mounting interface as well as the necessary mounting material.

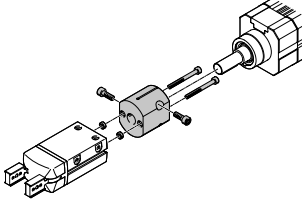
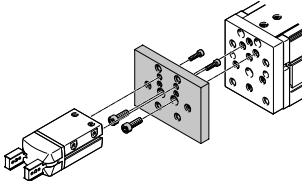
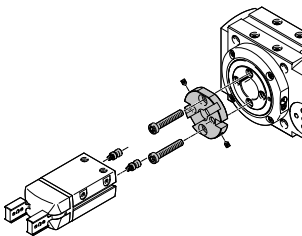
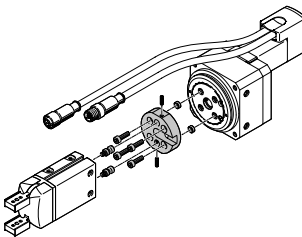
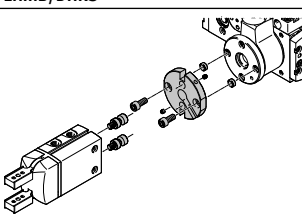
Permissible drive/gripper combinations with adapter kit							Download CAD data → <a href="http://www.festo.com">www.festo.com</a>	
Combination	Drive Size	Gripper		Adapter kit CRC <sup>1)</sup>	Part no.	Type		
		Size	Mounting option					
								
	<b>DSL/DHRS</b>	<b>DSL</b>	<b>DHRS</b>		<b>HAPG</b>			
		16	16	■	■	2	163266	HAPG-17
		20	16	■	■		163267	HAPG-18
		20	25	■	■		163268	HAPG-19
		25	25	■	■		163269	HAPG-20
		25	32	■	■		163270	HAPG-21
		32	32	■	■		163271	HAPG-22
	<b>EGSL/DHRS</b>	<b>EGSL</b>	<b>DHRS</b>		<b>HMSV</b>			
		35	10	■	■	2	548784	HMSV-54
		45, 55	16	■	■		1088262	HMSV-70
		75	25, 32	■	■		548785	HMSV-55
						548786	HMSV-56	
	<b>ERMB/DHRS</b>	<b>ERMB</b>	<b>DHRS</b>		<b>HAPG</b>			
		20	25	■	■	2	184479	HAPG-SD2-3
		25	25	■	■		184482	HAPG-SD2-6
		20	32	■	■		184480	HAPG-SD2-4
		25	32	■	■		184483	HAPG-SD2-7
		32	32	■	■		184485	HAPG-SD2-9
	32	40	■	■		184486	HAPG-SD2-10	
	<b>ERMO/DHRS</b>	<b>ERMO</b>	<b>DHRS</b>		<b>DHAA</b>			
		12	16	■	■	2	8072157	DHAA-G-R3-12-B18-10
		12	10	■	■		8072172	DHAA-G-R3-12-B20-10
		16	16	■	■		8071917	DHAA-G-R3-16-B18-10
		16	25	■	■		8079173	DHAA-G-R3-16-B18-16
		25	25	■	■		8071956	DHAA-G-R3-25-B18-16
		25	32	■	■		8079201	DHAA-G-R3-25-B20-32
		32	32	■	■		8079208	DHAA-G-R3-32-B18-25
	32	40	■	■		8079212	DHAA-G-R3-32-B20-40	
	<b>EHMB/DHRS</b>	<b>EHMB</b>	<b>DHRS</b>		<b>HAPG</b>			
		20	32	■	■	2	184485	HAPG-SD2-9
		20	40	■	■		184486	HAPG-SD2-10
		25, 32	40	■	■		526027	HAPG-SD2-21

1) More information: [www.festo.com/x/topic/crc](http://www.festo.com/x/topic/crc)

## Accessories

Adapter kit  
DHAA

Material:  
Wrought aluminium alloy  
RoHS-compliant





**Note**

The kit includes the individual mounting interface as well as the necessary mounting material.

**Permissible drive/gripper combinations with adapter kit**

Download CAD data → [www.festo.com](http://www.festo.com)

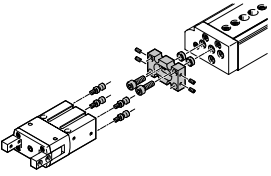
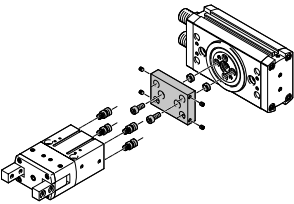
Combination	Drive Size	Gripper Size	Mounting option		Adapter kit CRC <sup>1)</sup>	Part no.	Type
							
<b>DGSL/HGRT</b>	<b>DGSL</b>	<b>HGRT</b>			<b>DHAA</b>		
	8, 10	16	■	■	2	1273902	DHAA-G-G6-8-B11-16
	12, 16	16	■	■		1467524	DHAA-G-G6-12-B11-16
	12, 16	20	■	■		1278364	DHAA-G-G6-12-B11-20
	20, 25	25	■	■		1468307	DHAA-G-G6-20-B11-25
	25	32	■	■		1280494	DHAA-G-G6-25-B11-32
<b>DRRD/HGRT</b>	<b>DRRD</b>	<b>HGRT</b>			<b>DHAA</b>		
	16	16	■	■	2	2185606	DHAA-G-Q11-16-B11-16
	20	20	■	■		2184467	DHAA-G-Q11-20-B11-20
	25	25	■	■		1741183	DHAA-G-Q11-25-B11-25
	25	32	■	■		1743177	DHAA-G-Q11-25-B11-32
	32	25	■	■		2184080	DHAA-G-Q11-32-B11-25
	32	32	■	■		2184322	DHAA-G-Q11-32-B11-32
	32	40	■	■		2184652	DHAA-G-Q11-32-B11-40
	35	40	■	■		2185436	DHAA-G-Q11-35-B11-40

1) More information: [www.festo.com/x/topic/crc](http://www.festo.com/x/topic/crc)



## Accessories

**Adapter kit**  
DHAA, HAPG

Material:  
Wrought aluminium alloy  
RoHS-compliant

 **Note**

The kit includes the individual mounting interface as well as the necessary mounting material.

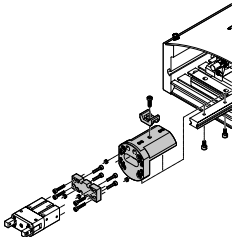
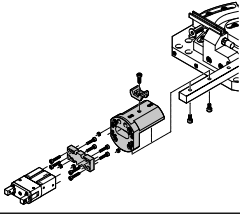
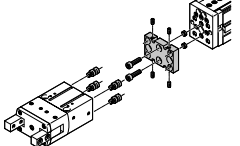
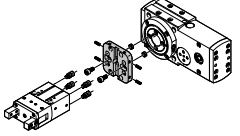
Permissible drive/gripper combinations with adapter kit							Download CAD data → <a href="http://www.festo.com">www.festo.com</a>		
Combination	Drive Size	Gripper Size	Mounting option		Adapter kit CRC <sup>1)</sup>	Part no.	Type		
									
	HSP	HGRT	■	–	DHAA, HAPG	2	1274347	DHAA-G-H4-16-B11-16	
							540882	HAPG-71-B	
	25	16	■	–			1274347	DHAA-G-H4-16-B11-16	
							540883	HAPG-72-B	
	HSW	HGRT	■	–	DHAA, HAPG	2	1274347	DHAA-G-H4-16-B11-16	
							540882	HAPG-71-B	
	12, 16	16							
	EGSL	HGRT	■	■	DHAA	2	1278364	DHAA-G-G6-12-B11-20	
							1279418	DHAA-G-E8-45-B11-25	
		20	25	■			■	1468307	DHAA-G-G6-20-B11-25
		45, 55	25	■			■	1280494	DHAA-G-G6-25-B11-32
		75	32	■			■		
	ERMB	HGRT	■	■	DHAA	2	1465263	DHAA-G-Q5-20-B11-20	
							1279439	DHAA-G-Q5-25-B11-25	
		20	25	■			■	1468949	DHAA-G-Q5-25-B11-32
		25, 32	32	■			■		



1) More information: [www.festo.com/x/topic/crc](http://www.festo.com/x/topic/crc)

Accessories

Adapter kit  
HAPG, HAPS, HMSV

Material:  
Wrought aluminium alloy  
RoHS-compliant

 **Note**  
The kit includes the individual mounting interface as well as the necessary mounting material.

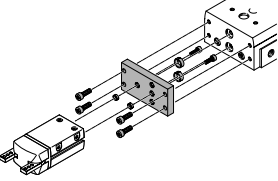
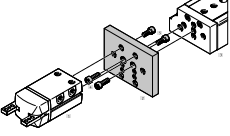
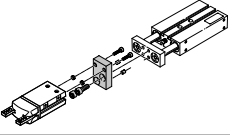
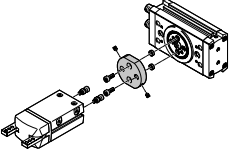
Permissible drive/gripper combinations with adapter kit							Download CAD data → <a href="http://www.festo.com">www.festo.com</a>	
Combination	Drive Size	Gripper Size	Mounting option		Adapter kit CRC <sup>1)</sup>	Part no.	Type	
								
	<b>DGST</b>	<b>DHWS</b>			<b>DHAA</b>			
	10	10	■	■	2	8161907	DHAA-G-G8-10-B20-10	
	12	16	■	■		8161909	DHAA-G-G8-12-B20-16	
	16	16	■	■		8161908	DHAA-G-G8-16-B20-16	
	20	25	■	■		8161905	DHAA-G-G8-20-B20-25	
	25	32	■	■		8161906	DHAA-G-G8-25-B20-32	
	<b>DGSL</b>	<b>DHWS</b>			<b>HMSV</b>			
	8, 10	10	■	■	2	548784	HMSV-54	
	12, 16	16	■	■		548785	HMSV-55	
	20, 25	25, 32	■	■		548786	HMSV-56	
	<b>DPZ</b>	<b>DHWS</b>			<b>HAPG</b>			
	10, 16	16	■	–	2	163250	HAPG-1	
	16	25	■	–		163251	HAPG-2	
	20	25	■	–		163252	HAPG-3	
	25, 32	32	■	–		163253	HAPG-4	
	<b>DRRD</b>	<b>DHWS</b>			<b>DHAA</b>			
	8	10	■	■	2	2816591	DHAA-G-Q11-8-B2/B3-10	
	10	10	■	■		2816068	DHAA-G-Q11-10-B2/B3-10	
	12	10	■	■		2814790	DHAA-G-Q11-12-B2/B3-10	
	12	16	■	■		2811183	DHAA-G-Q11-12-B2/B3-16	
	16	16	■	■		1979085	DHAA-G-Q11-16-B2/B3-16	
	16	25	■	■		1978889	DHAA-G-Q11-16-B2/B3-25	
	20	25	■	■		1978443	DHAA-G-Q11-20-B2/B3-25	
	20	32	■	■		1979912	DHAA-G-Q11-20-B2/B3-32	
	25	25	■	■		1801802	DHAA-G-Q11-25-B2/B3-25	
	25	32	■	■		1802969	DHAA-G-Q11-25-B2/B3-32	
	32	32	■	■		1979992	DHAA-G-Q11-32-B2/B3-32	
	32	40	■	■		1980014	DHAA-G-Q11-32-B2/B3-40	
	35, 40	40	■	■		1980059	DHAA-G-Q11-3 5/40-B2/B3-40	

1) More information: [www.festo.com/x/topic/crc](http://www.festo.com/x/topic/crc)



## Accessories

Adapter kit  
DHAA, HAPG

Material:  
Wrought aluminium alloy  
RoHS-compliant

 **Note**

The kit includes the individual mounting interface as well as the necessary mounting material.

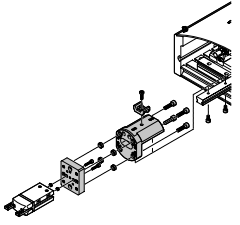
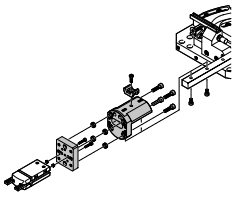
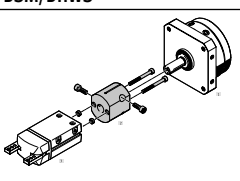
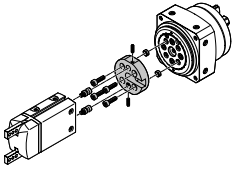
Permissible drive/gripper combinations with adapter kit							Download CAD data → <a href="http://www.festo.com">www.festo.com</a>	
Combination	Drive Size	Gripper Size	Mounting option		Adapter kit CRC <sup>1)</sup>	Part no.	Type	
								
	<b>HSP</b>	<b>DHWS</b>			<b>HAPG</b>			
	12	10	■	–	2	192709	HAPG-60-S1	
						540881	HAPG-70-B	
	16	10	■	–		192706	HAPG-37-S1	
						540882	HAPG-71-B	
	16	16	■	–		192705	HAPG-36-S1	
					540882	HAPG-71-B		
	25	16	■	–		192705	HAPG-36-S1	
						540883	HAPG-72-B	
	25	25	■	–		193922	HAPG-37-S4	
						540883	HAPG-72-B	
	<b>HSW</b>	<b>DHWS</b>			<b>HAPG</b>			
	12, 16	10	■	–	2	192706	HAPG-37-S1	
						540882	HAPG-71-B	
	12, 16	16	■	–		192705	HAPG-36-S1	
						540882	HAPG-71-B	
	<b>DSM-...-FW</b>	<b>DHWS</b>			<b>HAPG</b>			
	6, 8, 10	10	■	■	2	187568	HAPG-34	
	<b>DSM-...</b>	<b>DHWS</b>			<b>HAPG</b>			
	12	16	■	■	2	163266	HAPG-17	
	16	16	■	■		163267	HAPG-18	
	16	25	■	■		163268	HAPG-19	
	25	25	■	■		163269	HAPG-20	
	25	32	■	■		163270	HAPG-21	
32	32	■	■		163271	HAPG-22		
	<b>DSM-...-HD</b>	<b>DHWS</b>			<b>DHAA</b>			
	12	16	■	■	2	8072157	DHAA-G-R3-12-B18-10	
	12	10	■	■		8072172	DHAA-G-R3-12-B20-10	
	16	16	■	■		8071917	DHAA-G-R3-16-B18-10	
	16	25	■	■		8079173	DHAA-G-R3-16-B18-16	
	25	25	■	■		8071956	DHAA-G-R3-25-B18-16	
	25	32	■	■		8079201	DHAA-G-R3-25-B20-32	
	32	32	■	■		8079208	DHAA-G-R3-32-B18-25	
	32	40	■	■		8079212	DHAA-G-R3-32-B20-40	

1) More information: [www.festo.com/x/topic/crc](http://www.festo.com/x/topic/crc)

# Adapter for angle gripper DHWS

## Accessories

Adapter kit  
DHAA, HAPG, HMSV

Material:  
Wrought aluminium alloy  
RoHS-compliant





**Note**

The kit includes the individual mounting interface as well as the necessary mounting material.

**Permissible drive/gripper combinations with adapter kit**

Download CAD data → [www.festo.com](http://www.festo.com)

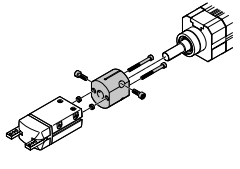
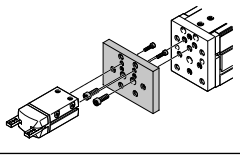
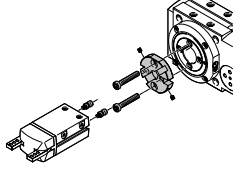
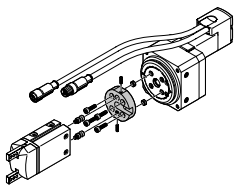
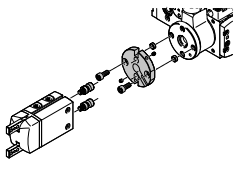
Combination	Drive Size	Gripper Size	Mounting option		Adapter kit CRC <sup>1)</sup>	Part no.	Type
							
	<b>DSL</b>	<b>DHWS</b>			<b>HAPG</b> 2	<b>163266</b>	<b>HAPG-17</b>
	16	16	■	■		<b>163267</b>	<b>HAPG-18</b>
	20	16	■	■		<b>163268</b>	<b>HAPG-19</b>
	20	25	■	■		<b>163269</b>	<b>HAPG-20</b>
	25	25	■	■		<b>163270</b>	<b>HAPG-21</b>
	25	32	■	■		<b>163271</b>	<b>HAPG-22</b>
	<b>EGSL</b>	<b>DHWS</b>			<b>HMSV</b> 2	<b>548784</b>	<b>HMSV-54</b>
	35	10	■	■		<b>1088262</b>	<b>HMSV-70</b>
	45, 55	16	■	■		<b>548785</b>	<b>HMSV-55</b>
	75	25, 32	■	■		<b>548786</b>	<b>HMSV-56</b>
	<b>ERMB</b>	<b>DHWS</b>			<b>HAPG</b> 2	<b>184479</b>	<b>HAPG-SD2-3</b>
	20	25	■	■		<b>184482</b>	<b>HAPG-SD2-6</b>
	25	25	■	■		<b>184480</b>	<b>HAPG-SD2-4</b>
	20	32	■	■		<b>184483</b>	<b>HAPG-SD2-7</b>
	25	32	■	■		<b>184485</b>	<b>HAPG-SD2-9</b>
	32	32	■	■		<b>184486</b>	<b>HAPG-SD2-10</b>
	32	40	■	■			
	<b>ERMO</b>	<b>DHWS</b>			<b>DHAA</b> 2	<b>8072157</b>	<b>DHAA-G-R3-12-B18-10</b>
	12	16	■	■		<b>8072172</b>	<b>DHAA-G-R3-12-B20-10</b>
	12	10	■	■		<b>8071917</b>	<b>DHAA-G-R3-16-B18-10</b>
	16	16	■	■		<b>8079173</b>	<b>DHAA-G-R3-16-B18-16</b>
	16	25	■	■		<b>8071956</b>	<b>DHAA-G-R3-25-B18-16</b>
	25	25	■	■		<b>8079201</b>	<b>DHAA-G-R3-25-B20-32</b>
	25	32	■	■		<b>8079208</b>	<b>DHAA-G-R3-32-B18-25</b>
	32	32	■	■		<b>8079212</b>	<b>DHAA-G-R3-32-B20-40</b>
	32	40	■	■			
	<b>EHMB</b>	<b>DHWS</b>			<b>HAPG</b> 2	<b>184485</b>	<b>HAPG-SD2-9</b>
	20	32	■	■		<b>184486</b>	<b>HAPG-SD2-10</b>
	20	40	■	■		<b>526027</b>	<b>HAPG-SD2-21</b>
	25, 32	40	■	■			

1) More information: [www.festo.com/x/topic/crc](http://www.festo.com/x/topic/crc)



## Accessories

**Adapter kit**  
HMVA, HMSV, HAVB

Material:  
Wrought aluminium alloy  
RoHS-compliant

 **Note**  
The kit includes the individual mounting interface as well as the necessary mounting material.

Permissible drive/gripper combinations with adapter kit Download CAD data → [www.festo.com](http://www.festo.com)

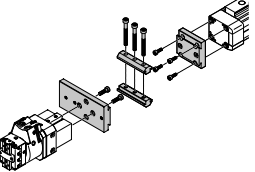
Combination	Drive Size	Gripper Size	Mounting option		Adapter kit		
					CRC <sup>1)</sup>	Part no.	Type
	DGPL	HGDS	■	■	2	177653	HMSV-7
						534290	HMSV-38
	DGPL-25	12, 16, 20	■	■		196788	HMVA-DLA1 8/25
						177653	HMSV-7
	DGPL-40	12, 16, 20	■	■		534290	HMSV-38
						196790	HMVA-DLA40

1) More information: [www.festo.com/x/topic/crc](http://www.festo.com/x/topic/crc)

# Adapter for parallel gripper EHPS

## Accessories



Adapter kit  
DHAA, HAPG, HMSV

Material:  
Wrought aluminium alloy  
Free of copper and PTFE  
RoHS-compliant

 **Note**  
The kit includes the individual mounting interface as well as the necessary mounting material.

### Permissible drive/gripper combinations with adapter kit

Download CAD data → [www.festo.com](http://www.festo.com)

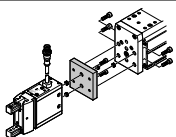
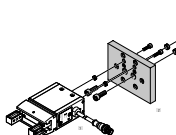
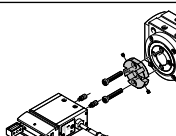
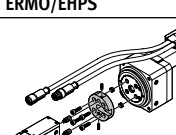
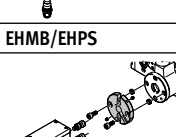
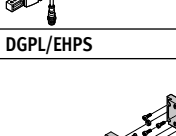
Combination	Drive Size	Gripper Size	Mounting option		Adapter kit			
					CRC <sup>1)</sup>	Part no.	Type	
<b>EGSC/EHPS</b>	<b>EGSC</b>	<b>EHPS</b>			<b>HMSV</b>			
	60	16, 20	■	■	2	<b>8106581</b>	<b>DHAA-G-E8-60-B18-16</b>	
<b>EGSL/EHPS</b>	<b>EGSL</b>	<b>EHPS</b>			<b>HMSV</b>			
	45, 55	16	■	■	2	<b>548785</b>	<b>HMSV-55</b>	
	75	20, 25	■	■		<b>548786</b>	<b>HMSV-56</b>	
<b>ERMB/EHPS</b>	<b>ERMB</b>	<b>EHPS</b>			<b>HAPG</b>			
	20	16, 20	■	■	2	<b>184479</b>	<b>HAPG-SD2-3</b>	
	25	16, 20	■	■		<b>184482</b>	<b>HAPG-SD2-6</b>	
	20	25	■	■		<b>184480</b>	<b>HAPG-SD2-4</b>	
	25	25	■	■		<b>184483</b>	<b>HAPG-SD2-7</b>	
	32	25	■	■		<b>184485</b>	<b>HAPG-SD2-9</b>	
<b>ERMO/EHPS</b>	<b>ERMO</b>	<b>EHPS</b>			<b>DHAA</b>			
	16	16	■	■	2	<b>8079173</b>	<b>DHAA-G-R3-16-B18-16</b>	
	25	16, 20	■	■		<b>8071956</b>	<b>DHAA-G-R3-25-B18-16</b>	
	32	20	■	■		<b>8079214</b>	<b>DHAA-G-R3-32-B18-20</b>	
	32	25	■	■		<b>8079208</b>	<b>DHAA-G-R3-32-B18-25</b>	
<b>EHMB/EHPS</b>	<b>EHMB</b>	<b>EHPS</b>			<b>HAPG</b>			
	20	25	■	■	2	<b>184485</b>	<b>HAPG-SD2-9</b>	
	25, 32	25	■	■		<b>8078739</b>	<b>DHAA-G-H1-25-B18-25</b>	
<b>DGPL/EHPS</b>	<b>DGPL</b>	<b>EHPS</b>			<b>HMVA, HAPG, HMSV</b>			
	<b>Direct mounting</b>				2			
	25, 32	16	■	■		<b>196788</b>	<b>HMVA-DLA18/25</b>	
						<b>193922</b>	<b>HAPG-37-S4</b>	
	40	16	■	■		<b>196790</b>	<b>HMVA-DLA40</b>	
					<b>193922</b>	<b>HAPG-37-S4</b>		
	<b>Dovetail mounting</b>				2			
	25	16	■	■		<b>196788</b>	<b>HMVA-DLA18/25</b>	
						<b>177768</b>	<b>HMSV-28</b>	
	40	16, 20	■	■		<b>196790</b>	<b>HMVA-DLA40</b>	
					<b>177768</b>	<b>HMSV-28</b>		
40	25	■	■	<b>196790</b>	<b>HMVA-DLA40</b>			
				<b>177769</b>	<b>HMSV-29</b>			

1) More information: [www.festo.com/x/topic/crc](http://www.festo.com/x/topic/crc)





## Accessories

Adapter kit  
DHAA, HAPG, HMSV

Material:  
Wrought aluminium alloy  
Free of copper and PTFE  
RoHS-compliant

 **Note**

The kit includes the individual mounting interface as well as the necessary mounting material.

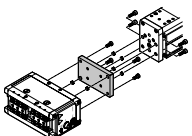
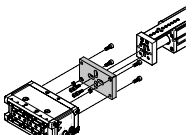
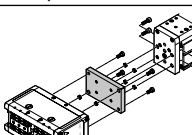
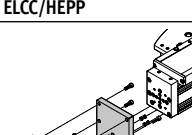
Permissible drive/gripper combinations with adapter kit						Download CAD data → <a href="http://www.festo.com">www.festo.com</a>	
Combination	Drive Size	Gripper Size	Mounting option		Adapter kit CRC <sup>1)</sup>	Part no.	Type
							
	<b>EGSC</b>	<b>HEPP</b>			HMSV 2	8150924	DHAA-G-E19-32-B24-28
	32, 45, 60	28	■	■			
	45, 60	36	■	■			
	<b>EGSL</b>	<b>HEPP</b>			HMSV 2	8150917	DHAA-G-E8-35-B24-28
	35	28	■	■			
	45, 55, 75	28	■	■			
	55, 75	36	■	■			
	<b>ERMB</b>	<b>HEPP</b>			HAPG 2	8154540	DHAA-G-R1-20-B24-28
	20	28	■	■			
	25	28	■	■			
	20	36	■	■			
	25	36, 42	■	■			
	32	42	■	■			
	<b>ELCC</b>	<b>HEPP</b>			DHAA 2	8150928	DHAA-G-E21-60-B24-28
	60	28	■	■			
	70	28	■	■			
	60	36	■	■			
	70	36	■	■			
	90	36	■	■			
	70	42	■	■			
	90, 110	42	■	■			

1) More information: [www.festo.com/x/topic/crc](http://www.festo.com/x/topic/crc)