

## Solenoid valve VSNC-G1/8

**FESTO**

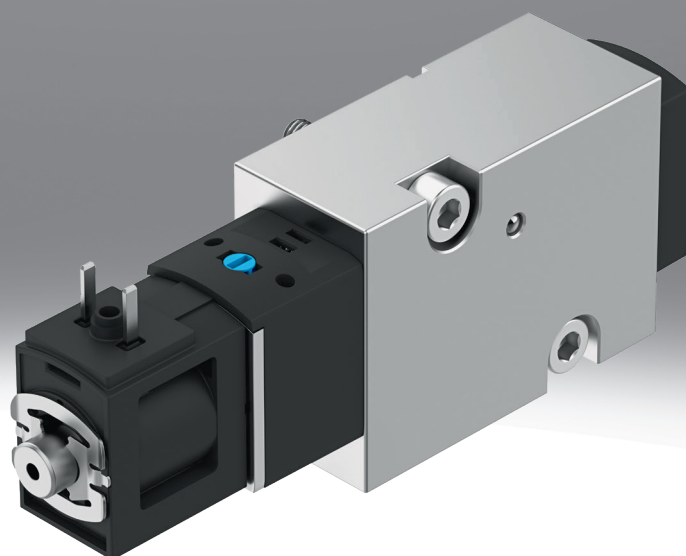

## Characteristics

### At a glance

The Namur valve VSNC is designed for the requirements of the process industry as well as industrial automation. It can be mounted on all G1/8 drives with NAMUR connection pattern to VDI/VDE 3845. This series is an extension of the VSNC product group with the piston spool design, which is smaller and cost-effective.

Function:

VSNC valves are pilot valves for single- and double-acting quarter turn and linear actuators with connection pattern to VDI/VDE 3845, such as DAPS, DFPD, DLP. With the appropriate accessories, such as a connection kit, they can also be mounted on actuators without a NAMUR interface, such as diaphragm actuators. A mechanical spring (single solenoid valves) ensures safe switching in the initial position in the event of a power failure. Working ports 2 and 4 are designed according to VDI/VDE 3845 NAMUR.

### Additional function

[ ] None

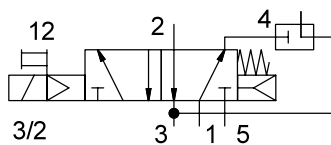
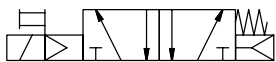

For each valve function (3/2- or 5/2-way valve) of the VSNC-G1/8 two basic positions can be selected in the de-energised state. In the “classic” basic position, the passage from 1 to 4 is pressurised, whereas port 2 is exhausted to 3 (VSNC-...-FK-...). The characteristic “WITHOUT” must be selected for the additional function in this case.

Note: Generally, the function of a 3/2-way valve includes an integrated exhaust return (spring chamber blanketing) and thus protects the spring chamber of the actuator from external influences.

[A] Connections swapped

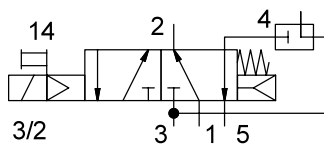
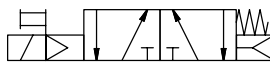

Another possibility is the configuration VSNC-FKA-... where the basic position is pressurised from 1 to 2 and exhausted from 4 to 5 (connections swapped). This gives you the option of always leaving the valve orientation/valve mounting for your quarter turn actuator the same, but changing the quarter turn actuator’s direction of rotation.

## Type code

001	Series	006	Reset method for monostable/single solenoid valves
<b>VSNC</b>	Solenoid valve VSNC	<b>R</b>	Mixed, pneumatic/mechanical spring
002	Directional control valve type	007	Manual override
<b>F</b>	Flanged valve	<b>D</b>	Non-detenting, detenting
003	Design principle	008	Pneumatic connection
<b>K</b>	Piston spool with sealing ring	<b>G18</b>	G1/8
004	Additional function	009	Nominal operating voltage
	None	<b>1</b>	24 V DC
<b>A</b>	Connections swapped	010	Electrical connection
005	Valve function	<b>C1</b>	Plug pattern type C, to EN 175301-803
<b>M52</b>	5/2-way valve, single solenoid/monostable	011	Version
<b>M32C</b>	3/2-way valve, normally closed	<b>S</b>	Focused properties

## Datasheet

## General technical data

Valve function	3/2-way, closed, monostable, 5/2-way, monostable, Connections swapped
Construction width	25.5 mm
Design	Piston slide with sealing ring
Sealing principle	Soft
Type of actuation	Electric
Type of reset	Mechanical spring, Pneumatic spring
Type of piloting	Pilot actuated
Manual override	Detenting
Exhaust-air function	With flow control option
Breather connection	Not ducted
Pilot air supply	Internal
Type of mounting	With through-hole
Mounting position	optional
Standard nominal flow rate	400 l/min
Standard nominal flow rate, exhaust return 4->3	100 l/min
b value	0.3
C value	2.1 l/sbar
Pneumatic connection, port 1	G1/8
Pneumatic connection, port 2	NAMUR port pattern
Pneumatic connection, port 3	G1/8
Pneumatic connection, port 4	NAMUR port pattern
Pneumatic connection, port 5	G1/8
Conforms to standard	VDI/VDE 3845 (NAMUR)
Product weight	220 g

## Operating and ambient conditions

Valve function	3/2-way, closed, monostable, 5/2-way, monostable, Connections swapped
Operating medium	Compressed air to ISO 8573-1:2010 [7:4:4]
Note on operating and pilot medium	Lubricated operation possible (in which case lubricated operation will always be required)
Operating pressure	2.5 ... 8 bar
Ambient temperature	-20 ... 50°C
Media temperature	-20 ... 50°C
Corrosion resistance class CRC <sup>1)</sup>	1 - Low corrosion stress
Degree of protection	IP65

1) More information [www.festo.com/x/topic/kbk](http://www.festo.com/x/topic/kbk)

## Electrical data

Valve function	3/2-way, closed, monostable, 5/2-way, monostable, Connections swapped
Electrical connection	Type C
Characteristic coil data	24 V DC: 2.4 W
Duty cycle	100%
Switching time on	≤50 ms
Switching time off	≤50 ms

## Materials

Short type code	VSNC
Material housing	Wrought aluminium alloy
Material seals	NBR
Material screws	High-alloy stainless steel

## Dimensions

## Dimensions – 3/2 – 5/2-way valve

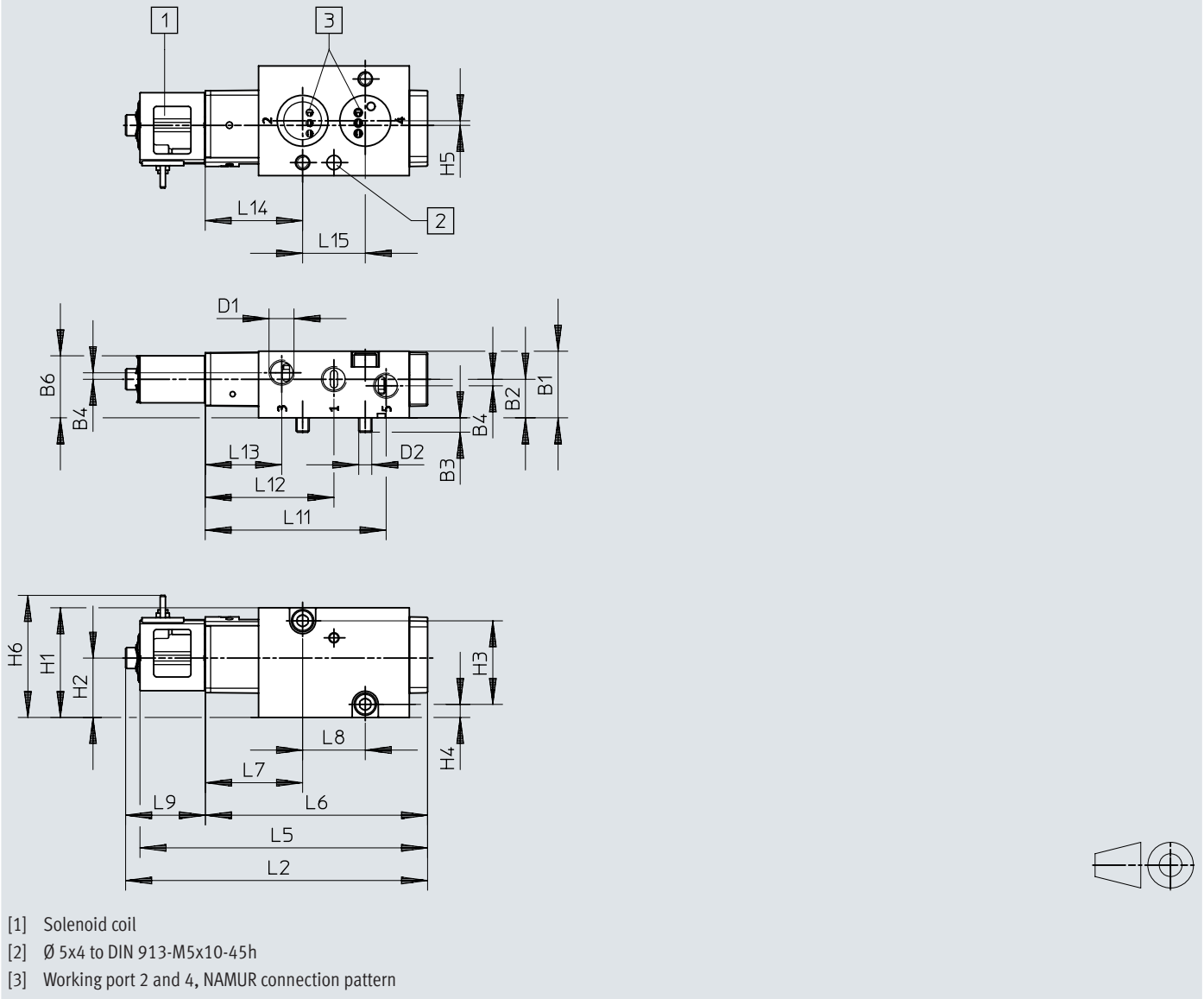
Download CAD data → [www.festo.com](http://www.festo.com)

	B1	B2	B3	B4	B6	D1	D2	H1	H2	H3	H4	H5
VSNC-FK-M52-RD-G18-1C1-S	25,5	14,8	5,5	2,5	23,8	G1/8	M5	42	22,7	32	5	1,7
VSNC-FKA-M52-RD-G18-1C1-S												
VSNC-FK-M32C-RD-G18-1C1-S												
VSNC-FK-M32C-RD-G18-1C1-S												
	H6	L2	L5	L6	L7	L8	L9	L11	L12	L13	L14	L15
VSNC-FK-M52-RD-G18-1C1-S	46,8	115,7	110,2	85,2	37,4	24	30,5	69,4	49,4	29,4	37,4	24
VSNC-FKA-M52-RD-G18-1C1-S												
VSNC-FK-M32C-RD-G18-1C1-S												
VSNC-FK-M32C-RD-G18-1C1-S												

## Dimensions

### Dimensions – Connecting plate

Download CAD data → [www.festo.com](http://www.festo.com)

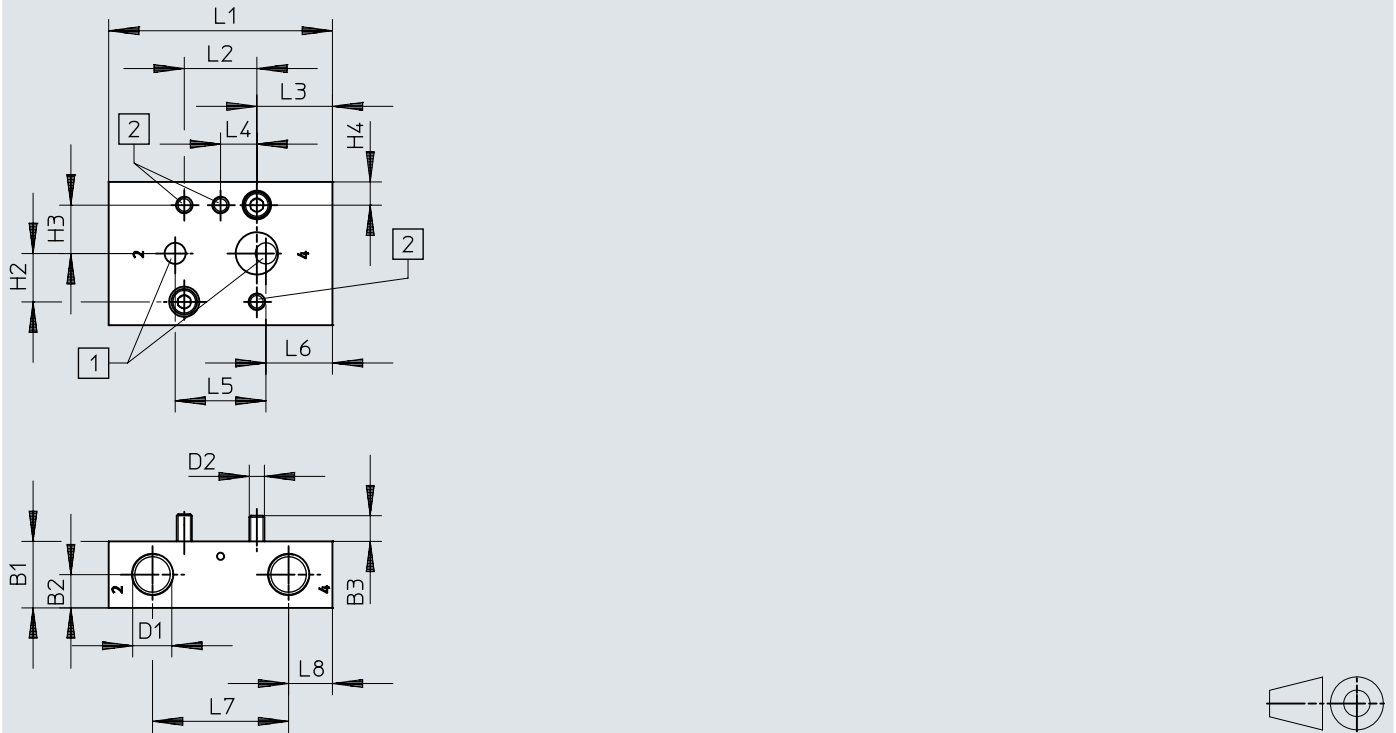

- [1] Working port 2 and 4, NAMUR connection pattern
- [2] Hole for M5 thread

	B1	B2	B3	D1	D2	H1	H2	H3	H4	L1	L2	L3	L4	L5	L6	L7	L8
VABS-B14-T-FG14	22	11	8,5	G1/4	M5	47,4	16	16	7,7	74	24	25	12	30	22	45	14,5
VABS-B14-T-FN14				1/4 NPT													

## Dimensions

## Dimensions – Throttle plate VABF-...P1

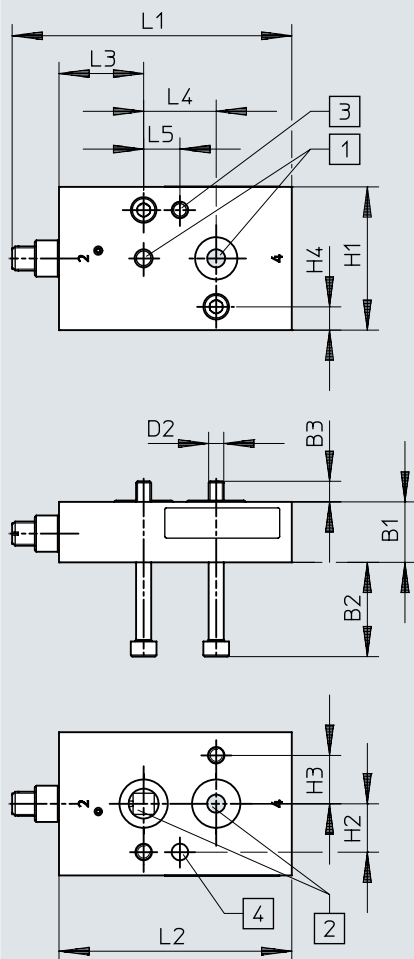
Download CAD data → [www.festo.com](http://www.festo.com)

- [1] Connection pattern 1/4 to "NAMUR"  
 [2] Connection pattern 1/4 to "NAMUR"  
 [3] Hole for M5 thread  
 [4] Drilled hole 5.5 mm  $\varnothing$  for threaded pin to DIN 913-M5x10-45H)



	B1	B2	B3	D2	H1	H2	H3	H4	L1		L2	L3	L4	L5
									min.	max.				
VABF-B14-F1B1P1-FF14	20	31,2	6,8	M5	47,4	16	16	7,7	86,5	92,5	77	28	24	12

## Dimensions

### Dimensions – Throttle plate VABF-...P2

Download CAD data → [www.festo.com](http://www.festo.com)

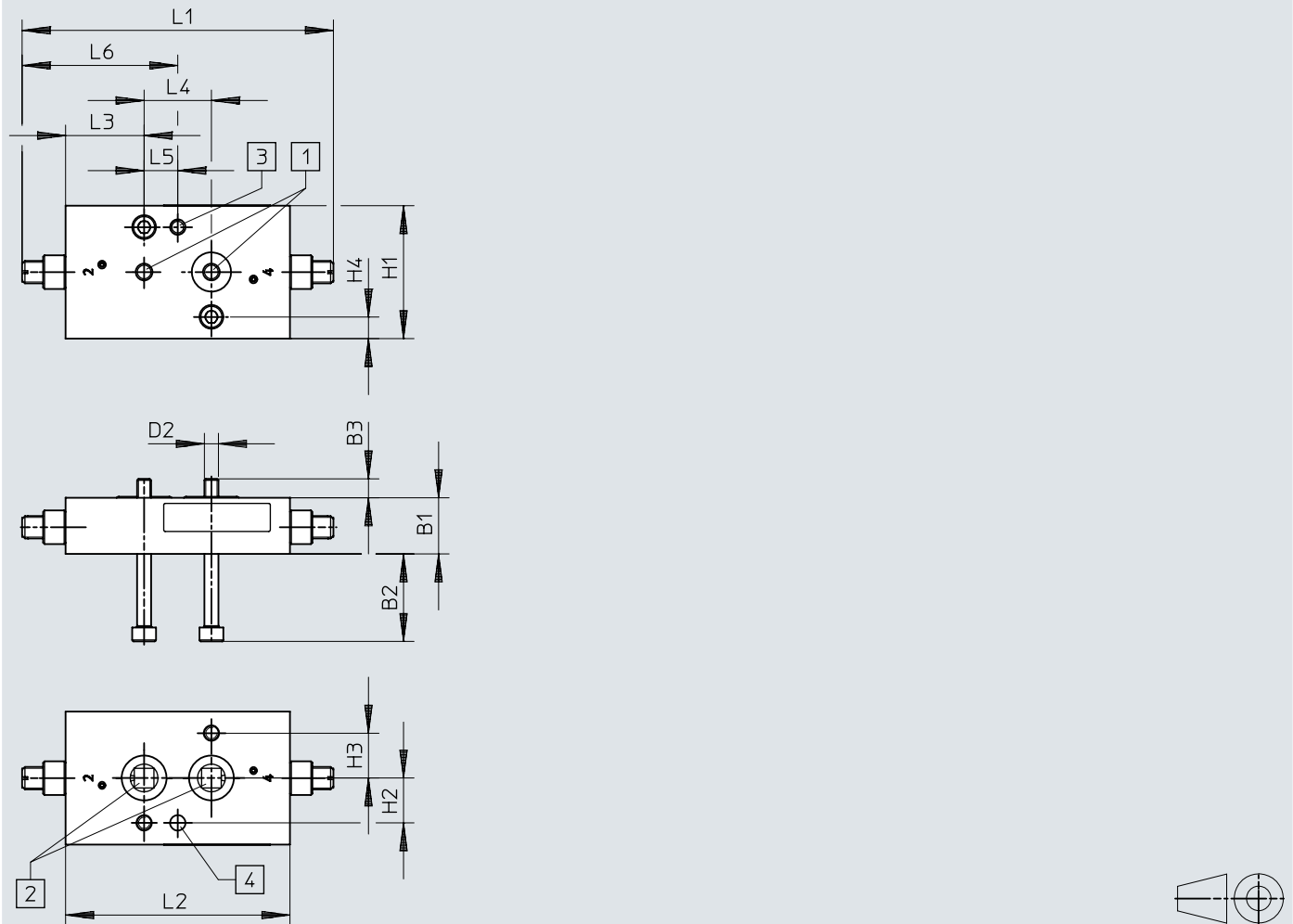

- [1] Connection pattern 1/4 to "NAMUR"
- [2] Connection pattern 1/4 to "NAMUR"
- [3] Hole for M5 thread
- [4] Drilled hole 5.5 mm Ø for threaded pin to DIN 913-M5x10-45H)

	B1	B2	B3	D2	H1	H2	H3	H4	L1		L2	L3	L4	L5	L6	
									min.	max.					min.	max.
VABF-B14-F1B1P2-FF14	20	31,2	6,8	M5	47,4	16	16	7,7	99	110	80	28	24	12	49,5	55,5



## Dimensions

## Dimensions – Exhaust plate

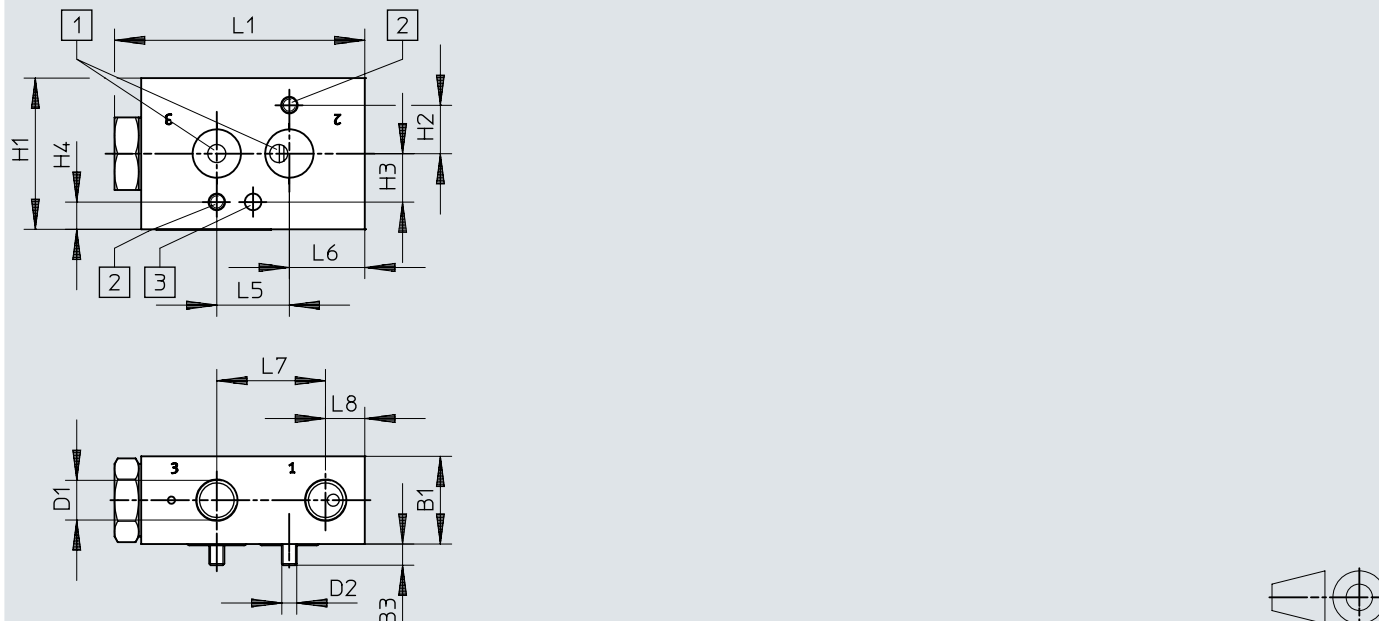
Download CAD data → [www.festo.com](http://www.festo.com)

- [1] Connection pattern 1/4 to "NAMUR"  
 [2] Hole for thread  
 [3] Drilled hole 5.5 mm  $\varnothing$  for threaded pin to DIN 913-M5x10-45H)

	B1	B3	D1	D2	H1	H2	H3	H4	L1	L5	L6	L7	L8
VABF-B14-M3-G14	29	7	G1/4	M5	50	16	16	9	82,8	24	25	36	13
VABF-B14-M3-N14			1/4 NPT										

## Dimensions

### Dimensions – Mounting plate VABS-B14-90-FF14

Download CAD data → [www.festo.com](http://www.festo.com)

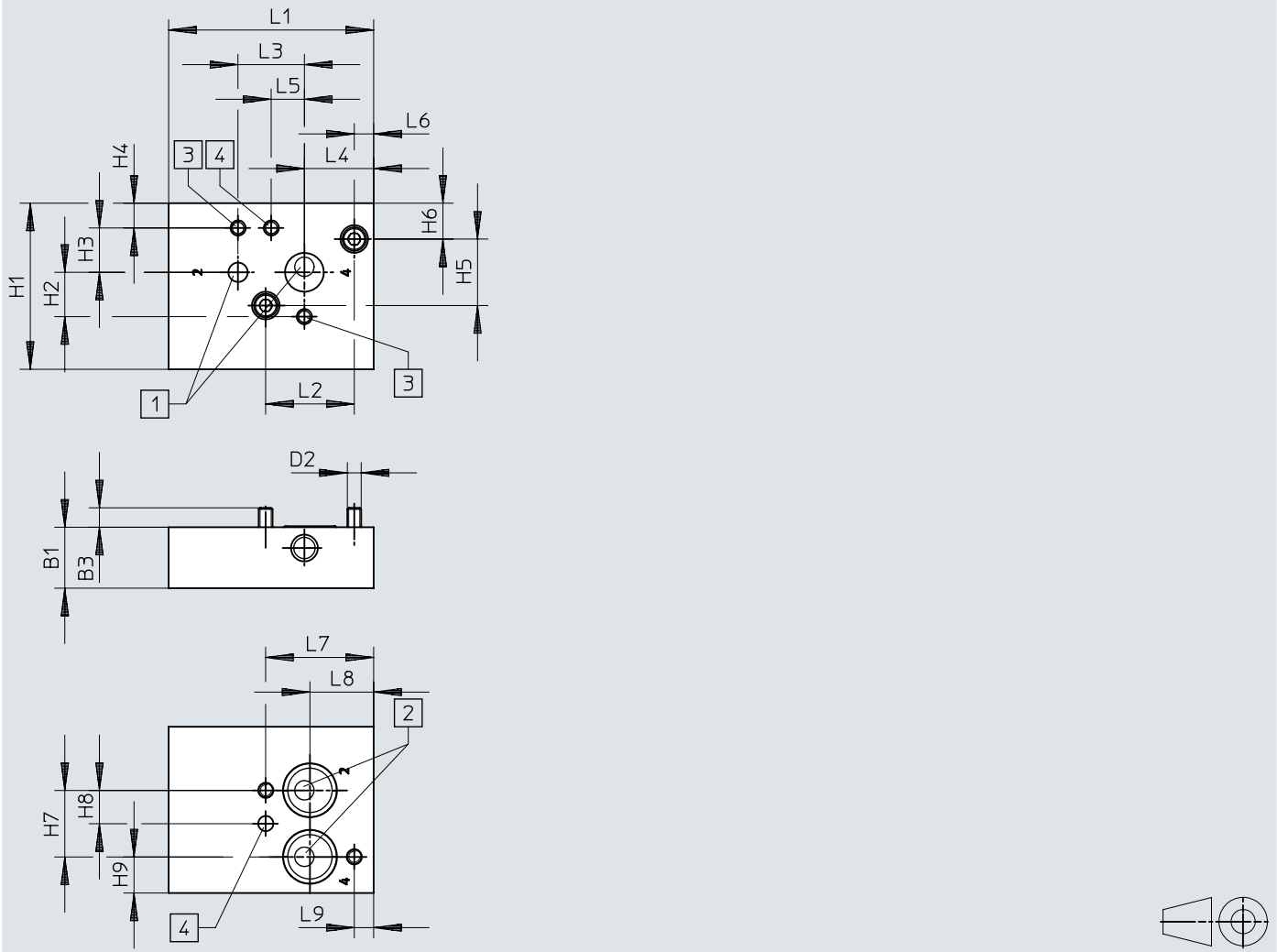

- [1] Connection pattern 1/4 to "NAMUR"
- [2] Connection pattern 1/4 to "NAMUR"
- [3] Hole for M5 thread
- [4] Drilled hole 5.5 mm Ø for threaded pin to DIN 913-M5x10-45H)

	B1	B3	D2	H1	H2	H3	H4	H5	H6	H7	H8
VABS-B14-90-FF14	22	7	M5	60	16	16	9	24	13	24	12

	H9	L1	L2	L3	L4	L5	L6	L7	L8	L9
VABS-B14-90-FF14	13	74	32	24	25	12	7	39	23	7

## Dimensions

## Dimensions – Mounting plate VABS-B14-180-FF14

Download CAD data → [www.festo.com](http://www.festo.com)

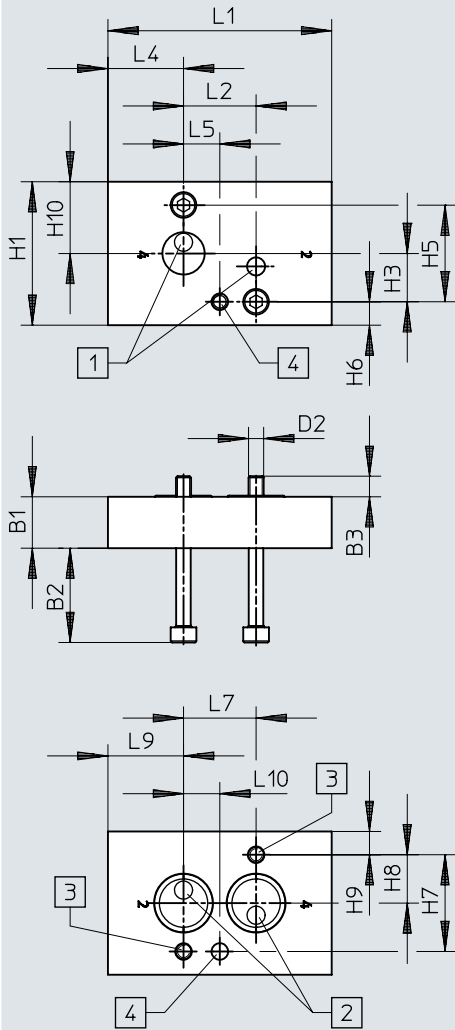
- [1] Connection pattern 1/4 to "NAMUR"
- [2] Connection pattern 1/4 to "NAMUR"
- [3] Hole for M5 thread
- [4] Drilled hole 5.5 mm  $\varnothing$  for threaded pin to DIN 913-M5x10-45H)

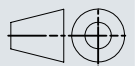

	B1	B2	B3	D2	H1	H3	H5	H6	H7	H8	H9	H10	L1	L2	L4	L5	L7	L9	L10
VABS-B14-180-FF14	17	31,2	6,8	M5	47,4	16	32	7,7	32	16	7,7	23,7	74	24	25	12	24	25	12

## Dimensions

### Dimensions – Mounting plate VABS-B14-270-FF14

Download CAD data → [www.festo.com](http://www.festo.com)

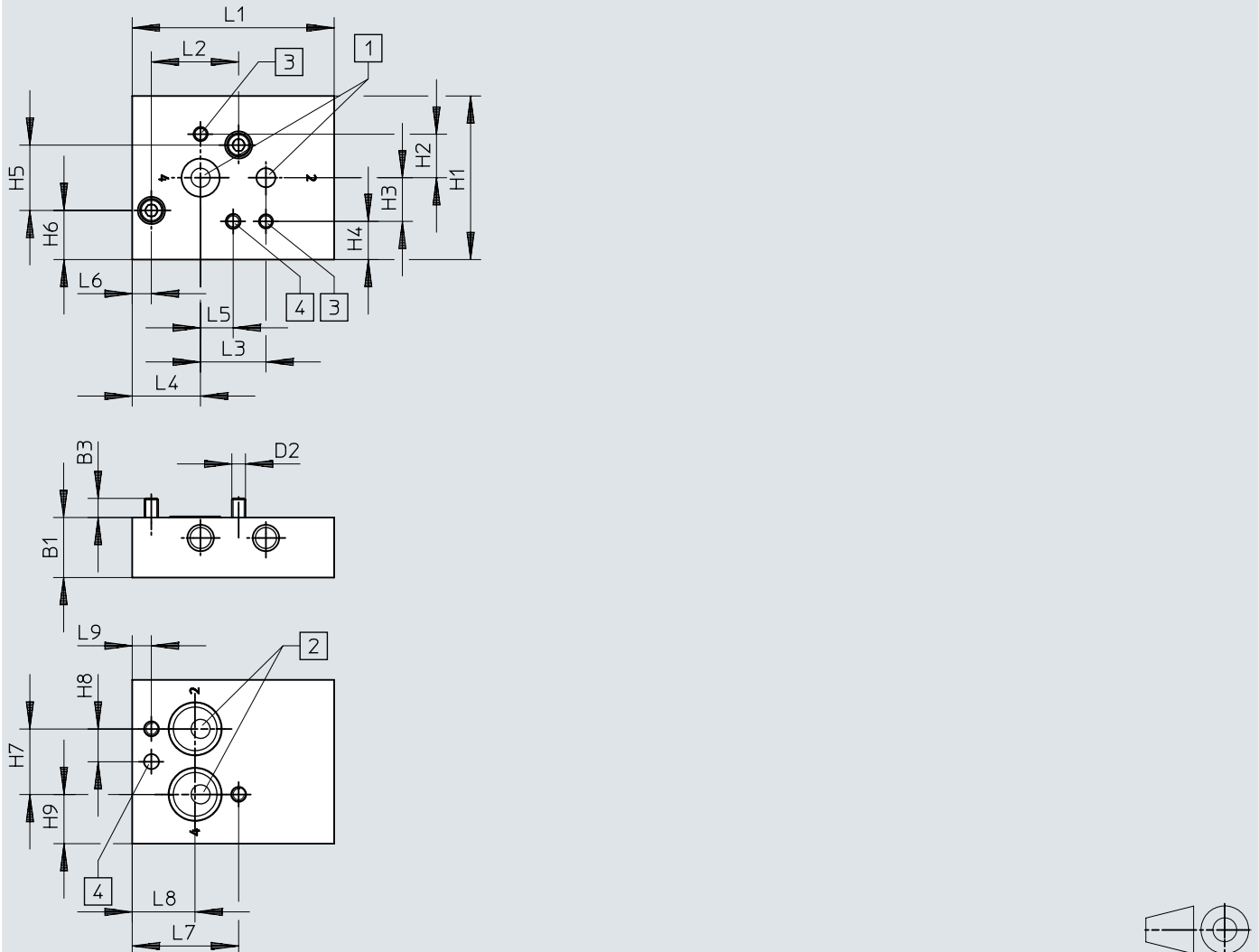

- [1] Connection pattern 1/4 to "NAMUR"
- [2] Connection pattern 1/4 to "NAMUR"
- [3] Hole for M5 thread
- [4] Drilled hole 5.5 mm  $\varnothing$  for threaded pin to DIN 913-M5x10-45H)

	B1	B3	D2	H1	H2	H3	H4	H5	H6	H7	H8
VABS-B14-270-FF14	22	7	M5	60	16	16	14	24	18	24	12

	H9	L1	L2	L3	L4	L5	L6	L7	L8	L9
VABS-B14-270-FF14	18	74	32	24	25	12	7	39	23	7

## Dimensions

## Dimensions – Mounting plate VABA-B14-FL12-FL14

Download CAD data → [www.festo.com](http://www.festo.com)

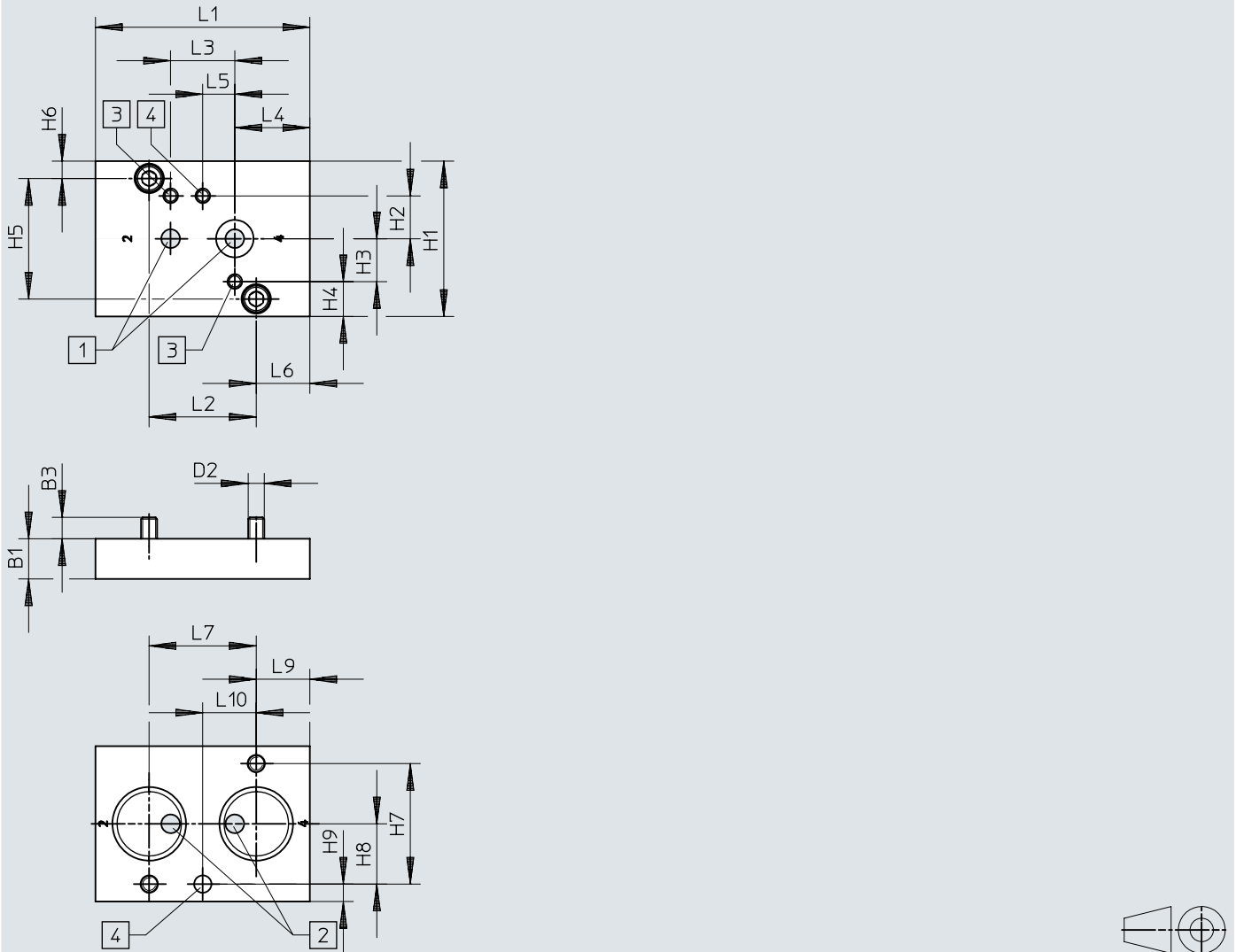
- [1] Connection pattern 1/4 to "NAMUR"
- [2] Connection pattern 1/2 to "NAMUR"
- [3] Hole for M5 thread
- [4] Drilled hole 5.5 mm  $\varnothing$  for threaded pin to DIN 913-M5x10-45H)

	B1	B3	D2	H1	H2	H3	H4	H5	H6	H7	H8
VABA-B14-FL12-FL14	15	8	M6	58	16	16	13	45	6,5	45	22,5

	H9	L1	L2	L3	L4	L5	L6	L7	L9	L10
VABA-B14-FL12-FL14	6,5	80	40	24	28	12	20	40	20	20

## Ordering data

Ordering data				
	Valve function	Construction width	Part no.	Type
	Connections swapped, 3/2-way, closed, monostable	25.5 mm	<b>8166612</b>	<b>VSNC-FKA-M32C-RD-G18-1C1-S</b>
	3/2-way, closed, monostable		<b>8166611</b>	<b>VSNC-FK-M32C-RD-G18-1C1-S</b>
	5/2-way, monostable, Connections swapped		<b>8128473</b>	<b>VSNC-FKA-M52-RD-G18-1C1-S</b>
	5/2-way, monostable		<b>8128472</b>	<b>VSNC-FK-M52-RD-G18-1C1-S</b>

## Peripherals

## Peripherals overview VSNC...-G1/8

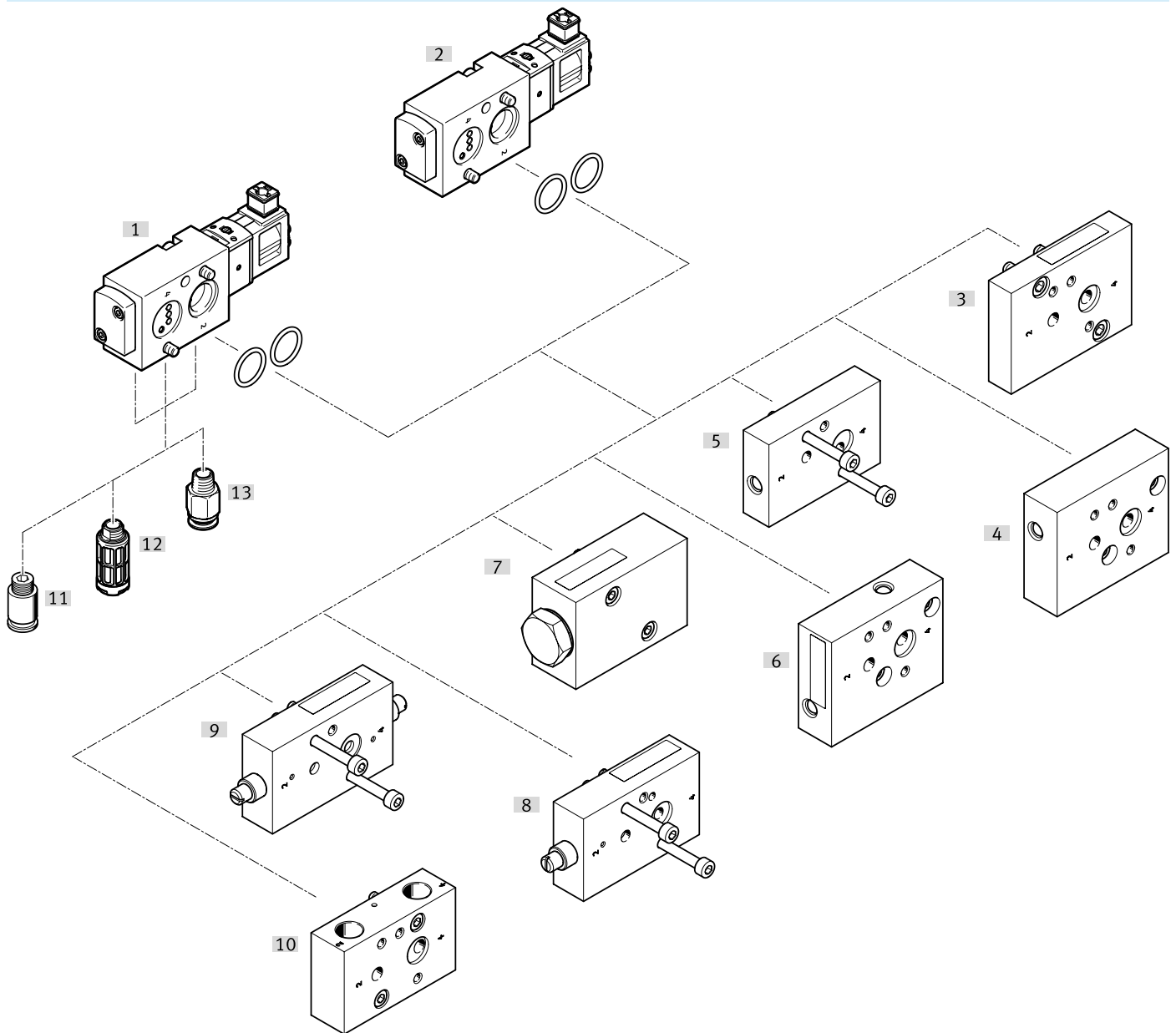

Accessories			→ Page/Internet
Type/order code	Description		
[1] Solenoid valves VSNC...-M32C...	3/2-way single solenoid valve, polymer cover, brass armature tube for actuating single-acting or double-acting drives		vsnc
[2] Solenoid valves VSNC...-M52...	5/2-way single solenoid valve, polymer cover, brass armature tube for controlling double-acting drives		vsnc
[3] Mounting plate VABA-B14-FL12-FL14	Mounting plate with Namur connection 1/2 and 1/4		17
[4] Mounting plate VABS-B14-270-FF14	Namur connection can be turned 270°. It is also possible to mount a 1/4" NAMUR valve on a 1/2" actuator		17
[5] Mounting plate VABS-B14-180-FF14	Namur connection can be turned 180°. It is also possible to mount a 1/4" NAMUR valve on a 1/2" actuator		17
[6] Mounting plate VABS-B14-90-FF14	Namur connection can be rotated 90°. It is also possible to mount a 1/4" NAMUR valve on a 1/2" actuator		17
[7] Exhaust plate VABF-B14-M3-...14	Exhausting a quarter turn actuator with Namur connection via a valve terminal or a normal in-line valve G 1/4 or 1/4 NPT		17
[8] Throttle plate (single-acting) VABF-B14-F1B1P1-FF14	Flow control for single-acting semi-rotary drives		18
[9] Throttle plate (double acting) VABF-B14-F1B1P2-FF14	Flow control for double-acting semi-rotary drives		18
[10] Connector plate VABS-B14-TF ... 14	With the sub-base the Namur valve can be used as an in-line valve with G1/4". And NPT1/4" thread		18

## Peripherals

Accessories		→ Page/Internet
Type/order code	Description	
[11] Push-in fitting QS	For connecting tubing with standard O.D.	18
[12] Silencer	-	19
[13] Cover cap	Exhaust protection IP65. The spring chamber of the actuator is protected against the ingress of aggressive ambient air and water by the one-way flow control system	19



## Accessories

## Mounting plate VABA-B14-FL12-FL14

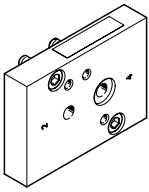
	Type of mounting	Operating pressure	Corrosion resistance class CRC	Part no.	Type
	With through-hole	1.5 ... 10 bar	2 - Moderate corrosion stress	<b>8098889</b>	<b>VABA-B14-FL12-FL14</b>

## Mounting plate VABS-B14-270-FF14

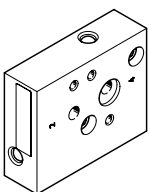
	Type of mounting	Operating pressure	Corrosion resistance class CRC	Part no.	Type
	With through-hole	1.5 ... 10 bar	2 - Moderate corrosion stress	<b>8098891</b>	<b>VABS-B14-270-FF14</b>

## Mounting plate VABS-B14-180-FF14

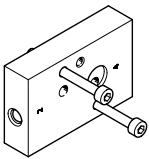
	Type of mounting	Operating pressure	Corrosion resistance class CRC	Part no.	Type
	With through-hole	1.5 ... 10 bar	2 - Moderate corrosion stress	<b>8099347</b>	<b>VABS-B14-180-FF14</b>

## Mounting plate VABS-B14-90-FF14

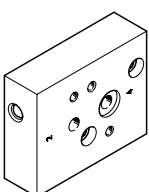
	Type of mounting	Operating pressure	Corrosion resistance class CRC	Part no.	Type
	With through-hole	1.5 ... 10 bar	2 - Moderate corrosion stress	<b>8098888</b>	<b>VABS-B14-90-FF14</b>

## Exhaust plate VABF-B14-M3-...14

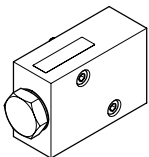
	Type of mounting	Operating pressure	Corrosion resistance class CRC	Part no.	Type
	With through-hole	1.5 ... 10 bar	2 - Moderate corrosion stress	<b>8099627</b>	<b>VABF-B14-M3-N14</b>

## Accessories

## Exhaust plate VABF-B14-M3-...14

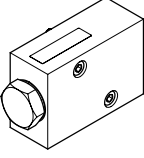
	Type of mounting	Operating pressure	Corrosion resistance class CRC	Part no.	Type
	With through-hole	1.5 ... 10 bar	2 - Moderate corrosion stress	<b>8099350</b>	<b>VABF-B14-M3-G14</b>

## Throttle plate (single-acting) VABF-B14-F1B1P1-FF14

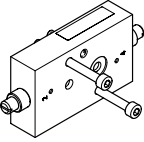
	Type of mounting	Operating pressure	Corrosion resistance class CRC	Part no.	Type
	With through-hole	1.5 ... 10 bar	2 - Moderate corrosion stress	<b>8098885</b>	<b>VABF-B14-F1B1P1-FF14</b>

## Throttle plate (double acting) VABF-B14-F1B1P2-FF14

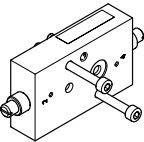
	Type of mounting	Operating pressure	Corrosion resistance class CRC	Part no.	Type
	With through-hole	1.5 ... 10 bar	2 - Moderate corrosion stress	<b>8098887</b>	<b>VABF-B14-F1B1P2-FF14</b>

## Connector plate VABS-B14-T-F ... 14

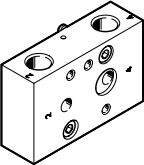
	Type of mounting	Operating pressure	Corrosion resistance class CRC	Part no.	Type
	With through-hole	1.5 ... 10 bar	2 - Moderate corrosion stress	<b>8099628</b>	<b>VABS-B14-T-FN14</b>
				<b>8098884</b>	<b>VABS-B14-T-FG14</b>

## Push-in fitting QS

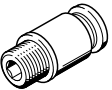
	Pneumatic connection, port 1	Pneumatic connection, port 2	Part no.	Type
	Male thread G1/8	For tubing outside diameter of 4 mm	★ <b>186106</b>	<b>QS-G1/8-4-I</b>
			★ <b>186095</b>	<b>QS-G1/8-4</b>
		For tubing outside diameter of 6 mm	★ <b>186107</b>	<b>QS-G1/8-6-I</b>
			★ <b>186096</b>	<b>QS-G1/8-6</b>
		For tubing outside diameter of 8 mm	★ <b>186109</b>	<b>QS-G1/8-8-I</b>
	★ <b>186098</b>	<b>QS-G1/8-8</b>		
	For tubing outside diameter of 10 mm	★ <b>132999</b>	<b>QS-G1/8-10-I</b>	

## Push-in fitting NPQE

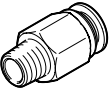
	Pneumatic connection, port 1	Pneumatic connection, port 2	Part no.	Type
	Male thread R1/8	For tubing outside diameter of 4 mm	<b>8112913</b>	<b>NPQE-D-R18-Q4-P10</b>

## Accessories

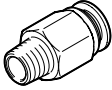
Push-in fitting NPQE				
	Pneumatic connection, port 1	Pneumatic connection, port 2	Part no.	Type
	Male thread R1/8	For tubing outside diameter of 6 mm	8112914	NPQE-D-R18-Q6-P10
		For tubing outside diameter of 8 mm	8112915	NPQE-D-R18-Q8-P10
		For tubing outside diameter of 10 mm	8112916	NPQE-D-R18-Q10-P10
		For tubing outer diameter of 12 mm	8112917	NPQE-D-R18-Q12-P10

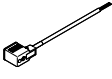
Connecting cable NEBV						
	Cable structure	Nominal operating voltage DC	Cable length	Product weight	Part no.	Type
	2 x 0.75 mm <sup>2</sup>	24 V	2.5 m	120 g	8032623	NEBV-C1SW2L-P-K-2.5-N-LE2-S9
			5 m	230 g	8032626	NEBV-C1SW2L-P-K-5-N-LE2-S9
			10 m	440 g	8032627	NEBV-C1SW2L-P-K-10-N-LE2-S9
	3 x 0.5 mm <sup>2</sup>		2.5 m	125 g	8032628	NEBV-C1SW3-K-2.5-N-LE3-S9
			5 m	235 g	8032629	NEBV-C1SW3-K-5-N-LE3-S9

Silencer			
	Pneumatic connection	Part no.	Type
	G1/8	★ 1206622	AMTE-M-H-G18
		★ 2307	U-1/8
		534222	U-1/8-50
		★ 1205860	AMTE-M-LH-G18
		3670	U-1/8-I
		6841	U-1/8-B
		★ 161419	UC-1/8

Cover cap			
	Material cover cap	Part no.	Type
	POM	8049538	VAMC-B10-20-CH2-S