

## Limit switch boxes SRAP, analogue

**FESTO**

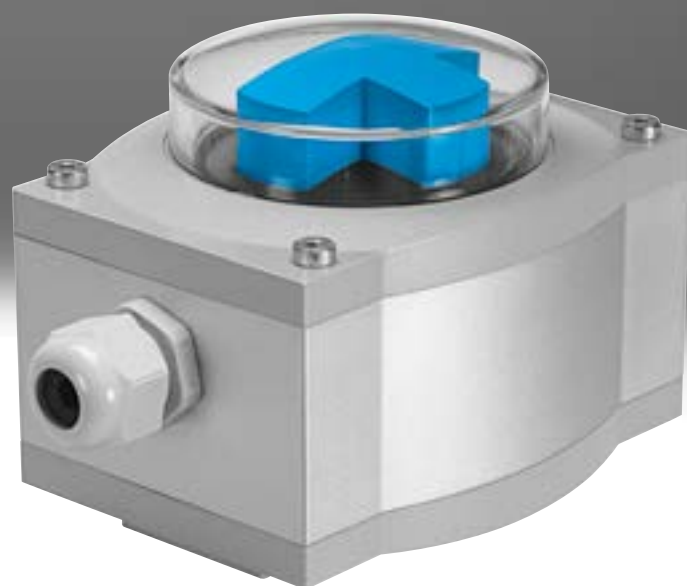

## Key features

### General

Analogue limit switch boxes for increased functionality. The analogue limit switch box is used to monitor the position of quarter-turn actuators and reports the position back to the controller via an analogue 4 ... 20 mA output signal.

### Advantages

- Easy to mount and simple to commission: with teach-in function for the flexible setting of the zero point with a swivel angle range of 0 – 270°
- Clearly visible from a distance: colour-based indication of the current position of the quarter-turn actuator
- Innovative because it's smart: referencing to the actual swivel angle makes optimum use of the output range
- Robust and explosion-proof: with a corrosion-resistant and water-proof metal housing, it can also cope with harsh, corrosive and potentially explosive atmospheres
- Insensitive to vibration. Always supplies a stable signal as there is no contact between the shaft and the sensor
- Quick and easy integration in existing systems due to industry-standard analogue output signal
- Cost and time savings thanks to the common power supply for the limit switch box and solenoid valve
- Cost-efficient control in combination with 5/3-way valve compared with positioner solution
- Festo know-how in automation: concept and solution from a single source
- You can find information on the media resistance of the product at → [www.festo.com](http://www.festo.com)

### 1 cable connector

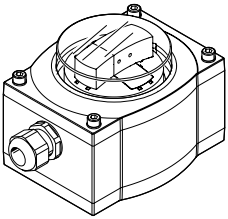

- Power supply for limit switch box only

### 2 cable connectors

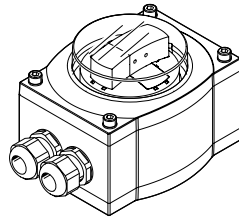

- Common power supply for the limit switch box and solenoid valve

## Peripherals overview

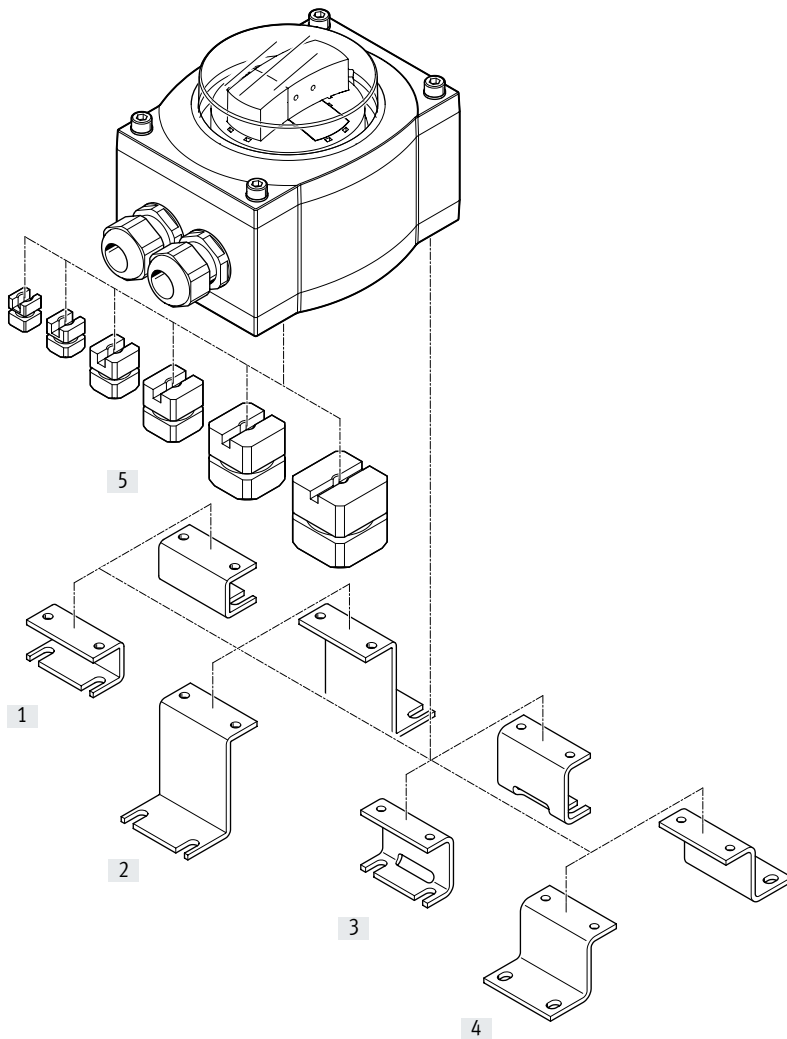

## Mounting attachments and accessories

	Description	→ Page/Internet
[1] Adapter kit DASB-P1-HA-SB	Hole pattern 30x80 mm, height 20 mm	9
[2] Adapter kit DASB-P1-HL-SB	Hole pattern 30x130 mm, height 50 mm	9
[3] Adapter kit DASB-P1-HB-SB	Hole pattern 30x80 mm, height 30 mm	9
[4] Adapter kit DASB-P1-HC-SB	Hole pattern 30x130 mm, height 30 mm	9
[5] Coupling DARQ-CS9	For direct mounting of the limit switch boxes SRAP, spanner size 9	9
Coupling DARQ-CS11	For direct mounting of the limit switch boxes SRAP, spanner size 11	9
Coupling DARQ-CS14	For direct mounting of the limit switch boxes SRAP, spanner size 14	9
Coupling DARQ-CS17	For direct mounting of the limit switch boxes SRAP, spanner size 17	9
Coupling DARQ-CS22	For direct mounting of the limit switch boxes SRAP, spanner size 22	9
Coupling DARQ-CS27	For direct mounting of the limit switch boxes SRAP, spanner size 27	9

## Type codes

001	Series	
<b>SRAP</b>	Sensor box	

002	Product version	
<b>M</b>	Mainly metal	

003	Design type	
<b>C</b>	Sensor box	

004	Mechanical interface	
<b>A1</b>	Direct mounting, hole pattern 30x80 mm	

005	Display type	
	None	
<b>BB</b>	Position indicator blue/black	
<b>GR</b>	Position indicator green/red	
<b>YB</b>	Position indicator, yellow/black	

006	Measuring range	
<b>270</b>	0 ... 270°	

007	Nominal operating voltage	
<b>1</b>	24 V DC	

008	Electrical output 1	
<b>A</b>	4 ... 20 mA	

009	Electrical connection	
<b>T</b>	Terminal box	

010	Cable connector	
<b>M20</b>	M20x1.5, metal	
<b>P20</b>	M20x1.5, polymer	
<b>2P20</b>	2x M20x1.5, polymer	

011	EU certification	
	None	
<b>EX2</b>	II 3GD	

## Data sheet

- The analogue limit switch box not only reports the open/closed position of the quarter-turn actuator, but also detects the entire swivel range and reports this back to the controller via an analogue signal
- The installed sensors are based on tried-and-tested 2D Hall technology



General technical data		
Setting range for angular detection	[deg]	0 ... 270°
Position indicator		
SRAP-M-CA1-BB270-...		Blue/black
SRAP-M-CA1-GR270-...		Red/green
SRAP-M-CA1-YB270-...		Yellow/black
SRAP-M-CA1-270-...		–
Based on standard		VDI/VDE 3845 (NAMUR)
Design		Rectangular
Mounting position		Any
Measured variable		Rotation angle
Measuring principle		Magnetic Hall
Setting options		
Teach-in		
Teach-in via electrical connection		
No-load supply current	[mA]	12 ... 20
Analogue output	[mA]	4 ... 20
Repetition accuracy of analogue output	[deg]	±1°
Operating voltage range DC	[V]	15 ... 30
Insulation voltage	[V]	50
Surge resistance	[kV]	0.8
Short circuit current rating		Yes
Overload protection		Available
Reverse polarity protection		For all electrical connections
Electrical connection		
9-pin		
Screw terminal		
Plug-in		
Cable connector		M20
Max. cable length	[m]	30
Permissible cable diameter	[mm]	5 ... 13
Nominal conductor cross section that can be connected	[mm <sup>2</sup> ]	2.5
Product weight	[g]	1000
Materials		
Housing		Wrought aluminium alloy
Note on materials		RoHS-compliant

## Data sheet

**Operating and environmental conditions without explosion protection**

Certification	RCM
	c UL us - Recognized (OL)
Ambient temperature [°C]	-20 ... +80
Degree of protection	IP65
CE marking (see declaration of conformity) <sup>1)</sup>	To EU EMC Directive <sup>2)</sup>
Protection class	III
Pollution degree	3
Corrosion resistance class CRC <sup>3)</sup>	3

**Operating and environmental conditions with explosion protection**

Certification	RCM
	c UL us - Recognized (OL)
Ambient temperature [°C]	-20 ... +80
Degree of protection	IP65
CE marking (see declaration of conformity) <sup>1)</sup>	To EU EMC Directive <sup>2)</sup>
	To EU Explosion Protection Directive (ATEX)
ATEX category for gas	II 3G
Type of ignition protection for gas	Ex nA IIC T5 X Gc
ATEX category for dust	II 3D
Type of ignition protection for dust	Ex tc IIIC T90°C X Dc IP65
Explosion-proof ambient temperature	-20°C ≤ Ta ≤ +80°C
Explosion protection certification outside the EU	EPL Dc (RU)
	EPL Gc (RU)
Protection class	III
Pollution degree	3
Corrosion resistance class CRC <sup>3)</sup>	3

1) Additional information: [www.festo.com/catalogue/...](http://www.festo.com/catalogue/...) → Support/Downloads.

2) For information about the area of use, see the EC declaration of conformity at: [www.festo.com/catalogue/...](http://www.festo.com/catalogue/...) → Support/Downloads.

If the devices are subject to usage restrictions in residential, commercial or light-industrial environments, further measures for the reduction of the emitted interference may be necessary.

3) Corrosion resistance class CRC 3 to Festo standard FN 940070

High corrosion stress. Outdoor exposure under moderate corrosive conditions. External visible parts with primarily functional surface requirements which are in direct contact with a normal industrial environment.

Data sheet

Dimensions

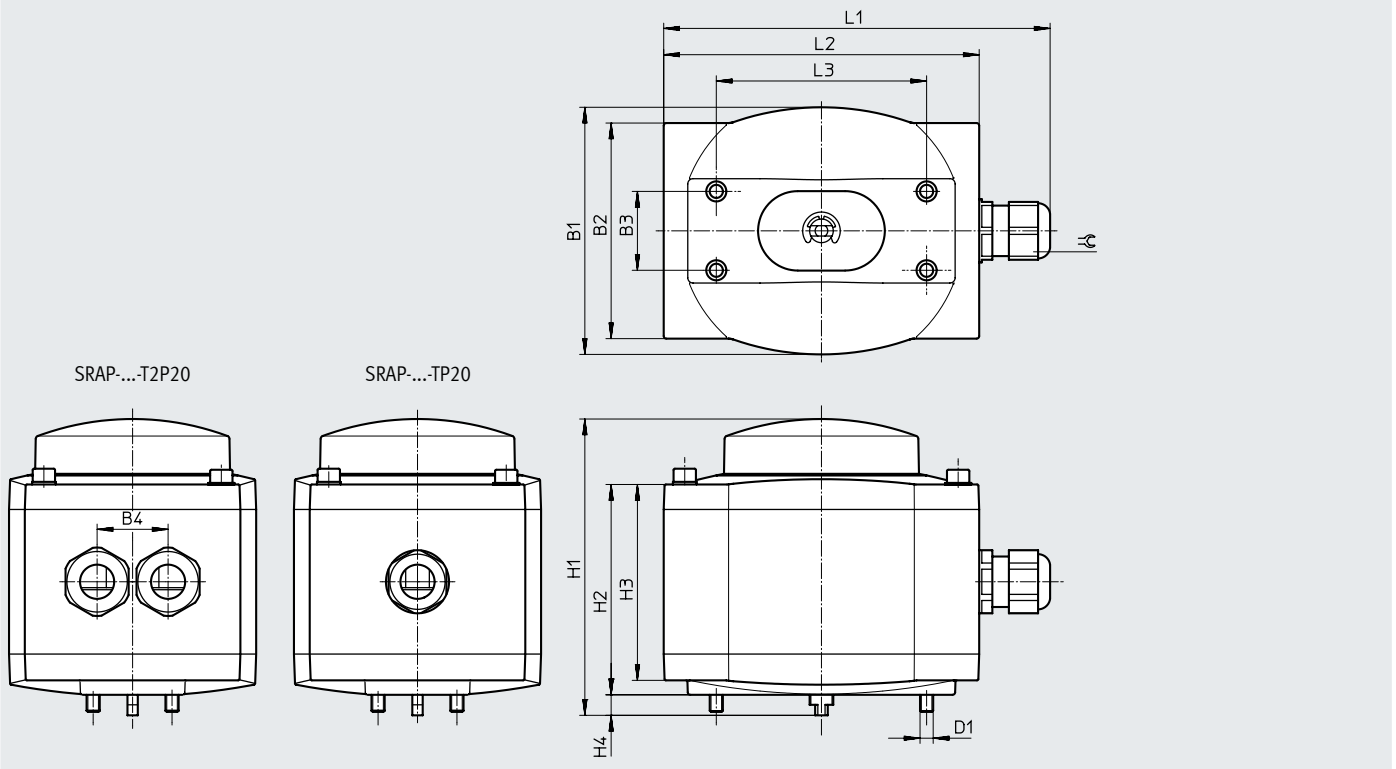

Download CAD data → [www.festo.com](http://www.festo.com)





Type	B1	B2 ±1	B3	B4	D1	H1	H2	H3	H4	L1	L2 ±1	L3	⊕
SRAP-M-CA1-BB270-1-A-TP20	94	82	30	-	M5	112.7	80	74.5	7.8	148	120	80	24
SRAP-M-CA1-BB270-1-A-TP20-EX2													22
SRAP-M-CA1-GR270-1-A-TM20													24
SRAP-M-CA1-GR270-1-A-TP20													22
SRAP-M-CA1-GR270-1-A-TP20-EX2													24
SRAP-M-CA1-YB270-1-A-TM-20													22
SRAP-M-CA1-YB270-1-A-TP-20													24
SRAP-M-CA1-YB270-1-A-TP-20-EX2													
SRAP-M-CA1-GR270-1-A-T2P20													27
SRAP-M-CA1-GR270-1-A-T2P20-EX2													
SRAP-M-CA1-270-1-A-T2P20													
SRAP-M-CA1-270-1-A-T2P20-EX2													

Data sheet

Ordering data – Limit switch boxes SRAP, analogue, without explosion protection



	Position indicator	Part no.	Type
	Blue/black	568236	SRAP-M-CA1-BB270-1-A-TP20
	Red/green	568238	SRAP-M-CA1-GR270-1-A-TM20
	Red/green	568239	SRAP-M-CA1-GR270-1-A-TP20
	Yellow/black	568242	SRAP-M-CA1-YB270-1-A-TM20
	Yellow/black	568243	SRAP-M-CA1-YB270-1-A-TP20
	Red/green	568246	SRAP-M-CA1-GR270-1-A-T2P20
	No indicator	570527	SRAP-M-CA1-270-1-A-T2P20

Ordering data – Limit switch boxes SRAP, analogue, with explosion protection

	Position indicator	Part no.	Type
	Blue/black	568237	SRAP-M-CA1-BB270-1-A-TP20-EX2
	Red/green	568241	SRAP-M-CA1-GR270-1-A-TP20-EX2
	Yellow/black	568245	SRAP-M-CA1-YB270-1-A-TP20-EX2
	Red/green	568247	SRAP-M-CA1-GR270-1-A-T2P20-EX2
	No indicator	570528	SRAP-M-CA1-270-1-A-T2P20-EX2

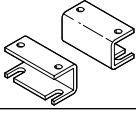
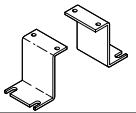
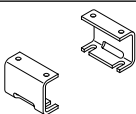
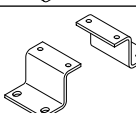
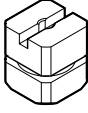

## Accessories

Dimensions and ordering data			
	Description	Part no.	Type
<b>Adapter kits for DAPS</b>			
	• Shaft height 20 mm, hole patterns 80x30 mm	568275	DASB-P1-HA-SB
	• Shaft height 50 mm, hole patterns 130x30 mm	568276	DASB-P1-HL-SB
	• Shaft height 30 mm, hole patterns 80x30 mm	572418	DASB-P1-HB-SB
	• Shaft height 30 mm, hole patterns 130x30 mm	572419	DASB-P1-HC-SB
<b>Couplings for direct mounting of the limit switch boxes SRAP</b>			
	• Spanner size 9, length 10.4 mm	568674	DARQ-C-S9
	• Spanner size 11, length 11.4 mm	568675	DARQ-C-S11
	• Spanner size 14, length 15.6 mm	568676	DARQ-C-S14
	• Spanner size 17, length 18.4 mm	568677	DARQ-C-S17
	• Spanner size 22, length 23.9 mm	568678	DARQ-C-S22
	• Spanner size 27, length 28.9 mm	568679	DARQ-C-S27
<b>Cable connectors</b>			
	• Polymer cable connector M20x1.5	568278	NETC-P-M20-KA
	• Metal cable connector M20x1.5	568279	NETC-M-M20-KA