

## Plastic tubing PUN-H, PUN-H-DUO

**FESTO**



## Characteristics

### At a glance

Flexible and hydrolysis-resistant tubing with standard O.D. in various colours in single or double tubing design

- Polyurethane
- Highly resistant to microbes and hydrolysis
- Food grade see [www.festo.com/certificates/PUN\\_H](http://www.festo.com/certificates/PUN_H)
- Suitable for energy chains
- Also available as DUO plastic tubing
- Operating medium: compressed air, vacuum, water
- Very easy installation thanks to “one-click” principle

Recommended tubing/fitting combinations (further information at [www.festo.com/catalogue/pun-h](http://www.festo.com/catalogue/pun-h) → Support/Downloads):

- PUN-H/PUN-H-DUO with QS fitting (for tube size 2 to 12; 16 and 22)
- PUN-H/PUN-H-DUO with NPQH fitting (for tube size 4 to 14)
- PUN-H with NPKA fitting (for tube size 6) → cleanroom-compatible combination

### Product segmentation



Festo Core Range

Solves the majority of your automation tasks

With the Festo Core Range, we have selected the most important products and functions from our broad product catalogue, and added the quickest delivery. The Core Range offers you the best value with the expected high Festo quality.

- Quickest delivery, worldwide – wherever, whenever
- Expected high Festo quality
- Easy and fast to select

### Ordering data - modular system

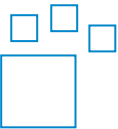

Configurable product

This product and all its product options can be ordered online via the configurator.

### Diagrams

[Further information → pun-h](#)



The diagrams shown in this document are also available online. These can be used to display precise values.

### Alternative material characteristic

[H] Hydrolysis-resistant

Hydrolysis-resistant and suitable for water applications.

### Pipe/tubing O.D. x wall thickness

For standard O.D. tubing, the outside diameter of the tube and the wall thickness are given as the tube size.

### Tubing type

[ ] Standard

Consists of a single tube

[DUO] DUO pneumatic tubing

Two pieces of tubing are welded together to form a pair. During installation, the tubing pair is cut to the required length at both ends.

## Characteristics

### Packaging unit [m]

- Standard: 50 m
- In some cases, available in longer lengths on a reel.

Type code

001		Series
PUN		Plastic tubing, polyurethane
002		Alternative material characteristic
H		Hydrolysis-resistant
003		Pipe/tubing O.D. x wall thickness
2x0,4		2x0.4 mm
3x0,5		3x0.5 mm
4x0,75		4x0.75 mm
6x1		6x1 mm
8x1,25		8x1.25 mm
10x1,5		10x1.5 mm
12x2		12x2 mm
14x2		14x2 mm
16x2,5		16x2.5 mm
004		Tubing type
		Standard
DUO		DUO pneumatic tubing

005		Colour
BL		Blue
BS		Blue/black
GE		Yellow
GN		Green
NT		Natural
RT		Red
SI		Silver
SW		Black
TBL		Translucent blue
TGE		Translucent yellow
TGN		Translucent green
TRT		Translucent red
TSW		Translucent black
006		Packaging unit [m]
		Standard
25		25 m
100		100 m
200		200 m
300		300 m
400		400 m
500		500 m

## Datasheet

## Operating and environmental conditions PUN-H with O.D. 2 mm

Outside diameter	2 mm
Inside diameter	1.2 mm
Pneumatic connection	For push-in connector O.D. 2 mm
Flow-relevant bending radius	8 mm
Min. bending radius	5 mm
Temperature-dependent operating pressure	-0.095 ... 1 MPa
Temperature-dependent operating pressure	-0.95 ... 10 bar
Temperature-dependent operating pressure	-13.775 ... 145 psi
Operating pressure complete temperature range	-0.095 ... 0.6 MPa
Operating pressure complete temperature range	-0.95 ... 6 bar
Operating pressure complete temperature range	-13.775 ... 87 psi
Operating medium	Compressed air to ISO 8573-1:2010 [7:-]
Ambient temperature	-35 ... 60°C
Tubing characteristics	Suitable for energy chains

## Operating and environmental conditions PUN-H with O.D. 3 ... 16 mm

Outside diameter	3 mm	4 mm	6 mm	8 mm	10 mm	12 mm	14 mm	16 mm
Inside diameter	2.1 mm	2.6 mm	4 mm	5.7 mm	7 mm	8 mm	9.8 mm	11 mm
Pneumatic connection	For push-in connector outside diameter of 3 mm	For push-in connector O.D. 4 mm For barbed fitting I.D. 3 mm with union nut	For push-in connector O.D. 6 mm For barbed fitting I.D. 4 mm with union nut	For push-in connector O.D. 8 mm For barbed fitting inside diameter of 6 mm with union nut	For push-in connector O.D. 10 mm	For push-in connector outside diameter of 12 mm	For push-in connector outer diameter of 14 mm	For push-in connector O.D. 16 mm
Flow-relevant bending radius	12 mm	16 mm	26 mm	37 mm	52 mm	62 mm	78 mm	88 mm
Min. bending radius	6 mm	8 mm	10 mm	21 mm	28 mm	33 mm	38 mm	
Temperature-dependent operating pressure	-0.095 ... 1 MPa							
Temperature-dependent operating pressure	-0.95 ... 10 bar							
Temperature-dependent operating pressure	-13.775 ... 145 psi							
Operating pressure complete temperature range	-0.095 ... 0.6 MPa							
Operating pressure complete temperature range	-0.95 ... 6 bar							
Operating pressure complete temperature range	-13.775 ... 87 psi							
Note on operating pressure	Water: temperature-dependent operating pressure, see diagram, max. 0.3 MPa at 0 - 60°C							
Operating medium	Compressed air to ISO 8573-1:2010 [7:-] Water (liquid, ice-free)			Compressed air to ISO 8573-1:2010 [7:-] Water as per manufacturer's declaration at <a href="http://www.festo.com">www.festo.com</a> Water (liquid, ice-free)			Compressed air to ISO 8573-1:2010 [7:-] Water (liquid, ice-free)	
Suitable for use with food <sup>1)</sup>	See supplementary material information							
Ambient temperature	-35 ... 60°C							
Fire test material	UL94 HB							
Approval	German Technical Control Board (TÜV)							
Certificate issuing authority	B 013277 0506 00							
Tubing characteristics	Suitable for energy chains							

1) More information [www.festo.com/catalogue/pun-h](http://www.festo.com/catalogue/pun-h) → Support/Downloads.

## Datasheet

### Operating and environmental conditions – PUN-H-DUO

Outside diameter	4 mm	6 mm	8 mm	10 mm
Inside diameter	2.6 mm	4 mm	5.7 mm	7 mm
Pneumatic connection	For push-in connector O.D. 4 mm For barbed fitting I.D. 3 mm with union nut	For push-in connector O.D. 6 mm For barbed fitting I.D. 4 mm with union nut	For push-in connector O.D. 8 mm For barbed fitting inside diameter of 6 mm with union nut	For push-in connector O.D. 10 mm
Flow-relevant bending radius	16 mm	26 mm	37 mm	52 mm
Min. bending radius	8 mm	10 mm	21 mm	28 mm
Temperature-dependent operating pressure	-0.095 ... 1 MPa			
Temperature-dependent operating pressure	-0.95 ... 10 bar			
Temperature-dependent operating pressure	-13.775 ... 145 psi			
Operating pressure complete temperature range	-0.095 ... 0.6 MPa			
Operating pressure complete temperature range	-0.95 ... 6 bar			
Operating pressure complete temperature range	-13.775 ... 87 psi			
Note on operating pressure	Water: temperature-dependent operating pressure, see diagram, max. 0.3 MPa at 0 - 60°C			
Operating medium	Compressed air to ISO 8573-1:2010 [7:::] Water (liquid, ice-free)			
Suitable for use with food <sup>1)</sup>	See supplementary material information			
Ambient temperature	-35 ... 60°C			
Fire test material	UL94 HB			
Approval	German Technical Control Board (TÜV)			
Certificate issuing authority	B 013277 0506 00			
Tubing characteristics	Suitable for energy chains			

1) More information [www.festo.com/catalogue/pun-h](http://www.festo.com/catalogue/pun-h) → Support/Downloads.

### Operating pressure p as a function of temperature t

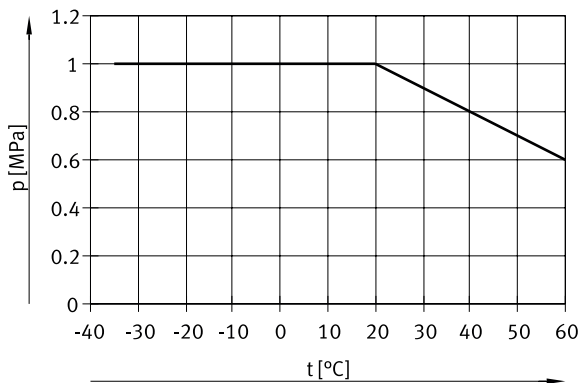

### Operating pressure p as a function of temperature t (medium: water)

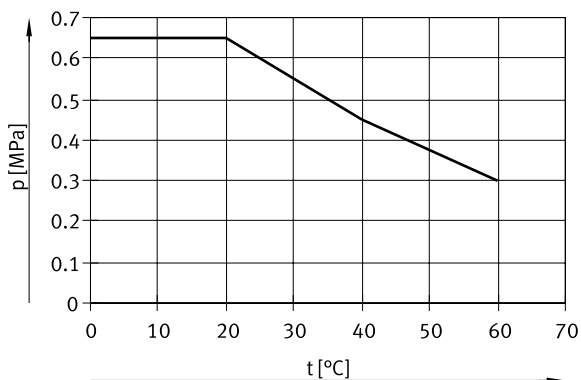

Deviating maximum operating pressures apply to the medium water, with a safety factor of  $s=4$ .

## Datasheet

Materials	
Shore hardness	D 52 +/-3
Material tubing	TPE-U(PU)
Note on materials	RoHS-compliant
LABS (PWIS) conformity <sup>1)</sup>	VDMA24364-B2-L
Suitability for the production of Li-ion batteries <sup>2)</sup>	Metals with more than 1% by mass of copper, zinc or nickel by mass are excluded from use. Exceptions are nickel in steel, chemically nickel-plated surfaces, printed circuit boards, cables, electrical plug connectors and coils
Instructions on use	TPE-U Ether based

1) Applies to PUN-H with O.D. 3 ... 16 mm and PUN-H-DUO

2) Applies to PUN-H with O.D. 3 ... 16 mm and PUN-H-DUO

## Dimensions

Dimensions – Reel

Download CAD data → [www.festo.com](http://www.festo.com)

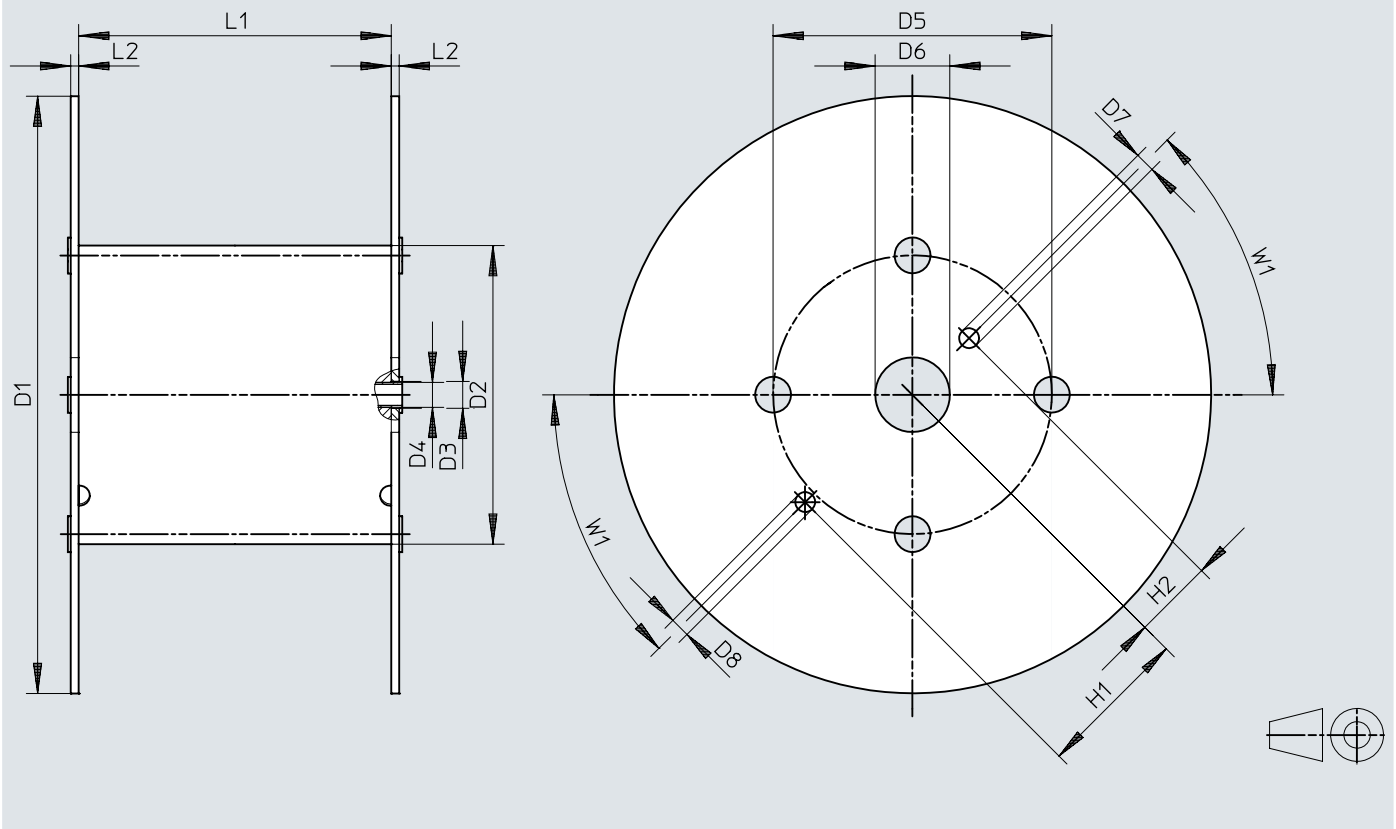

	D1 ∅	D2 ∅	D3 ∅	D4 ∅	D5 ∅	D6 ∅	D7 ∅	D8 ∅	H1	H2	L1	L2	W1
PUN-H-3x0,5-...-500	545	246	21	20	216	75	20	20	152,5	80,5	128	8	45°
PUN-H-4x0,75-...-500	545	246	21	20	216	75	20	20	152,5	80,5	128	8	45°
PUN-H-6x1-...-500	545	246	21	20	216	75	20	20	152,5	80,5	128	8	45°
PUN-H-8x1,25-...-400	545	310	21	20	280	75	20	20	152,5	80,5	254	8	45°
PUN-H-10x1,5-...-300	600	310	21	20	280	75	20	20	152,5	80,5	254	8	45°
PUN-H-12x2-...-200	600	310	21	20	280	75	20	20	152,5	80,5	254	8	45°
PUN-H-16x2,5-...-100	545	310	21	20	280	75	20	20	152,5	80,5	254	8	45°



## Ordering data

Ordering data PUN-H									
	Outside diameter	Packaging unit [m] <sup>1)</sup>	Product weight according to length	Colour	Part no.	Type			
	2 mm	Standard	0.002 kg/m	Natural	133038	PUN-H-2X0,4-NT			
				Red	133040	PUN-H-2X0,4-RT			
				Black	133039	PUN-H-2X0,4-SW			
	3 mm	500 m	0.004 kg/m	Blue	197382	PUN-H-3X0,5-BL			
				Yellow	558298	PUN-H-3X0,5-GE			
				Green	558291	PUN-H-3X0,5-GN			
				Natural	197375	PUN-H-3X0,5-NT			
				Red	558284	PUN-H-3X0,5-RT			
				Black	197389	PUN-H-3X0,5-SW			
				Silver	558277	PUN-H-3X0,5-SI			
				Blue	558256	PUN-H-3X0,5-BL-500			
				Natural	558263	PUN-H-3X0,5-NT-500			
				Black	558249	PUN-H-3X0,5-SW-500			
				Silver	558270	PUN-H-3X0,5-SI-500			
				4 mm	Standard	0.009 kg/m	Blue	★ 197383	PUN-H-4X0,75-BL
	Yellow	558299	PUN-H-4X0,75-GE						
	Green	558292	PUN-H-4X0,75-GN						
	Natural	★ 197376	PUN-H-4X0,75-NT						
	Red	★ 558285	PUN-H-4X0,75-RT						
	Black	★ 197390	PUN-H-4X0,75-SW						
	Silver	★ 558278	PUN-H-4X0,75-SI						
	Translucent blue	★ 8048671	PUN-H-4X0,75-TBL						
	Translucent yellow	8048679	PUN-H-4X0,75-TGE						
	Translucent green	8048677	PUN-H-4X0,75-TGN						
	Translucent red	8048675	PUN-H-4X0,75-TRT						
	Translucent black	8048673	PUN-H-4X0,75-TSW						
		8205512	PUN-H-4X0,75-BL-25						
	Red	8204445	PUN-H-4X0,75-RT-25						
	Black	8205515	PUN-H-4X0,75-SW-25						
	Translucent blue	8205518	PUN-H-4X0,75-TBL-25						
	Blue	★ 558257	PUN-H-4X0,75-BL-500						
	Natural	★ 558264	PUN-H-4X0,75-NT-500						
	Black	★ 558250	PUN-H-4X0,75-SW-500						
	Silver	★ 558271	PUN-H-4X0,75-SI-500						
	Translucent blue	★ 8048672	PUN-H-4X0,75-TBL-500						
	Translucent yellow	8048680	PUN-H-4X0,75-TGE-500						
	Translucent green	8048678	PUN-H-4X0,75-TGN-500						
	Translucent red	8048676	PUN-H-4X0,75-TRT-500						
	Translucent black	8048674	PUN-H-4X0,75-TSW-500						
	6 mm	Standard	0.018 kg/m				Blue	★ 197384	PUN-H-6X1-BL
							Yellow	558300	PUN-H-6X1-GE
							Green	558293	PUN-H-6X1-GN
Natural							★ 197377	PUN-H-6X1-NT	
Red							★ 558286	PUN-H-6X1-RT	
Black				★ 197391	PUN-H-6X1-SW				
Silver				★ 558279	PUN-H-6X1-SI				
Translucent blue				★ 8048681	PUN-H-6X1-TBL				
Translucent yellow				8048689	PUN-H-6X1-TGE				

Ordering data

Ordering data PUN-H								
	Outside diameter	Packaging unit [m] <sup>1)</sup>	Product weight according to length	Colour	Part no.	Type		
	6 mm	Standard	0.018 kg/m	Translucent green	8048687	PUN-H-6X1-TGN		
				Translucent red	8048685	PUN-H-6X1-TRT		
				Translucent black	8048683	PUN-H-6X1-TSW		
		25 m		Blue	8205513	PUN-H-6X1-BL-25		
				Red	8204446	PUN-H-6X1-RT-25		
				Black	8205516	PUN-H-6X1-SW-25		
				Translucent blue	8205519	PUN-H-6X1-TBL-25		
				500 m	Blue	★ 558258	PUN-H-6X1-BL-500	
					Natural	★ 558265	PUN-H-6X1-NT-500	
					Black	★ 558251	PUN-H-6X1-SW-500	
					Silver	★ 558272	PUN-H-6X1-SI-500	
					Translucent blue	★ 8048682	PUN-H-6X1-TBL-500	
		Translucent yellow			8048690	PUN-H-6X1-TGE-500		
		Translucent green		8048688	PUN-H-6X1-TGN-500			
		Translucent red		8048686	PUN-H-6X1-TRT-500			
		Translucent black		8048684	PUN-H-6X1-TSW-500			
		8 mm		Standard	0.029 kg/m	Blue	★ 197385	PUN-H-8X1,25-BL
						Yellow	558301	PUN-H-8X1,25-GE
	Green		558294			PUN-H-8X1,25-GN		
	Natural		★ 197378			PUN-H-8X1,25-NT		
	Red		★ 558287			PUN-H-8X1,25-RT		
	Black		★ 197392			PUN-H-8X1,25-SW		
	Silver		★ 558280			PUN-H-8X1,25-SI		
	Translucent blue		★ 8048691			PUN-H-8X1,25-TBL		
	Translucent yellow		8048699			PUN-H-8X1,25-TGE		
	Translucent green		8048697			PUN-H-8X1,25-TGN		
	Translucent red		8048695			PUN-H-8X1,25-TRT		
	Translucent black		8048693			PUN-H-8X1,25-TSW		
	25 m		Blue			8205514	PUN-H-8X1,25-BL-25	
			Red			8204447	PUN-H-8X1,25-RT-25	
			Black			8205517	PUN-H-8X1,25-SW-25	
			Translucent blue			8205520	PUN-H-8X1,25-TBL-25	
			400 m			Blue	★ 558259	PUN-H-8X1,25-BL-400
						Natural	★ 558266	PUN-H-8X1,25-NT-400
	Black			★ 558252		PUN-H-8X1,25-SW-400		
	Silver			★ 558273		PUN-H-8X1,25-SI-400		
	Translucent blue			★ 8048692		PUN-H-8X1,25-TBL-400		
	Translucent yellow			8048700		PUN-H-8X1,25-TGE-400		
	Translucent green			8048698		PUN-H-8X1,25-TGN-400		
	Translucent red			8048696		PUN-H-8X1,25-TRT-400		
	Translucent black			8048694		PUN-H-8X1,25-TSW-400		
	10 mm			Standard		0.046 kg/m	Blue	★ 197386
Yellow							558302	PUN-H-10X1,5-GE
Green							558295	PUN-H-10X1,5-GN
Natural			★ 197379				PUN-H-10X1,5-NT	
Red			★ 558288				PUN-H-10X1,5-RT	

## Ordering data

Ordering data PUN-H						
	Outside diameter	Packaging unit [m] <sup>1)</sup>	Product weight according to length	Colour	Part no.	Type
	10 mm	Standard	0.046 kg/m	Black	★ 197393	PUN-H-10X1,5-SW
				Silver	★ 558281	PUN-H-10X1,5-SI
				Translucent blue	★ 8048701	PUN-H-10X1,5-TBL
				Translucent yellow	8048709	PUN-H-10X1,5-TGE
				Translucent green	8048707	PUN-H-10X1,5-TGN
				Translucent red	8048705	PUN-H-10X1,5-TRT
				Translucent black	8048703	PUN-H-10X1,5-TSW
				Blue	8204441	PUN-H-10X1,5-BL-25
				Red	8204448	PUN-H-10X1,5-RT-25
		Black		8204443	PUN-H-10X1,5-SW-25	
		Translucent blue		8205521	PUN-H-10X1,5-TBL-25	
		Blue		★ 558260	PUN-H-10X1,5-BL-300	
		Natural		★ 558267	PUN-H-10X1,5-NT-300	
		Black		★ 558253	PUN-H-10X1,5-SW-300	
		Silver		★ 558274	PUN-H-10X1,5-SI-300	
		Translucent blue		★ 8048702	PUN-H-10X1,5-TBL-300	
		Translucent yellow		8048710	PUN-H-10X1,5-TGE-300	
		Translucent green		8048708	PUN-H-10X1,5-TGN-300	
	Translucent red	8048706	PUN-H-10X1,5-TRT-300			
	Translucent black	8048704	PUN-H-10X1,5-TSW-300			
	Blue	★ 197387	PUN-H-12X2-BL			
	Yellow	558303	PUN-H-12X2-GE			
	Green	558296	PUN-H-12X2-GN			
	Natural	★ 197380	PUN-H-12X2-NT			
	Red	★ 558289	PUN-H-12X2-RT			
	Black	★ 197394	PUN-H-12X2-SW			
	Silver	★ 558282	PUN-H-12X2-SI			
	Translucent blue	★ 8048711	PUN-H-12X2-TBL			
	Translucent yellow	8048719	PUN-H-12X2-TGE			
	Translucent green	8048717	PUN-H-12X2-TGN			
	Translucent red	8048715	PUN-H-12X2-TRT			
	Translucent black	8048713	PUN-H-12X2-TSW			
	Blue	8204442	PUN-H-12X2-BL-25			
	Red	8204449	PUN-H-12X2-RT-25			
	Black	8204444	PUN-H-12X2-SW-25			
	Translucent blue	8205522	PUN-H-12X2-TBL-25			
Blue	★ 558261	PUN-H-12X2-BL-200				
Natural	★ 558268	PUN-H-12X2-NT-200				
Black	★ 558254	PUN-H-12X2-SW-200				
Silver	★ 558275	PUN-H-12X2-SI-200				
Translucent blue	★ 8048712	PUN-H-12X2-TBL-200				
Translucent yellow	8048720	PUN-H-12X2-TGE-200				
Translucent green	8048718	PUN-H-12X2-TGN-200				
Translucent red	8048716	PUN-H-12X2-TRT-200				
Translucent black	8048714	PUN-H-12X2-TSW-200				

## Ordering data

Ordering data PUN-H						
	Outside diameter	Packaging unit [m] <sup>1)</sup>	Product weight according to length	Colour	Part no.	Type
	14 mm	Standard	0.091 kg/m	Blue	★ 570386	PUN-H-14X2-BL
				Natural	570388	PUN-H-14X2-NT
				Black	570387	PUN-H-14X2-SW
	16 mm		0.123 kg/m	Blue	★ 197388	PUN-H-16X2,5-BL
				Yellow	558304	PUN-H-16X2,5-GE
				Green	558297	PUN-H-16X2,5-GN
				Natural	★ 197381	PUN-H-16X2,5-NT
				Red	★ 558290	PUN-H-16X2,5-RT
				Black	★ 197395	PUN-H-16X2,5-SW
				Silver	★ 558283	PUN-H-16X2,5-SI
	100 m		Blue	★ 558262	PUN-H-16X2,5-BL-100	
			Natural	558269	PUN-H-16X2,5-NT-100	
			Black	558255	PUN-H-16X2,5-SW-100	
			Silver	558276	PUN-H-16X2,5-SI-100	

1) Standard: 50 m

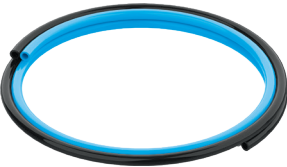
Ordering data PUN-H-DUO						
	Outside diameter	Packaging unit [m] <sup>1)</sup>	Product weight according to length	Colour	Part no.	Type
	4 mm	Standard	0.017 kg/m	Blue/black	197396	PUN-H-4X0,75-DUO
	6 mm		0.037 kg/m		197397	PUN-H-6X1-DUO
	8 mm		0.057 kg/m		197398	PUN-H-8X1,25-DUO
	10 mm		0.093 kg/m		197399	PUN-H-10X1,5-DUO

1) Standard: 50 m

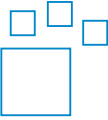
Ordering data – Modular product system			
	Short type code	Part no.	Type
	PUN, PUN-CM, PUN-H, PUN-V0, PUN-V0-C	553573	PUN