

Quick connector CK

FESTO

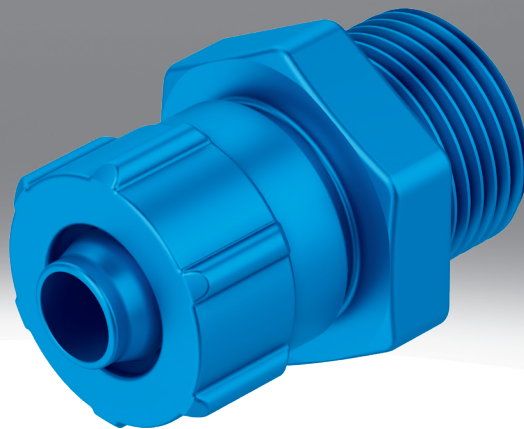

Datasheet

Technical data – Quick connector ACK

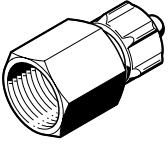

Mounting position	optional
Design	Straight design
Type of seal on screwed plug	Sealing ring
Operating pressure complete temperature range	-0.095 ... 1 MPa
Operating pressure complete temperature range	-0.95 ... 10 bar
Operating pressure complete temperature range	-13.775 ... 145 psi
Note on operating pressure	Water: max. 0.6 MPa at max. 50°C
Operating medium	Compressed air to ISO 8573-1:2010 [7:-:-], Water (liquid, ice-free)
Note on operating and pilot medium	Lubricated operation possible, Water: G-thread only possible with sealing ring type OL as additional accessory
Ambient temperature	-10 ... 60°C
Corrosion resistance class CRC ¹⁾	2 - Moderate corrosion stress
Material union nut	Wrought aluminium alloy, anodised
Material screwed plug	Anodised wrought aluminium alloy
Material sealing ring	Reinforced PA, TPE-U(PU)
Note on materials	RoHS-compliant
LABS (PWIS) conformity	VDMA24364-B1/B2-L

1) More information: www.festo.com/x/topic/crc

Datasheet

Technical data – Quick connector CK

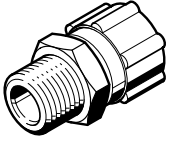

Pneumatic connection, port 1	Male thread M5	Male thread G1/8	Male thread G1/4	Male thread G3/8	Male thread G1/2
Mounting position	optional				
Design	Straight design				
Type of seal on screwed plug	Sealing ring				
Operating pressure complete temperature range	-0.095 ... 1 MPa				
Operating pressure complete temperature range	-0.95 ... 10 bar				
Operating pressure complete temperature range	-13.775 ... 145 psi				
Note on operating pressure	Water: max. 0.6 MPa at max. 50°C				
Operating medium	Compressed air to ISO 8573-1:2010 [7::-], Water (liquid, ice-free)				
Note on operating and pilot medium	Lubricated operation possible	Lubricated operation possible, Water: G-thread only possible with sealing ring type OL as additional accessory			Lubricated operation possible (in which case lubricated operation will always be required), Lubricated operation possible, Water: G-thread only possible with sealing ring type OL as additional accessory
Ambient temperature	-10 ... 60°C				
Corrosion resistance class CRC ¹⁾	1 - Low corrosion stress	2 - Moderate corrosion stress			
Material union nut	Wrought aluminium alloy, anodised				
Material screwed plug	Galvanised steel	Anodised wrought aluminium alloy			
Material sealing ring	NBR, High-alloy stainless steel	Reinforced PA, TPE-U(PU)			
Note on materials	RoHS-compliant				
LABS (PWIS) conformity	VDMA24364-B1/B2-L				

1) More information: www.festo.com/x/topic/crc

Datasheet

Technical data – Quick connector CK...-KU

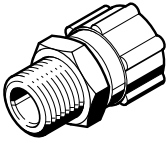

Mounting position	optional
Design	Straight design
Type of seal on screwed plug	Sealing edge
Operating pressure complete temperature range	-0.095 ... 1 MPa
Operating pressure complete temperature range	-0.95 ... 10 bar
Operating pressure complete temperature range	-13.775 ... 145 psi
Note on operating pressure	Water: max. 0.6 MPa at max. 50°C
Operating medium	Compressed air to ISO 8573-1:2010 [7:-:], Water (liquid, ice-free)
Note on operating and pilot medium	Lubricated operation possible
Ambient temperature	-10 ... 60°C
Material union nut	POM
Material screwed plug	POM
Note on materials	RoHS-compliant
LABS (PWIS) conformity	VDMA24364-B1/B2-L

Technical data – Bulkhead quick connector QCK

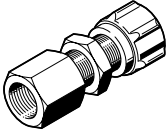

Mounting position	optional
Design	Bulkhead
Type of seal on screwed plug	Sealing ring
Operating pressure complete temperature range	-0.095 ... 1 MPa
Operating pressure complete temperature range	-0.95 ... 10 bar
Operating pressure complete temperature range	-13.775 ... 145 psi
Operating medium	Compressed air to ISO 8573-1:2010 [7:-:]
Note on operating and pilot medium	Lubricated operation possible
Ambient temperature	-10 ... 60°C
Corrosion resistance class CRC ¹⁾	1 - Low corrosion stress
Material union nut	Wrought aluminium alloy, anodised
Material nut	Galvanised steel
Material connector	Wrought aluminium alloy, anodised
Note on materials	RoHS-compliant
LABS (PWIS) conformity	VDMA24364-B1/B2-L

1) More information: www.festo.com/x/topic/crc

Datasheet

Technical data – Bulkhead quick connector SCK

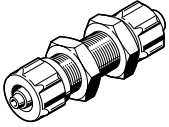

Material union nut	Wrought aluminium alloy, anodised
Mounting position	optional
Design	Bulkhead
Operating pressure complete temperature range	0 ... 1.6 MPa
Operating pressure complete temperature range	0 ... 16 bar
Operating pressure complete temperature range	0 ... 232 psi
Operating medium	Compressed air to ISO 8573-1:2010 [7:::]
Note on operating and pilot medium	Lubricated operation possible
Ambient temperature	-40 ... 150°C
Corrosion resistance class CRC ¹⁾	1 - Low corrosion stress
Material nut	Galvanised steel
Material connector	Wrought aluminium alloy, anodised
Note on materials	RoHS-compliant
LABS (PWIS) conformity	VDMA24364-B1/B2-L

1) More information: www.festo.com/x/topic/crc

Technical data – Bulkhead quick connector SCK...-KU

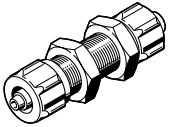

Material union nut	POM
Mounting position	optional
Design	Bulkhead
Operating pressure complete temperature range	-0.095 ... 1 MPa
Operating pressure complete temperature range	-0.95 ... 10 bar
Operating pressure complete temperature range	-13.775 ... 145 psi
Operating medium	Compressed air to ISO 8573-1:2010 [7:::]
Note on operating and pilot medium	Lubricated operation possible
Ambient temperature	-10 ... 60°C
Corrosion resistance class CRC ¹⁾	–
Material nut	POM
Material connector	POM
Note on materials	RoHS-compliant
LABS (PWIS) conformity	VDMA24364-B1/B2-L

1) More information: www.festo.com/x/topic/crc

Datasheet

Technical data – Sealing cap CV

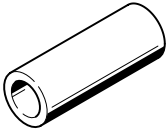

Temperature-dependent operating pressure	-0.095 ... 1 MPa
Temperature-dependent operating pressure	-0.95 ... 10 bar
Temperature-dependent operating pressure	-13.775 ... 145 psi
Operating medium	Compressed air to ISO 8573-1:2010 [7:-:]
Ambient temperature	-10 ... 80°C
Material cap	TPE-U(PU)
Note on materials	RoHS-compliant
LABS (PWIS) conformity	VDMA24364-B2-L

Technical data – Sealing cap CV-PC-8

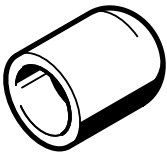

Operating medium	Compressed air to ISO 8573-1:2010 [7:-:]
Ambient temperature	-10 ... 60°C
Note on materials	RoHS-compliant
LABS (PWIS) conformity	VDMA24364-B2-L

Technical data – Elbow quick connector GCK-...-KU

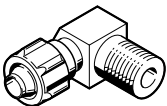

Mounting position	optional
Design	L-shape
Operating pressure complete temperature range	-0.095 ... 1 MPa
Operating pressure complete temperature range	-0.95 ... 10 bar
Operating pressure complete temperature range	-13.775 ... 145 psi
Operating medium	Compressed air to ISO 8573-1:2010 [7:-:]
Note on operating and pilot medium	Lubricated operation possible
Ambient temperature	-10 ... 60°C
Material union nut	POM
Material screwed plug	POM
Note on materials	RoHS-compliant
LABS (PWIS) conformity	VDMA24364-B1/B2-L

Datasheet

Technical data – Elbow quick connector LCK

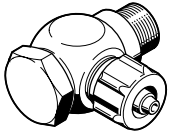

Material hollow bolt	Wrought aluminium alloy, anodised	Galvanised steel
Mounting position	optional	
Design	L-shape	
Type of seal on screwed plug	Sealing ring	
Operating pressure complete temperature range	-0.095 ... 1 MPa	
Operating pressure complete temperature range	-0.95 ... 10 bar	
Operating pressure complete temperature range	-13.775 ... 145 psi	
Operating medium	Compressed air to ISO 8573-1:2010 [7:::]	
Note on operating and pilot medium	Lubricated operation possible	
Ambient temperature	-10 ... 60°C	
Corrosion resistance class CRC ¹⁾	1 - Low corrosion stress	
Material union nut	Wrought aluminium alloy, anodised	
Material sealing ring	Reinforced PA, TPE-U(PU)	NBR, High-alloy stainless steel
Note on materials	RoHS-compliant	
LABS (PWIS) conformity	VDMA24364-B1/B2-L	

1) More information: www.festo.com/x/topic/crc

Technical data – Elbow quick connector LCK...-KU

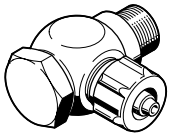

Mounting position	optional	
Design	L-shape	
Type of seal on screwed plug	Sealing edge	
Operating pressure complete temperature range	-0.095 ... 1 MPa	
Operating pressure complete temperature range	-0.95 ... 10 bar	
Operating pressure complete temperature range	-13.775 ... 145 psi	
Operating medium	Compressed air to ISO 8573-1:2010 [7:::]	
Note on operating and pilot medium	Lubricated operation possible	
Ambient temperature	-10 ... 60°C	
Corrosion resistance class CRC ¹⁾	2 - Moderate corrosion stress	
Material union nut	POM	
Material hollow bolt	Wrought aluminium alloy, anodised	

1) More information: www.festo.com/x/topic/crc

Datasheet

Technical data – T quick connector TCK

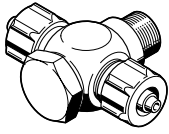

Material hollow bolt	Wrought aluminium alloy, anodised	Galvanised steel
Mounting position	optional	
Note on materials	RoHS-compliant	
Design	T-shape	
Type of seal on screwed plug	Sealing ring	
Operating pressure complete temperature range	-0.095 ... 1 MPa	
Operating pressure complete temperature range	-0.95 ... 10 bar	
Operating pressure complete temperature range	-13.775 ... 145 psi	
Operating medium	Compressed air to ISO 8573-1:2010 [7:::]	
Note on operating and pilot medium	Lubricated operation possible	
Ambient temperature	-10 ... 60°C	
Corrosion resistance class CRC ¹⁾	1 - Low corrosion stress	
Material union nut	Wrought aluminium alloy, anodised	
Material sealing ring	Reinforced PA, TPE-U(PU)	NBR, High-alloy stainless steel
Material housing	Die-cast zinc	
Material swivel fitting	Die-cast zinc	
LABS (PWIS) conformity	VDMA24364-B1/B2-L	

1) More information: www.festo.com/x/topic/crc

Technical data – T quick connector TCK-...-KU

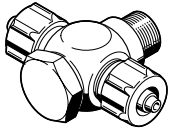

Mounting position	optional	
Design	T-shape	
Type of seal on screwed plug	Sealing edge	
Operating pressure complete temperature range	-0.095 ... 1 MPa	
Operating pressure complete temperature range	-0.95 ... 10 bar	
Operating pressure complete temperature range	-13.775 ... 145 psi	
Operating medium	Compressed air to ISO 8573-1:2010 [7:::]	
Note on operating and pilot medium	Lubricated operation possible	
Ambient temperature	-10 ... 60°C	
Corrosion resistance class CRC ¹⁾	2 - Moderate corrosion stress	
Material union nut	POM	
Material hollow bolt	Wrought aluminium alloy, anodised	
Material housing	POM	
Material swivel fitting	POM	
Note on materials	RoHS-compliant	
LABS (PWIS) conformity	VDMA24364-B1/B2-L	

1) More information: www.festo.com/x/topic/crc

Datasheet

Technical data – T-distributor FCK

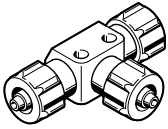

Mounting position	optional
Design	T-shape
Operating pressure complete temperature range	-0.095 ... 1 MPa
Operating pressure complete temperature range	-0.95 ... 10 bar
Operating pressure complete temperature range	-13.775 ... 145 psi
Operating medium	Compressed air to ISO 8573-1:2010 [7:-:-]
Note on operating and pilot medium	Lubricated operation possible
Ambient temperature	-10 ... 60°C
Corrosion resistance class CRC ¹⁾	–
Material union nut	POM
Material housing	–
Note on materials	RoHS-compliant
LABS (PWIS) conformity	VDMA24364-B1/B2-L

1) More information: www.festo.com/x/topic/crc

Technical data – Union nut MCK

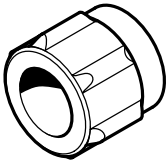

Operating pressure complete temperature range	-0.095 ... 1.2 MPa
Operating pressure complete temperature range	-0.95 ... 12 bar
Operating pressure complete temperature range	-13.775 ... 174 psi
Ambient temperature	-10 ... 60°C
Note on materials	RoHS-compliant
LABS (PWIS) conformity	VDMA24364-B2-L

Dimensions

Dimensions – Quick connector ACK

Download CAD data www.festo.com

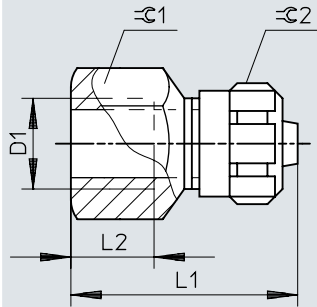

	D1	L1	L2	$\varnothing 1$	$\varnothing 2$
ACK-1/8-PK-3	G1/8	23,9	9	13	8
ACK-1/8-PK-4		27	9	13	12
ACK-1/8-PK-6		27	9	13	14
ACK-1/4-PK-4	G1/4	30	12	17	12
ACK-1/4-PK-6		30	12	17	14
ACK-3/8-PK-6	G3/8	31	12	19	14
ACK-3/8-PK-9		37,4	15	19	19
ACK-1/2-PK-13	G1/2	40,2	15	27	24

Dimensions

Dimensions – Quick connector CK

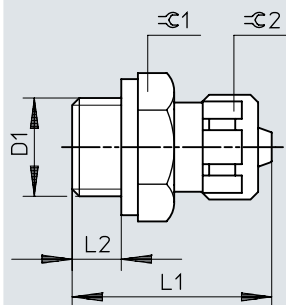
Download CAD data www.festo.com

	D1	L1	L2	$\varnothing C1$	$\varnothing C2$
CK-M5-PK-3	M5	19,3	3,8	7	8
CK-M5-PK-4		21,5	3,8	10	–
CK-1/8-PK-3	G1/8	21,6	4,9	13	8
CK-1/8-PK-4		24,7	4,9	13	12
CK-1/8-PK-6		24,8	4,9	13	14
CK-1/4-PK-4	G1/4	27,2	5,8	17	12
CK-1/4-PK-6		27,3	5,8	17	14
CK-1/4-PK-9		30,6	5,8	17	19
CK-3/8-PK-6	G3/8	28,3	6,8	19	14
CK-3/8-PK-9		31,6	6,8	19	19
CK-3/8-PK-13		33,2	6,8	24	24
CK-1/2-PK-13	G1/2	34,7	8,5	24	24

Dimensions

Dimensions – Quick connector CK ... KU

Download CAD data www.festo.com

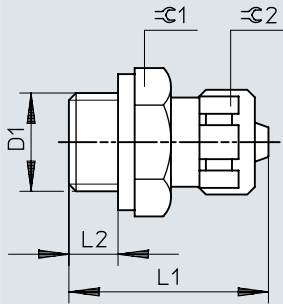

	D1	L1	L2	Ø1	Ø2
CK-1/8-PK-3-KU	G1/8	22,2	6,5	13	8
CK-1/8-PK-4-KU		25,3	6,5	13	12
CK-1/8-PK-6-KU		25,4	6,5	13	14
CK-1/4-PK-4-KU	G1/4	28,5	8,5	17	12
CK-1/4-PK-6-KU		28,6	8,5	17	14
CK-1/4-PK-9-KU		31,9	8,5	17	19
CK-3/8-PK-6-KU	G3/8	31	10,5	19	14
CK-3/8-PK-9-KU		34,5	10,5	19	19

Dimensions

Dimensions – Bulkhead quick connector QCK

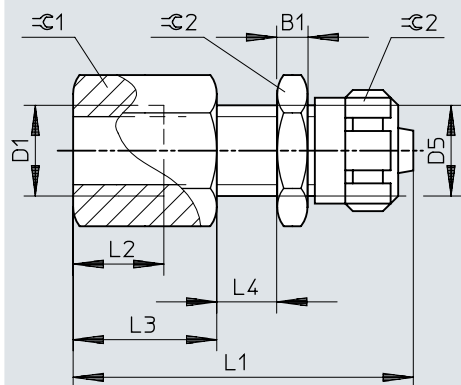
Download CAD data www.festo.com

	D1	B1	D5	L1	L2	L3	L4 max.	⌀1	⌀2	⌀3
QCK-M5-PK-3-B	M5	3,2	M6x0,75	31	6	10	8	7	8	10
QCK-1/8-PK-4-B	G1/8	3,5	M10x1	40	8	13,5	10	13	12	13
QCK-1/4-PK-6-B	G1/4	4	M12x1	45	12	18	10	17	14	17
QCK-3/8-PK-9-B	G3/8	5	M16x1	50	12	18,6	10	19	19	22

Dimensions

Dimensions – Bulkhead quick connector SCK/SCK-...-KU

Download CAD data www.festo.com

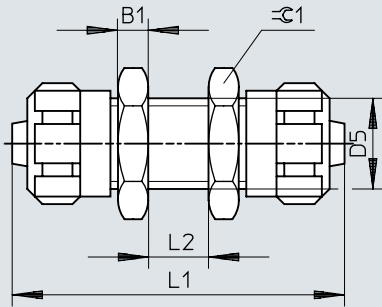

	B1	D5	L1	L2 max.	≅C1
SCK-PK-3	3,2	M6x0,75	34	8	10
SCK-PK-4	3,5	M10x1	43	10	13
SCK-PK-6	4	M12x1	44	10	17
SCK-PK-9	5	M16x1	53	10	22
SCK-PK-3-KU	5	M10x1 ¹⁾	41	10	13
SCK-PK-4-KU	5	M10x1	46	10	13
SCK-PK-6-KU	6	M12x1	48	10	17
SCK-PK-9-KU	7	M16x1	57	10	22

1) Mounting diameter differs from the aluminium version

Dimensions

Dimensions – Elbow quick connector GCK-...-KU

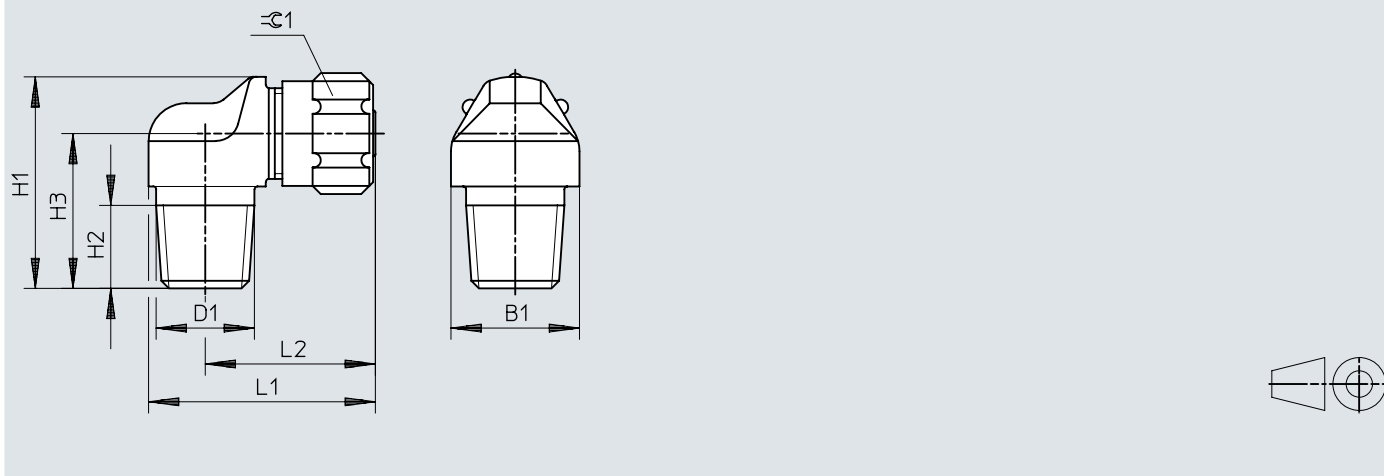
Download CAD data www.festo.com

	D1	B1	H1	H2	H3	L1	L2	≅C1
GCK-1/8-PK-4-KU	R1/8	13	22,5	8	16,5	26,5	20,5	12
GCK-1/8-PK-6-KU		17	24,5	8	17,5	28,5	21,5	14
GCK-1/4-PK-4-KU	R1/4	17	25,5	11	19,5	30	22,5	12
GCK-1/4-PK-6-KU		17	27,5	11	20,5	30	22,5	14
GCK-3/8-PK-6-KU	R3/8	19	28,5	10,5	21	34	24,5	14
GCK-3/8-PK-9-KU		19	33,5	10,5	23,5	37,2	27,7	19

Dimensions

Dimensions – Elbow quick connector LCK/LCK...-KU

Download CAD data www.festo.com

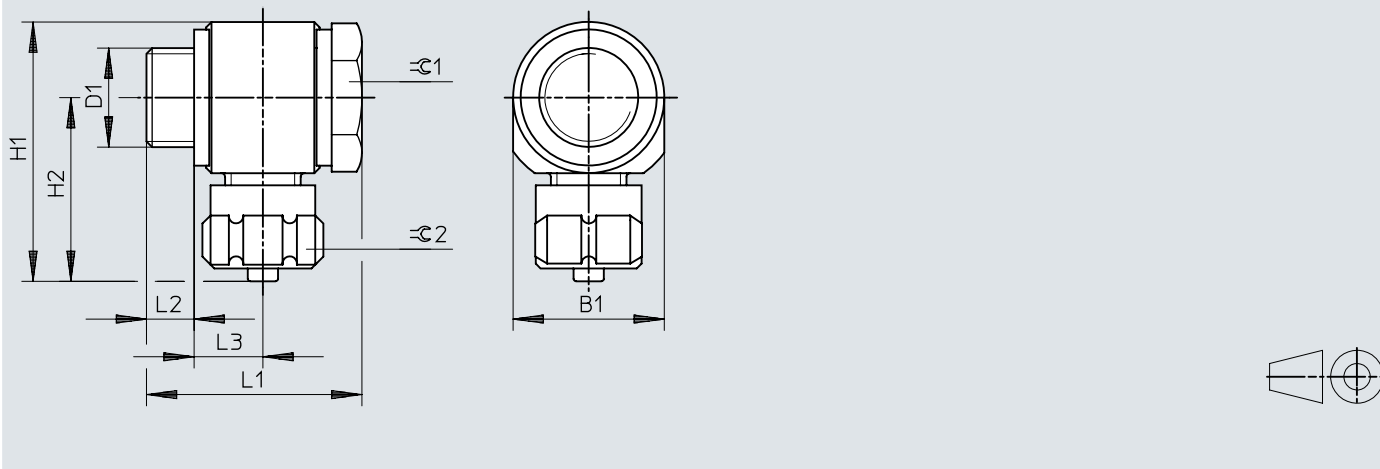

	D1	B1	H1	H2	L1	L2	L3	≙C1	≙C2
LCK-M5-PK-3	M5	10	21,1	16,1	17,2	3,8	5,2	7	8
LCK-M5-PK-4		11	21,1	16,1	18	3,8	5,6	7	8
LCK-1/8-PK-3	G1/8	16	27,1	19,1	21,1	4,9	6,1	13	8
LCK-1/8-PK-4		16	30,2	22,2	27,1	4,9	9,1	13	12
LCK-1/8-PK-6	G1/4	16	30,3	22,3	27,1	4,9	9,1	13	14
LCK-1/4-PK-4		20	34,2	24,2	28,1	5,7	9,2	17	12
LCK-1/4-PK-6		20	34,3	24,3	28,1	5,5	9,3	17	14
LCK-1/4-PK-9	G3/8	20	37,6	27,6	33,3	5,7	11,8	17	19
LCK-3/8-PK-6		25	39,3	26,8	30,3	6,7	9,3	22	14
LCK-3/8-PK-9	G1/2	25	42,6	30,1	35,3	6,7	11,8	22	19
LCK-1/2-PK-13		30	49,2	34,2	46,6	7,9	16,85	27	24
LCK-1/8-PK-4-KU	G1/8	16	30,5	22,5	27,5	7,1	8,25	13	12
LCK-1/8-PK-6-KU		16	30,5	22,5	27,5	7,1	8,25	13	14
LCK-1/4-PK-4-KU	G1/4	20	34,5	24,5	28,5	8,1	8,25	17	12
LCK-1/4-PK-6-KU		20	34,5	24,5	28,5	8,1	8,25	17	14

Dimensions

Dimensions – T quick connector TCK/TCK-...-KU

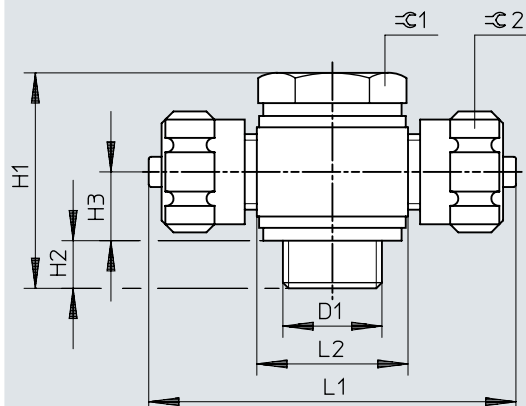
Download CAD data www.festo.com

	D1	H1	H2	H3	L1	L2	$\varnothing 1$	$\varnothing 2$
TCK-M5-PK-3	M5	17,2	3,8	5,2	32,2	10	7	8
TCK-M5-PK-4		18	3,8	5,6	39,4	11	7	8
TCK-1/8-PK-3	G1/8	21,1	4,9	6,1	38,2	16	13	8
TCK-1/8-PK-4		27,1	4,9	9,1	44,4	16	13	12
TCK-1/8-PK-6		27,1	4,9	9,1	44,6	16	13	14
TCK-1/4-PK-4	G1/4	28,1	5,7	9,2	48,4	20	17	12
TCK-1/4-PK-6		28,1	5,5	9,3	48,6	20	17	14
TCK-3/8-PK-6	G3/8	30,3	6,7	9,3	53,6	25	22	14
TCK-3/8-PK-9		35,3	6,7	11,8	60,2	25	22	14
TCK-1/2-PK-13	G1/2	46,6	7,9	16,9	68,4	30	27	24
TCK-1/8-PK-4-KU	G1/8	27,5	7,1	8,25	45	16	13	12
TCK-1/8-PK-6-KU		27,5	7,1	8,25	45	16	13	14
TCK-1/4-PK-4-KU	G1/4	28,5	8,1	8,25	49	20	17	12
TCK-1/4-PK-6-KU		28,5	8,1	8,25	49	20	17	14

Dimensions

Dimensions – T-distributor FCK-...-KU

Download CAD data www.festo.com

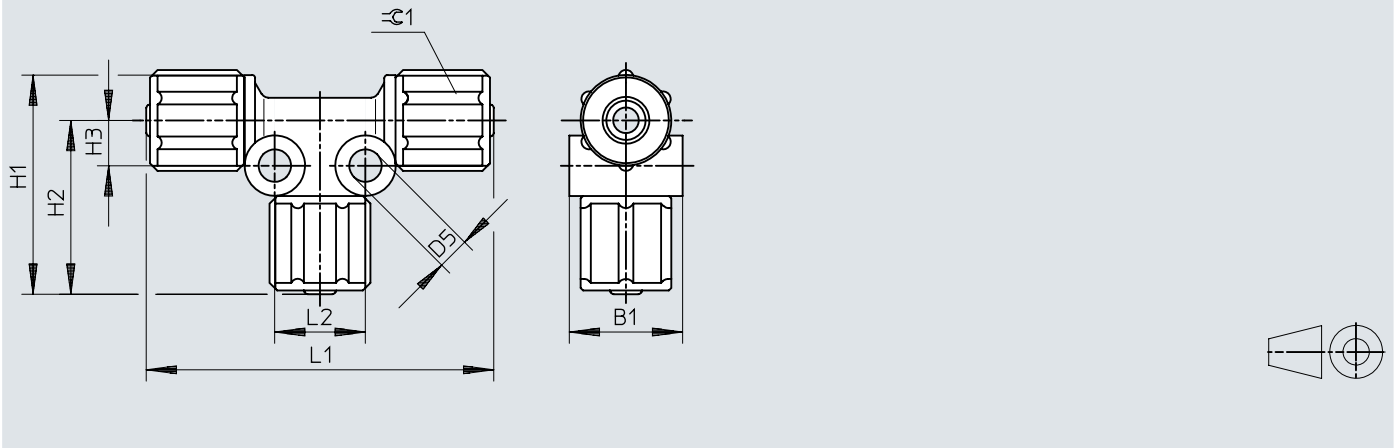

	B1	D5	H1	H2	H3	L1	L2	±0.1
FCK-3-PK-3-KU	11	4,3	23,8	19,8	5	39,6	10	8
FCK-3-PK-4-KU	15	4,3	30,2	24,2	6	48,4	12	12
FCK-3-PK-6-KU	18	4,3	31,2	24,2	6	48,4	12	14
FCK-3-PK-9-KU	22	4,3	38,3	28,8	7,1	56,4	13	19

Dimensions

Dimensions – Union nut MCK

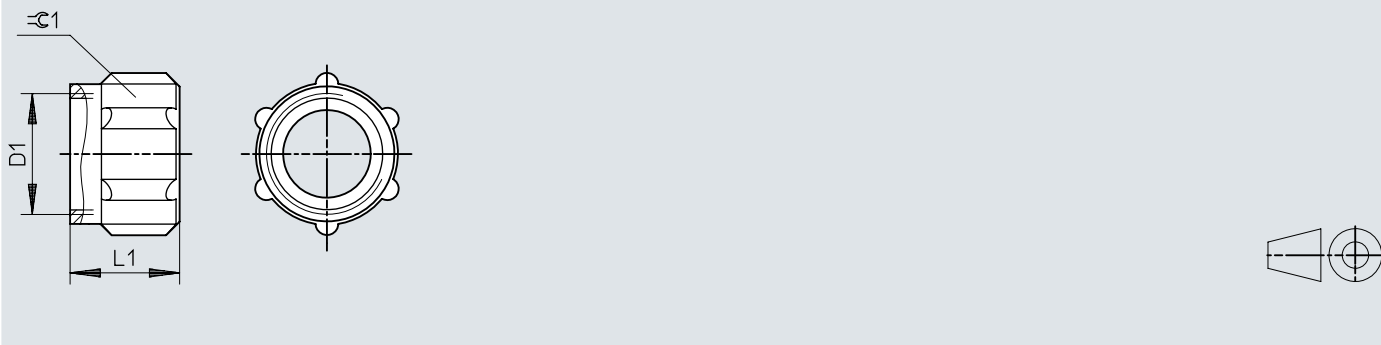
Download CAD data www.festo.com

	D1	L1	\varnothing 1
MCK-PK-3	M6x0,75	8,5	8
MCK-PK-4 ¹⁾	M10x1	11	12
MCK-PK-4-R ²⁾	M8x1	9,5	–
MCK-PK-6	M12x1	11	14
MCK-PK-9	M16x1	14,4	19
MCK-PK-13	M22x1	18	24
MCK-PK-3-KU	M6x0,75	9,5	8
MCK-PK-4-KU ¹⁾	M10x1	12,5	12
MCK-PK-6-KU	M12x1	12,5	14
MCK-PK-9-KU	M16x1	16	19

1) excluding fittings CK-M5-PK-4, LCK-M5-PK-4, TCK-M5-PK-4

2) For CK-M5-PK-4, LCK-M5-PK-4, TCK-M5-PK-4 fittings

Ordering data

Ordering data – Quick connector ACK						
	Pneumatic connection, port 1	Pneumatic connection, port 2	Nominal size	Size of pack	Part no.	Type
	Female thread G1/8	For tubing outside diameter of 4 mm, For barbed fitting I.D. 3 mm with nut	2.4 mm	10	5664	ACK-1/8-PK-3
		For tubing outside diameter of 6 mm, For barbed fitting inside diameter of 4 mm with nut	3.4 mm		3714	ACK-1/8-PK-4
		For tubing outside diameter of 8 mm, For barbed fitting inside diameter of 6 mm with nut	5.3 mm		7842	ACK-1/8-PK-6
	Female thread G1/4	For tubing outside diameter of 6 mm, For barbed fitting inside diameter of 4 mm with nut	3.4 mm		3713	ACK-1/4-PK-4
		For tubing outside diameter of 8 mm, For barbed fitting inside diameter of 6 mm with nut	5.3 mm		3712	ACK-1/4-PK-6
	Female thread G3/8	For barbed fitting inside diameter of 9 mm with nut	8 mm		3711	ACK-3/8-PK-6
		For barbed fitting I.D. 13 mm with nut	12 mm	4099	ACK-1/2-PK-13	

Ordering data – Quick connector CK						
	Pneumatic connection, port 1	Pneumatic connection, port 2	Nominal size	Size of pack	Part no.	Type
	Male thread M5	For tubing outside diameter of 4 mm, For barbed fitting I.D. 3 mm with nut	2 mm	10	3561	CK-M5-PK-3
		For tubing outside diameter of 6 mm, For barbed fitting inside diameter of 4 mm with nut	2.9 mm		3562	CK-M5-PK-4
	Male thread G1/8	For tubing outside diameter of 4 mm, For barbed fitting I.D. 3 mm with nut	2 mm		3563	CK-1/8-PK-3
		For tubing outside diameter of 6 mm, For barbed fitting inside diameter of 4 mm with nut	2.9 mm		2027	CK-1/8-PK-4

Ordering data

Ordering data – Quick connector CK						
	Pneumatic connection, port 1	Pneumatic connection, port 2	Nominal size	Size of pack	Part no.	Type
	Male thread G1/8	For tubing outside diameter of 8 mm, For barbed fitting inside diameter of 6 mm with nut	4.9 mm	10	2028	CK-1/8-PK-6
	Male thread G1/4	For tubing outside diameter of 6 mm, For barbed fitting inside diameter of 4 mm with nut	2.9 mm		2029	CK-1/4-PK-4
		For tubing outside diameter of 8 mm, For barbed fitting inside diameter of 6 mm with nut	4.9 mm		2030	CK-1/4-PK-6
		For barbed fitting inside diameter of 9 mm with nut	8 mm		2031	CK-1/4-PK-9
	Male thread G3/8	For tubing outside diameter of 8 mm, For barbed fitting inside diameter of 6 mm with nut	4.9 mm		2032	CK-3/8-PK-6
		For barbed fitting inside diameter of 9 mm with nut	8 mm		2033	CK-3/8-PK-9
		For barbed fitting I.D. 13 mm with nut	11.7 mm		4097	CK-3/8-PK-13
	Male thread G1/2				4098	CK-1/2-PK-13

Ordering data – Quick connector CK...-KU						
	Pneumatic connection, port 1	Pneumatic connection, port 2	Nominal size	Size of pack	Part no.	Type
	Male thread G1/8	For tubing outside diameter of 4 mm, For barbed fitting I.D. 3 mm with nut	2.4 mm	10	6253	CK-1/8-PK-3-KU
		For tubing outside diameter of 6 mm, For barbed fitting inside diameter of 4 mm with nut	3.4 mm		6254	CK-1/8-PK-4-KU
		For tubing outside diameter of 8 mm, For barbed fitting inside diameter of 6 mm with nut	4.4 mm		6255	CK-1/8-PK-6-KU
	Male thread G1/4	For tubing outside diameter of 6 mm, For barbed fitting inside diameter of 4 mm with nut	3.4 mm		6256	CK-1/4-PK-4-KU

Ordering data

Ordering data – Quick connector CK-...-KU						
	Pneumatic connection, port 1	Pneumatic connection, port 2	Nominal size	Size of pack	Part no.	Type
	Male thread G1/4	For tubing outside diameter of 8 mm, For barbed fitting inside diameter of 6 mm with nut	5.3 mm	10	6257	CK-1/4-PK-6-KU
		For barbed fitting inside diameter of 9 mm with nut	7.3 mm		6258	CK-1/4-PK-9-KU
	Male thread G3/8	For tubing outside diameter of 8 mm, For barbed fitting inside diameter of 6 mm with nut	5.3 mm		6460	CK-3/8-PK-6-KU
		For barbed fitting inside diameter of 9 mm with nut	8 mm		6468	CK-3/8-PK-9-KU

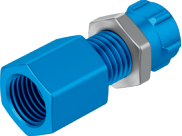
Ordering data – Bulkhead quick connector QCK						
	Pneumatic connection, port 1	Pneumatic connection, port 2	Nominal size	Size of pack	Part no.	Type
	Female thread M5	For tubing outside diameter of 4 mm, For barbed fitting I.D. 3 mm with nut	2.4 mm	10	9424	QCK-M5-PK-3-B
	Female thread G1/8	For tubing outside diameter of 6 mm, For barbed fitting inside diameter of 4 mm with nut	3.4 mm		9425	QCK-1/8-PK-4-B
	Female thread G1/4	For tubing outside diameter of 8 mm, For barbed fitting inside diameter of 6 mm with nut	5.3 mm		9426	QCK-1/4-PK-6-B
	Female thread G3/8	For barbed fitting inside diameter of 9 mm with nut	8 mm		9427	QCK-3/8-PK-9-B

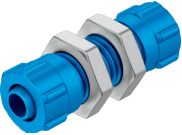
Ordering data – Bulkhead quick connector SCK						
	Pneumatic connection, port 1	Pneumatic connection, port 2	Nominal size	Size of pack	Part no.	Type
	For tubing outer diameter of 4 mm, For barbed fitting I.D. 3 mm with union nut	For tubing outside diameter of 4 mm, For barbed fitting I.D. 3 mm with nut	2.4 mm	10	9420	SCK-PK-3
	For tubing outside diameter of 6 mm, For barbed fitting I.D. 4 mm with union nut	For tubing outside diameter of 6 mm, For barbed fitting inside diameter of 4 mm with nut	3.4 mm		9421	SCK-PK-4
	For tubing outer diameter of 8 mm, For barbed fitting I.D. 6 mm with union nut	For tubing outside diameter of 8 mm, For barbed fitting inside diameter of 6 mm with nut	5.3 mm		9422	SCK-PK-6

Ordering data

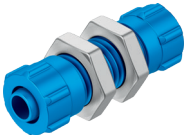
Ordering data – Bulkhead quick connector SCK						
	Pneumatic connection, port 1	Pneumatic connection, port 2	Nominal size	Size of pack	Part no.	Type
	For barbed fitting inside diameter of 9 mm with union nut	For barbed fitting inside diameter of 9 mm with nut	8 mm		9423	SCK-PK-9

Ordering data – Bulkhead quick connector SCK...-KU						
	Pneumatic connection, port 1	Pneumatic connection, port 2	Nominal size	Size of pack	Part no.	Type
	For tubing outer diameter of 4 mm, For barbed fitting I.D. 3 mm with union nut	For tubing outside diameter of 4 mm, For barbed fitting I.D. 3 mm with nut	2.4 mm	10	9387	SCK-PK-3-KU
	For tubing outside diameter of 6 mm, For barbed fitting I.D. 4 mm with union nut	For tubing outside diameter of 6 mm, For barbed fitting inside diameter of 4 mm with nut	3.4 mm		9388	SCK-PK-4-KU
	For tubing outer diameter of 8 mm, For barbed fitting I.D. 6 mm with union nut	For tubing outside diameter of 8 mm, For barbed fitting inside diameter of 6 mm with nut	5.3 mm		9389	SCK-PK-6-KU
	For barbed fitting inside diameter of 9 mm with union nut	For barbed fitting inside diameter of 9 mm with nut	8 mm		9390	SCK-PK-9-KU

Ordering data – Sealing cap CV					
	Pneumatic connection, port 1	Size of pack	Part no.	Type	
	For tubing outer diameter of 4 mm, For barbed fitting I.D. 3 mm with union nut	10	6213	CV-PK-3-B	
	For tubing outside diameter of 6 mm, For barbed fitting I.D. 4 mm with union nut		6214	CV-PK-4-B	
	For tubing outer diameter of 8 mm, For barbed fitting I.D. 6 mm with union nut		6215	CV-PK-6-B	
	For barbed fitting inside diameter of 9 mm with union nut		6216	CV-PK-9-B	

Ordering data – Sealing cap CV				
	Short type code	Size of pack	Part no.	Type
	CV	100	7637	CV-PC-8

Ordering data

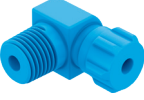
Ordering data – Elbow quick connector GCK...-KU						
	Pneumatic connection, port 1	Pneumatic connection, port 2	Nominal size	Size of pack	Part no.	Type
	Male thread R1/8	For tubing outside diameter of 6 mm, For barbed fitting inside diameter of 4 mm with nut	2.9 mm	10	6267	GCK-1/8-PK-4-KU
		For tubing outside diameter of 8 mm, For barbed fitting inside diameter of 6 mm with nut	4.9 mm		6268	GCK-1/8-PK-6-KU
	Male thread R1/4	For tubing outside diameter of 6 mm, For barbed fitting inside diameter of 4 mm with nut	2.9 mm		6269	GCK-1/4-PK-4-KU
		For tubing outside diameter of 8 mm, For barbed fitting inside diameter of 6 mm with nut	4.9 mm		6270	GCK-1/4-PK-6-KU
	Male thread R3/8	For tubing outside diameter of 8 mm, For barbed fitting inside diameter of 6 mm with nut	8 mm		6271	GCK-3/8-PK-6-KU
		For barbed fitting inside diameter of 9 mm with nut			6272	GCK-3/8-PK-9-KU

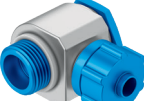
Ordering data – Elbow quick connector LCK						
	Pneumatic connection, port 1	Pneumatic connection, port 2	Nominal size	Size of pack	Part no.	Type
	Male thread M5	For tubing outside diameter of 4 mm, For barbed fitting I.D. 3 mm with nut	2.4 mm	10	4468	LCK-M5-PK-3
		For tubing outside diameter of 6 mm, For barbed fitting inside diameter of 4 mm with nut			4562	LCK-M5-PK-4
	Male thread G1/8	For tubing outside diameter of 4 mm, For barbed fitting I.D. 3 mm with nut	2 mm		4136	LCK-1/8-PK-3
		For tubing outside diameter of 6 mm, For barbed fitting inside diameter of 4 mm with nut	2.9 mm		4469	LCK-1/8-PK-4
		For tubing outside diameter of 8 mm, For barbed fitting inside diameter of 6 mm with nut	4.9 mm		4470	LCK-1/8-PK-6

Ordering data

Ordering data – Elbow quick connector LCK						
	Pneumatic connection, port 1	Pneumatic connection, port 2	Nominal size	Size of pack	Part no.	Type
	Male thread G1/4	For tubing outside diameter of 6 mm, For barbed fitting inside diameter of 4 mm with nut	2.9 mm	10	4471	LCK-1/4-PK-4
		For tubing outside diameter of 8 mm, For barbed fitting inside diameter of 6 mm with nut	4.9 mm		4472	LCK-1/4-PK-6
		For barbed fitting inside diameter of 9 mm with nut	8 mm		11452	LCK-1/4-PK-9
	Male thread G3/8	For tubing outside diameter of 8 mm, For barbed fitting inside diameter of 6 mm with nut	4.9 mm		4473	LCK-3/8-PK-6
		For barbed fitting inside diameter of 9 mm with nut	8 mm		4474	LCK-3/8-PK-9
	Male thread G1/2	For barbed fitting I.D. 13 mm with nut	11.7 mm		4100	LCK-1/2-PK-13

Ordering data – Elbow quick connector LCK...-KU						
	Pneumatic connection, port 1	Pneumatic connection, port 2	Nominal size	Size of pack	Part no.	Type
	Male thread G1/8	For tubing outside diameter of 6 mm, For barbed fitting inside diameter of 4 mm with nut	3.4 mm	10	6259	LCK-1/8-PK-4-KU
		For tubing outside diameter of 8 mm, For barbed fitting inside diameter of 6 mm with nut	5.3 mm		6260	LCK-1/8-PK-6-KU
	Male thread G1/4	For tubing outside diameter of 6 mm, For barbed fitting inside diameter of 4 mm with nut	3.4 mm		6261	LCK-1/4-PK-4-KU
		For tubing outside diameter of 8 mm, For barbed fitting inside diameter of 6 mm with nut	5.3 mm		6262	LCK-1/4-PK-6-KU

Ordering data

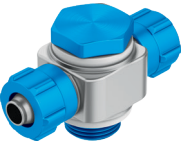
Ordering data – T quick connector TCK						
	Pneumatic connection, port 1	Pneumatic connection, port 2	Nominal size	Size of pack	Part no.	Type
	Male thread M5	For tubing outside diameter of 4 mm, For barbed fitting I.D. 3 mm with nut	2 mm	10	4484	TCK-M5-PK-3
		For tubing outside diameter of 6 mm, For barbed fitting inside diameter of 4 mm with nut			4563	TCK-M5-PK-4
	Male thread G1/8	For tubing outside diameter of 4 mm, For barbed fitting I.D. 3 mm with nut	2.9 mm		4137	TCK-1/8-PK-3
		For tubing outside diameter of 6 mm, For barbed fitting inside diameter of 4 mm with nut			4485	TCK-1/8-PK-4
		For tubing outside diameter of 8 mm, For barbed fitting inside diameter of 6 mm with nut			4486	TCK-1/8-PK-6
	Male thread G1/4	For tubing outside diameter of 6 mm, For barbed fitting inside diameter of 4 mm with nut	2.9 mm		4487	TCK-1/4-PK-4
		For tubing outside diameter of 8 mm, For barbed fitting inside diameter of 6 mm with nut			4488	TCK-1/4-PK-6
	Male thread G3/8	For tubing outside diameter of 8 mm, For barbed fitting inside diameter of 6 mm with nut	4.9 mm		4489	TCK-3/8-PK-6
		For barbed fitting inside diameter of 9 mm with nut			8 mm	4490
	Male thread G1/2	For barbed fitting I.D. 13 mm with nut	11.7 mm		4101	TCK-1/2-PK-13

Ordering data – T quick connector TCK...-KU						
	Pneumatic connection, port 1	Pneumatic connection, port 2	Nominal size	Size of pack	Part no.	Type
	Male thread G1/8	For tubing outside diameter of 6 mm, For barbed fitting inside diameter of 4 mm with nut	3.4 mm	10	6263	TCK-1/8-PK-4-KU
		For tubing outside diameter of 8 mm, For barbed fitting inside diameter of 6 mm with nut	5.3 mm		6264	TCK-1/8-PK-6-KU

Ordering data

Ordering data – T quick connector TCK...-KU

	Pneumatic connection, port 1	Pneumatic connection, port 2	Nominal size	Size of pack	Part no.	Type
	Male thread G1/4	For tubing outside diameter of 6 mm, For barbed fitting inside diameter of 4 mm with nut	3.4 mm	10	6265	TCK-1/4-PK-4-KU
		For tubing outside diameter of 8 mm, For barbed fitting inside diameter of 6 mm with nut	5.3 mm		6266	TCK-1/4-PK-6-KU

Ordering data – T-distributor FCK

	Pneumatic connection, port 1	Pneumatic connection, port 2	Nominal size	Size of pack	Part no.	Type
	For tubing outer diameter of 4 mm, For barbed fitting I.D. 3 mm with union nut	For tubing outside diameter of 4 mm, For barbed fitting I.D. 3 mm with nut	2.4 mm	10	6273	FCK-3-PK-3-KU
		For tubing outside diameter of 6 mm, For barbed fitting I.D. 4 mm with union nut	3.4 mm		6274	FCK-3-PK-4-KU
		For tubing outer diameter of 8 mm, For barbed fitting I.D. 6 mm with union nut	5.3 mm		6275	FCK-3-PK-6-KU
		For barbed fitting inside diameter of 9 mm with union nut	8 mm		6276	FCK-3-PK-9-KU

Ordering data – Union nut MCK

	Pneumatic connection, port 1	Material union nut	Corrosion resistance class CRC	Part no.	Type
	For tubing outer diameter of 4 mm, For barbed fitting I.D. 3 mm with union nut	Wrought aluminium alloy, anodised	2 - Moderate corrosion stress	205254	MCK-PK-3
		Nickel-plated wrought aluminium alloy	1 - Low corrosion stress	533672	MCK-PK-3-KD
		POM		211289	MCK-PK-3-KU
	For tubing outside diameter of 6 mm, For barbed fitting I.D. 4 mm with union nut	Wrought aluminium alloy, anodised	2 - Moderate corrosion stress	205257	MCK-PK-4-R
		Nickel-plated wrought aluminium alloy	1 - Low corrosion stress	533673	MCK-PK-4-KD
		POM		211291	MCK-PK-4-KU
	For tubing outer diameter of 8 mm, For barbed fitting I.D. 6 mm with union nut	Wrought aluminium alloy, anodised	2 - Moderate corrosion stress	2966	MCK-PK-6
		Nickel-plated wrought aluminium alloy	1 - Low corrosion stress	533674	MCK-PK-6-KD
		POM		211292	MCK-PK-6-KU
	For barbed fitting inside diameter of 9 mm with union nut	Wrought aluminium alloy, anodised	2 - Moderate corrosion stress	2967	MCK-PK-9

Ordering data

Ordering data – Union nut MCK					
	Pneumatic connection, port 1	Material union nut	Corrosion resistance class CRC	Part no.	Type
	For barbed fitting inside diameter of 9 mm with union nut	Nickel-plated wrought aluminium alloy	1 - Low corrosion stress	533675	MCK-PK-9-KD
		POM		211293	MCK-PK-9-KU
	For barbed connector I.D. 13 mm with union nut	Wrought aluminium alloy, anodised	2 - Moderate corrosion stress	206504	MCK-PK-13