

Adapter for grippers





Accessories

Adapter kit
HAPG, HMSV

Material:
Wrought aluminium alloy
RoHS-compliant

 **Note**
The kit includes the individual mounting interface as well as the necessary mounting material.

Permissible drive/gripper combinations with adapter kit Download CAD data → www.festo.com

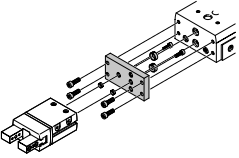
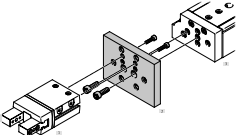
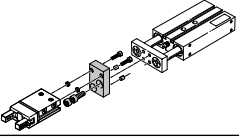
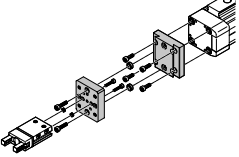
Combination	Drive Size	Gripper Size	Mounting option		Adapter kit		
					CRC ¹⁾	Part no.	Type
	DGST	DHPS			DHAA		
	6	6	■	■	2	8161981	DHAA-G-G8-6-B18-6
	8	6	■	■		8161977	DHAA-G-G8-8-B18-6
	10	10	■	■		8161979	DHAA-G-G8-10-B18-10
	12	10	■	■		8161978	DHAA-G-G8-12-B18-10
	16	16	■	■		8161980	DHAA-G-G8-16-B18-16
	20	20	■	■		8161976	DHAA-G-G8-20-B18-20
25	25	■	■	8161975		DHAA-G-G8-25-B18-25	
	DGSL	DHPS			HMSV		
	4, 6	6	■	■	2	548783	HMSV-53
	8, 10	10	■	■		548784	HMSV-54
	12, 16	16	■	■		548785	HMSV-55
20, 25	20, 25	■	■	548786		HMSV-56	
	DPZ	DHPS			HAPG		
	10, 16	10	■	–	2	163250	HAPG-1
	16	16, 20	■	–		163251	HAPG-2
	20	16, 20	■	–		163252	HAPG-3
25, 32	25	■	–	163253		HAPG-4	
	DGPL	DHPS			HMVA, HAPG, HMSV		
	Direct mounting						
	25, 32	6	■	■	2	196788	HMVA-DLA1 8/25
						192706	HAPG-37-S1
	40	6	■	■		196790	HMVA-DLA40
						192706	HAPG-37-S1
	25, 32	10	■	■		196788	HMVA-DLA1 8/25
						192705	HAPG-36-S1
	40	10	■	■		196790	HMVA-DLA40
						192705	HAPG-36-S1
	25, 32	16	■	■		196788	HMVA-DLA1 8/25
				193922		HAPG-37-S4	
40	16	■	■	196790		HMVA-DLA40	
				193922	HAPG-37-S4		



1) More information: www.festo.com/x/topic/crc

Accessories

Adapter kit
DHAA, HAPG

Material:
Wrought aluminium alloy
RoHS-compliant

 **Note**
The kit includes the individual mounting interface as well as the necessary mounting material.

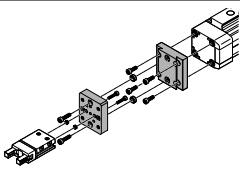
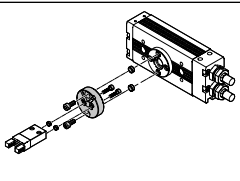
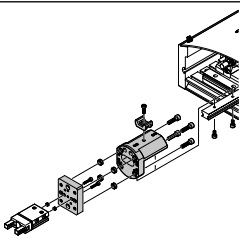
Permissible drive/gripper combinations with adapter kit							Download CAD data → www.festo.com	
Combination	Drive Size	Gripper Size	Mounting option		Adapter kit			
					CRC ¹⁾	Part no.	Type	
DGPL/DHPS	DGPL	DHPS				HMVA, HAPG, HMSV		
	Dovetail mounting					2	196788	HMVA-DLA18/25
	25	10	■	■	177767		HMSV-27	
	40	10	■	■	196790		HMVA-DLA40	
					177767		HMSV-27	
	25	16	■	■	196788		HMVA-DLA18/25	
					177768		HMSV-28	
	40	16	■	■	196790		HMVA-DLA40	
					177768		HMSV-28	
40	25	■	■	196790	HMVA-DLA40			
				177769	HMSV-29			
	40	35	■	■	196790	HMVA-DLA40		
					177770	HMSV-30		
DRRD/DHPS	DRRD	DHPS				DHAA		
	8	6	■	■	2	2808892	DHAA-G-Q11-8-B1-6	
	10	6	■	■		2807644	DHAA-G-Q11-10-B1-6	
	12	6	■	■		2805783	DHAA-G-Q11-12-B1-6	
	12	10	■	■		2802687	DHAA-G-Q11-12-B1-10	
	16	10	■	■		2190504	DHAA-G-Q11-16-B1-10	
	16	16	■	■		2190393	DHAA-G-Q11-16-B1-16	
	16	20	■	■		2187838	DHAA-G-Q11-16-B1-20	
	20	16	■	■		2190284	DHAA-G-Q11-20-B1-16	
	20	20	■	■		2187713	DHAA-G-Q11-20-B1-20	
	20	25	■	■		2185820	DHAA-G-Q11-20-B1-25	
	25	16	■	■		1471634	DHAA-G-Q11-25-B1-16	
	25	20	■	■		1722652	DHAA-G-Q11-25-B1-20	
	25	25	■	■		1725707	DHAA-G-Q11-25-B1-25	
	32	25	■	■		2186909	DHAA-G-Q11-32-B1-25	
	32	35	■	■		2187316	DHAA-G-Q11-32-B1-35	
	35, 40	35	■	■		2187606	DHAA-G-Q11-35/40-B1-35	
HSP/DHPS	HSP	DHPS			HAPG			
	12	6	■	–	2	192709	HAPG-60-S1	
						540881	HAPG-70-B	
	16	6	■	–		192706	HAPG-37-S1	
						540882	HAPG-71-B	
	16	10	■	–		192705	HAPG-36-S1	
						540882	HAPG-71-B	
	25	10	■	–		192705	HAPG-36-S1	
						540883	HAPG-72-B	
25	16	■	–	193922	HAPG-37-S4			
				540883	HAPG-72-B			

1) More information: www.festo.com/x/topic/crc

Adapter for parallel gripper DHPS

Accessories



Adapter kit
DHAA, HAPG

Material:
Wrought aluminium alloy
RoHS-compliant

 **Note**
The kit includes the individual mounting interface as well as the necessary mounting material.

Permissible drive/gripper combinations with adapter kit

Download CAD data → www.festo.com

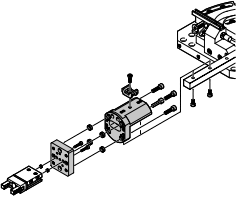
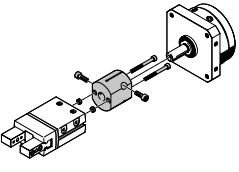
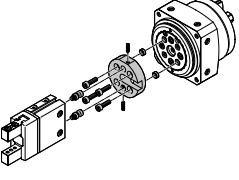
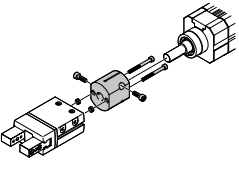
Combination	Drive Size	Gripper Size	Mounting option		Adapter kit				
					CRC ¹⁾	Part no.	Type		
	12, 16	6	■	–	2	192706	HAPG-37-S1		
			■	–		540882	HAPG-71-B		
	12, 16	10	■	–		192705	HAPG-36-S1		
			■	–		540882	HAPG-71-B		
	6, 8, 10	6	■	■	2	187568	HAPG-34		
	DSM-...	DHPS	12	10	■	■	2	163266	HAPG-17
			16	10	■	■		163267	HAPG-18
			16	16, 20	■	■		163268	HAPG-19
			25	16, 20	■	■		163269	HAPG-20
			25	25	■	■		163270	HAPG-21
			32	25	■	■		163271	HAPG-22
	DSM-...-HD	DHPS	12	6	■	■	2	8071899	DHAA-G-R3-12-B18-6
			12	10	■	■		8072157	DHAA-G-R3-12-B18-10
			16	10	■	■		8071917	DHAA-G-R3-16-B18-10
			16	16	■	■		8079173	DHAA-G-R3-16-B18-16
			25	16, 20	■	■		8071956	DHAA-G-R3-25-B18-16
			32	25	■	■		8079208	DHAA-G-R3-32-B18-25
				DSL	DHPS	16		10	■
20	10	■				■	163267	HAPG-18	
20	16, 20	■				■	163268	HAPG-19	
25	16, 20	■				■	163269	HAPG-20	
25	25	■				■	163270	HAPG-21	
32	25	■				■	163271	HAPG-22	

1) More information: www.festo.com/x/topic/crc



Accessories

Adapter kit
DHAA, HAPG, HMSV

Material:
Wrought aluminium alloy
RoHS-compliant

 **Note**

The kit includes the individual mounting interface as well as the necessary mounting material.

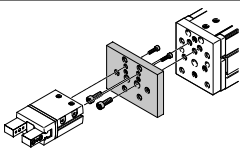
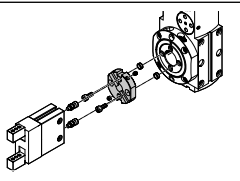
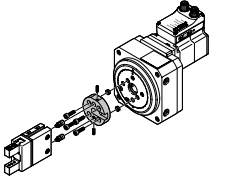
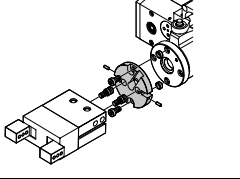
Permissible drive/gripper combinations with adapter kit						Download CAD data → www.festo.com	
Combination	Drive Size	Gripper Size	Mounting option		Adapter kit CRC ¹⁾	Part no.	Type
							
EGSL/DHPS	EGSL	DHPS			HMSV		
	35	6	■	■	2	548783	HMSV-53
	35	10	■	■		1088262	HMSV-70
	45, 55	16	■	■		548784	HMSV-54
	75	20, 25	■	■		1088262	HMSV-70
						548785	HMSV-55
						548786	HMSV-56
ERMB/DHPS	ERMB	DHPS			HAPG		
	20	16, 20	■	■	2	184479	HAPG-SD2-3
	25	16, 20	■	■		184482	HAPG-SD2-6
	20	25	■	■		184480	HAPG-SD2-4
	25	25	■	■		184483	HAPG-SD2-7
	32	25	■	■		184485	HAPG-SD2-9
	32	35	■	■		184486	HAPG-SD2-10
ERMO/DHPS	ERMO	DHPS			DHAA		
	12	6	■	■	2	8071899	DHAA-G-R3-12-B18-6
	12	10	■	■		8072157	DHAA-G-R3-12-B18-10
	16	10	■	■		8071917	DHAA-G-R3-16-B18-10
	16	16	■	■		8079173	DHAA-G-R3-16-B18-16
	25	16, 20	■	■		8071956	DHAA-G-R3-25-B18-16
	32	25	■	■		8079208	DHAA-G-R3-32-B18-25
EHMB/DHPS	EHMB	DHPS			HAPG		
	20	25	■	■	2	184485	HAPG-SD2-9
	20	35	■	■		184486	HAPG-SD2-10
	25, 32	35	■	■		526027	HAPG-SD2-21

1) More information: www.festo.com/x/topic/crc

Adapter for parallel gripper HGPD, sealed

Accessories

Adapter kit
DHAA



Material:
Wrought aluminium alloy
RoHS-compliant

 **Note**

The kit includes the individual mounting interface as well as the necessary mounting material.

Permissible drive/gripper combinations with adapter kit

Download CAD data → www.festo.com

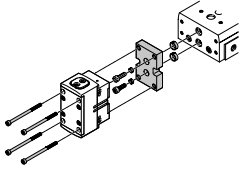
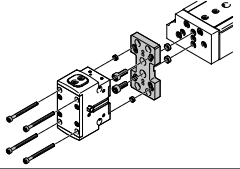
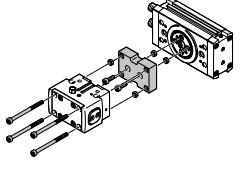
Combination	Drive Size	Gripper Size	Mounting option		Adapter kit CRC ¹⁾	Part no.	Type
							
	DGST	HGPD			DHAA		
	10	16	–	■	2	8163132	DHAA-G-G8-10-B12-16
	12	20	–	■		8163129	DHAA-G-G8-12-B12-20
	16	25	–	■		8163133	DHAA-G-G8-16-B12-25
	20	35	–	■		8163131	DHAA-G-G8-20-B12-35
	25	40	–	■		8163130	DHAA-G-G8-25-B12-40
	DGSL	HGPD			DHAA, HAPG		
	8, 10	16, 20	■	■	2	564957	DHAA-G-G6-8-B8-16
	12, 16	16, 20	■	■		564954	DHAA-G-G6-16-B8-16
	12, 16	25	■	■		564952	DHAA-G-G6-16-B8-25
	20, 25	25, 35	■	■		537175	HAPG-79
	20, 25	40	■	■		564951	DHAA-G-G6-20-B8-40
	DRRD	HGPD			DHAA		
	12	16	■	■	2	2449935	DHAA-G-Q11-12-B12-16
	12	20	■	■		2449945	DHAA-G-Q11-12-B12-20
	16	16	■	■		2091914	DHAA-G-Q11-16-B12/B12G-16
	16	20	■	■		2091205	DHAA-G-Q11-16-B12-20
	16	25	■	■		2090715	DHAA-G-Q11-16-B12-25
	20	25	■	■		2088381	DHAA-G-Q11-20-B12-25
	20	35	■	■		2088008	DHAA-G-Q11-20-B12-35
	25	35	■	■		1714646	DHAA-G-Q11-25-B12-35
	25	40	■	■		1715576	DHAA-G-Q11-25-B12-40
	32	40	■	■		2092197	DHAA-G-Q11-32-B12-40
	35	40	■	■		2114998	DHAA-G-Q11-35-B12-40
	32	50	■	■		2124051	DHAA-G-Q11-32-B12-50
	35, 40	50	■	■		2124346	DHAA-G-Q11-35/40-B12-50
	40	63	■	■		2125614	DHAA-G-Q11-40-B12-63
	50	63	■	■		2352692	DHAA-G-Q11-50-B12-63
50	80	■	■		2412840	DHAA-G-Q11-50-B12-80	

1) More information: www.festo.com/x/topic/crc



Accessories

Adapter kit
DHAA, HAPG

Material:
Wrought aluminium alloy
RoHS-compliant

 **Note**

The kit includes the individual mounting interface as well as the necessary mounting material.

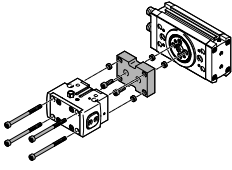
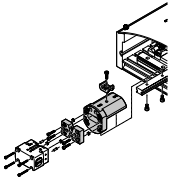
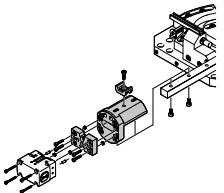
Permissible drive/gripper combinations with adapter kit					Download CAD data → www.festo.com		
Combination	Drive Size	Gripper Size	Mounting option		Adapter kit CRC ¹⁾	Part no.	Type
							
	DRRD	HGPD-...-G1/G2			DHAA		
	12	16	■	■	2	2798991	DHAA-G-Q11-12-B12G-16
	12	20	■	■		2800963	DHAA-G-Q11-12-B12G-20
	16	20	■	■		2642948	DHAA-G-Q11-16-B12G-20
	16	25	■	■		2642941	DHAA-G-Q11-16-B12G-25
	20	25	■	■		2642953	DHAA-G-Q11-20-B12G-25
	20	35	■	■		2642961	DHAA-G-Q11-20-B12G-35
	25	35	■	■		2642962	DHAA-G-Q11-25-B12G-35
	25	40	■	■		2642966	DHAA-G-Q11-25-B12G-40
	32	40	■	■		2642967	DHAA-G-Q11-32-B12G-40
	32	50	■	■		2642969	DHAA-G-Q11-32-B12G-50
	35	40	■	■		2643047	DHAA-G-Q11-35-B12G-40
	35, 40	50	■	■		2643100	DHAA-G-Q11-3 5/40-B12G-50
	40	63	■	■		2643055	DHAA-G-Q11-40-B12G-63
	50	63	■	■		2643096	DHAA-G-Q11-50-B12G-63
50	80	■	■		2643098	DHAA-G-Q11-50-B12G-80	
	HSP	HGPD			DHAA, HAPG		
	12	16	■	–	2	564957	DHAA-G-G6-8-B8-16
						540881	HAPG-70-B
	16	16, 20	■	–		564957	DHAA-G-G6-8-B8-16
						540882	HAPG-71-B
25	16, 20	■	–		564957	DHAA-G-G6-8-B8-16	
					540883	HAPG-72-B	
	HSW	HGPD			DHAA, HAPG		
	12, 16	16	■	–	2	564957	DHAA-G-G6-8-B8-16
						540882	HAPG-71-B
	16	20	■	–		564957	DHAA-G-G6-8-B8-16
						540882	HAPG-71-B

1) More information: www.festo.com/x/topic/crc

Adapter for parallel gripper HGPD, sealed



Accessories

Adapter kit
DHAA, HAPG

Material:
Wrought aluminium alloy
RoHS-compliant

 **Note**
The kit includes the individual mounting interface as well as the necessary mounting material.

Permissible drive/gripper combinations with adapter kit Download CAD data → www.festo.com

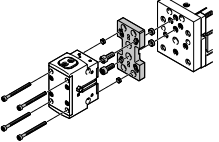
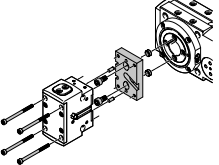
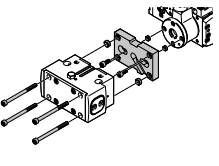
Combination	Drive Size	Gripper Size	Mounting option		Adapter kit CRC ¹⁾	Part no.	Type
							
EGSL/HGPD 	EGSL	HGPD			DHAA, HAPG		
	45, 55	25	■	■	2	564952	DHAA-G-G6-16-B8-25
	75	25, 35	■	■		537175	HAPG-79
	75	40	■	■		564951	DHAA-G-G6-20-B8-40
ERMB/HGPD 	ERMB	HGPD			DHAA, HAPG		
	20	25	■	■	2	537181	HAPG-SD2-25
	20, 25	35	■	■		537173	HAPG-SD2-23
	25, 32	40	■	■		537184	HAPG-SD2-26
	32	50	■	■		564956	DHAA-G-Q5-32-B8-50
EHMB/HGPD 	EHMB	HGPD			DHAA, HAPG		
	20	40	■	■	2	537184	HAPG-SD2-26
	20, 25, 32	50	■	■		564956	DHAA-G-Q5-32-B8-50
	25, 32	63	■	■		537188	HAPG-SD2-28

1) More information: www.festo.com/x/topic/crc



Accessories

Adapter kit
DHAA, HAPG, HMSV, HMVA

Material:
Wrought aluminium alloy
RoHS-compliant

 **Note**
The kit includes the individual mounting interface as well as the necessary mounting material.

Permissible drive/gripper combinations with adapter kit Download CAD data → www.festo.com

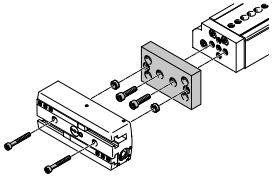
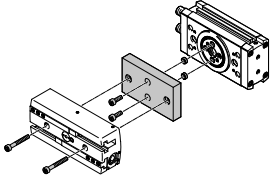
Combination	Drive Size	Gripper Size	Mounting option		Adapter kit		
					CRC ¹⁾	Part no.	Type
DGSL/HGPL	DGSL	HGPL			DHAA, HAPG		
	16	14-20	■	■	2	2406159	DHAA-G-G6-16-B6-14
	20, 25	14-20	■	■		2410181	DHAA-G-G6-20-B6-14
	16	14-40, 14-60, 14-80	■	■		538055	HAPG-89
	20, 25	14-40, 14-60, 14-80	■	■		539274	HAPG-90
	25	25	■	■		539274	HAPG-90
	16	14-20	■	■	2	2019271	DHAA-G-Q11-16-B6-14-20
	16	14-40	■	■		2019618	DHAA-G-Q11-16-B6-14-40
	16	14-60, 14-80	■	■		2019640	DHAA-G-Q11-16-B6-14-60/80
	20	14-20	■	■		2018509	DHAA-G-Q11-20-B6-14-20
	20	14-40	■	■		2018553	DHAA-G-Q11-20-B6-14-40
	20	14-60, 14-80	■	■		2018986	DHAA-G-Q11-20-B6-14-60/80
	25	14-20	■	■		1813646	DHAA-G-Q11-25-B6-14-20
	25	14-40	■	■		1734087	DHAA-G-Q11-25-B6-14-40
	25	14-60, 14-80	■	■		2018453	DHAA-G-Q11-25-B6-14-60/80
	25	25-20, 25-40	■	■		1794882	DHAA-G-Q11-25-B6-25-20/40
	25	25-60, 25-80	■	■		2020149	DHAA-G-Q11-25-B6-25-60/80
	32	25-20, 25-40	■	■		2021733	DHAA-G-Q11-32-B6-25-20/40
	32	25-60, 25-80	■	■		2022377	DHAA-G-Q11-32-B6-25-60/80
	35	25-20, 25-40	■	■		2022892	DHAA-G-Q11-35-B6-25-20/40
	35	25-60, 25-80	■	■		2023095	DHAA-G-Q11-35-B6-25-60/80
	35, 40	40-20	■	■		2023665	DHAA-G-Q11-35/40-B6-40-20
	35, 40	40-40, 40-60	■	■		2024121	DHAA-G-Q11-35/40-B6-40-40/60
	35, 40	40-80, 40-100	■	■		2024947	DHAA-G-Q11-35/40-B6-40-80/100
	50	40-20	■	■		2387903	DHAA-G-Q11-50-B6-40-20
	50	40-40, 40-60, 40-80, 40-100	■	■		2431288	DHAA-G-Q11-50-B6-40-40/60/80/100
50	63-60, 63-100, 63-150	■	■	2431624	DHAA-G-Q11-50-B6-63-60/100/150		

1) More information: www.festo.com/x/topic/crc

Adapter for heavy-duty parallel gripper HGPL-B with long stroke



Accessories

Adapter kit
DHAA, HAPG

Material:
Wrought aluminium alloy
RoHS-compliant

 **Note**
The kit includes the individual mounting interface as well as the necessary mounting material.

Download CAD data → www.festo.com

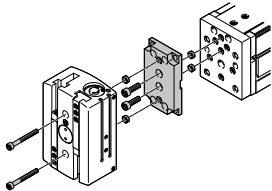
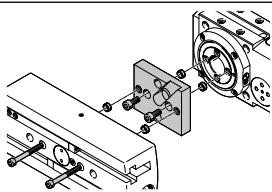
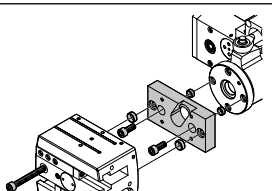
Permissible drive/gripper combinations with adapter kit							
Combination	Drive Size	Gripper Size	Mounting option		Adapter kit		
					CRC ¹⁾	Part no.	Type
EGSL/HGPL	EGSL	HGPL			DHAA, HAPG		
	45, 55	14-20	■	■	2	2406159	DHAA-G-G6-16-B6-14
	75	14-20	■	■		2410181	DHAA-G-G6-20-B6-14
	45, 55	14-40, 14-60, 14-80	■	■		538055	HAPG-89
	75	14-40, 14-60, 14-80	■	■		539274	HAPG-90
	75	25	■	■		539274	HAPG-90
ERMB/HGPL	ERMB	HGPL			HAPG		
	20	14-40, 14-60, 14-80	■	■	2	537310	HAPG-SD2-31
	25, 32	25	■	■		537311	HAPG-SD2-29
EHMB/HGPL	EHMB	HGPL			DHAA, HAPG		
	25	40-20	■	■	2	2436852	DHAA-G-H2-25-B6-40
	20	25	■	■		537311	HAPG-SD2-29
	25	40-40, 40-60, 40-80, 40-100	■	■		537312	HAPG-SD2-30

1) More information: www.festo.com/x/topic/crc

Accessories



Adapter kit
HAPG

Material:
Wrought aluminium alloy
RoHS-compliant

 **Note**

The kit includes the individual mounting interface as well as the necessary mounting material.

Permissible drive/gripper combinations with adapter kit Download CAD data → www.festo.com

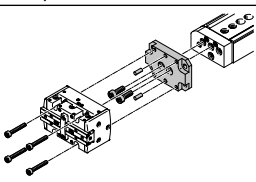
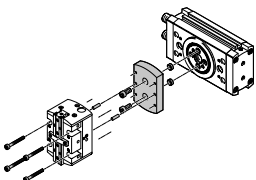
Combination	Drive Size	Gripper Size	Mounting option		Adapter kit		
					CRC ¹⁾	Part no.	Type
	DGSL	HGPP			HAPG		
	8, 10	10	■	■	2	529017	HAPG-57
	12, 16	10	■	■		529018	HAPG-58
	12, 16	12	■	■		191266	HAPG-48
	20, 25	12	■	■		191267	HAPG-49
	20, 25	16	■	■		191269	HAPG-51
	20, 25	20	■	■		191270	HAPG-52
	DRRD	HGPP			DHAA		
	16	10	■	■	2	2157955	DHAA-G-Q11-16-B5-10
	16	12	■	■		2154048	DHAA-G-Q11-16-B5-12
	20	10	■	■		2158267	DHAA-G-Q11-20-B5-10
	20	12	■	■		2152457	DHAA-G-Q11-20-B5-12
	20	16	■	■		2152074	DHAA-G-Q11-20-B5-16
	25	16	■	■		1722274	DHAA-G-Q11-25-B5-16
	25	20	■	■		1722461	DHAA-G-Q11-25-B5-20
	32	20	■	■		2177999	DHAA-G-Q11-32-B5-20
	32	25	■	■		2180764	DHAA-G-Q11-32-B5-25
	35	25	■	■		2180954	DHAA-G-Q11-35-B5-25
	35, 40	32	■	■		2181855	DHAA-G-Q11-3 5/40-B5-32

1) More information: www.festo.com/x/topic/crc

Accessories



Adapter kit
HAPG

Material:
Wrought aluminium alloy
RoHS-compliant

 **Note**
The kit includes the individual mounting interface as well as the necessary mounting material.

Permissible drive/gripper combinations with adapter kit

Download CAD data → www.festo.com

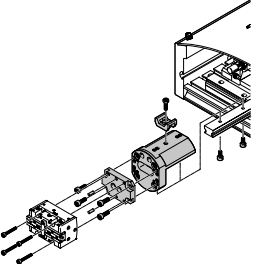
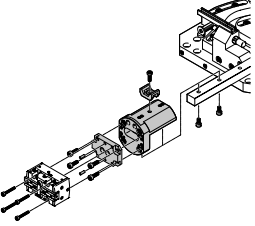
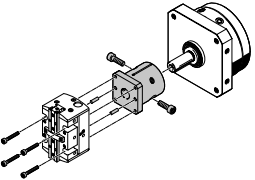
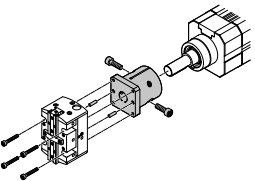
Combination	Drive Size	Gripper Size	Mounting option		Adapter kit		
					CRC ¹⁾	Part no.	Type
	HSP	10	■	–	2	529017	HAPG-57
			■	–		540882	HAPG-71-B
	25	10	■	–		529017	HAPG-57
			■	–		540883	HAPG-72-B
	16	12	■	–		191900	HAPG-54
			■	–		540882	HAPG-71-B
	25	12	■	–		191900	HAPG-54
			■	–		540883	HAPG-72-B
	25	16	■	–		191901	HAPG-55
			■	–		540883	HAPG-72-B
	HSW	10	■	–	2	529017	HAPG-57
			■	–		540882	HAPG-71-B
	16	12	■	–		191900	HAPG-54
			■	–		540882	HAPG-71-B
	16	16	■	–		191901	HAPG-55
			■	–		540882	HAPG-71-B
		DSM	12	■		■	2
■				■	191259	HAPG-41	
32		16	■	■	191260	HAPG-42	
			■	■	191261	HAPG-43	
40		20	■	■			
	DSL	12	■	■	2	191258	HAPG-40
			■	■		191259	HAPG-41
	32	16	■	■		191260	HAPG-42
			■	■		191261	HAPG-43
	40	20	■	■			

1) More information: www.festo.com/x/topic/crc



Accessories

Adapter kit
HAPG, HMSV

Material:
Wrought aluminium alloy
RoHS-compliant

 **Note**

The kit includes the individual mounting interface as well as the necessary mounting material.

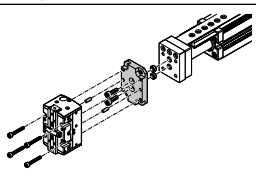
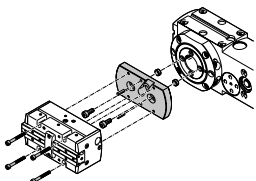
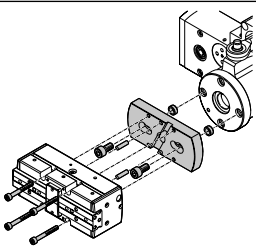
Permissible drive/gripper combinations with adapter kit					Download CAD data → www.festo.com		
Combination	Drive Size	Gripper Size	Mounting option		Adapter kit CRC ¹⁾	Part no.	Type
							
EGSL/HGPP	EGSL	HGPP			HAPG, HMSV		
	35	10	■	■	2	1088262	HMSV-70
	45, 55	10	■	■		529017	HAPG-57
	45, 55	12	■	■		529018	HAPG-58
	75	12	■	■		191266	HAPG-48
	75	16	■	■		191267	HAPG-49
						191269	HAPG-51
ERMB/HGPP	ERMB	HGPP			HAPG		
	20	10	■	■	2	526023	HAPG-SD2-17
	20	12	■	■		191255	HAPG-SD2-14
	20, 25	16	■	■		191256	HAPG-SD2-15
	25, 32	20	■	■		191257	HAPG-SD2-16
	32	25	■	■		526024	HAPG-SD2-18
EHMB/HGPP	EHMB	HGPP			HAPG		
	20	20	■	■	2	191257	HAPG-SD2-16
	20, 25, 32	25	■	■		526024	HAPG-SD2-18
	25, 32	32	■	■		526025	HAPG-SD2-19

1) More information: www.festo.com/x/topic/crc

Adapter for heavy-duty parallel gripper HGPT-B

Accessories



Adapter kit
DHAA, HAPG

Material:
Wrought aluminium alloy
RoHS-compliant

 **Note**
The kit includes the individual mounting interface as well as the necessary mounting material.

Permissible drive/gripper combinations with adapter kit

Download CAD data → www.festo.com

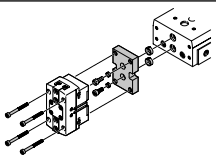
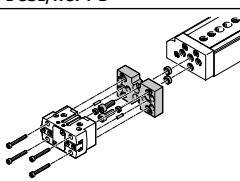
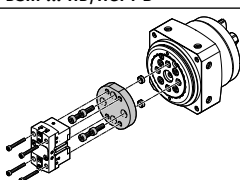
Combination	Drive Size	Gripper Size	Mounting option		Adapter kit			
					CRC ¹⁾	Part no.	Type	
	DGST	HGPT-B			DHAA			
	10	16	–	■	2	8163575	DHAA-G-G8-10-B8-16	
	12	20	–	■		8163574	DHAA-G-G8-12-B8-20	
	16	25	–	■		8163577	DHAA-G-G8-16-B8-25	
	20	35	–	■		8163576	DHAA-G-G8-20-B8-35	
	25	40	–	■		8163573	DHAA-G-G8-25-B8-40	
		DGST	HGPT-B-...-G1/G2			DHAA		
	10	16	–	■	2	8163580	DHAA-G-G8-10-B8G-16	
	12	20	–	■		8163582	DHAA-G-G8-12-B8G-20	
	16	25	–	■		8163579	DHAA-G-G8-16-B8G-25	
	20	35	–	■		8163581	DHAA-G-G8-20-B8G-35	
	25	40	–	■		8163578	DHAA-G-G8-25-B8G-40	
		DGSL	HGPT-B			DHAA, HAPG		
		8, 10	16, 20	■	■	2	564957	DHAA-G-G6-8-B8-16
12, 16		16, 20	■	■	564954		DHAA-G-G6-16-B8-16	
12, 16		25	■	■	564952		DHAA-G-G6-16-B8-25	
20, 25		25, 35	■	■	537175		HAPG-79	
20, 25		40	■	■	564951		DHAA-G-G6-20-B8-40	
	DSM-...-HD	HGPT-B			DHAA			
	12	16	■	■	2	8079169	DHAA-G-R3-12-B8-16	
	12	20	■	■		8079170	DHAA-G-R3-12-B8-20	
	16	16	■	■		8079193	DHAA-G-R3-16-B8-16	
	16	20	■	■		8079195	DHAA-G-R3-16-B8-20	
	25	16	■	■		8079202	DHAA-G-R3-25-B8-16	
	25	20	■	■		8079205	DHAA-G-R3-25-B8-20	
	25	25	■	■		8079207	DHAA-G-R3-25-B8-25	
	32	20	■	■		8079217	DHAA-G-R3-32-B8-20	
	32	25	■	■		8079218	DHAA-G-R3-32-B8-25	
	32	35	■	■		8079221	DHAA-G-R3-32-B8-35	

1) More information: www.festo.com/x/topic/crc



Accessories

Adapter kit
DHAA

Material:
Wrought aluminium alloy
RoHS-compliant

 **Note**
The kit includes the individual mounting interface as well as the necessary mounting material.

Download CAD data → www.festo.com

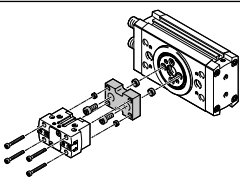
Permissible drive/gripper combinations with adapter kit					Download CAD data → www.festo.com		
Combination	Drive Size	Gripper Size	Mounting option		CRC ¹⁾	Part no.	Type
							
	DRRD	HGPT-B			DHAA		
	12	16	■	■	2	2449927	DHAA-G-Q11-12-B8/B8G-16
	12	20	■	■		2449921	DHAA-G-Q11-12-B8-20
	16	16	■	■		2091740	DHAA-G-Q11-16-B8/B8G-16
	16	20	■	■		2091577	DHAA-G-Q11-16-B8-20
	16	25	■	■		2090543	DHAA-G-Q11-16-B8-25
	20	25	■	■		2088114	DHAA-G-Q11-20-B8-25
	20	35	■	■		2087524	DHAA-G-Q11-20-B8-35
	25	35	■	■		1731604	DHAA-G-Q11-25-B8-35
	25	40	■	■		1731735	DHAA-G-Q11-25-B8-40
	32	40	■	■		2092070	DHAA-G-Q11-32-B8-40
	35	40	■	■		2114241	DHAA-G-Q11-35-B8-40
	32	50	■	■		2118750	DHAA-G-Q11-32-B8-50
	35, 40	50	■	■		2124990	DHAA-G-Q11-3 5/40-B8-50
	40	63	■	■		2125264	DHAA-G-Q11-40-B8-63
	50	63	■	■		2424526	DHAA-G-Q11-50-B8-63
	50	80	■	■		2424527	DHAA-G-Q11-50-B8-80
	DRRD	HGPT-B-G			DHAA		
	12	16	■	■	2	2449927	DHAA-G-Q11-12-B8/B8G-16
	12	20	■	■		2800827	DHAA-G-Q11-12-B8G-20
	16	16	■	■		2091740	DHAA-G-Q11-16-B8/B8G-16
	16	20	■	■		2595935	DHAA-G-Q11-16-B8G-20
	16	25	■	■		2596187	DHAA-G-Q11-16-B8G-25
	20	25	■	■		2596248	DHAA-G-Q11-20-B8G-25
	20	35	■	■		2596517	DHAA-G-Q11-20-B8G-35
	25	35	■	■		2597040	DHAA-G-Q11-25-B8G-35
	25	40	■	■		2597322	DHAA-G-Q11-25-B8G-40
	32	40	■	■		2597387	DHAA-G-Q11-32-B8G-40
	35	40	■	■		2597928	DHAA-G-Q11-35-B8G-40
	32	50	■	■		2597428	DHAA-G-Q11-32-B8G-50
	35, 40	50	■	■		2604977	DHAA-G-Q11-3 5/40-B8G-50
	40	63	■	■		2604813	DHAA-G-Q11-40-B8G-63
	50	63	■	■		2604845	DHAA-G-Q11-50-B8G-63
	50	80	■	■		2604887	DHAA-G-Q11-50-B8G-80

1) More information: www.festo.com/x/topic/crc

Adapter for heavy-duty parallel gripper HGPT-B

Accessories



Adapter kit
DHAA, HAPG

Material:
Wrought aluminium alloy
RoHS-compliant

 **Note**
The kit includes the individual mounting interface as well as the necessary mounting material.

Permissible drive/gripper combinations with adapter kit

Download CAD data → www.festo.com

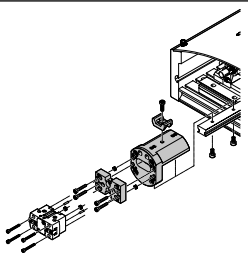
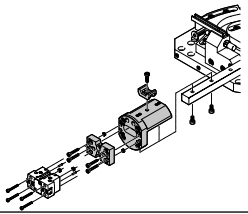
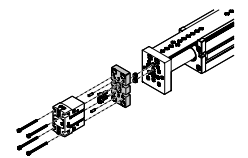
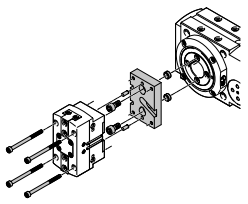
Combination	Drive Size	Gripper Size	Mounting option		Adapter kit		
					CRC ¹⁾	Part no.	Type
	HSP	HGPT-B			DHAA, HAPG		
	12	16	■	–	2	564957	DHAA-G-G6-8-B8-16
						540881	HAPG-70-B
	16	16, 20	■	–		564957	DHAA-G-G6-8-B8-16
						540882	HAPG-71-B
25	16, 20	■	–	564957		DHAA-G-G6-8-B8-16	
					540883	HAPG-72-B	
	HSW	HGPT-B			DHAA, HAPG		
	12	16	■	–	2	564957	DHAA-G-G6-8-B8-16
						540882	HAPG-71-B
	16	16, 20	■	–		564957	DHAA-G-G6-8-B8-16
				540882		HAPG-71-B	
	EGSL	HGPT-B			DHAA, HAPG		
	45, 55	25	■	■	2	564952	DHAA-G-G6-16-B8-25
	75	40	■	■		564951	DHAA-G-G6-20-B8-40
	75	25, 35	■	■		537175	HAPG-79
	ERMB	HGPT-B			DHAA, HAPG		
	20	25	■	■	2	537181	HAPG-SD2-25
	20, 25	35	■	■		537173	HAPG-SD2-23
	25, 32	40	■	■		537184	HAPG-SD2-26
						564956	DHAA-G-Q5-32-B8-50
32	50	■	■				

1) More information: www.festo.com/x/topic/crc



Accessories

Adapter kit
DHAA, HAPG

Material:
Wrought aluminium alloy
RoHS-compliant

 **Note**
The kit includes the individual mounting interface as well as the necessary mounting material.

Download CAD data → www.festo.com

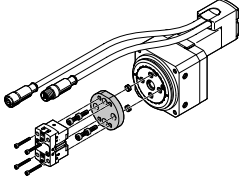
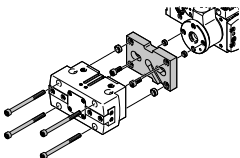
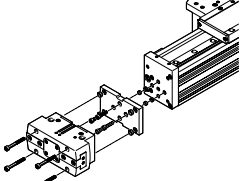
Permissible drive/gripper combinations with adapter kit							
Combination	Drive Size	Gripper Size	Mounting option		Adapter kit		
					CRC ¹⁾	Part no.	Type
	ERMO	HGPT-B			DHAA		
	12	16	■	■	2	8079169	DHAA-G-R3-12-B8-16
	12	20	■	■		8079170	DHAA-G-R3-12-B8-20
	16	16	■	■		8079193	DHAA-G-R3-16-B8-16
	16	20	■	■		8079195	DHAA-G-R3-16-B8-20
	25	16	■	■		8079202	DHAA-G-R3-25-B8-16
	25	20	■	■		8079205	DHAA-G-R3-25-B8-20
	25	25	■	■		8079207	DHAA-G-R3-25-B8-25
	32	20	■	■		8079217	DHAA-G-R3-32-B8-20
	32	25	■	■		8079218	DHAA-G-R3-32-B8-25
	32	35	■	■		8079221	DHAA-G-R3-32-B8-35
	EHMB	HGPT-B			DHAA, HAPG		
	20	40	■	■	2	537184	HAPG-SD2-26
	20, 25, 32	50	■	■		564956	DHAA-G-Q5-32-B8-50
	25, 32	63	■	■		537188	HAPG-SD2-28
	ELCC	HGPT-B			DHAA		
	60	35	■	■	2	5162493	DHAA-G-E21-60-B8-35
	60	40	■	■		5162495	DHAA-G-E21-60-B8-40
	60	50	■	■		5162497	DHAA-G-E21-60-B8-50
	70	40	■	■		2092070	DHAA-G-Q11-32-B8-40
	70, 90	50	■	■		2118750	DHAA-G-Q11-32-B8-50
	70, 90, 110	63	■	■		5162500	DHAA-G-E21-70...110-B8-63
	90, 110	80	■	■		5162502	DHAA-G-E21-70...110-B8-80
	ELCC	HGPT-B-G			DHAA		
	60	35	■	■	2	5162494	DHAA-G-E21-60-B8G-35
	60	40	■	■		5162496	DHAA-G-E21-60-B8G-40
	60	50	■	■		5162498	DHAA-G-E21-60-B8G-50
	70	40	■	■		2597387	DHAA-G-Q11-32-B8G-40
	70, 90	50	■	■		2597428	DHAA-G-Q11-32-B8G-50
	70, 90, 110	63	■	■		5162501	DHAA-G-E21-70...110-B8G-63
90, 110	80	■	■		5162503	DHAA-G-E21-70...110-B8G-80	

1) More information: www.festo.com/x/topic/crc

Adapter for three-point gripper DHDS

Accessories

Adapter kit
DHAA, HAPG, HMSV, HMVA

Material:
Wrought aluminium alloy
RoHS-compliant

 **Note**
The kit includes the individual mounting interface as well as the necessary mounting material.

Permissible drive/gripper combinations with adapter kit

Download CAD data → www.festo.com

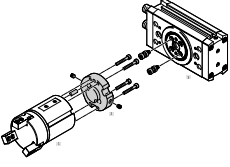
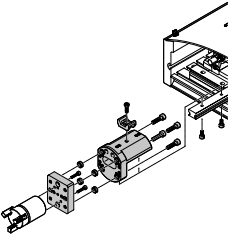
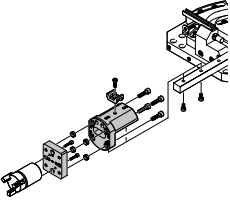
Combination	Drive Size	Gripper Size	Adapter kit		
			CRC ¹⁾	Part no.	Type
DRRD/DHDS	DRRD	DHDS	DHAA		
	12	16	2	2823512	DHAA-G-Q11-12-B4-16
	16	16		2136626	DHAA-G-Q11-16-B4-16
	16	32		2151381	DHAA-G-Q11-16-B4-32
	20	32		2136339	DHAA-G-Q11-20-B4-32
	25	32		1471583	DHAA-G-Q11-25-B4-32
	25	50		1731165	DHAA-G-Q11-25-B4-50
	32	50		1907040	DHAA-G-Q11-32-B4-50
	35	50		2135899	DHAA-G-Q11-35-B4-50
	HSP/DHDS	HSP		DHDS	HAPG
	16	16	2	192705	HAPG-36-S1
				540882	HAPG-71-B
	25	16		192705	HAPG-36-S1
				540883	HAPG-72-B
HSW/DHDS	HSW	DHDS	HAPG		
	16	16	2	192705	HAPG-36-S1
				540882	HAPG-71-B

1) More information: www.festo.com/x/topic/crc

2) For DGEA... only

Accessories

Adapter kit
DHAA, HAPG

Material:
Wrought aluminium alloy
RoHS-compliant

 **Note**

The kit includes the individual mounting interface as well as the necessary mounting material.

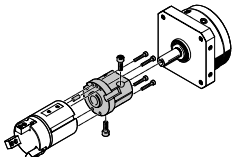
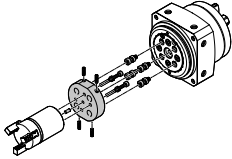
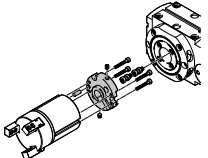
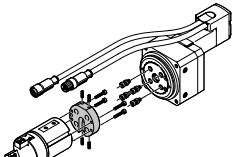
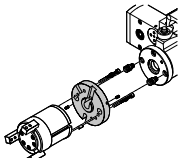
Permissible drive/gripper combinations with adapter kit				Download CAD data → www.festo.com		
Combination	Drive Size	Gripper Size	Adapter kit			
			CRC ¹⁾	Part no.	Type	
DSM/DHDS	DSM	DHDS	HAPG			
	8, 10	16	2	187569	HAPG-35	
	25	32		163272	HAPG-23	
DSM-...-HD/DHDS	DSM-...-HD	DHDS	DHAA			
	12	16	2	8072232	DHAA-G-R3-12-B19-16	
	16	16		8079175	DHAA-G-R3-16-B19-16	
	16	32		8079191	DHAA-G-R3-16-B19-32	
	25	32		8079196	DHAA-G-R3-25-B19-32	
	25	50		8079199	DHAA-G-R3-25-B19-50	
	32	50		8079210	DHAA-G-R3-32-B19-50	
ERMB/DHDS	ERMB	DHDS	HAPG			
	20	32	2	184481	HAPG-SD2-5	
	25	50		184484	HAPG-SD2-8	
	32	50		184487	HAPG-SD2-11	
ERMO/DHDS	ERMO	DHDS	DHAA			
	12	16	2	8072232	DHAA-G-R3-12-B19-16	
	16	16		8079175	DHAA-G-R3-16-B19-16	
	16	32		8079191	DHAA-G-R3-16-B19-32	
	25	32		8079196	DHAA-G-R3-25-B19-32	
	25	50		8079199	DHAA-G-R3-25-B19-50	
	32	50		8079210	DHAA-G-R3-32-B19-50	
EHMB/DHDS	EHMB	DHDS	HAPG			
	20	50	2	184487	HAPG-SD2-11	
	25, 32	50		526026	HAPG-SD2-20	

1) More information: www.festo.com/x/topic/crc

Adapter for three-point gripper HGDD, sealed

Accessories

Adapter kit
DHAA, HAPG

Material:
Wrought aluminium alloy
RoHS-compliant

 **Note**
The kit includes the individual mounting interface as well as the necessary mounting material.

Permissible drive/gripper combinations with adapter kit

Download CAD data → www.festo.com

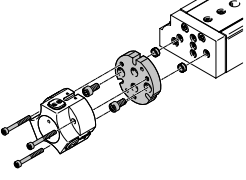
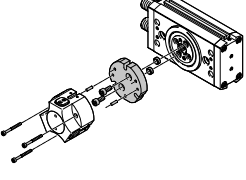
Combination	Drive Size	Gripper Size	Adapter kit		
			CRC ¹⁾	Part no.	Type
DGSL/HGDD	DGSL	HGDD	DHAA		
	16, 20, 25	35	2	2371422	DHAA-G-G3-20-B13-35
	20, 25	40		2373773	DHAA-G-H2-16-B13-40
	25	50		2377625	DHAA-G-H2-20-B13-50
	DGSL	HGDD-G1/G2	DHAA, HAPG		
	16, 20, 25	35	2	542436	HAPG-94
	20, 25	40		542437	HAPG-95
25	50	2378415		DHAA-G-H2-20-B13G-50	
DRRD/HGDD	DRRD	HGDD	DHAA		
	20	35	2	2075498	DHAA-G-Q11-20-B13-35
	25	35		1718041	DHAA-G-Q11-25-B13-35
	25	40		1718564	DHAA-G-Q11-25-B13-40
	32	40		2077119	DHAA-G-Q11-32-B13-40
	32	50		2078975	DHAA-G-Q11-32-B13-50
	35	50		2079171	DHAA-G-Q11-35-B13-50
	35, 40	63		2079579	DHAA-G-Q11-3 5/40-B13-63
	DRRD	HGDD-G1/G2		DHAA	
	20	35	2	2837144	DHAA-G-Q11-20-B13G-35
	25	35		2837169	DHAA-G-Q11-25-B13G-35
	25	40		2837182	DHAA-G-Q11-25-B13G-40
	32	40		2837254	DHAA-G-Q11-32-B13G-40
	32	50		2837269	DHAA-G-Q11-32-B13G-50
	35	50		2837283	DHAA-G-Q11-35-B13G-50
35, 40	63	2837337		DHAA-G-Q11-3 5/40-B13G-63	

1) More information: www.festo.com/x/topic/crc

Accessories

Adapter kit
DHAA/HAPG

Material:
Wrought aluminium alloy
RoHS-compliant

 **Note**

The kit includes the individual mounting interface as well as the necessary mounting material.

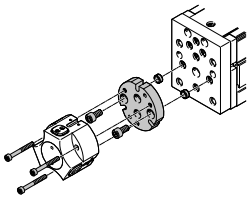
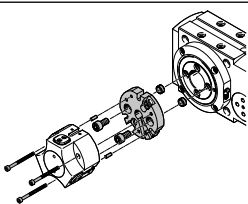
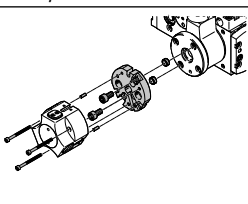
Permissible drive/gripper combinations with adapter kit				Download CAD data → www.festo.com		
Combination	Drive Size	Gripper Size	Adapter kit			
			CRC ¹⁾	Part no.	Type	
	EGSL	HGDD	DHAA			
	45, 55, 75	35	2	2371422	DHAA-G-G3-20-B13-35	
	75	40		2373773	DHAA-G-H2-16-B13-40	
	75	50		2377625	DHAA-G-H2-20-B13-50	
	EGSL	HGDD-G1/G2	DHAA, HAPG			
	45, 55, 75	35	2	542436	HAPG-94	
	75	40		542437	HAPG-95	
	75	50		2378415	DHAA-G-H2-20-B13G-50	
		ERMB	HGDD	DHAA		
20, 25, 32		35	2	2376297	DHAA-G-Q5-20-B13-35	
25, 32		40		2376728	DHAA-G-Q5-25-B13-40	
32		50		2377625	DHAA-G-H2-20-B13-50	
ERMB		HGDD-G1/G2	DHAA, HAPG			
20, 25, 32		35	2	542441	HAPG-SD2-34	
25, 32		40		542442	HAPG-SD2-35	
32		50		2378415	DHAA-G-H2-20-B13G-50	
		EHMB	HGDD	DHAA		
	20	35	2	2376297	DHAA-G-Q5-20-B13-35	
	20	40		2376728	DHAA-G-Q5-25-B13-40	
	20	50		2377625	DHAA-G-H2-20-B13-50	
	EHMB	HGDD-G1/G2	DHAA, HAPG			
	20	35	2	542441	HAPG-SD2-34	
	20	40		542442	HAPG-SD2-35	
	20	50		2378415	DHAA-G-H2-20-B13G-50	

1) More information: www.festo.com/x/topic/crc

Adapter for heavy-duty three-point gripper HGDT

Accessories

Adapter kit
HAPG

Material:
Wrought aluminium alloy
RoHS-compliant

 **Note**
The kit includes the individual mounting interface as well as the necessary mounting material.

Permissible drive/gripper combinations with adapter kit

Download CAD data → www.festo.com

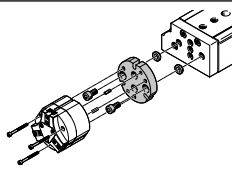
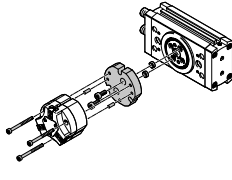
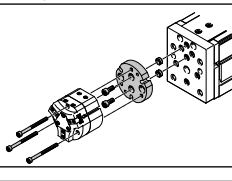
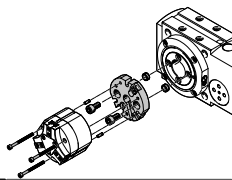
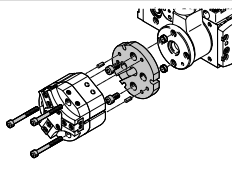
Combination	Drive Size	Gripper Size	Adapter kit CRC ¹⁾	Part no.	Type	
DGSL/HGDT	DGSL	HGDT	HAPG			
	16	25	2	542439	HAPG-SD2-32	
	16	35		542436	HAPG-94	
	20, 25	35		548805	ZBV-9-7	
	20, 25	40		542436	HAPG-94	
	20, 25	40		542437	HAPG-95	
	25	50		542443	HAPG-SD2-36	
				548806	ZBV-12-9	
DRRD/HGDT	DRRD	HGDT	DHAA			
	16	25	2	2079812	DHAA-G-Q11-16-B7/B7G-25	
	20	25		2079695	DHAA-G-Q11-20-B7/B7G-25	
	20	35		2077056	DHAA-G-Q11-20-B7-35	
	25	35		1735057	DHAA-G-Q11-25-B7-35	
	25	40		1735103	DHAA-G-Q11-25-B7-40	
	32	40		2077253	DHAA-G-Q11-32-B7-40	
	32	50		2077335	DHAA-G-Q11-32-B7-50	
	35	50		2079063	DHAA-G-Q11-35-B7-50	
	35, 40	63		2079274	DHAA-G-Q11-3 5/40-B7-63	
		DRRD	HGDT-G	DHAA		
		20	35	2	2832455	DHAA-G-Q11-20-B7G-35
		25	35		2832483	DHAA-G-Q11-25-B7G-35
		25	40		2832545	DHAA-G-Q11-25-B7G-40
		32	40		2832575	DHAA-G-Q11-32-B7G-40
		32	50		2832600	DHAA-G-Q11-32-B7G-50
		35	50		2832617	DHAA-G-Q11-35-B7G-50
	35, 40	63	2832631		DHAA-G-Q11-3 5/40-B7G-63	
EGSL/HGDT	EGSL	HGDT	HAPG			
	35	25	2	542433	HAPG-97	
	45, 55	25		542439	HAPG-SD2-32	
	45, 55, 75	35		542436	HAPG-94	
	75	40		542437	HAPG-95	
	75	50		542443	HAPG-SD2-36	
ERMB/HGDT	ERMB	HGDT	HAPG			
	20, 25	25	2	542440	HAPG-SD2-33	
	20, 25, 32	35		542441	HAPG-SD2-34	
	25, 32	40		542442	HAPG-SD2-35	
	32	50		542443	HAPG-SD2-36	
EHMB/HGDT	EHMB	HGDT	HAPG			
	20	35	2	542441	HAPG-SD2-34	
	20	40		542442	HAPG-SD2-35	
	20	50		542443	HAPG-SD2-36	

1) More information: www.festo.com/x/topic/crc



Accessories

Adapter kit
HMSV, HAPG, DHAA

Material:
Wrought aluminium alloy
RoHS-compliant

 **Note**

The kit includes the individual mounting interface as well as the necessary mounting material.

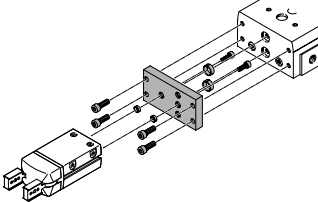
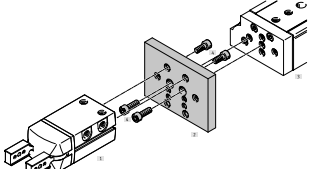
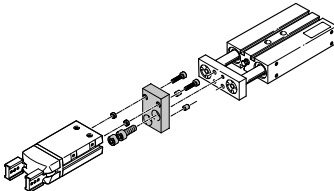
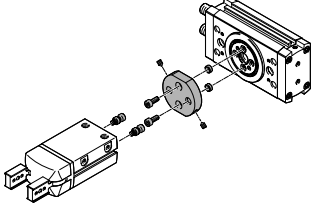
Permissible drive/gripper combinations with adapter kit							Download CAD data → www.festo.com	
Combination	Drive Size	Gripper		Adapter kit		Type		
		Size	Mounting option	CRC ¹⁾	Part no.			
								
DGST/DHRS	DGST	DHRS			DHAA			
	10	10	■	■	2	8161907	DHAA-G-G8-10-B20-10	
	12	16	■	■		8161909	DHAA-G-G8-12-B20-16	
	16	16	■	■		8161908	DHAA-G-G8-16-B20-16	
	20	25	■	■		8161905	DHAA-G-G8-20-B20-25	
	25	32	■	■		8161906	DHAA-G-G8-25-B20-32	
DGSL/DHRS	DGSL	DHRS			HMSV			
	8, 10	10	■	■	2	548784	HMSV-54	
	12, 16	16	■	■		548785	HMSV-55	
	20, 25	25, 32	■	■		548786	HMSV-56	
DPZ/DHRS	DPZ	DHRS			HAPG			
	10, 16	16	■	–	2	163250	HAPG-1	
	16	25	■	–		163251	HAPG-2	
	20	25	■	–		163252	HAPG-3	
	25, 32	32	■	–		163253	HAPG-4	
DRRD/DHRS	DRRD	DHRS			DHAA			
	8	10	■	■	2	2816591	DHAA-G-Q11-8-B2/B3-10	
	10	10	■	■		2816068	DHAA-G-Q11-10-B2/B3-10	
	12	10	■	■		2814790	DHAA-G-Q11-12-B2/B3-10	
	12	16	■	■		2811183	DHAA-G-Q11-12-B2/B3-16	
	16	16	■	■		1979085	DHAA-G-Q11-16-B2/B3-16	
	16	25	■	■		1978889	DHAA-G-Q11-16-B2/B3-25	
	20	25	■	■		1978443	DHAA-G-Q11-20-B2/B3-25	
	20	32	■	■		1979912	DHAA-G-Q11-20-B2/B3-32	
	25	25	■	■		1801802	DHAA-G-Q11-25-B2/B3-25	
	25	32	■	■		1802969	DHAA-G-Q11-25-B2/B3-32	
	32	32	■	■		1979992	DHAA-G-Q11-32-B2/B3-32	
	32	40	■	■		1980014	DHAA-G-Q11-32-B2/B3-40	
	35, 40	40	■	■		1980059	DHAA-G-Q11-3 5/40-B2/B3-40	

1) More information: www.festo.com/x/topic/crc

Adapter for radial gripper DHRS

Accessories



Adapter kit
HAPG, DHAA

Material:
Wrought aluminium alloy
RoHS-compliant

 **Note**
The kit includes the individual mounting interface as well as the necessary mounting material.

Permissible drive/gripper combinations with adapter kit

Download CAD data → www.festo.com

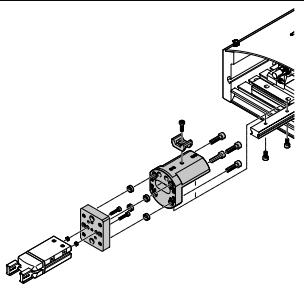
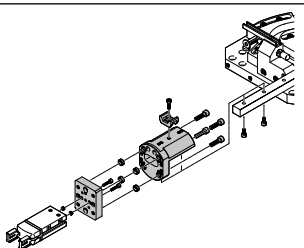
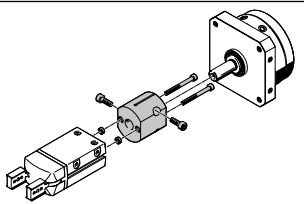
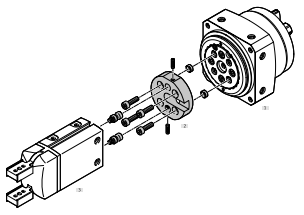
Combination	Drive Size	Gripper		Adapter kit		Type		
		Size	Mounting option		CRC ¹⁾		Part no.	
								
HSP/DHRS	HSP	DHRS			HAPG			
	12	10	■	–	2	192709	HAPG-60-S1	
						540881	HAPG-70-B	
	16	10	■	–		192706	HAPG-37-S1	
						540882	HAPG-71-B	
	16	16	■	–		192705	HAPG-36-S1	
						540882	HAPG-71-B	
	25	16	■	–		192705	HAPG-36-S1	
				540883	HAPG-72-B			
	25	25	■	–	193922	HAPG-37-S4		
					540883	HAPG-72-B		
HSW/DHRS	HSW	DHRS			HAPG			
	12, 16	10	■	–	2	192706	HAPG-37-S1	
						540882	HAPG-71-B	
	12, 16	16	■	–		192705	HAPG-36-S1	
						540882	HAPG-71-B	
DSM/DHRS	DSM-...-FW	DHRS			HAPG			
	6, 8, 10	10	■	■	2	187568	HAPG-34	
	DSM-...	DHRS				HAPG		
	12	16	■	■		2	163266	HAPG-17
	16	16	■	■			163267	HAPG-18
	16	25	■	■			163268	HAPG-19
	25	25	■	■			163269	HAPG-20
	25	32	■	■			163270	HAPG-21
	32	32	■	■			163271	HAPG-22
DSM-...-HD/DHRS	DSM-...-HD	DHRS			DHAA			
	12	16	■	■	2	8072157	DHAA-G-R3-12-B18-10	
	12	10	■	■		8072172	DHAA-G-R3-12-B20-10	
	16	16	■	■		8071917	DHAA-G-R3-16-B18-10	
	16	25	■	■		8079173	DHAA-G-R3-16-B18-16	
	25	25	■	■		8071956	DHAA-G-R3-25-B18-16	
	25	32	■	■		8079201	DHAA-G-R3-25-B20-32	
	32	32	■	■		8079208	DHAA-G-R3-32-B18-25	
	32	40	■	■		8079212	DHAA-G-R3-32-B20-40	

1) More information: www.festo.com/x/topic/crc



Accessories

Adapter kit
HAPG, HMSV, DHAA

Material:
Wrought aluminium alloy
RoHS-compliant

 **Note**

The kit includes the individual mounting interface as well as the necessary mounting material.

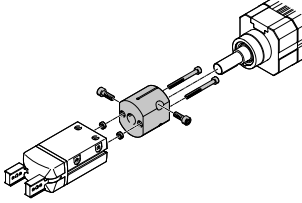
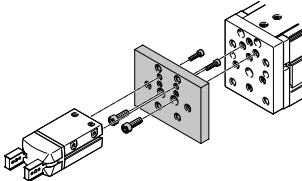
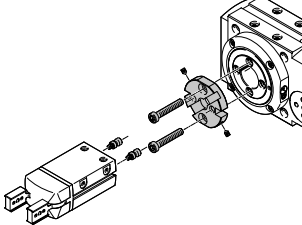
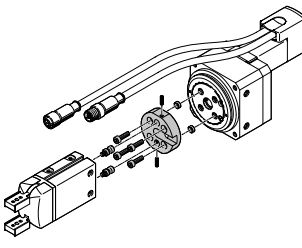
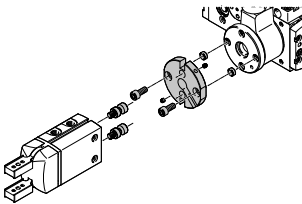
Permissible drive/gripper combinations with adapter kit							Download CAD data → www.festo.com	
Combination	Drive Size	Gripper		Adapter kit CRC ¹⁾	Part no.	Type		
		Size	Mounting option					
								
DSL/DHRS	DSL	DHRS			HAPG			
	16	16	■	■	2	163266	HAPG-17	
	20	16	■	■		163267	HAPG-18	
	20	25	■	■		163268	HAPG-19	
	25	25	■	■		163269	HAPG-20	
	25	32	■	■		163270	HAPG-21	
	32	32	■	■		163271	HAPG-22	
EGSL/DHRS	EGSL	DHRS			HMSV			
	35	10	■	■	2	548784	HMSV-54	
	45, 55	16	■	■		1088262	HMSV-70	
	75	25, 32	■	■		548785	HMSV-55	
						548786	HMSV-56	
ERMB/DHRS	ERMB	DHRS			HAPG			
	20	25	■	■	2	184479	HAPG-SD2-3	
	25	25	■	■		184482	HAPG-SD2-6	
	20	32	■	■		184480	HAPG-SD2-4	
	25	32	■	■		184483	HAPG-SD2-7	
	32	32	■	■		184485	HAPG-SD2-9	
	32	40	■	■		184486	HAPG-SD2-10	
ERMO/DHRS	ERMO	DHRS			DHAA			
	12	16	■	■	2	8072157	DHAA-G-R3-12-B18-10	
	12	10	■	■		8072172	DHAA-G-R3-12-B20-10	
	16	16	■	■		8071917	DHAA-G-R3-16-B18-10	
	16	25	■	■		8079173	DHAA-G-R3-16-B18-16	
	25	25	■	■		8071956	DHAA-G-R3-25-B18-16	
	25	32	■	■		8079201	DHAA-G-R3-25-B20-32	
	32	32	■	■		8079208	DHAA-G-R3-32-B18-25	
	32	40	■	■		8079212	DHAA-G-R3-32-B20-40	
EHMB/DHRS	EHMB	DHRS			HAPG			
	20	32	■	■	2	184485	HAPG-SD2-9	
	20	40	■	■		184486	HAPG-SD2-10	
	25, 32	40	■	■		526027	HAPG-SD2-21	

1) More information: www.festo.com/x/topic/crc

Adapter for heavy-duty radial gripper HGRT

Accessories

Adapter kit
DHAA

Material:
Wrought aluminium alloy
RoHS-compliant





Note

The kit includes the individual mounting interface as well as the necessary mounting material.

Permissible drive/gripper combinations with adapter kit

Download CAD data → www.festo.com

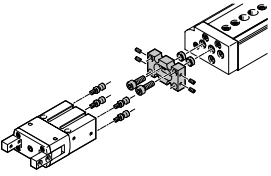
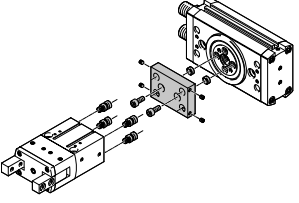
Combination	Drive Size	Gripper Size	Mounting option		Adapter kit CRC ¹⁾	Part no.	Type
							
DGSL/HGRT	DGSL	HGRT			DHAA		
	8, 10	16	■	■	2	1273902	DHAA-G-G6-8-B11-16
	12, 16	16	■	■		1467524	DHAA-G-G6-12-B11-16
	12, 16	20	■	■		1278364	DHAA-G-G6-12-B11-20
	20, 25	25	■	■		1468307	DHAA-G-G6-20-B11-25
	25	32	■	■		1280494	DHAA-G-G6-25-B11-32
DRRD/HGRT	DRRD	HGRT			DHAA		
	16	16	■	■	2	2185606	DHAA-G-Q11-16-B11-16
	20	20	■	■		2184467	DHAA-G-Q11-20-B11-20
	25	25	■	■		1741183	DHAA-G-Q11-25-B11-25
	25	32	■	■		1743177	DHAA-G-Q11-25-B11-32
	32	25	■	■		2184080	DHAA-G-Q11-32-B11-25
	32	32	■	■		2184322	DHAA-G-Q11-32-B11-32
	32	40	■	■		2184652	DHAA-G-Q11-32-B11-40
	35	40	■	■		2185436	DHAA-G-Q11-35-B11-40

1) More information: www.festo.com/x/topic/crc



Accessories

Adapter kit
DHAA, HAPG

Material:
Wrought aluminium alloy
RoHS-compliant

 **Note**

The kit includes the individual mounting interface as well as the necessary mounting material.

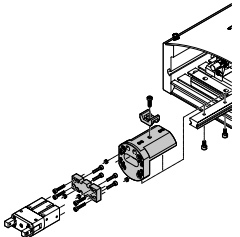
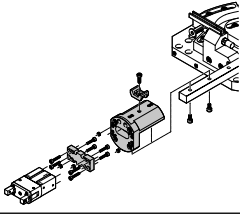
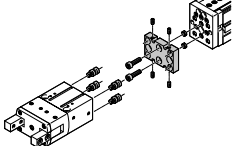
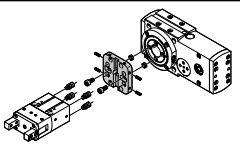
Permissible drive/gripper combinations with adapter kit							Download CAD data → www.festo.com		
Combination	Drive Size	Gripper Size	Mounting option		Adapter kit CRC ¹⁾	Part no.	Type		
									
	HSP	HGRT	■	–	DHAA, HAPG	2	1274347	DHAA-G-H4-16-B11-16	
							540882	HAPG-71-B	
	25	16	■	–			1274347	DHAA-G-H4-16-B11-16	
							540883	HAPG-72-B	
	HSW	HGRT	■	–	DHAA, HAPG	2	1274347	DHAA-G-H4-16-B11-16	
							540882	HAPG-71-B	
	12, 16	16							
	EGSL	HGRT	■	■	DHAA	2	1278364	DHAA-G-G6-12-B11-20	
							1279418	DHAA-G-E8-45-B11-25	
		20	25	■			■	1468307	DHAA-G-G6-20-B11-25
		45, 55	25	■			■	1280494	DHAA-G-G6-25-B11-32
		75	32	■			■		
	ERMB	HGRT	■	■	DHAA	2	1465263	DHAA-G-Q5-20-B11-20	
							1279439	DHAA-G-Q5-25-B11-25	
		20	25	■			■	1468949	DHAA-G-Q5-25-B11-32
		25, 32	32	■			■		

1) More information: www.festo.com/x/topic/crc

Accessories



Adapter kit
HAPG, HAPS, HMSV

Material:
Wrought aluminium alloy
RoHS-compliant

 **Note**
The kit includes the individual mounting interface as well as the necessary mounting material.

Permissible drive/gripper combinations with adapter kit

Download CAD data → www.festo.com

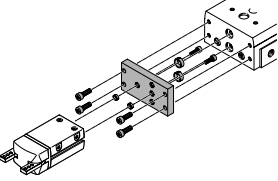
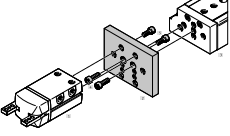
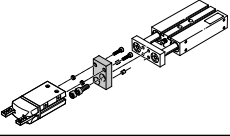
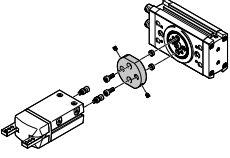
Combination	Drive Size	Gripper Size	Mounting option		Adapter kit		
					CRC ¹⁾	Part no.	Type
	DGST	DHWS			2	8161907	DHAA-G-G8-10-B20-10
	10	10	■	■			
	12	16	■	■			
	16	16	■	■			
	20	25	■	■			
	25	32	■	■	8161905	DHAA-G-G8-20-B20-25	
					8161906	DHAA-G-G8-25-B20-32	
	DGSL	DHWS			2	548784	HMSV-54
	8, 10	10	■	■			
	12, 16	16	■	■			
	20, 25	25, 32	■	■			
	DPZ	DHWS			2	163250	HAPG-1
	10, 16	16	■	–			
	16	25	■	–			
	20	25	■	–			
	25, 32	32	■	–			
	DRRD	DHWS			2	2816591	DHAA-G-Q11-8-B2/B3-10
	8	10	■	■			
	10	10	■	■			
	12	10	■	■			
	12	16	■	■			
	16	16	■	■			
	16	25	■	■			
	20	25	■	■			
	20	32	■	■			
	25	25	■	■			
	25	32	■	■			
	32	32	■	■			
	32	40	■	■			
	35, 40	40	■	■			
					2814790	DHAA-G-Q11-12-B2/B3-10	
					2811183	DHAA-G-Q11-12-B2/B3-16	
					1979085	DHAA-G-Q11-16-B2/B3-16	
					1978889	DHAA-G-Q11-16-B2/B3-25	
					1978443	DHAA-G-Q11-20-B2/B3-25	
					1979912	DHAA-G-Q11-20-B2/B3-32	
					1801802	DHAA-G-Q11-25-B2/B3-25	
					1802969	DHAA-G-Q11-25-B2/B3-32	
					1979992	DHAA-G-Q11-32-B2/B3-32	
					1980014	DHAA-G-Q11-32-B2/B3-40	
					1980059	DHAA-G-Q11-3 5/40-B2/B3-40	

1) More information: www.festo.com/x/topic/crc



Accessories

Adapter kit
DHAA, HAPG

Material:
Wrought aluminium alloy
RoHS-compliant

 **Note**

The kit includes the individual mounting interface as well as the necessary mounting material.

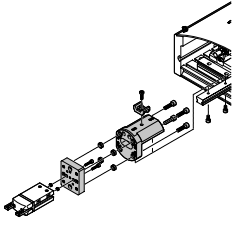
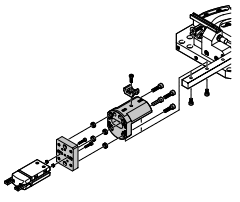
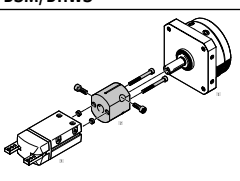
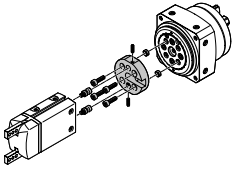
Permissible drive/gripper combinations with adapter kit							Download CAD data → www.festo.com	
Combination	Drive Size	Gripper Size	Mounting option		Adapter kit CRC ¹⁾	Part no.	Type	
								
	HSP	DHWS			HAPG			
	12	10	■	–	2	192709	HAPG-60-S1	
						540881	HAPG-70-B	
	16	10	■	–		192706	HAPG-37-S1	
						540882	HAPG-71-B	
	16	16	■	–		192705	HAPG-36-S1	
					540882	HAPG-71-B		
	25	16	■	–		192705	HAPG-36-S1	
						540883	HAPG-72-B	
	25	25	■	–		193922	HAPG-37-S4	
						540883	HAPG-72-B	
	HSW	DHWS			HAPG			
	12, 16	10	■	–	2	192706	HAPG-37-S1	
						540882	HAPG-71-B	
	12, 16	16	■	–		192705	HAPG-36-S1	
						540882	HAPG-71-B	
	DSM-...-FW	DHWS			HAPG			
	6, 8, 10	10	■	■	2	187568	HAPG-34	
	DSM-...	DHWS			HAPG			
	12	16	■	■	2	163266	HAPG-17	
	16	16	■	■		163267	HAPG-18	
	16	25	■	■		163268	HAPG-19	
	25	25	■	■		163269	HAPG-20	
	25	32	■	■		163270	HAPG-21	
32	32	■	■		163271	HAPG-22		
	DSM-...-HD	DHWS			DHAA			
	12	16	■	■	2	8072157	DHAA-G-R3-12-B18-10	
	12	10	■	■		8072172	DHAA-G-R3-12-B20-10	
	16	16	■	■		8071917	DHAA-G-R3-16-B18-10	
	16	25	■	■		8079173	DHAA-G-R3-16-B18-16	
	25	25	■	■		8071956	DHAA-G-R3-25-B18-16	
	25	32	■	■		8079201	DHAA-G-R3-25-B20-32	
	32	32	■	■		8079208	DHAA-G-R3-32-B18-25	
	32	40	■	■		8079212	DHAA-G-R3-32-B20-40	

1) More information: www.festo.com/x/topic/crc

Adapter for angle gripper DHWS

Accessories

Adapter kit
DHAA, HAPG, HMSV

Material:
Wrought aluminium alloy
RoHS-compliant





Note

The kit includes the individual mounting interface as well as the necessary mounting material.

Permissible drive/gripper combinations with adapter kit

Download CAD data → www.festo.com

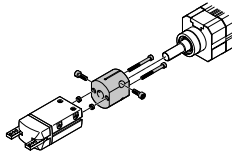
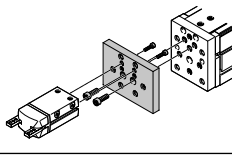
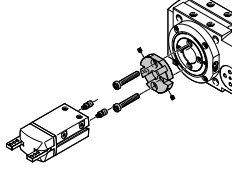
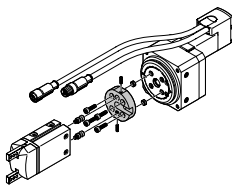
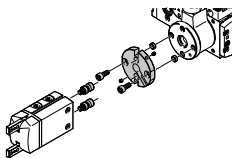
Combination	Drive Size	Gripper Size	Mounting option		Adapter kit CRC ¹⁾	Part no.	Type
							
	DSL	DHWS			HAPG 2	163266	HAPG-17
	16	16	■	■		163267	HAPG-18
	20	16	■	■		163268	HAPG-19
	20	25	■	■		163269	HAPG-20
	25	25	■	■		163270	HAPG-21
	25	32	■	■		163271	HAPG-22
	EGSL	DHWS			HMSV 2	548784	HMSV-54
	35	10	■	■		1088262	HMSV-70
	45, 55	16	■	■		548785	HMSV-55
	75	25, 32	■	■		548786	HMSV-56
	ERMB	DHWS			HAPG 2	184479	HAPG-SD2-3
	20	25	■	■		184482	HAPG-SD2-6
	25	25	■	■		184480	HAPG-SD2-4
	20	32	■	■		184483	HAPG-SD2-7
	25	32	■	■		184485	HAPG-SD2-9
	32	32	■	■		184486	HAPG-SD2-10
	32	40	■	■			
	ERMO	DHWS			DHAA 2	8072157	DHAA-G-R3-12-B18-10
	12	16	■	■		8072172	DHAA-G-R3-12-B20-10
	12	10	■	■		8071917	DHAA-G-R3-16-B18-10
	16	16	■	■		8079173	DHAA-G-R3-16-B18-16
	16	25	■	■		8071956	DHAA-G-R3-25-B18-16
	25	25	■	■		8079201	DHAA-G-R3-25-B20-32
	25	32	■	■		8079208	DHAA-G-R3-32-B18-25
	32	32	■	■		8079212	DHAA-G-R3-32-B20-40
	32	40	■	■			
	EHMB	DHWS			HAPG 2	184485	HAPG-SD2-9
	20	32	■	■		184486	HAPG-SD2-10
	20	40	■	■		526027	HAPG-SD2-21
	25, 32	40	■	■			

1) More information: www.festo.com/x/topic/crc



Accessories

Adapter kit
HMVA, HMSV, HAVB

Material:
Wrought aluminium alloy
RoHS-compliant

 **Note**
The kit includes the individual mounting interface as well as the necessary mounting material.

Permissible drive/gripper combinations with adapter kit Download CAD data → www.festo.com

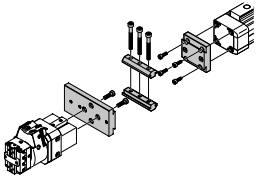
Combination	Drive Size	Gripper Size	Mounting option		Adapter kit		
					CRC ¹⁾	Part no.	Type
	DGPL	HGDS	■	■	2	177653	HMSV-7
						534290	HMSV-38
	DGPL-25	12, 16, 20	■	■		196788	HMVA-DLA1 8/25
						177653	HMSV-7
	DGPL-40	12, 16, 20	■	■		534290	HMSV-38
						196790	HMVA-DLA40

1) More information: www.festo.com/x/topic/crc

Accessories



Adapter kit
DHAA, HAPG, HMSV

Material:
Wrought aluminium alloy
Free of copper and PTFE
RoHS-compliant

 **Note**
The kit includes the individual mounting interface as well as the necessary mounting material.

Permissible drive/gripper combinations with adapter kit

Download CAD data → www.festo.com

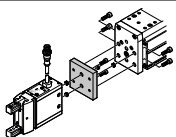
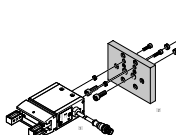
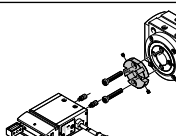
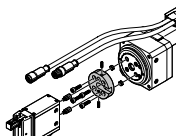
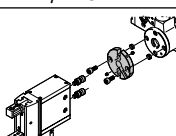
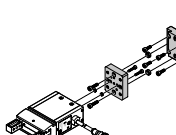
Combination	Drive Size	Gripper Size	Mounting option		Adapter kit			
					CRC ¹⁾	Part no.	Type	
EGSC/EHPS	EGSC	EHPS			HMSV			
	60	16, 20	■	■	2	8106581	DHAA-G-E8-60-B18-16	
EGSL/EHPS	EGSL	EHPS			HMSV			
	45, 55	16	■	■	2	548785	HMSV-55	
	75	20, 25	■	■		548786	HMSV-56	
ERMB/EHPS	ERMB	EHPS			HAPG			
	20	16, 20	■	■	2	184479	HAPG-SD2-3	
	25	16, 20	■	■		184482	HAPG-SD2-6	
	20	25	■	■		184480	HAPG-SD2-4	
	25	25	■	■		184483	HAPG-SD2-7	
	32	25	■	■		184485	HAPG-SD2-9	
ERMO/EHPS	ERMO	EHPS			DHAA			
	16	16	■	■	2	8079173	DHAA-G-R3-16-B18-16	
	25	16, 20	■	■		8071956	DHAA-G-R3-25-B18-16	
	32	20	■	■		8079214	DHAA-G-R3-32-B18-20	
	32	25	■	■		8079208	DHAA-G-R3-32-B18-25	
EHMB/EHPS	EHMB	EHPS			HAPG			
	20	25	■	■	2	184485	HAPG-SD2-9	
	25, 32	25	■	■		8078739	DHAA-G-H1-25-B18-25	
DGPL/EHPS	DGPL	EHPS			HMVA, HAPG, HMSV			
	Direct mounting				2			
	25, 32	16	■	■		196788	HMVA-DLA18/25	
						193922	HAPG-37-S4	
	40	16	■	■		196790	HMVA-DLA40	
					193922	HAPG-37-S4		
	Dovetail mounting				2			
	25	16	■	■		196788	HMVA-DLA18/25	
						177768	HMSV-28	
	40	16, 20	■	■		196790	HMVA-DLA40	
					177768	HMSV-28		
40	25	■	■	196790	HMVA-DLA40			
				177769	HMSV-29			

1) More information: www.festo.com/x/topic/crc



Accessories

Adapter kit
DHAA, HAPG, HMSV

Material:
Wrought aluminium alloy
Free of copper and PTFE
RoHS-compliant

 **Note**

The kit includes the individual mounting interface as well as the necessary mounting material.

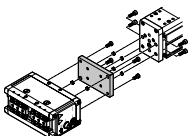
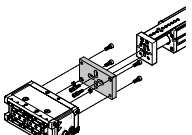
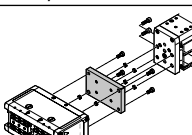
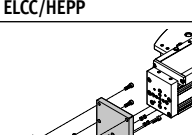
Permissible drive/gripper combinations with adapter kit						Download CAD data → www.festo.com	
Combination	Drive Size	Gripper Size	Mounting option		Adapter kit CRC ¹⁾	Part no.	Type
							
	EGSC	HEPP			HMSV 2	8150924	DHAA-G-E19-32-B24-28
	32, 45, 60	28	■	■			
	45, 60	36	■	■			
	EGSL	HEPP			HMSV 2	8150917	DHAA-G-E8-35-B24-28
	35	28	■	■			
	45, 55, 75	28	■	■			
	55, 75	36	■	■			
	ERMB	HEPP			HAPG 2	8154540	DHAA-G-R1-20-B24-28
	20	28	■	■			
	25	28	■	■			
	20	36	■	■			
	25	36, 42	■	■			
	32	42	■	■			
	ELCC	HEPP			DHAA 2	8150928	DHAA-G-E21-60-B24-28
	60	28	■	■			
	70	28	■	■			
	60	36	■	■			
	70	36	■	■			
	90	36	■	■			
	70	42	■	■			
	90, 110	42	■	■			

1) More information: www.festo.com/x/topic/crc