

## Valve terminal VTEP

**FESTO**

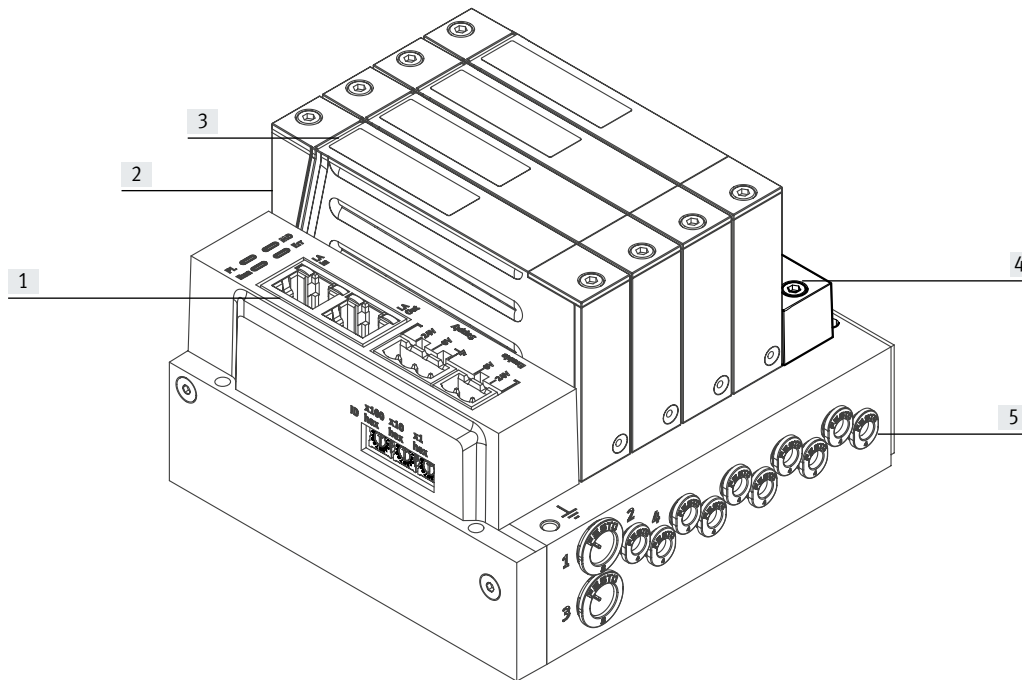

Key features



[1] Simple electrical connections via EtherCAT  
 [2] 16 mm grid dimension

[3] Simplified diagnostics thanks to LED status display on the valve

[4] Flexible:  
 2 ... 10 channels, 1 ... 5 valves

[5] Practical:  
 Push-in tubing connectors integrated into the manifold sub-base

**Innovative**

- Very compact: 10 channels on an overall width of less than 120 mm width
- Highly dynamic precision control
- Pressure and vacuum control can be combined
- Very flexible thanks to customisable control parameters
- Option for parallel connection of channels integrated in the software. This multiplies the flow rate without affecting the pressure control.

**Piezo technology**

- No wear
- No tear
- No particle abrasion
- No heat generation
- Silent
- Low power consumption
- Low air consumption

**Reliable**

- EtherCat communication interface
- Flow rate up to 35 l/min
- Fast troubleshooting with LEDs on the valves
- Easy to service thanks to replaceable valves

**Easy to install**

- Push-in connectors securely integrated
- Supplied quickly and reliably as a ready-to-install, tested unit
- Reduced selection, ordering, installation and commissioning costs

**Ordering data – Product options**

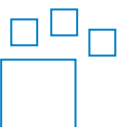

Configurable product  
 This product and all its product options can be ordered using the configurator.

The configurator can be found at  
 → [www.festo.com/catalogue/...](http://www.festo.com/catalogue/...)  
 Enter the part number or the type.

Part no. 8176050  
 Type VTEP

## Key features – Electrical/mechanical

## EtherCAT connection

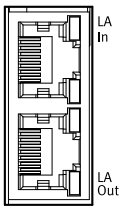

Communication with a higher-order PLC takes place via the integrated EtherCAT interface. The interfaces support crossover detection (auto MDI/MDI-X). This means either patch cables or crossover cables can be used.

The supported “distributed clocks” function, for precise synchronisation of participants in an EtherCAT network, enables applications that require simultaneously coordinated actions.

## Power supply

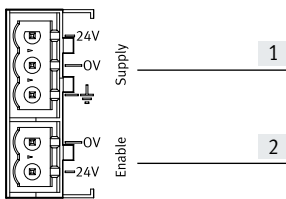

The valve terminal has a connection for the power supply for electronics and valves [1].

Connection [2] enables the supply voltage for the valves to be switched on or off separately.

## Sub-base valve

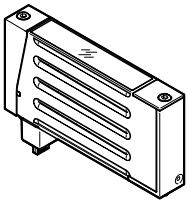

VTEP offers two different valves, one for high pressure and one for low pressure. The valves comprise four 2/2-way proportional valves connected to form a bridge circuit, two of which regulate the pressure in duct 2 and two of which regulate the pressure in duct 4.

Sensors monitor the degree of opening of the valves as well as the pressure in duct 2 and 4.

The valves are attached to the sub-base using two screws.

As a result, the valves can be easily replaced. The sturdy mechanical structure of the sub-base ensures efficient, durable sealing. The valve code (e.g. P, PL) is located on the front of the valve below the LED display.

## Cover plate

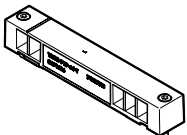

Cover plate (code B) without valve function, for reserving valve positions on a valve terminal.

The valve plate and cover plate are connected to the sub-base using two screws.

Cover plates can be replaced by valves at a later date. The dimensions, mounting points and existing pneumatic installations remain unchanged during this process.

## Compressed air supply and exhaust

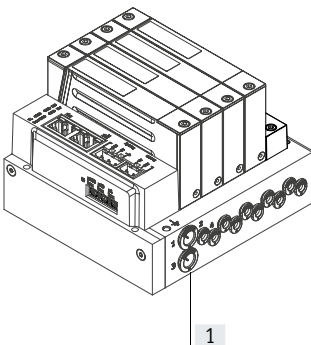

The valve terminal VTEP is supplied with pressure via the connections [1] in the manifold sub-base.

All pneumatic connections are integrated into the manifold sub-base.

## Key features – Display and operation

### Display and operation

Status display, valve

Status display, valve terminal

Each valve has an LED to display the valve status.

The valve terminal has displays for:

- Module diagnostics
- Load voltage
- EtherCAT status
- Network status

### Display and operating components

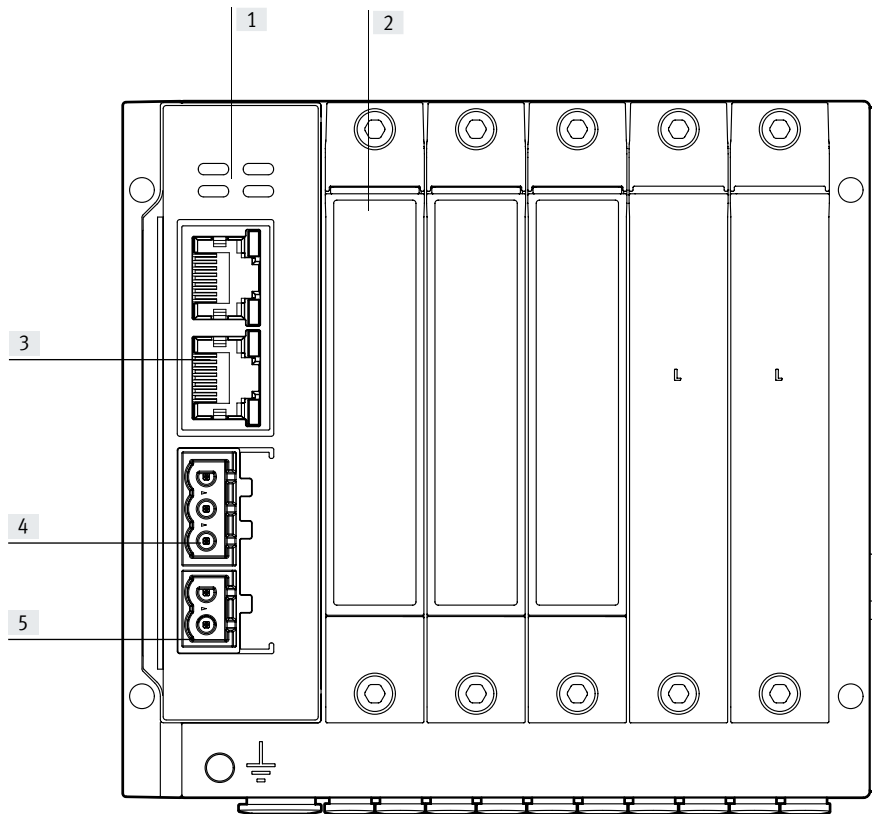

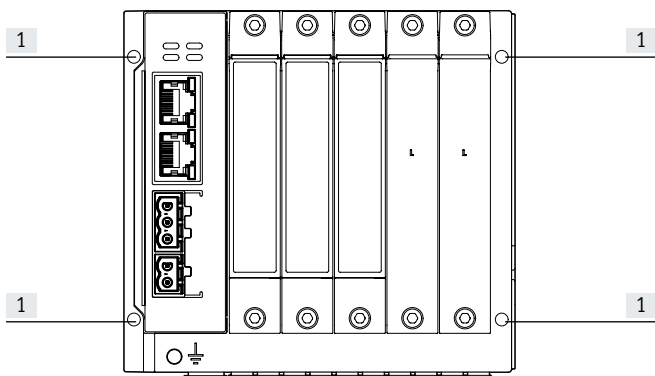

- [1] LED status indicators for the valve terminal
- [2] LED display on the valve
- [3] Ethernet interface
- [4] Power supply connection
- [5] Switching input for valve supply

### Valve terminal mounting



The manifold sub-base has four through-holes [1] for mounting the valve terminal.

## Datasheet – Valve terminal VTEP

-  - Flow rate  
up to 35 l/min
-  - Valve width  
16 mm
-  - Voltage  
24 V DC



## General technical data

Application note	The product is suitable for industrial purposes only. In residential areas, measures for radio interference suppression may need to be taken; for indoor use only
Valve terminal design	Fixed grid
Grid dimension	16 mm
Max. no. of valve positions	5
Max. no. of pressure zones	1
Valve function	3-way proportional-pressure regulator, closed
Actuation type	Electrical
Setpoint value input	Digital
Sealing principle	Soft
Standard flow rate	16 ... 35 l/min
Flow direction	Not reversible
Suitable for vacuum	Yes
Display type	LED
Linearity	0.4 ... 0.9 %FS
Hysteresis	0.4 ... 0.5 %FS
Reproducibility	0.3 ... 0.4 %FS
Overall accuracy	0.65%FS 1.1%FS
Dimensions W x L x H	71 mm x 110 mm x 81.6 mm 87 mm x 110 mm x 81.6 mm 119 mm x 110 mm x 81.6 mm

## Technical data – Fieldbus interface

Fieldbus interface, type of connection	2 x socket
Fieldbus interface, connection technology	RJ45
Fieldbus interface, protocol	EtherCAT

## Technical data – Electrical connection 1

Electrical connection 1, function	Power supply
Electrical connection 1, connection type	Socket
Electrical connection 1, connection technology	Terminal strip
Electrical connection 1, number of pins/wires	3
Electrical connection 1, conductor cross section	0.2 ... 1.5 mm <sup>2</sup>

## Datasheet – Valve terminal VTEP

## Technical data – Electrical connection 2

Electrical connection 2, function	Digital input
Electrical connection 2, connection type	Socket
Electrical connection 2, connection technology	Terminal strip
Electrical connection 2, number of pins/wires	2
Electrical connection 2, conductor cross section	0.2 ... 1.5 mm <sup>2</sup>

## Technical data – Electrics

Nominal operating voltage DC	24 V
Operating voltage range DC	20.4 ... 27.6 V
Overvoltage category	II
Max. electrical power consumption	6 W
Buffer time in case of voltage failure of logic supply	10 ms
Residual ripple	± 10%
Pollution degree	2
Reverse polarity protection	For all electrical connections
Protection against direct and indirect contact	PELV

## Pneumatic connections

Pneumatic connection 1	For tubing O.D. 8 mm
Pneumatic connection 2	For tubing O.D. 4 mm
Pneumatic connection 3	For tubing O.D. 8 mm
Pneumatic connection 4	For tubing O.D. 4 mm

## Materials

Sealing material	NBR
Note on materials	RoHS-compliant
LABS (PWS) conformity	VDMA24364 zone III
Suitable for the production of Li-ion batteries	Metals with more than 5% by mass of copper, zinc or nickel are excluded from use. Exceptions are nickel in steel, chemically nickel-plated surfaces, printed circuit boards, cables, electrical plug connectors and coils
Cleanroom class	Class 3 to ISO 14644-1
Fire tested	UL94 HB

## Pressure specifications

Operating pressure	0.2 ... 0.7 MPa
Operating pressure	2 ... 7 bar
Operating pressure	29 ... 101.5 psi
Input pressure 1	0 ... 0.7 MPa
Input pressure 1	0 ... 7 bar
Input pressure 3	-0.1 ... 0 MPa
Input pressure 3	-1 ... 0 bar
Pressure regulation range	-0.08 ... 0.6 MPa
Pressure regulation range	-0.8 ... 6 bar
Burst pressure	2.1 MPa
Burst pressure	21 bar
Burst pressure	304.5 psi

## Datasheet – Valve terminal VTEP

## Operating and environmental conditions

Operating medium	Compressed air to ISO 8573-1:2010 [7:4:4], inert gases, oxygen
Ambient temperature	5 ... 50°C
Temperature of medium	5 ... 50°C
Storage temperature	-20 ... 60°C
Relative humidity	5 - 85%; non-condensing
Corrosion resistance class CRC <sup>1)</sup>	2 - Moderate corrosion stress
Nominal operating altitude	< 3000 m above sea level
Climatic category	3K3 to EN 60721
Vibration resistant	Transport application test with severity level 2 to FN 942017-4 and EN 60068-2-6
Shock resistance	Shock test with severity level 2 to FN 942017-5 and EN 60068-2-27
CE marking (see declaration of conformity) <sup>2)</sup>	To EU EMC Directive To EU RoHS Directive
UKCA marking (see declaration of conformity) <sup>3)</sup>	To UK EMC regulations To UK RoHS regulations
KC marking	KC EMC
Certification	RCM
Degree of protection	IP20

1) More information [www.festo.com/x/topic/crc](http://www.festo.com/x/topic/crc)

2) More information [www.festo.com/catalogue/... Support/downloads](http://www.festo.com/catalogue/... Support/downloads).

3) More information [www.festo.com/catalogue/... Support/downloads](http://www.festo.com/catalogue/... Support/downloads).

## Datasheet – Valves VEVP

-  - Grid dimension  
16 mm

-  - Voltage  
24 V DC



## General technical data

Grid dimension	16 mm
Nominal width	4 mm
Design	Sub-base valve
Valve function	3-way proportional-pressure regulator, closed
Actuation type	Electrical
Sealing principle	Soft
Flow direction	Not reversible
Suitable for vacuum	Yes
Product weight	85.5 g

## Technical data – Electrics

Nominal operating voltage DC	24 V
------------------------------	------

## Pneumatic connections

Pneumatic connection 1	Flange
Pneumatic connection 2	Flange
Pneumatic connection 3	Flange
Pneumatic connection 4	Flange

## Materials

Housing material	PA66-GF30, TPE-U(PU)
Sealing material	NBR
Note on materials	RoHS-compliant
LABS (PWIS) conformity	VDMA24364 zone III
Suitable for the production of Li-ion batteries	Metals with more than 5% by mass of copper, zinc or nickel are excluded from use. Exceptions are nickel in steel, chemically nickel-plated surfaces, printed circuit boards, cables, electrical plug connectors and coils
Cleanroom class	Class 3 to ISO 14644-1

## Pressure specifications – Valves VEVP

Pressure range	0 ... 3 bar	0 ... 7 bar
Operating pressure	0.2 MPa	0.7 MPa
Operating pressure	2 bar	7 bar
Operating pressure	29 psi	101.5 psi
Standard flow rate (standardised according to DIN 1343)	16 l/min	35 l/min

## Operating and environmental conditions

Ambient temperature	5 ... 50°C
Temperature of medium	5 ... 50°C
Storage temperature	-20 ... 70°C
Relative humidity	5 - 90%, non-condensing
Climatic category	3K3 to EN 60721
Vibration resistant	Transport application test with severity level 2 to FN 942017-4 and EN 60068-2-6
Shock resistance	Shock test with severity level 2 to FN 942017-5 and EN 60068-2-27
Degree of protection	IP65



Datasheet

Dimensions

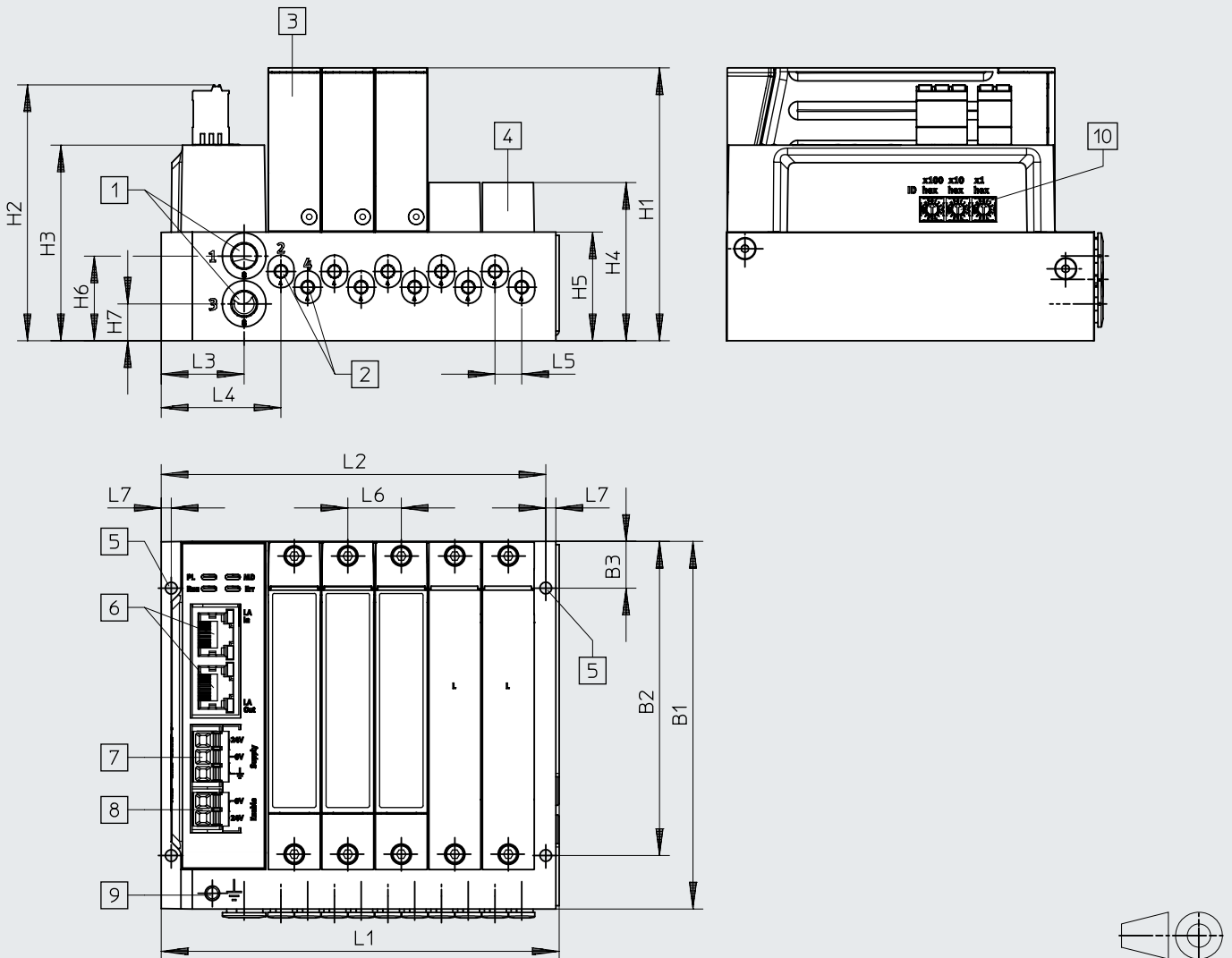

Download CAD data → [www.festo.com](http://www.festo.com)



- [1] Supply ports
- [2] Working ports
- [3] Solenoid valve VEVP
- [4] Cover plate
- [5] Mounting holes
- [6] EtherCAT connection
- [7] Power supply connection
- [8] Switching input for valve supply
- [9] Earth connection
- [10] Addressing switch for EtherCAT

Type	Number of valve positions	B1	B2	B3	H1	H2	H3	H4	H5	H6	H7	L1	L2	L3	L4	L5	L6	L7
VTEP	2	110	94	14	81.6	76.5	58.5	47.3	32.5	25.3	11	71	67	24.8	35.8	8	16	3
	3											87	83					
	5											119	115					

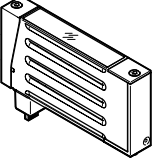
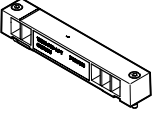
## Accessories

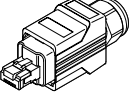
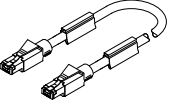
Ordering data		Code			Part no.	Type
<b>Piezo valve, individual</b>						
	Function P	Operating pressure 0.7 MPa	Standard flow rate 35 l/min		8184034	VEVP-XA-4-B-T32C-F-D31-2
	Function: PL	Operating pressure 0.2 MPa	Standard flow rate 35 l/min		8184037	VEVP-XA-4-B-T32C-F-D22-2
<b>Vacant position</b>						
	Valve type 1-5: B	Cover plate for one valve position			8154656	VABB-P19-16-T
<b>Control cabinet through-feed</b>						
	-	Straight socket, 4-pin, M12x1, D-coded	Straight socket, 4-pin, M12x1, D-coded		8040459	NEFU-D12G4-D12DG4
			Angled socket, 8-pin, RJ45		8040457	NEFU-D12G4-R3DW4
<b>Plug</b>						
	-	RJ45 plug, 8-pin, push-pull			552000	FBS-RJ45-PP-GS
<b>Connecting cable</b>						
	-	Straight plug, RJ45, 8-pin	Straight plug, RJ45, 8-pin	0.2 m	★ 8082383	NEBC-R3G8-KS-0.2-N-S-R3G8-ET
				1 m	8040455	NEBC-R3G4-ES-1-S-R3G4-ET