

Standard Filters MS4N-LF – Inch Series



Standard filters, with filtration grades of 5 microns or 40 microns, are equipped with a water separator that cleans the compressed air of impurities, rust, and condensate. For pre-filtering in pneumatic systems or for special applications.

- Pneumatic connection: 1/8 NPT, 1/4 NPT, 3/8 NPT
- Supply pressure
 - For manual drain: 0 ... 235 psi
 - For semiautomatic drain: 22 ... 176 psi
 - For fully automatic drain: 29 ... 176 psi
- Flow rate: 35.3 ... 60.0 scfm

Product Range Overview													
Type	Pneumatic connections		Filtration grade [µm]				Bowl guard		Bowl drain			Contamination control	Reverse flow
	Body thread	Port plate	0.01	1	5	40	Plastic bowl guard	Metal bowl	Manual	Semiautomatic	Fully automatic	Differential pressure indicator	Flow direction from right to left
MS4N		AG...	A	B	C	E	R	U	M	H	V	DA	Z
LF	1/8 NPT, 1/4 NPT	1/8 NPT, 1/4 NPT, 3/8 NPT	-	-	■	■	■	■	■	■	■	-	■

Features

- Sintered filter with centrifugal separation removes contamination, rust and condensate from the compressed air.
- High flow rate with minimal pressure drop
- Replaceable filter cartridges

Contents

Technical Data	→ 224
Dimensional Drawings	→ 228
Ordering Data	→ 229
Accessories	→ 232
Replacement Parts	→ 240

→ www.festo.com/catalog/ms4n-lf

Standard Filters MS4N-LF – Inch Series

Technical Data

ISO Symbol

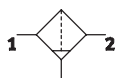

Manual bowl drain

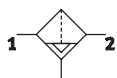

Semi or fully automatic bowl drain



General Technical Data			
Pneumatic connection 1, 2		1/8 NPT	1/4 NPT
Filtration grade	[µm]	5 (air purity class at the output 3.7.- to DIN ISO 8573-1) 40 (air purity class at the output 5.7.- to DIN ISO 8573-1)	
Supply pressure	M [psi]	0 ... 206 (manual drain)	
	H [psi]	22 ... 176 (semiautomatic drain)	
	V [psi]	29 ... 176 (fully automatic drain)	

Standard Nominal Flow Rate qnN ¹⁾ [scfm]			
Pneumatic connection 1, 2		1/8 NPT	1/4 NPT
Filtration grade	5 µm	35.3	45.9
	40 µm	38.8	60.0

1) Measured at p₁ = 88 psi and Δp = 15 psi

Standard Filters MS4N-LF – Inch Series

Technical Data



Operating and Environmental Conditions			
Bowl drain	Manual M	Semiautomatic H	Fully automatic V
Operating medium	Compressed air		
Max. condensate volume [in ³]	1.16 (with plastic bowl guard) 1.53 (with metal bowl)		
Bowl guard	Plastic bowl guard		
	Metal bowl		
Ambient temperature [°F]	14 ... 140	41 ... 140	41 ... 140
Temperature of medium [°F]	14 ... 140	41 ... 140	41 ... 140
Storage temperature [°F]	14 ... 140	14 ... 140	14 ... 140
Assembly position	Vertical ±5°		
Corrosion resistance CRC ¹⁾	2		

- 1) Corrosion resistance class 2 according to Festo standard 940 070
Components requiring moderate corrosion resistance. Externally visible parts with primarily decorative surface requirements which are in direct contact with a normal industrial environment or media such as coolants or lubricating agents.

Weights [lb]	
With plastic bowl guard	0.38
With metal bowl	0.70

- Wearing parts kits → 240
- Filter cartridges → 240
- For spare parts go to: www.festo.com/en/spare_parts_service

Standard Filters MS4N-LF – Inch Series

Technical Data



Standard Flow Rate q_n as a Function of the Differential Pressure Δp_{1-2}

MS4N-LF-1/8

Filtration grade 5 μm

Filtration grade 40 μm

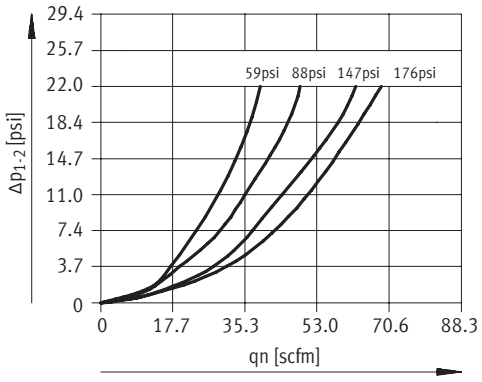
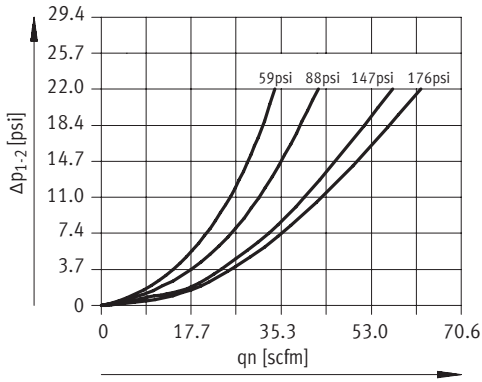

MS4N-LF-1/4

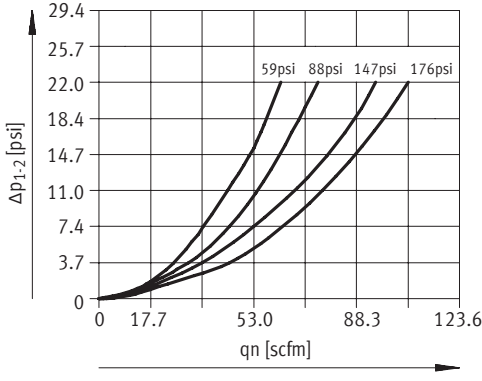
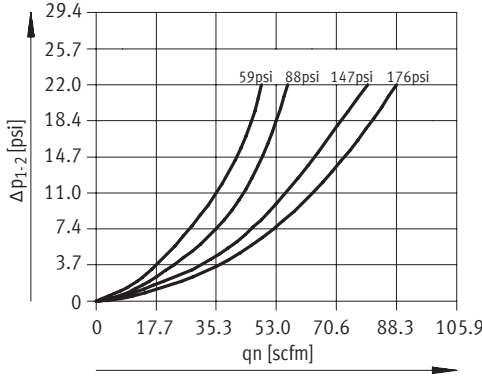

Standard Filters MS4N-LF – Inch Series

Technical Data

Materials

Sectional view

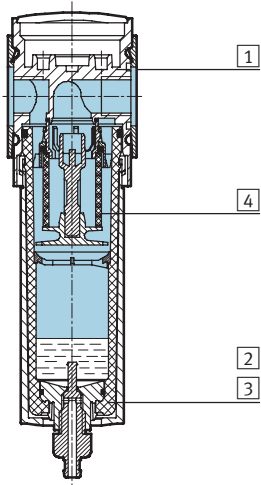

Filters		
1	Body	Die-cast aluminum
2	Plastic bowl guard	Polycarbonate/polyamide
3	Metal bowl Viewing window	Aluminum Polyamide
4	Filter element	Polyethylene
-	Seals	Nitrile rubber
Note on materials		Free of copper and PTFE

Standard Filters MS4N-LF – Inch Series

Dimensional Drawings



Dimensions¹⁾ – Standard Download CAD Data → www.festo.com/us/cad

Manual bowl drain

1) Installation dimensions
→ Flow direction

Type	B1	B2	B3	D1	L1		L2	L3	L5	L6	
					Bowl guard					Plastic	Metal
					Plastic	Metal					
MS4N-LF-1/8	1.57	0.83	2.13	1/8 NPT	5.62	6.28	1.14	2.38	0.98	0.70	0.70
MS4N-LF-1/4				1/4 NPT							

1) Dimensions are in inches, unless otherwise noted.

Dimensions¹⁾ – Bowl Drain Download CAD Data → www.festo.com/us/cad

Manual M		Semiautomatic H		Fully automatic V	
	Barbed fitting for plastic tubing PCN-4		QS fitting for plastic tubing PUN-6/PAN-6		Barbed fitting for plastic tubing PCN-4
Type	L6	Type	L6	Type	L6
Plastic bowl guard		Plastic bowl guard		Plastic bowl guard	
MS4N-LF-...-M	0.70	MS4N-LF-...-H	0.87	MS4N-LF-...-V	0.80
Metal bowl		Metal bowl		Metal bowl	
MS4N-LF-...-M	0.70	MS4N-LF-...-H	0.87	MS4N-LF-...-V	0.80

1) Dimensions are in inches, unless otherwise noted.

Standard Filters MS4N-LF – Inch Series

Ordering Data – Pre-configured Products



Ordering Data								
Bowl drain	Connection	Filtration grade 5 µm				Filtration grade 40 µm		
		Part No.	Type	LT	Part No.	Type	LT	
Plastic bowl guard								
Manual	1/8 NPT	531490	MS4N-LF-1/8-CRM	1D	531486	MS4N-LF-1/8-ERM	Q	
	1/4 NPT	531489	MS4N-LF-1/4-CRM	1D	531485	MS4N-LF-1/4-ERM	Q	
Fully automatic	1/8 NPT	531494	MS4N-LF-1/8-CRV	1D	531482	MS4N-LF-1/8-ERV	Q	
	1/4 NPT	531493	MS4N-LF-1/4-CRV	1D	531481	MS4N-LF-1/4-ERV	Q	
Metal bowl								
Manual	1/8 NPT	535670	MS4N-LF-1/8-CUM	Q	535676	MS4N-LF-1/8-EUM	Q	
	1/4 NPT	535686	MS4N-LF-1/4-CUM	Q	535692	MS4N-LF-1/4-EUM	Q	
Fully automatic	1/8 NPT	535672	MS4N-LF-1/8-CUV	Q	535674	MS4N-LF-1/8-EUV	Q	
	1/4 NPT	535688	MS4N-LF-1/4-CUV	Q	535690	MS4N-LF-1/4-EUV	Q	

LT = Lead time

1D typically ships same day/next day

1W typically ships within 1 week

Q request a quote for lead time

Standard Filters MS4N-LF – Inch Series

Ordering Data – Configurable Products



M Mandatory Data →

Part No.	Series	Size	Thread	Function	Connection size	Filtration grade	Bowl
527696	MS	4	N	LF	1/8, 1/4, AQK, AQN, AQP	E C	R U
Order example							
527696	MS	4	N	- LF	- AQK	- E	- R

Ordering Table

Grid dimension	[mm]	40	Conditions	Code	Enter code
M Part No.		527696			
Series		Standard		MS	MS
Size		4		4	4
Thread		NPT thread		N	N
Function		Filters		-LF	-LF
Connection size		Body thread 1/8 NPT		-1/8	
		Body thread 1/4 NPT		-1/4	
		Port plate 1/8 NPT (dimensions → 236)		-AQK	
		Port plate 1/4 NPT (dimensions → 236)		-AQN	
		Port plate 3/8 NPT (dimensions → 236)		-AQP	
Filtration grade		40 µm		-E	
		5 µm		-C	
Bowl		Plastic bowl with plastic bowl guard		-R	
		Metal bowl		-U	

Transfer order code

Standard Filters MS4N-LF – Inch Series

Ordering Data – Configurable Products

→ M Mandatory Data	O Options	
Bowl drain M H V	Type of mounting WP WPM WB WBM	Reverse flow direction Z
- M	- WP	- Z

Ordering Table			
Grid dimension	[mm]	40	Conditions Code Enter code
↓ M	Bowl drain	Manual	-M
		Semiautomatic (P1 max. 176 psi)	-H
		Fully automatic (P1 max. 176 psi)	-V
O	Type of mounting	Mounting bracket (dimensions → 237)	1 -WP
		Mounting bracket (dimensions → 237)	1 -WPM
		Mounting bracket (dimensions → 234)	-WB
		Mounting bracket (dimensions → 234)	-WBM
	Reverse flow direction	Flow direction from right to left	-Z

1 WP, WPM Only with port plate AQK, AQN or AQP

Transfer order code

- - -

Standard Filters MS4N-LF – Inch Series

Accessories Overview

Mounting Attachments and Accessories

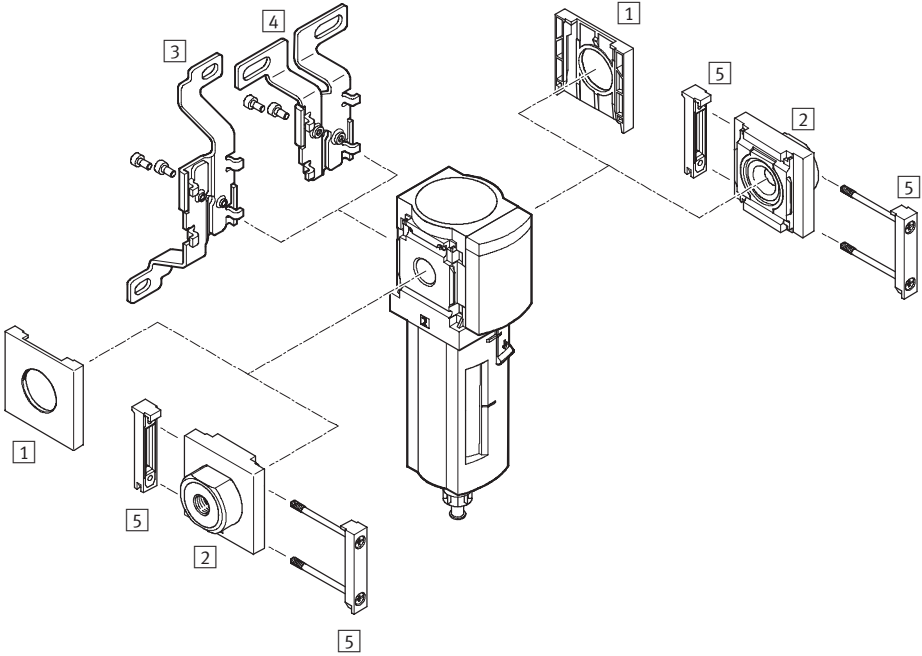

Single unit and combination unit mounting brackets.

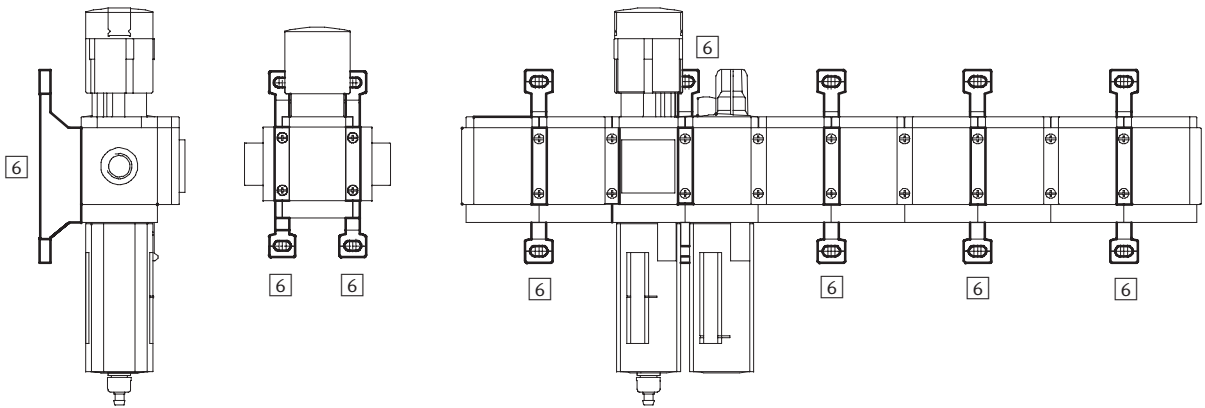

Standard Filters MS4N-LF – Inch Series

Accessories Overview



Mounting Attachments and Accessories						
		Single unit		Combination unit → 2.1-49		→ Page
		without port plate	with port plate	without port plate	with port plate	
1	Cover cap MS4-END	■	-	■	-	235
2	Port plate MS4N-AQ...	-	■	-	■	236
3	Mounting bracket MS4-WB	■	■	-	-	234
4	Mounting bracket MS4-WBM	■	■	-	-	234
5	Body connector MS4-MV	-	■	■	■	236
6	Mounting bracket MS4-WP/WPB/WPM	-	■	■	■	237

Standard Filters MS4N-LF – Inch Series



Accessories

3 Mounting bracket MS4-WB

- For wall mounting

Material:
Steel

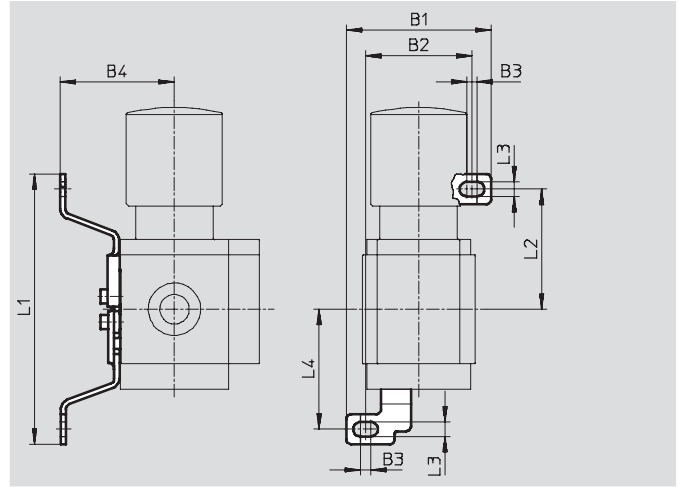

Dimensions and Ordering Data										
B1	B2	B3	B4	L1	L2	L3	L4	Weight [lb]	Part No.	Type
2.21	1.62	0.16	1.74	4.12	1.83	0.22	1.79	0.09	532185	MS4-WB

4 Mounting bracket MS4-WBM

- For wall mounting

Material:
Steel

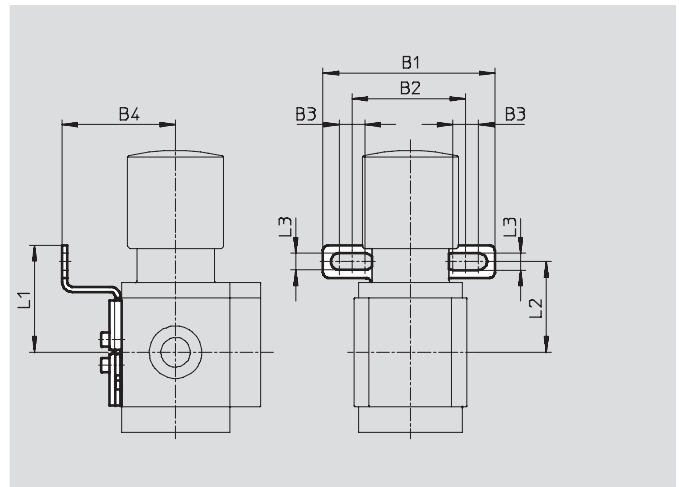

Dimensions and Ordering Data									
B1	B2	B3	B4	L1	L2	L3	Weight [lb]	Part No.	Type
2.62	1.73	0.39	1.73	1.63	1.38	0.26	0.10	526062	MS4-WBM

Standard Filters MS4N-LF – Inch Series

Accessories

1 Cover cap MS4-END

- Can be used to cover the body sides of the first and last module if port plates are not used.

Material:
Reinforced polyamide
Free of copper and PTFE

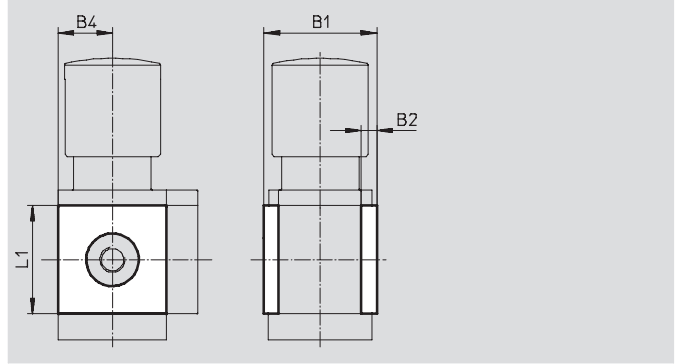

Dimensions and Ordering Data						
B1	B2	B4	L1	Part No.	Type	
1.72	0.24	0.83	1.65	538779	MS4-END	

Mounting plate MS4-AEND

- In combination with mounting bracket MS-WP or MS-WPB for mounting an individual unit with body thread on a wall

Material:
Reinforced polyamide
Conforms to RoHS
Free of copper and PTFE

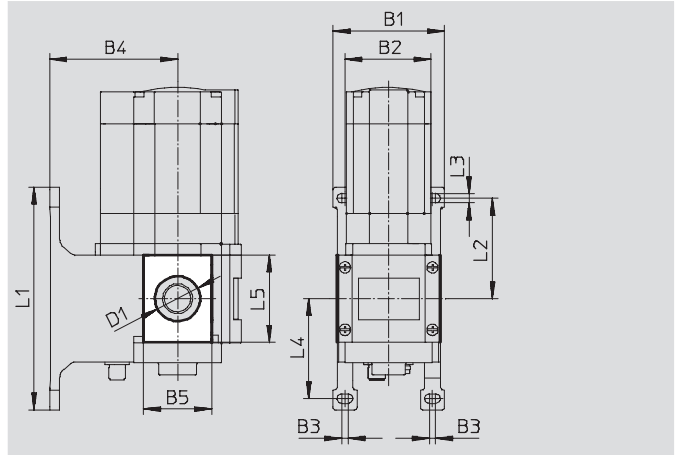

Dimensions and Ordering Data															
B1	B2	B3	B4		B5	D1 ∅	L1	L2	L3	L4	L5	CRC ¹⁾	Weight [lb]	Part No.	Type
			WP	WPB											
2.17	1.58	0.16	1.73	2.60	1.20	0.80	4.17	1.83	0.22	1.84	1.65	2	0.01	542966	MS4-AEND

1) Corrosion resistance class 2 according to Festo standard 940 070
Components requiring moderate corrosion resistance. Externally visible parts with primarily decorative surface requirements which are in direct contact with a normal industrial environment or media such as coolants or lubricating agents.

Standard Filters MS4N-LF – Inch Series

Accessories

2 Port plate MS4N-AQ...

- Adapter for pneumatic connection

Material:
Aluminum

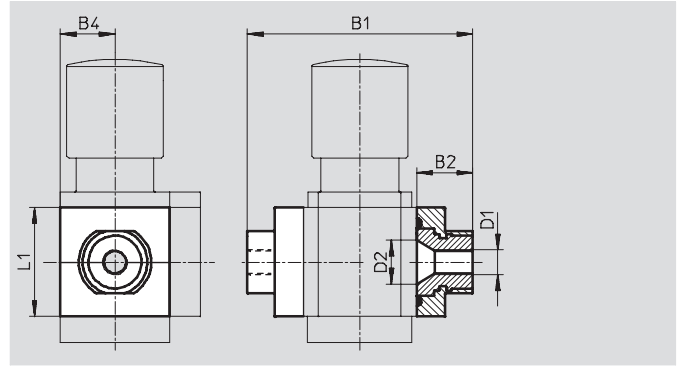

Dimensions and Ordering Data								
B1	B2	B4	D1	D2	L1	Weight [lb]	Part No.	Type
3.29	0.85	0.83	1/8 NPT	0.66	1.65	0.26	526065	MS4N-AQK
			1/4 NPT				526066	MS4N-AQN
			3/8 NPT				526067	MS4N-AQP

5 Body connector MS4-MV

- For connecting modules

Material:
Stainless steel/polyacetate



Ordering Data		
Weight [lb]	Part No.	Type
0.07	532798	MS4-MV

Standard Filters MS4N-LF – Inch Series

Accessories



6 Mounting Bracket MS4-WP...

Suggested placement of wall mounting brackets when mounting air preparation combinations

1 unit: 1.575 in

2 units: 3.15 in

Number of units

1 2 3 4 5 6 7 8 9 10

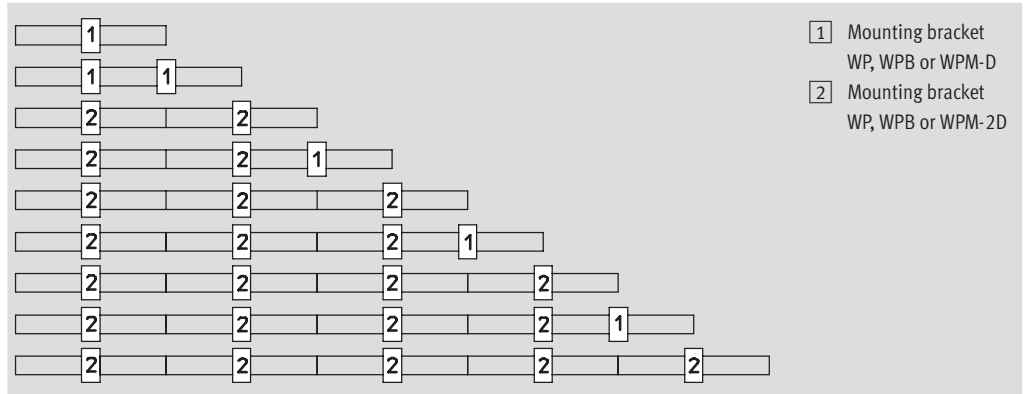

Mounting dimensions

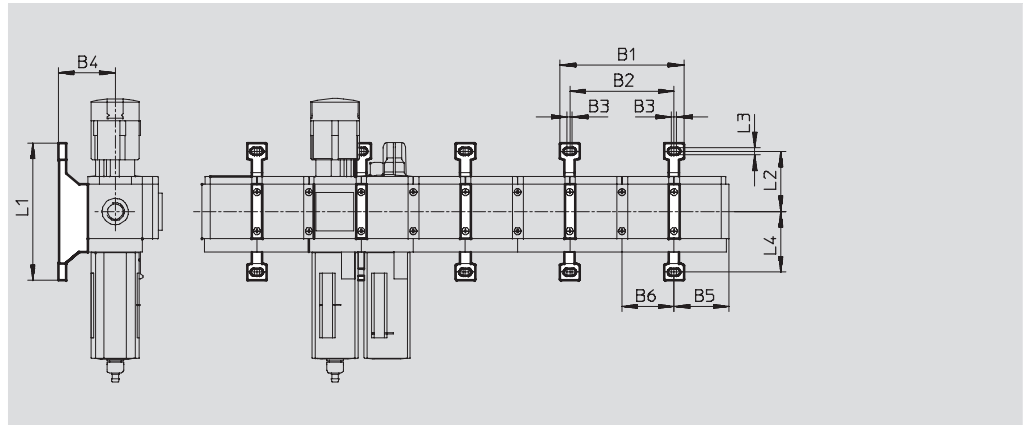

Type	B1	B2	B3	B4	B5	B6	L1	L2	L3	L4
MS4-WP	3.75	3.15	0.16	1.73	1.65	1.57	4.17	1.83	0.22	1.84
MS4-WPB				2.60						1.57
MS4-WPM-...D				1.73						1.57

Standard Filters MS4N-LF – Inch Series



Accessories

Mounting bracket MS4-WP

- To connect the modules for wall mounting
- In combination with a port plate MS-AG... for mounting an individual unit on a wall
- In combination with mounting plate MS-AEND or for mounting an individual unit with body thread on a wall
- For pressure regulator LRB with angled outlet block B... at rear

Material:
Die-cast aluminum

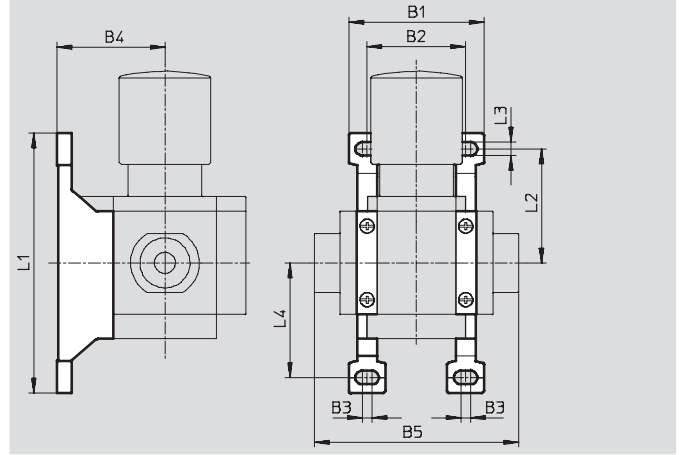

Dimensions and Ordering Data											
B1	B2	B3	B4	B5	L1	L2	L3	L4	Weight [lb]	Part No.	Type
2.17	1.58	0.16	1.73	3.28	4.17	1.83	0.22	1.84	0.08	532184	MS4-WP

Mounting bracket MS4-WPB

- To connect the modules for wall mounting
- In combination with a port plate MS-AG... for mounting an individual unit on a wall
- In combination with mounting plate MS-AEND or for mounting an individual unit with direct thread on a wall
- Provides large wall gap for pressure regulator

Material:
Die-cast aluminum

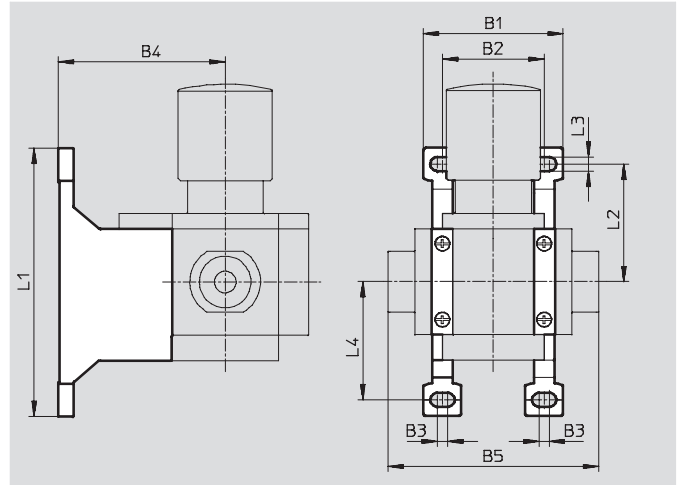

Dimensions and Ordering Data											
B1	B2	B3	B4	B5	L1	L2	L3	L4	Weight [lb]	Part No.	Type
2.17	1.58	0.16	2.60	3.28	4.17	1.83	0.22	1.84	0.11	526063	MS4-WPB

Standard Filters MS4N-LF – Inch Series

Accessories

Mounting bracket MS4-WPM

- To connect the modules for wall mounting
- In combination with a port plate MS-AG... for mounting an individual unit on a wall
- Speedy attachment and detachment
- For installation of modules with regulating knob pointing downwards

The distance piece D or 2D (designated in the type code) is included in the scope of delivery and ensures the correct clearance

Material:
Die-cast aluminum

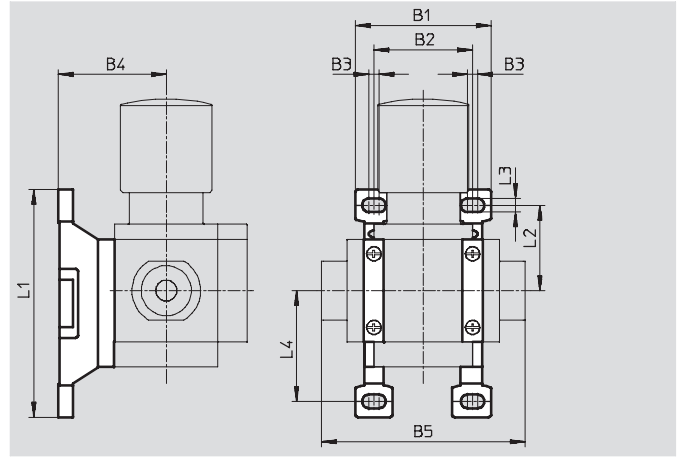

Dimensions and Ordering Data												
B1	B2	B3	B4	B5	L1	L2	L3	L4	Clearance	Weight [lb]	Part No.	Type
2.17	1.57	0.16	1.73	3.28	3.65	1.37	0.22	1.78	1.57	0.09	526060	MS4-WPM-D
3.75	3.15			4.86					3.15	0.11	526061	MS4-WPM-2D

Body connector MS4-MVM

- For installation of modules with regulating knob pointing downwards

Material:
Die-cast aluminum



Ordering Data		
Size	Part No.	Type
MS4	532800	MS4-MVM

Standard Filters MS4N-LF – Inch Series



Replacement Parts

Ordering Data – Wearing Parts Kits			
Size	Description	Part No.	Type
MS4	O-rings, screws, sealing ring	673639	MS4-LF



Ordering Data – Filter Cartridges			
Size	Filtration grade [µm]	Part No.	Type
MS4	5	534501	MS4-LFP-C
	40	534502	MS4-LFP-E

- For spare parts go to: www.festo.com/en/spare_parts_service

Festo - Your Partner in Automation



1 Festo Inc.
5300 Explorer Drive
Mississauga, ON L4W 5G4
Canada

Festo Customer Interaction Center
Tel: 1 877 463 3786
Fax: 1 877 393 3786
Email: customer.service.ca@festo.com



2 Festo Pneumatic
Av. Ceylán 3,
Col. Tequesquináhuac
54020 Tlalnepantla,
Estado de México

Multinational Contact Center
01 800 337 8669
ventas.mexico@festo.com



3 Festo Corporation
1377 Motor Parkway
Suite 310
Islandia, NY 11749

Festo Customer Interaction Center
1 800 993 3786
1 800 963 3786
customer.service.us@festo.com



4 Regional Service Center
7777 Columbia Road
Mason, OH 45040

Connect with us



www.festo.com/socialmedia



www.festo.com

Subject to change