

Connecting cables for valves, socket type C to EN 175301-803

FESTO

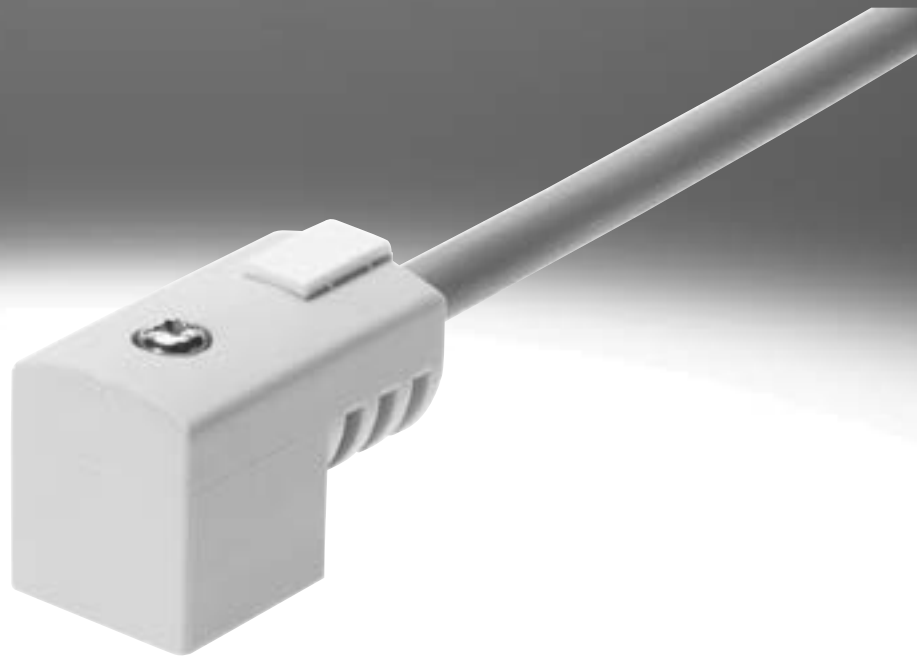

Festo Core Range
Solves the majority of your automation tasks

With the Festo Core Range, we have selected the most important products and functions from our broad product catalogue, and added the quickest delivery.

Worldwide: Quickest delivery – wherever, whenever
Simply good: Expected high Festo quality
Fast: Easy and fast to select

The Core Range offers you the best value for your automation tasks.

Just look
for the
star!

Type codes

001	Series	
KMEB	Connecting cable	
002	Variant	
1	Variant 1	
2	Variant 2	
3	Variant 3	
003	Rated operating voltage	
24	24 V DC	
230	230 V AC	
230AC	230 V AC	

004	Connection technology on the right, controller side	
	Open end	
M12	Plug M12x1 A-coded, EN 61076-2-101	
005	Cable length [m]	
0.5	0.5	
2.5	2.5	
5	5	
10	10	
006	Display	
	No display	
LED	LED signal status, DC	

Data sheet

Connecting cable KMEB

- For valves with EB solenoid coil
- Pre-assembled
- Cable lengths 2.5 m, 5 m and 10 m
- 24 V DC with LEDs and protective circuit
- Not suitable for energy chains
- KMEB-1 with PVC cable
- KMEB-2 with PUR cable
- KMEB-3 with PVC cable

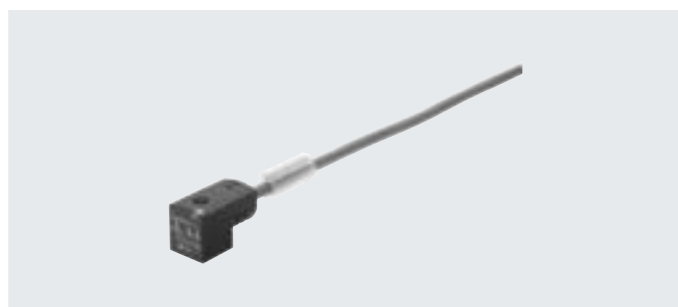

General technical data				
Type	KMEB-1	KMEB-2	KMEB-2-24-M12	KMEB-3
Electrical connection	Angled socket	Angled socket	Angled socket	Angled socket
	3-pin	4-pin	5-pin	2-pin
	Type C	Type C	Type C	Type C
	To EN 175301-803	To EN 175301-803	To EN 175301-803	To EN 175301-803
Reverse polarity protection	–	–	–	For all electrical connections
Cable ø [mm]	5.2	6.2	4.6	5.2
Cable composition	3 x 0.5 mm ²	3 x 0.75 mm ²	3 x 0.5 mm ²	2 x 0.75 mm ²
Protective earth connection	Provided	Provided	Provided	Not provided
Type of mounting	On solenoid valve with M2.5 central screw	On solenoid valve with M2.5 central screw	On solenoid valve with M2.5 central screw	On solenoid valve with M2.5 central screw
Mounting position	Any	Any	Any	Any
Cable characteristic	–	–	–	Standard
Degree of protection	IP65	IP65	IP65	IP65
	To IEC 60529	To IEC 60529	To IEC 60529	To IEC 60529

Materials				
Type	KMEB-1	KMEB-2	KMEB-2-24-M12	KMEB-3
Housing	PA66-GF30	PA, POM	PA, POM	PC
Pin contact	Bronze	Bronze	Bronze	Silver-plated bronze
Cable sheath	PVC	TPE-U(PUR)	TPE-U (PU)	PVC
Note on materials	–	RoHS-compliant	–	–
PWIS conformity	VDMA24364-B2-L	VDMA24364-B2-L	VDMA24364-B2-L	VDMA24364-B2-L

Operating and environmental conditions					
Type	KMEB-1-24	KMEB-1-230AC	KMEB-2	KMEB-2-24-M12	KMEB-3
Ambient temperature [°C]	–20 ... +80	–20 ... +80	–20 ... +80	–5 ... +50	–20 ... +80
Corrosion resistance class CRC ¹⁾	1	1	–	–	1
CE marking (see declaration of conformity) ²⁾	To EU RoHS Directive	To EU Low Voltage Directive	To EU RoHS Directive	To EU RoHS Directive	To EU RoHS Directive
		To EU RoHS Directive			
UKCA marking (see declaration of conformity) ²⁾	To UK RoHS instructions	To UK regulations for electrical equipment	To UK RoHS instructions	To UK RoHS instructions	To UK RoHS instructions
		To UK RoHS instructions			

1) Corrosion resistance class CRC 1 to Festo standard FN 940070

Low corrosion stress. Dry indoor application or transport and storage protection. Also applies to parts behind covers, in the non-visible interior area, and parts which are covered in the application (e.g. drive trunnions).

2) Additional information is available at www.festo.com/catalogue/... → Support/Downloads.

Data sheet

Dimensions

Download CAD data → www.festo.com

KMEB-1

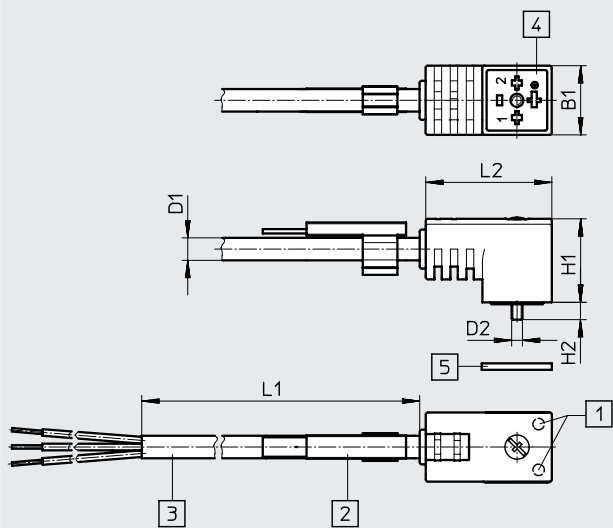

- [1] LED illuminated area (only with 24 V)
- [2] Inscription label holder ASCF with label ASLR-L-432 (scope of delivery)
- [3] 3-wire cable (3x 0.5 mm²)
- [4] Plug pattern to EN 175301-803, type C
- [5] Seal

Type	D1	D2	L1	L2	H1	H2	B1
KMEB-1-...-2.5	5.2	2.5	2500	29.1	19.3	4	16
KMEB-1-...-5	5.2	2.5	5000	29.1	19.3	4	16
KMEB-1-...-10	5.2	2.5	10000	29.1	19.3	4	16

KMEB-2

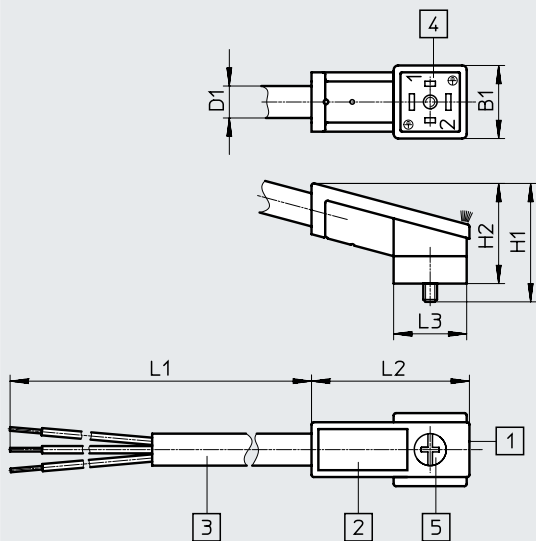

- [1] LED illuminated area (integrated)
- [2] Inscription label
- [3] 3-wire cable 2.5 m or 5 m (3x 0.75 mm²)
- [4] Plug pattern to EN 175301-803, type C
- [5] Seal

Type	B1	D1	H1	H2	L1	L2	L3
KMEB-2-...-2.5	16	6.2	26	22	2550	34.6	16
KMEB-2-...-5	16	6.2	26	22	5050	34.6	16

Data sheet

Dimensions

KMEB-2-24-M12

Download CAD data → www.festo.com

[1] 3-wire cable 0.5 m (3x 0.5 mm²)

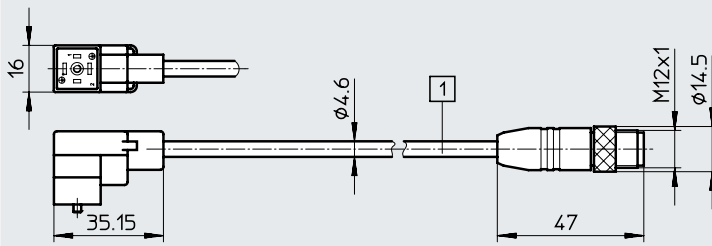

KMEB-3

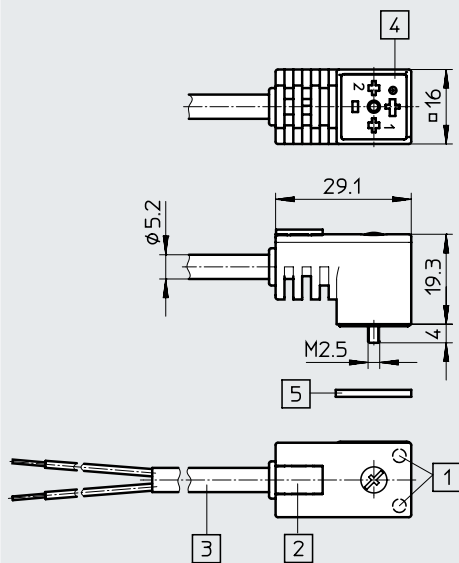

- [1] LED illuminated area
- [2] Inscription area
- [3] 2-wire cable
- [4] Plug pattern to EN 175301-803, type C
- [5] Seal

Circuitry

KMEB-1 and KMEB-3 with signal status indication

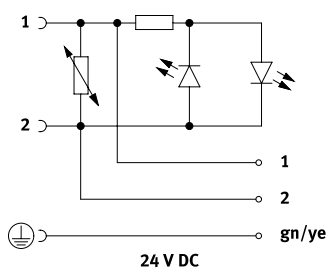

The 24 V DC version is reverse polarity protected and has a protective circuit for peak voltages of up to 100 V DC as well as an operating status indicator with yellow LED. (No gn/ye connection with KMEB-3)

KMEB-2-24-M12

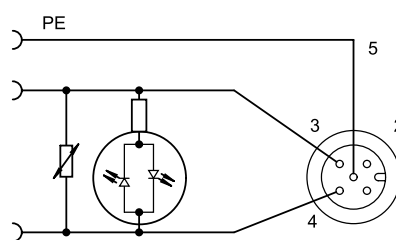

KMEB without signal status indication

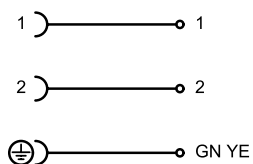

- For KMEB-3
- No gn/ye connection
- Operating voltage 24 V DC

KMEB-2 with signal status indication

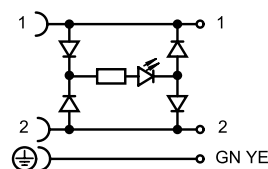

Data sheet

★ Core product range

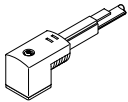

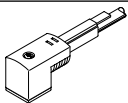
Ordering data							
	Signal status indication	Material Cable sheath	Operating voltage [V]	Cable length [m]	Weight [g]	Part no.	Type
KMEB-1							
	LED	PVC	24 DC	2.5	125	★ 151688	KMEB-1-24-2.5-LED

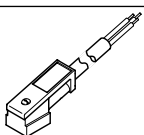
Ordering data							
	Signal status indication	Material Cable sheath	Operating voltage [V]	Cable length [m]	Weight [g]	Part no.	Type
KMEB-1							
	LED	PVC	24 DC	5	230	151689	KMEB-1-24-5-LED
				10	460	193457	KMEB-1-24-10-LED
	–	PVC	230 AC	2.5	125	151690	KMEB-1-230AC-2.5
				5	230	151691	KMEB-1-230AC-5

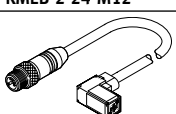
Ordering data							
	Signal status indication	Material Cable sheath	Operating voltage [V]	Cable length [m]	Weight [g]	Part no.	Type
KMEB-2							
	LED	TPE-U(PUR)	24 DC	2.5	200	174844	KMEB-2-24-2.5-LED
				5	400	174845	KMEB-2-24-5-LED
	–	TPE-U(PUR)	230 AC	2.5	200	174846	KMEB-2-230-2.5
				5	400	174847	KMEB-2-230-5

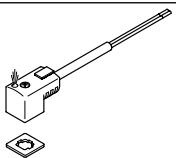
Ordering data							
	Signal status indication	Material Cable sheath	Operating voltage [V]	Cable length [m]	Weight [g]	Part no.	Type
KMEB-2-24-M12							
	LED	TPE-U (PU)	24 DC	0.5	–	177677	KMEB-2-24-M12-0.5-LED

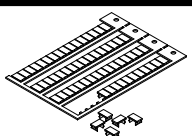
Ordering data							
	Signal status indication	Material Cable sheath	Operating voltage [V]	Cable length [m]	Weight [g]	Part no.	Type
KMEB-3							
	Yellow LED	PVC	24 DC	2.5	120	547268	KMEB-3-24-2.5-LED
				5	230	547269	KMEB-3-24-5-LED
	–	PVC	24 DC	2.5	120	547270	KMEB-3-24-2.5
				5	230	547271	KMEB-3-24-5

Ordering data – Accessories				
	Description	Use	Part no.	Type
	Inscription labels 6x10 mm, 64 pieces, in frame	KMEB-3	18576	IBS-6x10
	Inscription labels 9x20 mm, 20 pieces, in frame	KMEB-2	18182	IBS-9x20
	Inscription label holders for identifying connecting cables	For cable diameter 4.2 ... 5.6 mm	8143238	NEAU-LH-4