

Solenoid/pneumatic valves, ISO 15407-1

FESTO

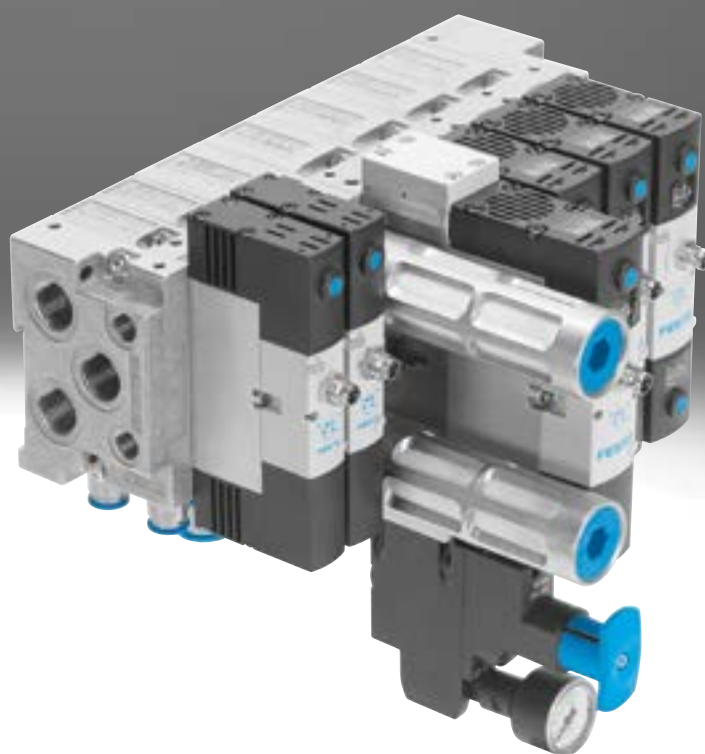

Key features

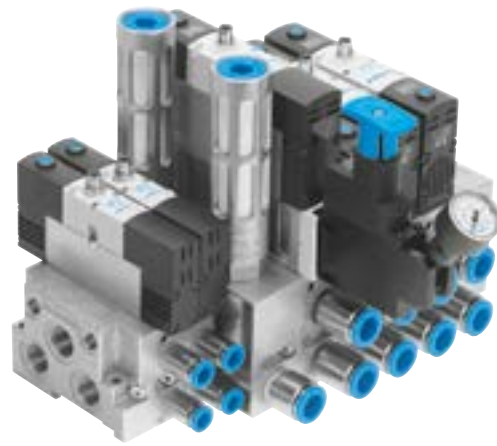
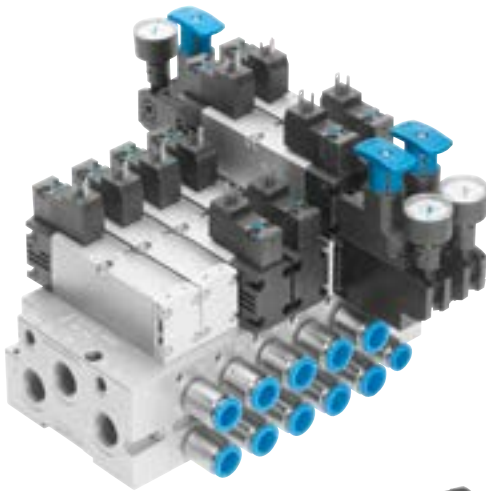

Innovative

- High-performance valves in a sturdy metal housing
- Individual electrical connection via square or round plug sockets
- Valves can be replaced under pressure using a vertical pressure shut-off plate
- Reverse operation
- Vacuum operation

Flexible

- Modular system offering a range of configuration options
- Conversions and extensions are possible at any time
- Innovative functional modules can be integrated
 - Regulator plate
 - Throttle plate
 - Vertical pressure shut-off plate
 - Vertical supply plate
- Vertical supply plates permit a flexible air supply and variable pressure zones
- Wide range of valve functions
- Extensive operating voltage range from 12 V DC to 230 V AC

Reliable

- Sturdy and durable metal components
 - Valves
 - Horizontally linked sub-bases
 - Vertically stacked sub-bases
- Fast troubleshooting thanks to LEDs:
 - in the plug socket, or
 - in the illuminating seal, or
 - in the valve
- Reliable servicing thanks to valves that can be replaced quickly and easily
- Manual override
- Durable thanks to tried-and-tested piston spool valves

Easy to install

- Secure mounting on a wall or H-rail
- Combinations of manifold assemblies of valve size 18 mm and 26 mm
- Plug-in pressure gauges on the regulator plate

Key features

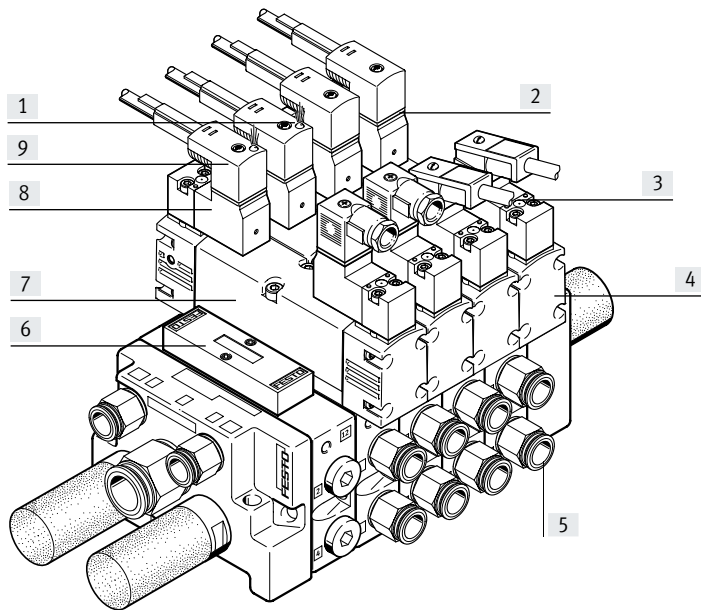
Single valve manifold assembly
VTIA

- [1] Signal status indication via LED
- [2] Signal status indication via illuminating seal
- [3] Manual override
- [4] One valve series for different flow rates
- [5] Fittings with external hex
- [6] Cover plate for vacant and expansion positions
- [7] Various valve functions
- [8] Various voltages
- [9] Pilot valve with port pattern to ISO 15218

Equipment options

5/2-way valve

- Single solenoid, pneumatic or spring return
- Double solenoid valve
- Double solenoid valve with dominance at 14

2x 3/2-way valve, single solenoid

- Normally open
- Normally open, reversible (on request)
- Normally closed
- Normally closed, reversible (on request)

- 1x normally open, 1x normally closed
- 1x normally open, 1x normally closed, reversible (on request)

5/3-way valve

- Mid-position valve
 - Normally open
 - Normally closed
 - Normally exhausted

2x 2/2-way valve, single solenoid

- Normally closed

Special features

Operation with external pilot air supply

- For vacuum applications
- For operating pressure of less than 0.3 MPa
- For significant pressure fluctuations in the power section. Power unit and pneumatic control unit are isolated
- For heavily lubricated air in the power unit
- For manifolds if the pressure zones are created via ducts 3 and 5 (not possible with 2x 3/2)
- For manifolds or pressure zones that are equipped with reversible 2x 3/2-way valves (valves on request)

Operation with internal pilot air supply

- For small pressure fluctuations in the power section
- For using regulator plates with vertical stacking, also in reverse operation
- As a low-cost solution

Reverse operation with compressed air supply via ducts 3 and 5

- Pressure zone separation via ducts 3 and 5
 - Example: duct 3 vacuum, duct 5 ejector pulse
 - Example: duct 3 high pressure for advancing the piston rod of a double-acting cylinder. Low pressure at duct 5 for retracting the piston rod with low energy consumption
- 2x 3/2-way valves used as 5/4-way valve with controllable overlap and pressure zone separation with the reversible variant

Reverse operation with a regulator plate, compressed air supply via duct 1

- Reversible pressure regulator combined with a reversible 2x 3/2-way valve regulates outputs 2 and 4
 - AB regulator for each of outputs 2 and 4
 - A regulator for output 4
 - B regulator for output 2
- Reversible pressure regulators are in the control position immediately after the power supply is switched on
 - Adjustment possible at all times
 - Dynamic response characteristics
 - Reduced regulator load because the supply pressure is maintained when the valve is switched
 - Not exhausted via the regulator

Key features

Valve manifold assembly VTIA with a combination of sizes and vertical stacking

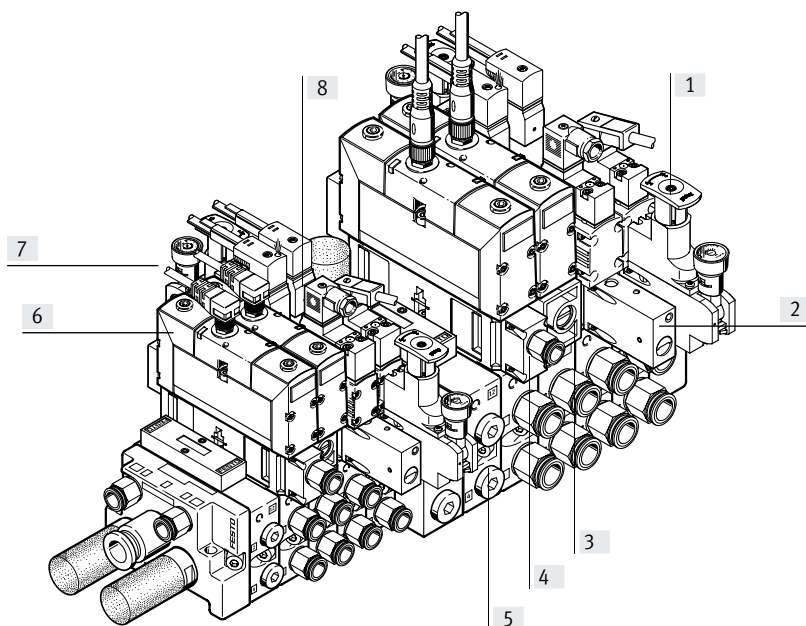

- [1] Pressure regulator for adjusting the force of the actuated drive
- [2] Pressure shut-off plate for replacing valves during operation
- [3] Throttle plate for adjusting the speed of the drive
- [4] Supply plate for compressed air supply of a control chain as a separate pressure zone
- [5] Intermediate plate as interface between valve size 18 mm and 26 mm
- [6] Solenoid valve with central round plug
- [7] Valve size 18 mm and 26 mm in combination
- [8] Solenoid valve with individual pilot valves and port pattern to ISO 15218, can be connected using square plug sockets or round plug

Vertical stacking function

Pressure regulator

- Single variant to regulate the pressure at output 4(A) or 2(B) or at input 1(P)
- Dual variant to regulate the pressure at output 4(A) and 2(B) individually
- Reverse variant for the outputs so that the regulator is in the control position
- With pressure gauge connection

Throttle plate

- Designed with two flow control valves for adjusting the exhaust air flow rate at exhausts 5 or 3. This allows the drive to be set in motion and the required speed to be set at the manifold using the manual override.

Vertical pressure shut-off plate

- Equipped with a switch via which the compressed air supply can be shut off. A directional control valve or downstream vertical stacking plate can thus be replaced without switching off the overall air supply.
- If the control chain has a redundant design, the cycle can continue even with cyclical control.

Vertical supply plate

- As additional air supply for a valve
- To supply a third pressure zone

Individual connection with square plug, type C

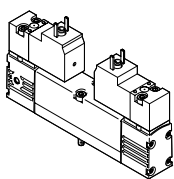

The directional control valve has a pilot control to ISO 15218 and a plug pattern to EN 175301-803, type C.

Individual connection with square plug, with position sensing

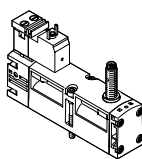

The directional control valve has a pilot control to ISO 15218, a plug pattern to EN 175301-803, type C and an inductive sensor.

Individual connection with square plug, type B

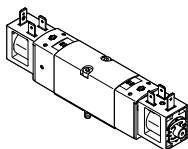

The electrical connection is established using a plug socket with plug pattern type C to industry standard.

Individual connection with central round plug

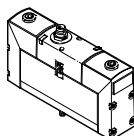

The electrical connection is established using a standardised M12 or M8 plug socket 24 V DC (EN 61076-2-101).

Key features

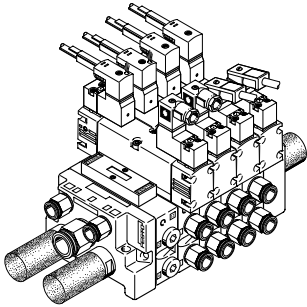
Single valve manifold assembly VTIA, directional control valves with square plug, type C

- Valve size 26 mm
- Spare position
- Compressed air supply via duct 1
- External pilot air supply
- With fittings
- Exhausting via silencer for ducts 3 and 5

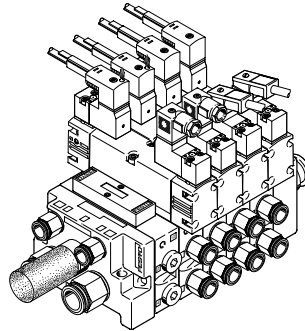
Single valve manifold assembly VTIA, pressure zones via duct 3 and 5

- Valve size 26 mm
- Spare position
- Compressed air supply via ducts 3 and 5
- External pilot air supply
- With fittings
- Exhausting via silencer

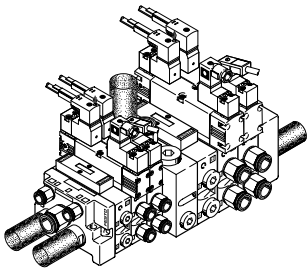
Valve manifold assembly VTIA fitted with valve size 18 mm and 26 mm, directional control valves with square plug, type C

- Valve sizes 18 mm and 26 mm combined via intermediate plate
- Spare position
- Compressed air supply via duct 1
- External pilot air supply
- With fittings
- Exhausting via silencer for ducts 3 and 5 on the end plates and for duct 3 also on the intermediate plate

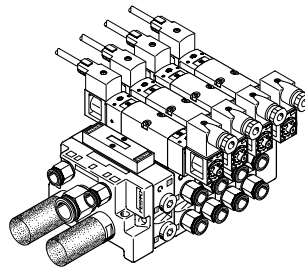
Valve manifold assembly VTIA fitted with valve size 26 mm, directional control valves with square plug, type B

- Valve size 26 mm
- Spare position
- Compressed air supply via duct 1
- Internal pilot air supply
- With fittings
- Exhausting via silencer for ducts 3 and 5
- No regulator plates possible

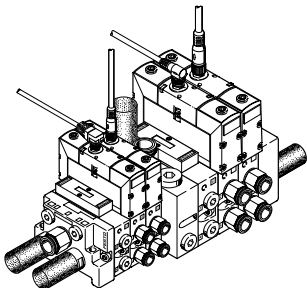
Valve manifold assembly VTIA fitted with valve size 18 mm and 26 mm, directional control valves with central round plug

- Valve sizes 18 mm and 26 mm combined via intermediate plate
- Spare position
- Compressed air supply via duct 1
- Internal pilot air supply
- With fittings
- Exhausting via silencer for ducts 3 and 5 on the end plates and for duct 3 also on the intermediate plate

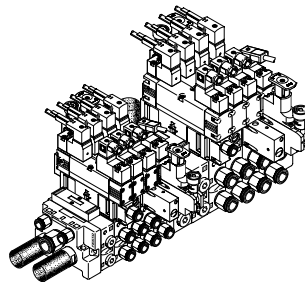
Valve manifold assembly VTIA with maximum expansion using vertical stacking modules

- Valve sizes 18 mm and 26 mm combined via intermediate plate
- Directional control valves with square plug
- Pressure regulators
- Throttle plates
- Shut-off plates
- Supply plates with vacant position

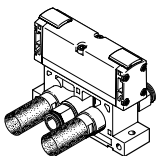
Pneumatically actuated directional control valve on individual sub-base

Directional control valves on an individual sub-base can be used for drives that are further away from a valve manifold assembly or when there is only one drive.

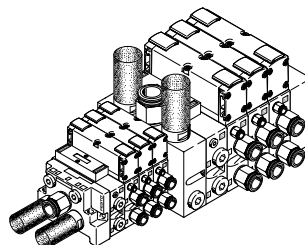
Valve manifold assembly VTIA with valve size 18 mm and 26 mm, with pneumatically actuated directional control valves

- Valve sizes 18 mm and 26 mm combined via intermediate plate
- Spare position
- Compressed air supply via duct 1
- With fittings
- Exhausting via silencer for ducts 3 and 5 on the end plates and for ducts 3 and 5 also on the intermediate plate

Key features

Solenoid valves with square plug, type C

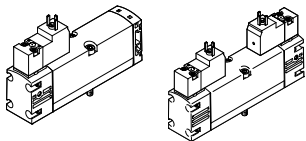

- Valve size 18 mm and 26 mm
- 2x 2/2-way, 2x 3/2-way, 5/2-way and 5/3-way valves
- 2x 3/2-way valves for reverse operation
- Internal or external pilot air supply available
- 12, 24 V DC, 24, 110 or 220 V AC

Solenoid valves with M12 round plug

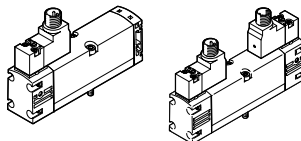

- Valve size 18 mm and 26 mm
- 2x 2/2-way, 2x 3/2-way, 5/2-way and 5/3-way valves
- 2x 3/2-way valves for reverse operation
- Internal or external pilot air supply available
- 24 V DC

Basic valves with interface to ISO 15218

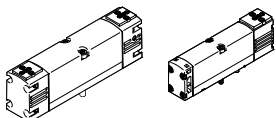

- Valve size 18 mm and 26 mm
- 2x 2/2-way, 2x 3/2-way, 5/2-way and 5/3-way valves
- Internal or external pilot air supply available

Pilot valve with interface to ISO 15218

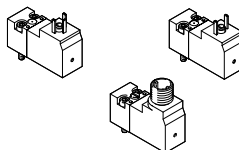

- With square plug, type C or M12 round plug
- For 12, 24 V DC and 24 V AC without PE conductor
- For 110 and 220 V AC with PE conductor
- 3/2-way valve
- Non-detenting or non-detenting/detenting manual override

Valve with position sensing

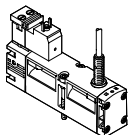

- Valve size 26 mm
- 5/2-way valves
- Internal or external pilot air supply available
- 24 V DC
- Inductive sensor for monitoring the normal position of the piston spool valve

Solenoid valves with square plug, type B

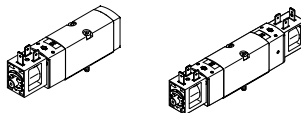

- Valve size 26 mm
- 5/2- and 5/3-way valves
- Internal pilot air supply
- 24 V DC

Solenoid valves with central round plug

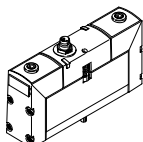

- Valve size 18 mm and 26 mm
- 2x 3/2-way, 5/2-way and 5/3-way valves
- Internal or external pilot air supply available
- 24 V DC

Pneumatically actuated directional control valves

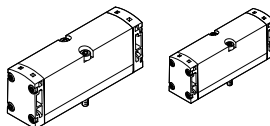

- Valve size 18 mm and 26 mm
- 2x 3/2-way, 5/2-way and 5/3-way valves
- Signal inputs 12 and 14 via the sub-base

Individual sub-base

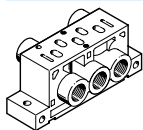

- Valve size 18 mm and 26 mm
- Ports 12 and 14 for external pilot air supply for solenoid valves and
- Ports signal inputs 12 and 14 for pneumatically actuated valves are the same

Cover plate for vacant position

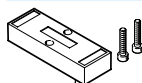

- Valve size 18 mm and 26 mm

End plate kit

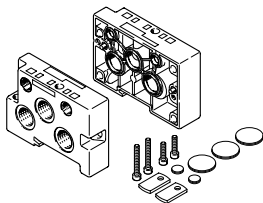

- Valve size 18 mm and 26 mm
- Ports 12 and 14 for external pilot air supply for solenoid valves
- The signal inputs for pneumatically actuated valves are only on suitable manifold sub-bases

Manifold sub-base/series sub-base

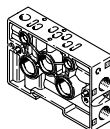

- Valve size 18 mm and 26 mm
- For solenoid valves
- For pneumatically actuated valves with additional ports for the signal inputs

Key features

Intermediate plate

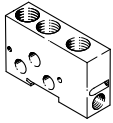

- Adapter between valve size 18 mm and 26 mm
- With additional air supply and exhaust ports

Intermediate plate kit

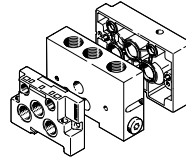

- Intermediate plate as adapter between valve sizes 18 mm and 26 mm
- One 18 mm and one 26 mm end plate

Pressure regulator plate with one pressure regulator

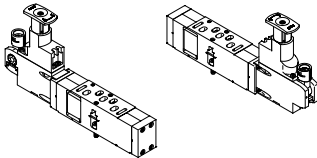

Variants

- Valve size 18 mm and 26 mm
- For pressure regulation at supply input 1 (P). Set pressure is the same for ports 2 and 4
- For pressure regulation at working port 4 (A)
 - The pressure regulator for reverse operation is supplied via port 1 of the sub-base and supplies port 5 on the directional control valve
 - The directional control valve exhausts via port 1 to ports 3 and 5 of the sub-base
- For pressure regulation at working port 2 (B)
 - Input 3 is supplied here in reverse operation

Regulator plate with 2 pressure regulators

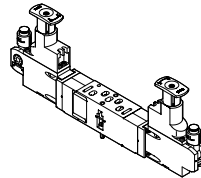

Variants

- Valve size 18 mm and 26 mm
- For pressure regulation at working ports 4 (A) and 2 (B)
 - The pressure regulators for reverse operation are supplied via port 1 in the sub-base and feed inputs 5 and 3 on the directional control valve
 - The directional control valve exhausts via port 1 to ports 3 and 5 of the sub-base

Vertical supply plate

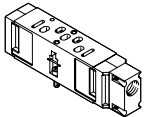

Variants

- Valve size 18 mm and 26 mm
- As intermediate supply
 - For one valve
 - To supply a third pressure zone
- Can be equipped with a directional control valve

Throttle plate

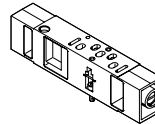

Variants

- Valve size 18 mm and 26 mm
- Exhaust air restrictors in ducts 3 and 5
 - The flow control plates act as supply air flow control valves for pressure zones that are created via ducts 3 and 5

Vertical pressure shut-off plate

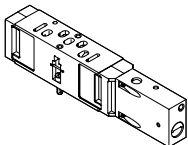

Variants

- Valve size 18 mm and 26 mm
- A switch activated with a slotted head screwdriver shuts off duct 1
 - The throttle plates, pressure regulator plates or directional control valves above it can be replaced
 - Other components of the control chain such as drives, for example, can be replaced once they have been exhausted via the directional control valve

Pressure gauge



Design

- Can be connected to the regulator plates

Key features

Port pattern on sub-base to ISO 15407-1

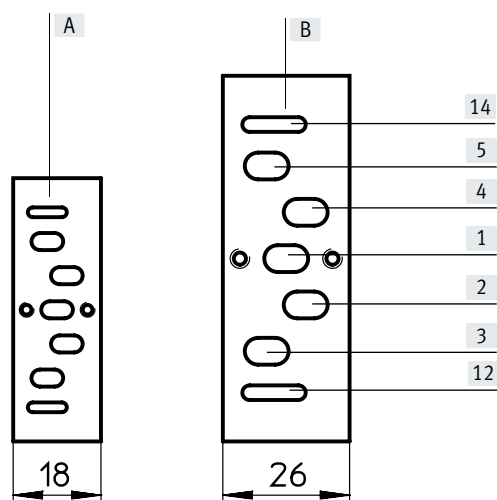

- [A] Valve size 18 mm
- [B] Valve size 26 mm

VSVA

Conversion of pilot air exhaust

The valve manifold assembly VTIA is supplied with unducted pilot air exhaust. By turning the seal between the

valve and manifold block, exhaust air (pilot air) can be diverted to pilot duct

12 and can thus be ducted and silenced (see illustration).

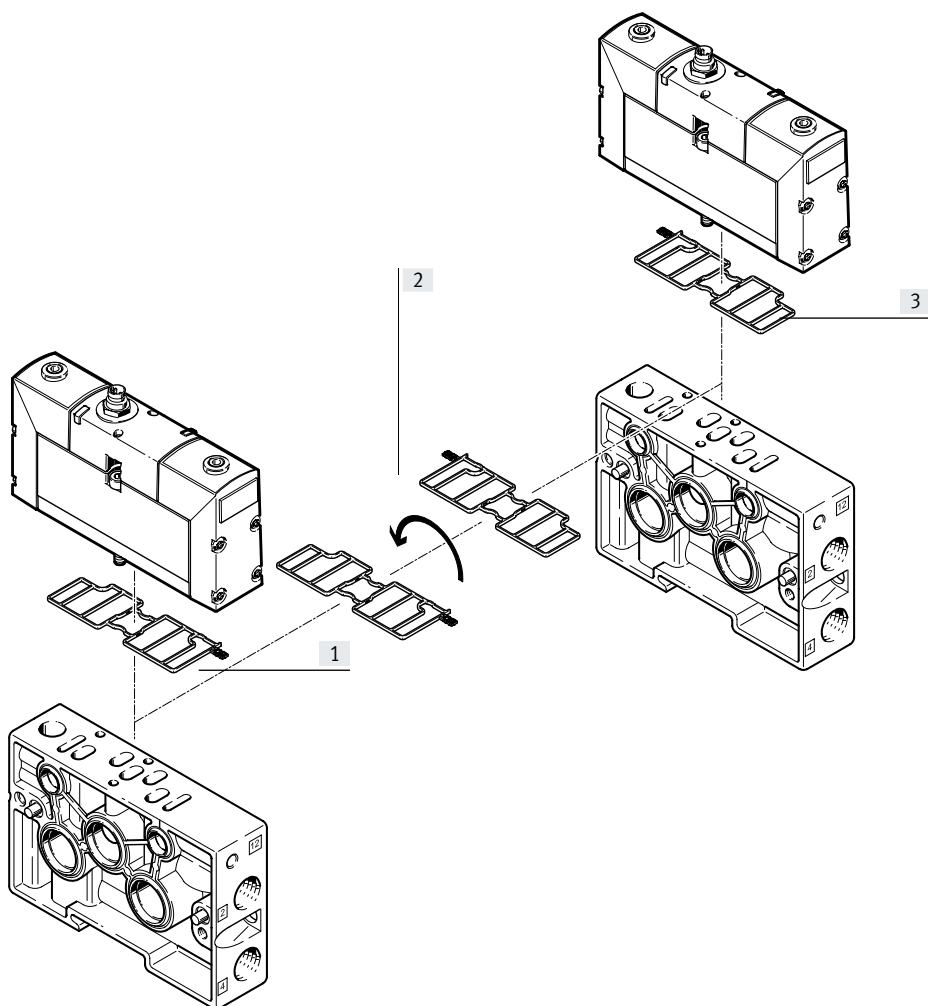





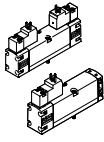

- [1] Ducted pilot air exhaust
- [2] Turning the seal 180°
- [3] Unducted pilot air exhaust (as supplied)

Key features

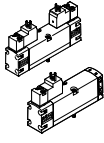
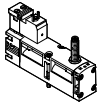
Use of 2x 3/2-way valve as 5/4-way valve																			
Code	Circuit symbol	Table of values	Equivalent circuit symbol	Function															
K		<table border="1"> <thead> <tr> <th>Y1</th> <th>Y2</th> <th>A</th> </tr> </thead> <tbody> <tr> <td>0</td> <td>0</td> <td></td> </tr> <tr> <td>0</td> <td>1</td> <td></td> </tr> <tr> <td>1</td> <td>0</td> <td></td> </tr> <tr> <td>1</td> <td>1</td> <td></td> </tr> </tbody> </table>	Y1	Y2	A	0	0		0	1		1	0		1	1			<ul style="list-style-type: none"> • Normally exhausted • The double-acting drive connected to outputs 2 and 4 is unpressurised when the valve is in the normal position and can be moved by an external force • If there is a signal at Y1(14) and Y2(12), there is pressure at outputs 2 and 4
Y1	Y2	A																	
0	0																		
0	1																		
1	0																		
1	1																		
		<table border="1"> <thead> <tr> <th>Y1</th> <th>Y2</th> <th>A</th> </tr> </thead> <tbody> <tr> <td>0</td> <td>0</td> <td></td> </tr> <tr> <td>0</td> <td>1</td> <td></td> </tr> <tr> <td>1</td> <td>0</td> <td></td> </tr> <tr> <td>1</td> <td>1</td> <td></td> </tr> </tbody> </table>	Y1	Y2	A	0	0		0	1		1	0		1	1			<ul style="list-style-type: none"> • Normally closed (by combining directional control valve code K and two piloted check valves) • The piloted check valves connected to outputs 2 and 4 are unpressurised when the valve is in the normal position and the pressures in the drive close the check valves so it is leak-tight • The drive remains stationary when the forces are in equilibrium • Leakages can only occur via the drive seals • If there is a signal at Y1(14) and Y2(12), the same pressure is present at outputs 2 and 4
Y1	Y2	A																	
0	0																		
0	1																		
1	0																		
1	1																		
N		<table border="1"> <thead> <tr> <th>Y1</th> <th>Y2</th> <th>A</th> </tr> </thead> <tbody> <tr> <td>0</td> <td>0</td> <td></td> </tr> <tr> <td>0</td> <td>1</td> <td></td> </tr> <tr> <td>1</td> <td>0</td> <td></td> </tr> <tr> <td>1</td> <td>1</td> <td></td> </tr> </tbody> </table>	Y1	Y2	A	0	0		0	1		1	0		1	1			<ul style="list-style-type: none"> • Normally open • The double-acting drive connected to outputs 2 and 4 is supplied with the same compressed air at both ends when the valve is in the normal position and stops when the forces are in equilibrium • If there is a signal at Y1(10) and Y2(10), outputs 2 and 4 are exhausted, the drive is unpressurised and can be moved by an external force
Y1	Y2	A																	
0	0																		
0	1																		
1	0																		
1	1																		
H		<table border="1"> <thead> <tr> <th>Y1</th> <th>Y2</th> <th>A</th> </tr> </thead> <tbody> <tr> <td>0</td> <td>0</td> <td></td> </tr> <tr> <td>0</td> <td>1</td> <td></td> </tr> <tr> <td>1</td> <td>0</td> <td></td> </tr> <tr> <td>1</td> <td>1</td> <td></td> </tr> </tbody> </table>	Y1	Y2	A	0	0		0	1		1	0		1	1			<ul style="list-style-type: none"> • Normally open after output 2 • The double-acting drive connected to outputs 2 and 4 is supplied with compressed air via output 2 when the valve is in the normal position. Port 4 is exhausted. When the system is in its initial position, the drive is thus in a clearly defined position, as would also be the case with a 5/2-way single solenoid valve • If there is a signal at Y1(14) and Y2(10), output 2 is exhausted and there is pressure at output 4. The drive leaves the initial position • A closed circuit can be created with this 2x 3/2-way valve by combining it with piloted non-return valves. However, this is then selected by an active signal at Y2(10).
Y1	Y2	A																	
0	0																		
0	1																		
1	0																		
1	1																		

Product range overview

Function	Type	Valve function	Flow rate Valve [l/min]	Working port on the sub-base		Operating voltage					
				G1/8	G1/4	[V DC]		[V AC]			
						12	24	24	110	230	
Valve size 18 mm	Valve with pilot interface to ISO 15218										
		VSVA-B-T32...A2	2x 2/2-way valve, single solenoid	700	■	–	■	■	■	■	■
		VSVA-B-T32...A2	2x 3/2-way valve, single solenoid	600	■	–	■	■	■	■	■
		VSVA-B-M52...A2	5/2-way valve, single solenoid	750	■	–	■	■	■	■	■
		VSVA-B-B52...A2	5/2-way valve, double solenoid	750	■	–	■	■	■	■	■
		VSVA-B-P53...A2	5/3-way valve, mid-position valve	650	■	–	■	■	■	■	■
	Valve with central plug										
		VSVA-B-T32...A2	2x 3/2-way valve, single solenoid	600	■	–	–	■	–	–	–
		VSVA-B-M52...A2	5/2-way valve, single solenoid	750	■	–	–	■	–	–	–
		VSVA-B-B52...A2	5/2-way valve, double solenoid	750	■	–	–	■	–	–	–
		VSVA-B-P53...A2	5/3-way valve, mid-position valve	650	■	–	–	■	–	–	–
	Pneumatic valve										
		VSPA-B-T32...A2	2x 3/2-way valve, single solenoid	550	■	–	–	–	–	–	–
		VSPA-B-M52...A2	5/2-way valve, single solenoid	700	■	–	–	–	–	–	–
		VSPA-B-B52...A2	5/2-way valve, double solenoid	700	■	–	–	–	–	–	–
		VSPA-B-P53...A2	5/3-way valve, mid-position valve	650	■	–	–	–	–	–	–
	Valve size 26 mm	Valve with pilot interface to ISO 15218									
		VSVA-B-T32...A1	2x 2/2-way valve, single solenoid	1350	–	■	■	■	■	■	■
		VSVA-B-T32...A1	2x 3/2-way valve, single solenoid	1250	–	■	■	■	■	■	■
		VSVA-B-M52...A1	5/2-way valve, single solenoid	1400	–	■	■	■	■	■	■
		VSVA-B-B52...A1	5/2-way valve, double solenoid	1400	–	■	■	■	■	■	■
		VSVA-B-P53...A1	5/3-way valve, mid-position valve	1400	–	■	■	■	■	■	■
Valve with pilot interface to ISO 15218, with position detection											
		VSVA-B-M52...A1	5/2-way valve, single solenoid	1400	–	■	–	■	–	–	–
Valve with square plug type B to industry standard											
		VSVA-B-M52...A1	5/2-way valve, single solenoid	915	–	■	–	■	–	–	–
		VSVA-B-B52...A1	5/2-way valve, double solenoid	915	–	■	–	■	–	–	–
		VSVA-B-P53...A1	5/3-way valve, mid-position valve	924	–	■	–	■	–	–	–
Valve with central plug											
		VSVA-B-T32...A1	2x 3/2-way valve, single solenoid	1250	–	■	–	■	–	–	–
		VSVA-B-M52...A1	5/2-way valve, single solenoid	1400	–	■	–	■	–	–	–
		VSVA-B-B52...A1	5/2-way valve, double solenoid	1400	–	■	–	■	–	–	–
		VSVA-B-P53...A1	5/3-way valve, mid-position valve	1400	–	■	–	■	–	–	–
Pneumatic valve											
	VSPA-B-T32...A1	2x 3/2-way valve, monostable	1250	–	■	–	–	–	–	–	
	VSPA-B-M52...A1	5/2-way valve, monostable	1400	–	■	–	–	–	–	–	
	VSPA-B-B52...A1	5/2-way valve, bistable	1400	–	■	–	–	–	–	–	
	VSPA-B-P53...A1	5/3-way valve, mid-position valve	1400	–	■	–	–	–	–	–	

Product range overview

Plug				Pilot air		→ Page/ Internet	
Square		Round plug		Internal	External		
Type C	Type B	M8x1	M12x1				
Valve with pilot interface to ISO 15218							
■		–	■	■	■	Pneumatic spring return, normally closed	21
■		–	■	■	■	Pneumatic spring return, normally closed, open, 1x open/1x closed	21
■		–	■	■	■	Pneumatic or mechanical spring return	21
■		–	■	■	■	Dominance: 1st signal or at 14	21
■		–	■	■	■	Normally closed, exhausted, open	21
Valve with central plug							
–		■	■	■	■	Pneumatic spring return, normally closed, open, 1x open/1x closed	49
–		■	■	■	■	Pneumatic or mechanical spring return	49
–		■	■	■	■	Dominance: 1st signal or at 14	49
–		■	■	■	■	Normally closed, exhausted, open	49
Pneumatic valve							
–		■	■	■	■	Pneumatic spring return, normally closed, open, 1x open/1x closed	49
–		■	■	■	■	Pneumatic or mechanical spring return	49
–		■	■	■	■	Dominance: 1st signal or at 14	49
–		■	■	■	■	Normally closed, exhausted, open	49
Valve with pilot interface to ISO 15218							
■		–	■	■	■	Pneumatic spring return, normally closed	31
■		–	■	■	■	Pneumatic spring return, normally closed, open, 1x open/1x closed	31
■		–	■	■	■	Pneumatic or mechanical spring return	31
■		–	■	■	■	Dominance: 1st signal or at 14	31
■		–	■	■	■	Normally closed, exhausted, open	31
Valve with pilot interface to ISO 15218, with position detection							
■		–	–	–	■	Inductive sensor for monitoring the normal position of the piston spool valve	41
Valve with square plug type B to industry standard							
–	■	–	–	■	–	Pneumatic or mechanical spring return	45
–	■	–	–	■	–	Double solenoid	45
–	■	–	–	■	–	Normally exhausted	45
Valve with central plug							
–		■	■	■	■	Pneumatic spring return, normally closed, open, 1x open/1x closed	54
–		■	■	■	■	Pneumatic or mechanical spring return	54
–		■	■	■	■	Dominance: 1st signal or at 14	54
–		■	■	■	■	Normally closed, exhausted, open	54
Pneumatic valve							
–		■	■	■	■	Pneumatic spring return, normally closed, open, 1x open/1x closed	62
–		■	■	■	■	Pneumatic or mechanical spring return	62
–		■	■	■	■	Dominance: 1st signal or at 14	62
–		■	■	■	■	Normally closed, exhausted, open	62

Type codes

001	Series	
VSVA	Standards-based valve VSVA	
002	Directional control valve type	
B	Sub-base valve	
003	Valve function	
T22C	2x2/2-way valve, normally closed	
T32U	2x3/2-way valve, normally open	
T32F	2x3/2-way valve, normally open, reversible	
T32C	2x3/2-way valve, normally closed	
T32N	2x3/2-way valve, normally closed, reversible	
T32H	2x3/2-way valve, 1x normally closed, 1x normally open	
T32W	2x3/2-way valve, 1x normally closed, 1x normally open, reversible	
B52	5/2-way valve, double solenoid/bistable	
M52	5/2-way valve, single solenoid/monostable	
D52	5/2-way valve, double solenoid/bistable, dominant signal	
P53U	5/3-way valve, mid-position pressurised	
P53E	5/3-way valve, mid-position exhausted	
P53C	5/3-way valve, mid-position closed	
004	Reset method for monostable/single solenoid valves	
	None	
A	Pneumatic spring	
M	Mechanical spring	

005	Pilot air	
	Internal	
Z	External	
006	Manual override	
D	Non-detenting, detenting	
H	Non-detenting	
007	Pneumatic connection	
A2	18 mm (02) ISO 15407-1/-2	
A1	26 mm (01) ISO 15407-1/-2	
D1	42 mm (1) ISO 5599-1/-2	
D2	52 mm (2) ISO 5599-1/-2	
008	Nominal operating voltage	
1	24 V DC	
009	Electrical connection	
R2	Central connector M8	
R5	Central plug M12	
010	Display	
L	LED	

Type codes

001 Series	
VSVA	Standards-based valve VSVA
002 Directional control valve type	
B	Sub-base valve
003 Design principle	
	Piston spool
K	Piston spool with sealing ring
004 Valve function	
T22C	2x2/2-way valve, normally closed
T32U	2x3/2-way valve, normally open
T32F	2x3/2-way valve, normally open, reversible
T32C	2x3/2-way valve, normally closed
T32N	2x3/2-way valve, normally closed, reversible
T32H	2x3/2-way valve, 1x normally closed, 1x normally open
T32W	2x3/2-way valve, 1x normally closed, 1x normally open, reversible
B52	5/2-way valve, double solenoid/bistable
M52	5/2-way valve, single solenoid/monostable
D52	5/2-way valve, double solenoid/bistable, dominant signal
P53U	5/3-way valve, mid-position pressurised
P53E	5/3-way valve, mid-position exhausted
P53C	5/3-way valve, mid-position closed
005 Reset method for monostable/single solenoid valves	
	None
A	Pneumatic spring
M	Mechanical spring
006 Pilot air	
	Internal
Z	External

007 Manual override	
	None
D	Non-detenting, detenting
H	Non-detenting
008 Pneumatic connection	
A2	18 mm (02) ISO 15407-1/-2
A1	26 mm (01) ISO 15407-1/-2
D1	42 mm (1) ISO 5599-1/-2
009 Nominal operating voltage	
	None
1	24 V DC
1A	24 V AC/50-60 Hz
2A	110 V AC/50-60 Hz
3A	230 V AC/50-60 Hz
5	12 V DC
010 Electrical connection	
B2	Connection pattern type B, industry standard
C1	Plug pattern type C, to EN 175301-803
P1	Interface for pilot valve size 15 mm to ISO 15218 (CNOMO)
R3	Individual plug M12, to EN 61076-2-101
011 Position sensing	
	None
APC	Proximity sensor, PNP with open cable ends
APP	Proximity sensor, PNP with M8 plug
APX	Proximity sensor, PNP with cable and plug M12
ANC	Proximity sensor, NPN with open cable end
ANP	Proximity sensor, NPN with plug M8

Type codes

001	Series	
VSPA	Standards-based valve to ISO 15407-1/-2	
002	Directional control valve type	
B	Sub-base valve	
003	Valve function	
T32U	2x3/2-way valve, normally open	
T32C	2x3/2-way valve, normally closed	
T32H	2x3/2-way valve, 1x normally closed, 1x normally open	
M52	5/2-way valve, single solenoid/monostable	
B52	5/2-way valve, double solenoid/bistable	
D52	5/2-way valve, double solenoid/bistable, dominant signal	
P53U	5/3-way valve, mid-position pressurised	
P53E	5/3-way valve, mid-position exhausted	
P53C	5/3-way valve, mid-position closed	

004	Reset method for monostable/single solenoid valves	
	None	
A	Pneumatic spring	
M	Mechanical spring	
005	Pneumatic connection	
A2	18 mm (02) ISO 15407-1/-2	
A1	26 mm (01) ISO 15407-1/-2	

Peripherals overview

Individual mounting

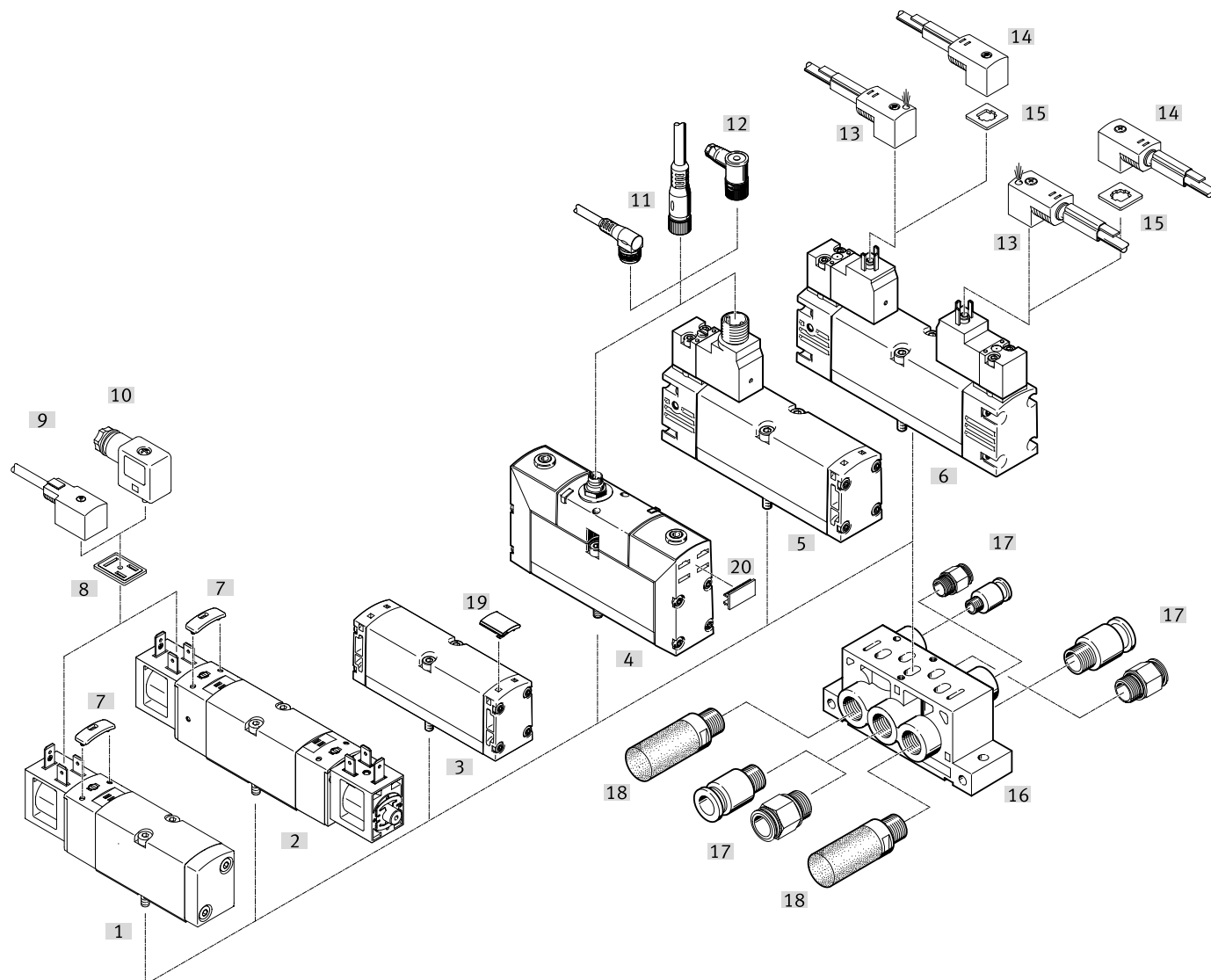

	Type	Brief description	→ Page/Internet	
[1]	Solenoid valve	VSVA-BK...B2	With square plug with plug pattern type B	45
[2]	Solenoid valve	VSVA-BK...B2	With square plug with plug pattern type B	45
[3]	Pneumatic valve	VSPA	Port pattern to ISO 15407-1	59
[4]	Solenoid valve	VSVA-...R	With round plug	49
[5]	Solenoid valve	VSVA-...R3	With interface to ISO 15218 and round plug	21
[6]	Solenoid valve	VSVA-...C	With interface to ISO 15218 and plug pattern type C	21
[7]	Cover cap	VAMC	For manual override, non-detenting or covered	83
[8]	Illuminating seal	MEB-LD	For indicating the signal status, with plug pattern type B	84
[9]	Connecting cable	KMF-1...-LED	With plug pattern type B	84
[10]	Plug socket	MSSD-F	With plug pattern type B	84
[11]	Connecting cable	NEBU	For valves with round plug	84
[12]	Plug socket	SIE-WD-TR	Angled	84
[13]	Connecting cable	KMEB...-LED	With plug pattern type C, with PVC casing and LED	84
[14]	Connecting cable	KMEB	With plug pattern type C, with PVC casing	84
[15]	Illuminating seal	MEB-LD	For indicating the signal status, with plug pattern type C	84
[16]	Individual sub-base	NAS	With lateral ports	71
[17]	Push-in fitting	QS	For standard O.D. tubing	83
[18]	Silencer	U	For fitting in exhaust ports	83
[19]	Inscription label holder	ASCF	For identifying the VSPA pneumatic valves	83
[20]	Inscription label	IBS-9x20	For identifying the VSVA valves with round plug	83

Peripherals overview

Manifold assembly – Solenoid valves

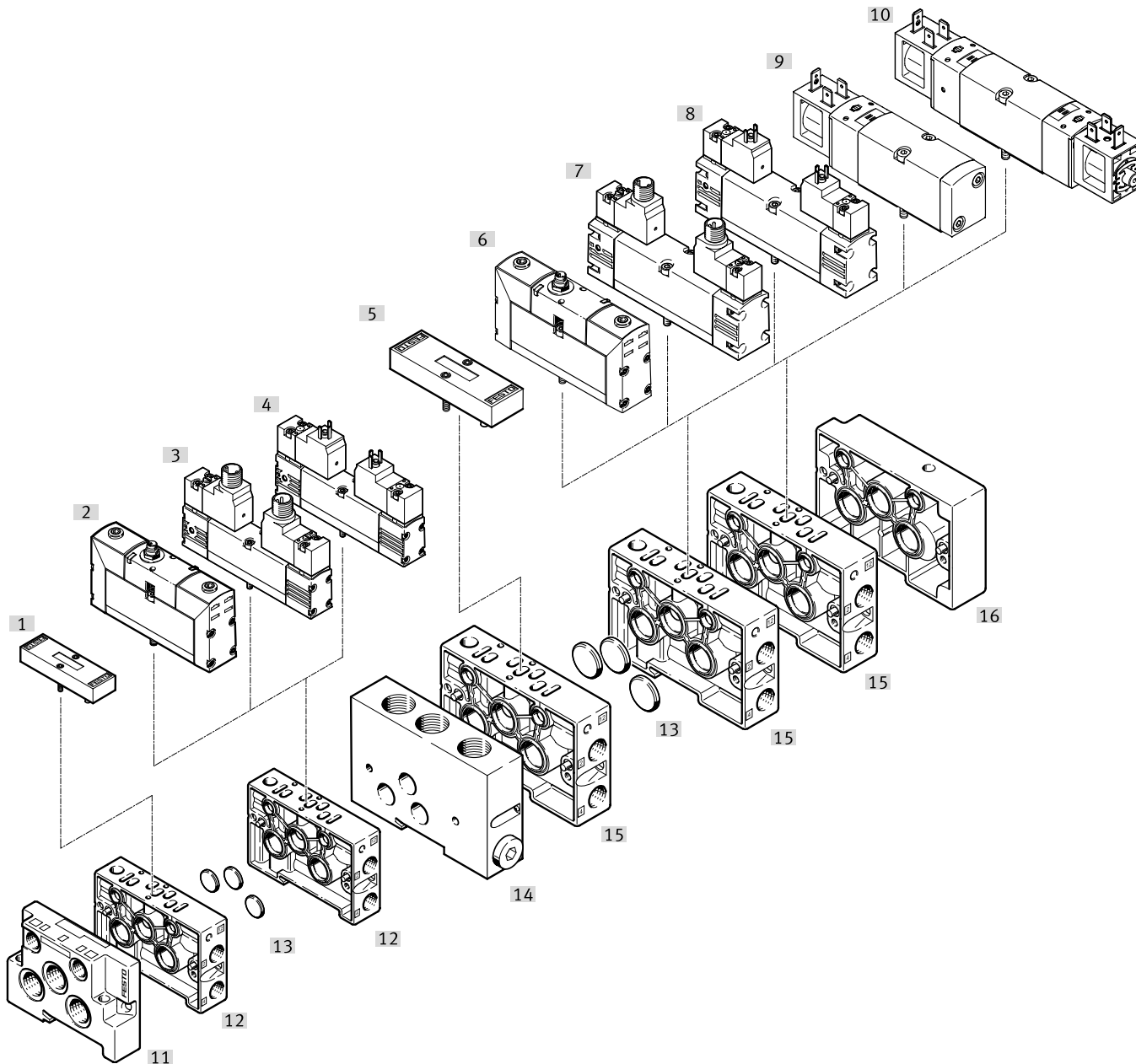

	Type	Brief description	→ Page/Internet	
[1]	Cover plate	NDV-02-VDMA	For valve size 18 mm, vacant or spare position	81
[2]	Solenoid valve	VSVA...A2...R	Valve size 18 mm with round plug	49
[3]	Solenoid valve	VSVA...A2...R3	Valve size 18 mm, interface to ISO 15218 with round plug	21
[4]	Solenoid valve	VSVA...A2...C	Valve size 18 mm, interface to ISO 15218 with plug pattern type C	21
[5]	Cover plate	NDV-01-VDMA	For valve size 26 mm, vacant or spare position	81
[6]	Solenoid valve	VSVA...A1...R	Valve size 26 mm with round plug	54
[7]	Solenoid valve	VSVA...A1...R3	Valve size 26 mm, interface to ISO 15218 with round plug	31
[8]	Solenoid valve	VSVA...A1...C	Valve size 26 mm, interface to ISO 15218 with plug pattern type C	31
[9]	Solenoid valve	VSVA-BK...B2	Valve size 26 mm, with square plug with plug pattern type B	45
[10]	Solenoid valve	VSVA-BK...B2	Valve size 26 mm, with square plug with plug pattern type B	45
[11]	End plate	NEV	For sealing the manifold sub-bases valve size 18 mm	72
[12]	Manifold sub-base	NAW-1/8-02-VDMA	Valve size 18 mm with lateral ports 2 and 4	72
[13]	Isolating disc	NSC	For creating pressure zones or for sealing ports on the end plates	81
[14]	Intermediate plate	NZV-01/02-VDMA	For connecting valve size 18 mm with valve size 26 mm	73
[15]	Manifold sub-base	NAW-1/4-01-VDMA	Valve size 26 mm with lateral ports 2 and 4	72
[16]	End plate	NEV	For sealing the manifold sub-bases valve size 26 mm	72

Peripherals overview

Manifold assembly – Pneumatic valves

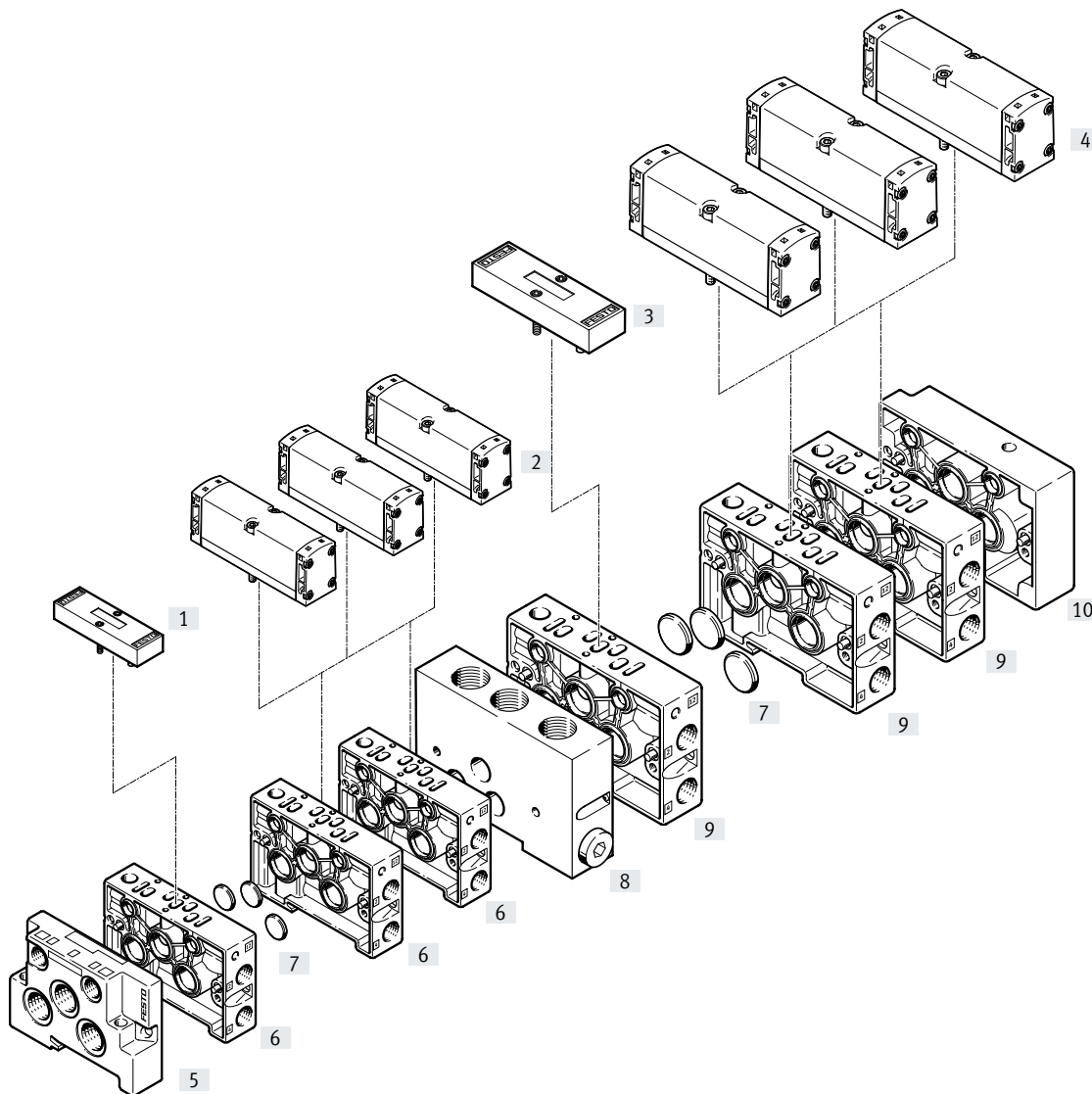

		Type	Brief description	→ Page/Internet
[1]	Cover plate	NDV-02-VDMA	For valve size 18, vacant or spare position	81
[2]	Pneumatic valve	VSPA...A2	Valve size 18	59
[3]	Cover plate	NDV-01-VDMA	For valve size 26, vacant or spare position	81
[4]	Pneumatic valve	VSPA...A1	Valve size 26	62
[5]	End plate	NEV	For sealing the manifold sub-bases valve size 18 mm	72
[6]	Manifold sub-base	NAW-1/8-02-VDMA	Valve size 18 with lateral ports 2 and 4	72
[7]	Isolating disc	NSC	For creating pressure zones or for sealing ports on the end plates	81
[8]	Intermediate plate	NZV-01/02-VDMA	For connecting valve size 18 mm with valve size 26 mm	73
[9]	Manifold sub-base	NAW-1/4-01-VDMA	Valve size 26 with lateral ports 2 and 4	72
[10]	End plate	NEV	For sealing the manifold sub-bases valve size 26 mm	72

Peripherals overview

Manifold assembly with vertical stacking

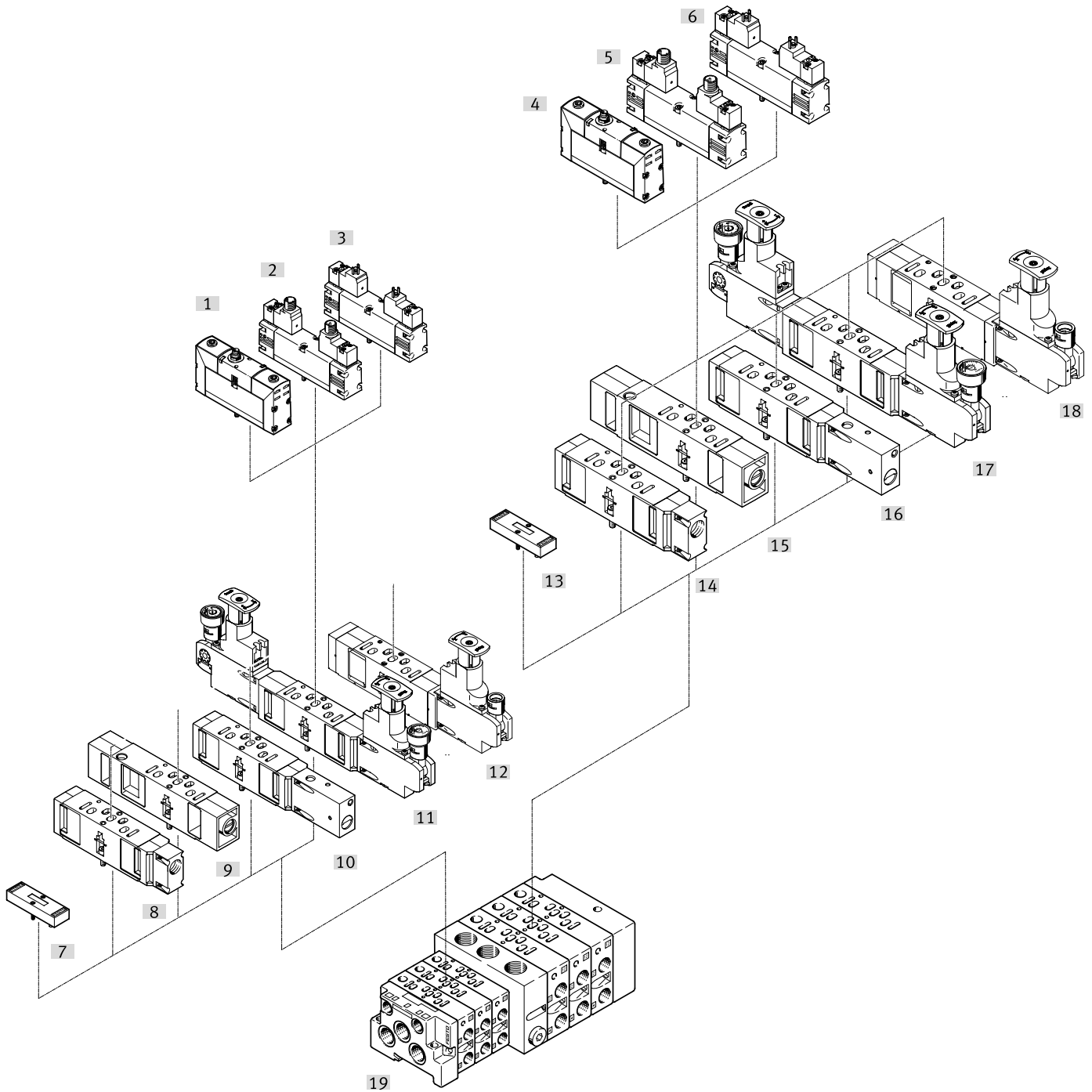

Peripherals overview

	Type	Brief description	→ Page/Internet	
[1]	Solenoid valve	VSVA...A2...R	Valve size 18 mm with round plug	49
[2]	Solenoid valve	VSVA...A2...R3	Valve size 18 mm, interface to ISO 15218 with round plug	21
[3]	Solenoid valve	VSVA...A2...C	Valve size 18 mm, interface to ISO 15218 with plug pattern type C	21
[4]	Solenoid valve	VSVA...A1...R	Valve size 26 mm with round plug	54
[5]	Solenoid valve	VSVA...A1...R3	Valve size 26 mm, interface to ISO 15218 with round plug	31
[6]	Solenoid valve	VSVA...A1...C	Valve size 26 mm, interface to ISO 15218 with plug pattern type C	31
[7]	Cover plate	NDV	Valve size 18 mm, vacant or spare position	81
[8]	Vertical supply plate	VABF...P1-A3	For valve size 18 mm, intermediate air supply	69
[9]	Throttle plate	VABF...F1-B1	For valve size 18 mm, flow control in ducts 3 and 5	68
[10]	Vertical pressure shut-off plate	VABF...L1-D1	For valve size 18 mm, with switch for manually shutting off duct 1	70
[11]	Regulator plate	VABF...R...-C2	For valve size 18 mm, with 2 pressure regulators for working ports 2 and 4	66
[12]	Regulator plate	VABF...R...-C2	For valve size 18 mm, with one pressure regulator for working ports 2 or 4 or for duct 1	66
[13]	Cover plate	NDV	For valve size 26, vacant or spare position	81
[14]	Vertical supply plate	VABF...P1-A3	For valve size 26, intermediate air supply	69
[15]	Throttle plate	VABF...F1-B1	For valve size 26, flow control in ducts 3 and 5	68
[16]	Vertical pressure shut-off plate	VABF...L1-D1	For valve size 26, with switch for manually shutting off duct 1	70
[17]	Regulator plate	VABF...R...-C2	For valve size 26, with 2 pressure regulators for working ports 2 and 4	66
[18]	Regulator plate	VABF...R...-C2	For valve size 26, with one pressure regulator for working ports 2 or 4 or for duct 1	66
[19]	Valve manifold assembly	VTIA	Combination of manifold sub-bases, isolating disc, intermediate plate, end plates	–

Peripherals overview

Manifold assembly

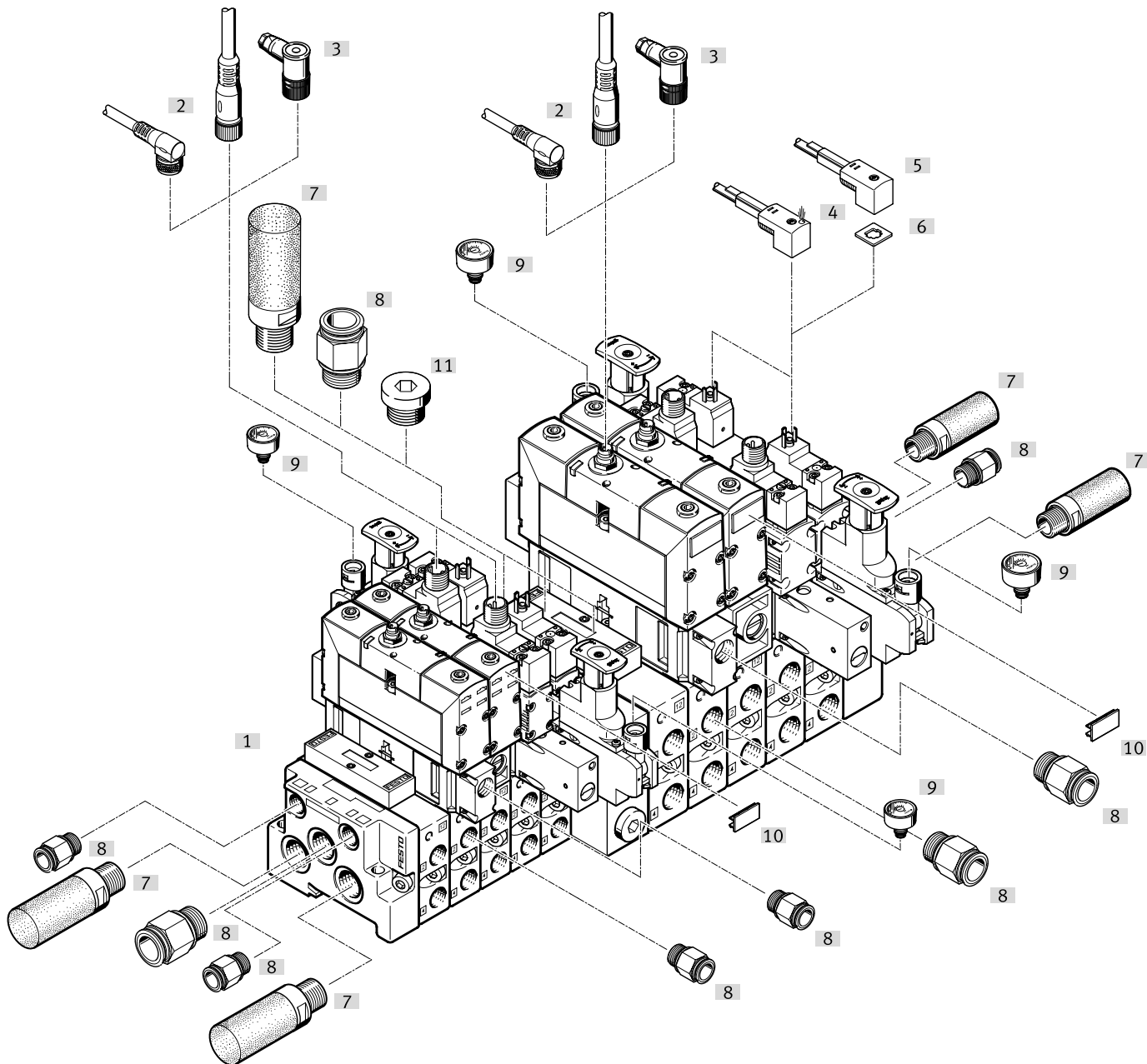

	Type	Brief description	→ Page/Internet	
[1]	Valve manifold assembly	VTIA	Combination of manifold sub-bases, isolating disc, intermediate plate, end plates	–
[2]	Connecting cable	NEBU	For valves with round plug	84
[3]	Plug socket	SIE-WD-TR	Angled	84
[4]	Connecting cable	KMEB...-LED	With PVC casing and LED	84
[5]	Connecting cable	KMEB	With PVC casing	84
[6]	Illuminating seal	MEB-LD	For indicating the signal status	84
[7]	Silencer	U	For fitting in exhaust ports	83
[8]	Push-in fitting	QS	For standard O.D. tubing	83
[9]	Pressure gauge	PAGN-26-10-P10	Can be connected to the pressure regulator plate	83
[10]	Inscription label	IBS-9x20	For identifying the VSVA valves with round plug	83
[11]	Blanking plug	B	For sealing ports that are not required	83

Datasheet – Valve size 18 mm

-  - Flow rate
max. 750 l/min

-  - Voltage
12, 24 V DC
24, 110, 230 V AC

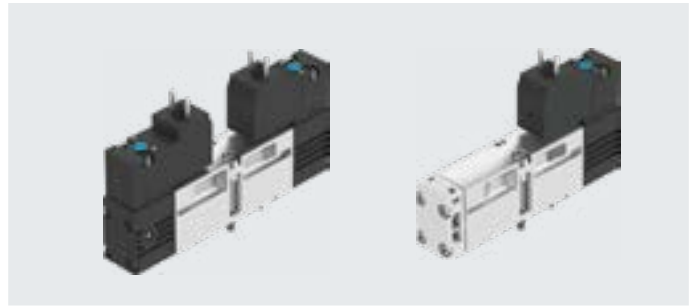

General technical data		2x 2/2-way valve	2x 3/2-way valve	5/2-way valve	5/3-way valve		
Valve function		C ¹⁾	C ¹⁾ , U ²⁾ , H ⁴⁾ , N ⁵⁾ , F ⁶⁾ , W ⁷⁾	–	–	C ¹⁾ , U ²⁾ , E ³⁾	
Normal position		Monostable	Monostable	Monostable	Bistable	Monostable	
Stable position		Yes	Yes	Yes	–	No	
Pneumatic spring return		No	No	Yes	–	Yes	
Mechanical spring return		Piston spool					
Design		Positive overlap					
Overlap		Soft					
Sealing principle		Electrical					
Actuation type		Piloted					
Type of control		To ISO 15218					
Pilot interface		Internal or external					
Pilot air supply		Not ducted as per standard, or ducted					
Pilot air supply, exhaust air		Not reversible or reversible	Not reversible or only reversible	Reversible with external pilot air supply			
Flow direction		Can be throttled					
Exhaust air function		Non-detenting, non-detenting/detenting					
Manual override		On sub-base					
Type of mounting		Any					
Mounting position		5					
Nominal size	[mm]	18					
Valve size	[mm]	G1/8					
Ports on the sub-base	1, 2, 3, 4, 5 12, 14	M5					
Tightening torque for valve mounting	[Nm]	0.9 ... 1.1					
Product weight	Without pilot valve	[g]	98	98	89	98	98
	Solenoid valve	[g]	174	174	127	174	174
Noise level	[dB (A)]	85					
Conforms to		ISO 15407-1, VDMA 24563 and for pilot valve interface ISO 15218					

- 1) C = Normally closed
- 2) U = Normally open
- 3) E = Normally exhausted
- 4) H=2x 3/2-way valve in one housing with 1x normally closed and 1x normally open
- 5) N=Normally closed, reverse operation, i.e. the pressure supply ports are 3 and 5, exhausting is via port 1
- 6) F=Normally open, reverse operation, i.e. the pressure supply ports are 3 and 5, exhausting is via port 1
- 7) W=2x 3/2-way valve in one housing with 1x normally closed and 1x normally open, reverse operation, i.e. the pressure supply ports are 3 and 5, exhausting is via port 1

Flow rates		2x 2/2-way valve	2x 3/2-way valve	5/2-way valve	5/3-way valve
Valve function					
Flow rate of valve	[l/min]	700	600	750	650
Flow rate of valve on individual sub-base	[l/min]	450	450	550	500
Flow rate of pneumatically linked valve	[l/min]	500	400	550	450
Standard nominal flow rate	[l/min]	500	400	550	450

Datasheet – Valve size 18 mm

Switching times [ms]		Switching time on	Switching time off	Switching time changeover	Switching time changeover (dominant)
2x 2/2-way valve		13	21	–	–
2x 3/2-way valve		13	21	–	–
2x 3/2-way valve, reversible		21	13	–	–
5/2-way valve	Pneumatic spring	21	19	–	–
	Mechanical spring	17	35	–	–
5/2-way valve, double solenoid		–	–	18	25
5/3-way valve		18	30	20	–

Safety data					
Type		VSVA-...-1C1	VSVA-...-P1	VSVA-...-5C1 VSVA-...-1AC1	VSVA-...-2AC1 VSVA-...-3AC1
Max. positive test pulse with logic 0	[µs]	1800	–	–	–
Max. negative test pulse with logic 1	[µs]	800	–	–	–
Shock resistance		Shock test with severity level 2 in accordance with FN 942017-5 and EN 60068-2-27			
Vibration resistance		Transport application test with severity level 2 to FN 942017-4 and EN 60068-2-6			

Operating and environmental conditions					
Type		VSVA-...-1C1	VSVA-...-P1	VSVA-...-5C1 VSVA-...-1AC1	VSVA-...-2AC1 VSVA-...-3AC1
Operating medium		Compressed air to ISO 8573-1:2010 [7:4:4]			
Pilot medium		Compressed air to ISO 8573-1:2010 [7:4:4]			
Note on the operating/pilot medium		Lubricated operation possible (in which case lubricated operation will always be required)			
Ambient temperature	[°C]	–5 ... +50			
Temperature of medium	[°C]	–5 ... +50			
Relative humidity	[%]	0 ... 90			
CE marking (see declaration of conformity) ¹⁾		–	–	–	To EU Low Voltage Directive
UKCA marking (see declaration of conformity) ¹⁾		–	–	–	To UK EMC regulations
Certification ²⁾		c UL us - Recognized (OL)	c UL us - Recognized (OL)	–	–

1) For information about the area of use, see the EC declaration of conformity at: www.festo.com/catalogue/... → Support/Downloads.

If the devices are subject to usage restrictions in residential, commercial or light-industrial environments, further measures for the reduction of the emitted interference may be necessary.

2) More information: www.festo.com/catalogue/... → Support/Downloads.

Datasheet – Valve size 18 mm

Operating and control pressure			2x 2/2-way valve	2x 3/2-way valve	2x 3/2-way valve, reverse operation
Valve function					
Operating pressure	Internal pilot air supply	[MPa]	0.2 ... 1	0.2 ... 1	0.2 ... 1
		[bar]	2 ... 10	2 ... 10	2 ... 10
	External pilot air supply	[MPa]	0.2 ... 1	0.2 ... 1	-0.09 ... 1
		[bar]	2 ... 10	2 ... 10	-0.9 ... 10
Pilot pressure ¹⁾		[MPa]	0.3 ... 1	0.3 ... 1	0.3 ... 1
		[bar]	3 ... 10	3 ... 10	3 ... 10

1) Pilot pressure dependent on operating pressure → graph

Operating and control pressure			5/2-way valve		5/3-way valve
Valve function			Pneumatic spring	Mechanical spring	
Operating pressure	Internal pilot air supply	[MPa]	0.2 ... 1	0.3 ... 1	0.3 ... 1
		[bar]	2 ... 10	3 ... 10	3 ... 10
	External pilot air supply	[MPa]	-0.09 ... 1	-0.09 ... 1	-0.09 ... 1
		[bar]	-0.9 ... 10	-0.9 ... 10	-0.9 ... 10
Pilot pressure ¹⁾		[MPa]	0.3 ... 1	0.3 ... 1	0.3 ... 1
		[bar]	3 ... 10	3 ... 10	3 ... 10

1) Pilot pressure dependent on operating pressure → graph

Minimum pilot pressure p₁₂, p₁₄ as a function of operating pressure p₁ (external pilot air supply)

2x 3/2-way valve and 2/2-way valve

5/2-way valve and 5/3-way valve

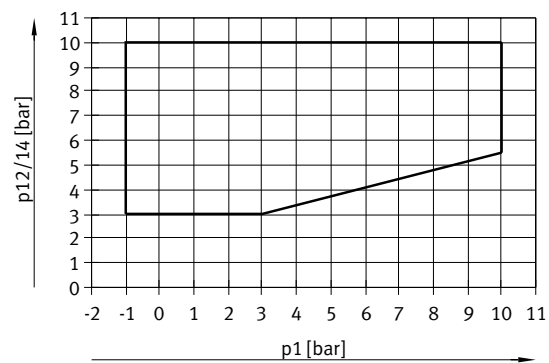
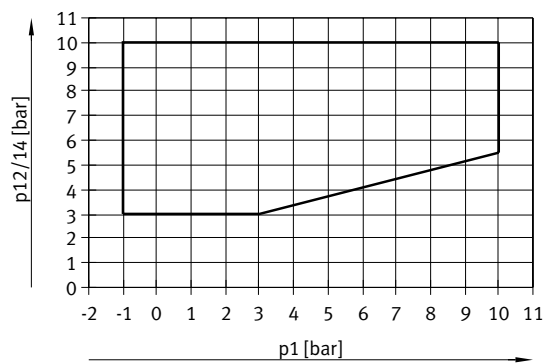

Electrical data

Electrical connection	Plug, square design to EN 175301-803, type C, 110 V/230 V AC with protective earth conductor		M12 plug, round design
Operating voltage	DC voltage	[V DC]	12, 24 +10%/-15%
	Alternating voltage	[V AC]	24, 110, 230 +10%/-15%
Characteristic coil data	DC voltage	[W]	1.8
	Alternating voltage	[VA]	At 24 V AC: • 3.1 pick-up power • 2.3 holding power At 110 V AC and 230 V AC: • 2.9 pick-up power • 2.1 holding power
Duty cycle	[%]	100	
Degree of protection to EN 60529	IP65, Nema 4 (in combination with plug socket)		

Materials

Housing	Die-cast aluminium
Seals	HNBR, NBR
Screws	Galvanised steel
Note on materials	RoHS-compliant
LABS (PWIS) conformity	VDMA24364-B1/B2-L

Datasheet – Valve size 18 mm

Dimensions

Download CAD data → www.festo.com

5/2-way valve, single solenoid with plug type C

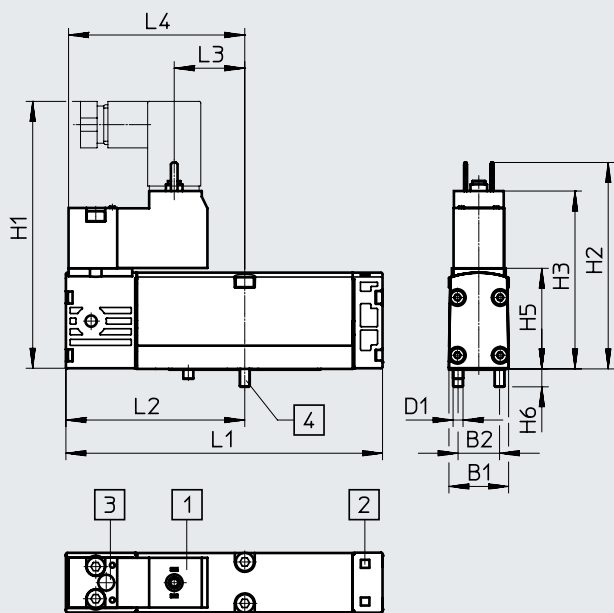

- [1] Connection sizes and connection for power supply to EN 175301-803, type C
- [2] Slot for inscription label
- [3] Manual override
- [4] Captive retaining screws

Type	B1	B2	D1	H1	H2	H3	H5	H6	L1	L2	L3	L4
VSVA-B-M52...C1	18	12.5	M3	80.6	62.2	53.6	30.3	5.4	95.4	53.9	21.3	53.1

Dimensions

Download CAD data → www.festo.com

5/2-way valve, single solenoid with M12 plug

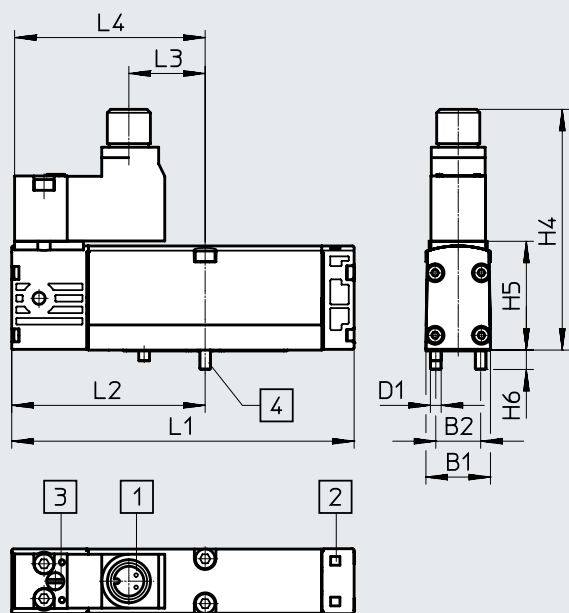

- [1] Connection sizes and connection for power supply, M12 plug
- [2] Slot for inscription label
- [3] Manual override
- [4] Captive retaining screws

Type	B1	B2	D1	H4	H5	H6	L1	L2	L3	L4
VSVA-B-M52...R3	18	12.5	M3	67	30.3	5.4	95.4	53.9	21.3	53.1

Datasheet – Valve size 18 mm

Dimensions

Download CAD data → www.festo.com

2x 2/2-way valve, 2x 3/2-way valve, 5/2-way valve double solenoid, 5/3-way valve

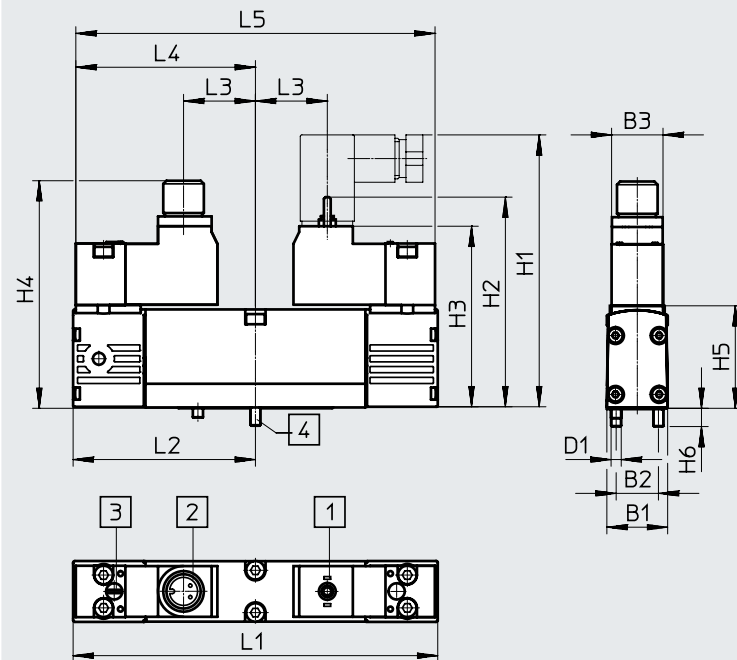

- [1] Connection sizes and connection for power supply to EN 175301-803, type C
- [2] Connection sizes and connection for power supply, M12 plug
- [3] Manual override
- [4] Captive retaining screws

Type	B1	B2	B3	D1	H1	H2	H3	H4	H5	H6	L1	L2	L3	L4	L5
VSVA-B-T22C	18	12.5	15.2	M3	80.6	62.2	53.6	67	30.3	5.4	107.8	53.9	21.3	53.1	102.2
VSVA-B-T32															
VSVA-B-B52															
VSVA-B-D52															
VSVA-B-P53															

Datasheet – Valve size 18 mm

Dimensions

Download CAD data → www.festo.com

Pilot valve with plug type C, VSCS-...C1

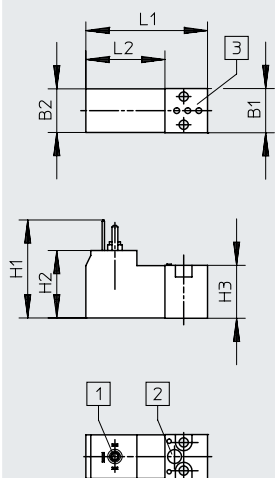

- [1] Connection sizes and connection for power supply to EN 175301-803, type C
- [2] Manual override
- [3] Pneumatic port pattern to ISO 15218

Type	B1	B2	D1	H1	H2	H3	L1	L2
VSCS-...C1	15.2	15	–	33.7	10.5	18.2	41.9	14.7

Dimensions

Download CAD data → www.festo.com

Pilot valve with M12 plug, VSCS-...R3

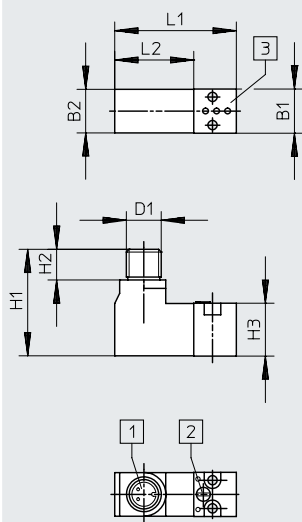

- [1] Connection sizes and connection for power supply, M12 plug
- [2] Manual override
- [3] Pneumatic port pattern to ISO 15218

Type	B1	B2	D1	H1	H2	H3	L1	L2
VSCS-...R3	15.2	15	M12	36.7	10.6	18.2	41.9	27.2

Datasheet – Valve size 18 mm

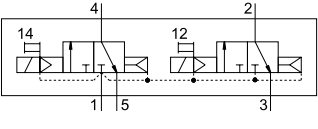
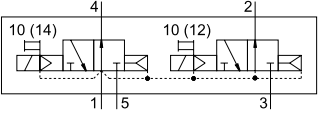
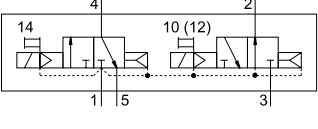
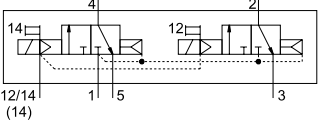
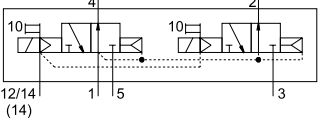
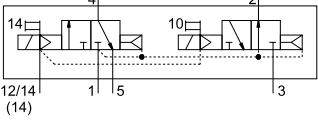
Ordering data – Pilot control fitted			Part no.	Type		
Code	Circuit symbol					
2x 2/2-way solenoid valve						
T22C	–	Order via online configurator	–	–		
2x 3/2-way solenoid valve, with pilot control with square plug, type C to EN 175301-803						
K		Normal position: 2x normally closed	Internal pilot air supply	24 V DC	546693	VSVA-B-T32C-AH-A2-1C1
				12 V DC	547129	VSVA-B-T32C-AH-A2-5C1
				230 V AC	547209	VSVA-B-T32C-AH-A2-3AC1
				110 V AC	547169	VSVA-B-T32C-AH-A2-2AC1
				24 V AC	547089	VSVA-B-T32C-AH-A2-1AC1
N		Normal position: 2x normally open	Internal pilot air supply	24 V DC	546695	VSVA-B-T32U-AH-A2-1C1
				12 V DC	547131	VSVA-B-T32U-AH-A2-5C1
				230 V AC	547211	VSVA-B-T32U-AH-A2-3AC1
				110 V AC	547171	VSVA-B-T32U-AH-A2-2AC1
				24 V AC	547091	VSVA-B-T32U-AH-A2-1AC1
H		Normal position: 1x normally closed 1x normally open	Internal pilot air supply	24 V DC	547067	VSVA-B-T32H-AH-A2-1C1
				12 V DC	547133	VSVA-B-T32H-AH-A2-5C1
				230 V AC	547213	VSVA-B-T32H-AH-A2-3AC1
				110 V AC	547173	VSVA-B-T32H-AH-A2-2AC1
				24 V AC	547093	VSVA-B-T32H-AH-A2-1AC1
K		Normal position: 2x normally closed	External pilot air supply	24 V DC	547069	VSVA-B-T32C-AZH-A2-1C1
				12 V DC	547149	VSVA-B-T32C-AZH-A2-5C1
				230 V AC	547229	VSVA-B-T32C-AZH-A2-3AC1
				110 V AC	547189	VSVA-B-T32C-AZH-A2-2AC1
				24 V AC	547109	VSVA-B-T32C-AZH-A2-1AC1
N		Normal position: 2x normally open	External pilot air supply	24 V DC	547071	VSVA-B-T32U-AZH-A2-1C1
				12 V DC	547151	VSVA-B-T32U-AZH-A2-5C1
				230 V AC	547231	VSVA-B-T32U-AZH-A2-3AC1
				110 V AC	547191	VSVA-B-T32U-AZH-A2-2AC1
				24 V AC	547111	VSVA-B-T32U-AZH-A2-1AC1
H		Normal position: 1x normally closed 1x normally open	External pilot air supply	24 V DC	547073	VSVA-B-T32H-AZH-A2-1C1
				12 V DC	547153	VSVA-B-T32H-AZH-A2-5C1
				230 V AC	547233	VSVA-B-T32H-AZH-A2-3AC1
				110 V AC	547193	VSVA-B-T32H-AZH-A2-2AC1
				24 V AC	547113	VSVA-B-T32H-AZH-A2-1AC1



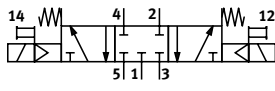
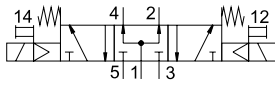
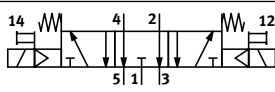
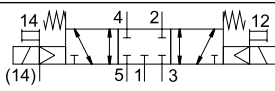
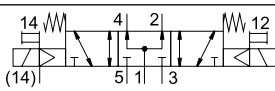
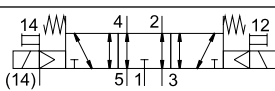

Datasheet – Valve size 18 mm

Ordering data – Pilot control fitted			Part no.	Type	
Code	Circuit symbol				
5/2-way valve, single solenoid, with pilot control with square plug, type C to EN 175301-803					
M		Pneumatic spring	Internal pilot air supply	24 V DC	546701 VSVA-B-M52-AH-A2-1C1
				12 V DC	547139 VSVA-B-M52-AH-A2-5C1
				230 V AC	547219 VSVA-B-M52-AH-A2-3AC1
				110 V AC	547179 VSVA-B-M52-AH-A2-2AC1
				24 V AC	547099 VSVA-B-M52-AH-A2-1AC1
O		Mechanical spring	Internal pilot air supply	24 V DC	546703 VSVA-B-M52-MH-A2-1C1
				12 V DC	547141 VSVA-B-M52-MH-A2-5C1
				230 V AC	547221 VSVA-B-M52-MH-A2-3AC1
				110 V AC	547181 VSVA-B-M52-MH-A2-2AC1
M		Pneumatic spring	External pilot air supply	24 V DC	547079 VSVA-B-M52-AZH-A2-1C1
				12 V DC	547159 VSVA-B-M52-AZH-A2-5C1
				230 V AC	547239 VSVA-B-M52-AZH-A2-3AC1
				110 V AC	547199 VSVA-B-M52-AZH-A2-2AC1
				24 V AC	547119 VSVA-B-M52-AZH-A2-1AC1
O		Mechanical spring	External pilot air supply	24 V DC	547081 VSVA-B-M52-MZH-A2-1C1
				12 V DC	547161 VSVA-B-M52-MZH-A2-5C1
				230 V AC	547241 VSVA-B-M52-MZH-A2-3AC1
				110 V AC	547201 VSVA-B-M52-MZH-A2-2AC1
				24 V AC	547121 VSVA-B-M52-MZH-A2-1AC1
5/2-way valve, double solenoid, with pilot control with square plug, type C to EN 175301-803					
J		Dominant 1st signal	Internal pilot air supply	24 V DC	546697 VSVA-B-B52-H-A2-1C1
				12 V DC	547135 VSVA-B-B52-H-A2-5C1
				230 V AC	547215 VSVA-B-B52-H-A2-3AC1
				110 V AC	547175 VSVA-B-B52-H-A2-2AC1
				24 V AC	547095 VSVA-B-B52-H-A2-1AC1
D		Dominant at 14	Internal pilot air supply	24 V DC	546699 VSVA-B-D52-H-A2-1C1
				12 V DC	547137 VSVA-B-D52-H-A2-5C1
				230 V AC	547217 VSVA-B-D52-H-A2-3AC1
				110 V AC	547177 VSVA-B-D52-H-A2-2AC1
J		Dominant 1st signal	External pilot air supply	24 V DC	547075 VSVA-B-B52-ZH-A2-1C1
				12 V DC	547155 VSVA-B-B52-ZH-A2-5C1
				230 V AC	547235 VSVA-B-B52-ZH-A2-3AC1
				110 V AC	547195 VSVA-B-B52-ZH-A2-2AC1
				24 V AC	547115 VSVA-B-B52-ZH-A2-1AC1
D		Dominant at 14	External pilot air supply	24 V DC	547077 VSVA-B-D52-ZH-A2-1C1
				12 V DC	547157 VSVA-B-D52-ZH-A2-5C1
				230 V AC	547237 VSVA-B-D52-ZH-A2-3AC1
				110 V AC	547197 VSVA-B-D52-ZH-A2-2AC1
24 V AC	547117 VSVA-B-D52-ZH-A2-1AC1				

Datasheet – Valve size 18 mm

Ordering data – Pilot control fitted				Part no.	Type	
Code	Circuit symbol					
5/3-way solenoid valve, with pilot control with square plug, type C to EN 175301-803						
G		Normal position: Closed	Internal pilot air supply	24 V DC	546709	VSVA-B-P53C-H-A2-1C1
				12 V DC	547147	VSVA-B-P53C-H-A2-5C1
				230 V AC	547227	VSVA-B-P53C-H-A2-3AC1
				110 V AC	547187	VSVA-B-P53C-H-A2-2AC1
				24 V AC	547107	VSVA-B-P53C-H-A2-1AC1
B		Normal position: Open	Internal pilot air supply	24 V DC	546705	VSVA-B-P53U-H-A2-1C1
				12 V DC	547143	VSVA-B-P53U-H-A2-5C1
				230 V AC	547223	VSVA-B-P53U-H-A2-3AC1
				110 V AC	547183	VSVA-B-P53U-H-A2-2AC1
				24 V AC	547103	VSVA-B-P53U-H-A2-1AC1
E		Normal position: Exhausted	Internal pilot air supply	24 V DC	546707	VSVA-B-P53E-H-A2-1C1
				12 V DC	547145	VSVA-B-P53E-H-A2-5C1
				230 V AC	547225	VSVA-B-P53E-H-A2-3AC1
				110 V AC	547185	VSVA-B-P53E-H-A2-2AC1
				24 V AC	547105	VSVA-B-P53E-H-A2-1AC1
G		Normal position: Closed	External pilot air supply	24 V DC	547087	VSVA-B-P53C-ZH-A2-1C1
				12 V DC	547167	VSVA-B-P53C-ZH-A2-5C1
				230 V AC	547247	VSVA-B-P53C-ZH-A2-3AC1
				110 V AC	547207	VSVA-B-P53C-ZH-A2-2AC1
				24 V AC	547127	VSVA-B-P53C-ZH-A2-1AC1
B		Normal position: Open	External pilot air supply	24 V DC	547083	VSVA-B-P53U-ZH-A2-1C1
				12 V DC	547163	VSVA-B-P53U-ZH-A2-5C1
				230 V AC	547243	VSVA-B-P53U-ZH-A2-3AC1
				110 V AC	547203	VSVA-B-P53U-ZH-A2-2AC1
				24 V AC	547123	VSVA-B-P53U-ZH-A2-1AC1
E		Normal position: Exhausted	External pilot air supply	24 V DC	547085	VSVA-B-P53E-ZH-A2-1C1
				12 V DC	547165	VSVA-B-P53E-ZH-A2-5C1
				230 V AC	547245	VSVA-B-P53E-ZH-A2-3AC1
				110 V AC	547205	VSVA-B-P53E-ZH-A2-2AC1
				24 V AC	547125	VSVA-B-P53E-ZH-A2-1AC1

Datasheet – Valve size 18 mm

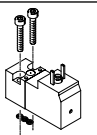
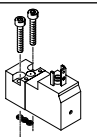
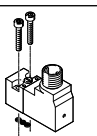
Ordering data – Pilot control separate			Part no.	Type	
2x 3/2-way valve without pilot valves					
	Internal pilot air supply	2x normally closed	546732	VSVA-B-T32C-A-A2-P1	
		2x normally open	546734	VSVA-B-T32U-A-A2-P1	
5/2-way single solenoid valve without pilot valve					
	Internal pilot air supply	Pneumatic spring	546740	VSVA-B-M52-A-A2-P1	
		Mechanical spring	546742	VSVA-B-M52-M-A2-P1	
5/2-way double solenoid valve without pilot valve					
	Internal pilot air supply	Dominant 1st signal	546736	VSVA-B-B52-A2-P1	
		Dominant at 14	546738	VSVA-B-D52-A2-P1	
5/3-way mid-position valve without pilot valves					
	Internal pilot air supply	Normally closed	546748	VSVA-B-P53C-A2-P1	
		Normally open	546744	VSVA-B-P53U-A2-P1	
		Normally exhausted	546746	VSVA-B-P53E-A2-P1	
Pilot valve to ISO 15218					
	Square plug, type C to EN 175301-803	12 V DC	Non-detenting manual override	546257	VSCS-B-M32-MH-WA-5C1
			Non-detenting/detenting manual override	571062	VSCS-B-M32-MD-WA-5C1
		24 V DC	Non-detenting manual override	546256	VSCS-B-M32-MH-WA-1C1
			Non-detenting/detenting manual override	571061	VSCS-B-M32-MD-WA-1C1
		24 V AC	Non-detenting manual override	546258	VSCS-B-M32-MH-WA-1AC1
			Non-detenting/detenting manual override	571063	VSCS-B-M32-MD-WA-1AC1
	Square plug, type C to EN 175301-803, With PE conductor	110 V AC	Non-detenting manual override	546259	VSCS-B-M32-MH-WA-2AC1
			Non-detenting/detenting manual override	571064	VSCS-B-M32-MD-WA-2AC1
		230 V AC	Non-detenting manual override	546260	VSCS-B-M32-MH-WA-3AC1
			Non-detenting/detenting manual override	571065	VSCS-B-M32-MD-WA-3AC1
	M12 round plug to IEC 61076-2-101	24 V DC	Non-detenting manual override	573214	VSCS-B-M32-MH-WA-1R3
			Non-detenting/detenting manual override	573215	VSCS-B-M32-MD-WA-1R3

Datasheet – Valve size 26 mm

-  - Flow rate
max. 1400 l/min

-  - Voltage
12, 24 V DC
24, 110, 230 V AC

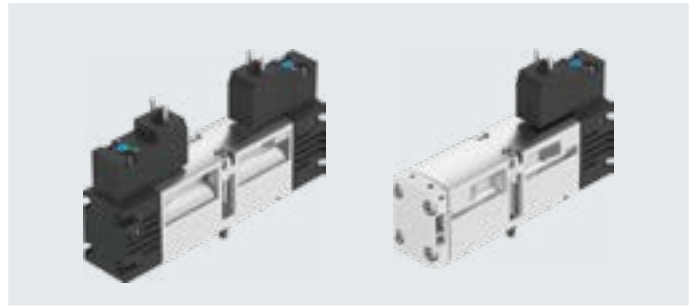

General technical data		2x 2/2-way valve	2x 3/2-way valve	5/2-way valve	5/3-way valve	
Valve function						
Normal position		C ¹⁾	C ¹⁾ , U ²⁾ , H ⁴⁾ , N ⁵⁾ , F ⁶⁾ , W ⁷⁾	–	–	C ¹⁾ , U ²⁾ , E ³⁾
Stable position		Monostable	Monostable	Monostable	Bistable	Monostable
Pneumatic spring return		Yes	Yes	Yes	–	No
Mechanical spring return		No	No	Yes	–	Yes
Design		Piston spool				
Overlap		Positive overlap				
Sealing principle		Soft				
Actuation type		Electrical				
Type of control		Piloted				
Pilot interface		To ISO 15218				
Pilot air supply		Internal or external				
Pilot air supply, exhaust air		Not ducted as per standard, or ducted				
Flow direction		Not reversible or reversible	Not reversible or only reversible	Reversible with external pilot air supply		
Exhaust air function		Can be throttled				
Manual override		Non-detenting, non-detenting/detenting				
Type of mounting		On sub-base				
Mounting position		Any				
Nominal size	[mm]	9				
Valve size	[mm]	26				
Ports on the sub-base	1, 2, 3, 4, 5 12, 14	G1/4 M5				
Tightening torque for valve mounting	[Nm]	1.8 ... 2.2				
Product weight	Without pilot valve [g] Solenoid valve [g]	229 305	229 305	142 180	229 305	229 305
Noise level	[dB (A)]	85				
Conforms to		ISO 15407-1, VDMA 24563 and for pilot valve interface ISO 15218				

- 1) C = Normally closed
 2) U = Normally open
 3) E = Normally exhausted
 4) H=2x 3/2-way valve in one housing with 1x normally closed and 1x normally open
 5) N=Normally closed, reverse operation, i.e. the pressure supply ports are 3 and 5, exhausting is via port 1
 6) F=Normally open, reverse operation, i.e. the pressure supply ports are 3 and 5, exhausting is via port 1
 7) W=2x 3/2-way valve in one housing with 1x normally closed and 1x normally open, reverse operation, i.e. the pressure supply ports are 3 and 5, exhausting is via port 1

Flow rates		2x 2/2-way valve	2x 3/2-way valve	5/2-way valve	5/3-way valve
Valve function					
Flow rate of valve	[l/min]	1350	1250	1400	1400
Flow rate of valve on individual sub-base	[l/min]	1000	1000	1100	1100
Flow rate of pneumatically linked valve	[l/min]	1000	900	1100	1000
Standard nominal flow rate	[l/min]	1000	900	1100	1000

Datasheet – Valve size 26 mm

Switching times [ms]		Switching time on	Switching time off	Switching time changeover	Switching time changeover (dominant)
2x 2/2-way valve		20	28	–	–
2x 3/2-way valve		20	28	–	–
2x 3/2-way valve, reversible		28	20	–	–
5/2-way valve	Pneumatic spring	35	43	–	–
	Mechanical spring	26	56	–	–
5/2-way valve, double solenoid		–	–	18	18
5/3-way valve		23	58	35	–

Safety data		VSVA-...-1C1	VSVA-...-P1	VSVA-...-5C1 VSVA-...-1AC1	VSVA-...-2AC1 VSVA-...-3AC1
Type					
Max. positive test pulse with logic 0	[µs]	1800	–	–	–
Max. negative test pulse with logic 1	[µs]	800	–	–	–
Shock resistance		Shock test with severity level 2 in accordance with FN 942017-5 and EN 60068-2-27			
Vibration resistance		Transport application test with severity level 2 to FN 942017-4 and EN 60068-2-6			

Operating and environmental conditions		VSVA-...-1C1	VSVA-...-P1	VSVA-...-5C1 VSVA-...-1AC1	VSVA-...-2AC1 VSVA-...-3AC1
Type					
Operating medium		Compressed air to ISO 8573-1:2010 [7:4:4]			
Pilot medium		Compressed air to ISO 8573-1:2010 [7:4:4]			
Note on the operating/pilot medium		Lubricated operation possible (in which case lubricated operation will always be required)			
Ambient temperature	[°C]	–5 ... +50			
Temperature of medium	[°C]	–5 ... +50			
Relative humidity	[%]	0 ... 90			
CE marking (see declaration of conformity) ¹⁾		–	–	–	To EU Low Voltage Directive
UKCA marking (see declaration of conformity) ¹⁾		–	–	–	To UK EMC regulations
Certification ²⁾		c UL us - Recognized (OL)	c UL us - Recognized (OL)	–	–

1) For information about the area of use, see the EC declaration of conformity at: www.festo.com/catalogue/... → Support/Downloads.

If the devices are subject to usage restrictions in residential, commercial or light-industrial environments, further measures for the reduction of the emitted interference may be necessary.

2) More information: www.festo.com/catalogue/... → Support/Downloads.

Operating and control pressure		2x 2/2-way valve	2x 3/2-way valve	2x 3/2-way valve, reverse operation
Valve function				
Operating pressure	Internal pilot air supply	[MPa]	0.2 ... 1	0.2 ... 1
		[bar]	2 ... 10	2 ... 10
	External pilot air supply	[MPa]	0.2 ... 1	0.2 ... 1
		[bar]	2 ... 10	2 ... 10
Pilot pressure ¹⁾	[MPa]	0.3 ... 1	0.3 ... 1	
	[bar]	3 ... 10	3 ... 10	

1) Pilot pressure dependent on operating pressure → graph

Datasheet – Valve size 26 mm

Operating and control pressure			5/2-way valve		5/3-way valve
			Pneumatic spring	Mechanical spring	
Valve function	Internal pilot air supply	[MPa]	0.2 ... 1	0.3 ... 1	0.3 ... 1
		[bar]	2 ... 10	3 ... 10	3 ... 10
Operating pressure	External pilot air supply	[MPa]	-0.09 ... 1.6	-0.09 ... 1.6	-0.09 ... 1.6
		[bar]	-0.9 ... 16	-0.9 ... 16	-0.9 ... 16
Pilot pressure ¹⁾		[MPa]	0.3 ... 1	0.3 ... 1	0.3 ... 1
		[bar]	3 ... 10	3 ... 10	3 ... 10

1) Pilot pressure dependent on operating pressure → graph

Minimum pilot pressure p₁₂, p₁₄ as a function of operating pressure p₁ (external pilot air supply)

2x 3/2-way solenoid valve and 2/2-way solenoid valve

5/2-way solenoid valve and 5/3-way solenoid valve

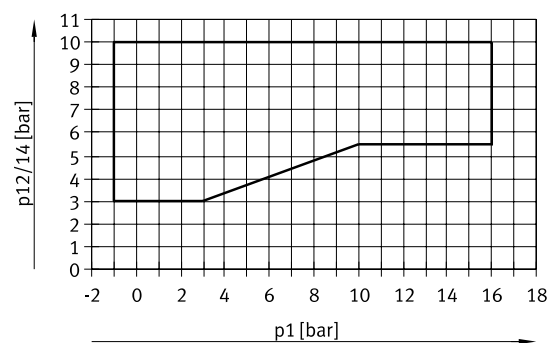
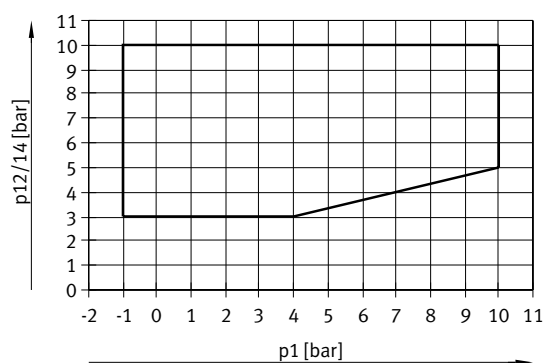

Electrical data

Electrical connection	Plug, square design to EN 175301-803, type C, 110 V/230 V AC with protective earth conductor		M12 plug, round design
Operating voltage	DC voltage	[V DC]	12, 24 +10%/-15%
	Alternating voltage	[V AC]	24, 110, 230 +10%/-15%
Characteristic coil data	DC voltage	[W]	1.8
	Alternating voltage	[VA]	At 24 V AC: • 3.1 pick-up power • 2.3 holding power
Duty cycle	[%]	100	
Degree of protection to EN 60529	IP65, Nema 4 (in combination with plug socket)		

Materials

Housing	Die-cast aluminium
Seals	HNBR, NBR
Screws	Galvanised steel
Note on materials	RoHS-compliant
LABS (PWIS) conformity	VDMA24364-B1/B2-L

Datasheet – Valve size 26 mm

Dimensions

Download CAD data → www.festo.com

5/2-way valve, single solenoid with plug type C

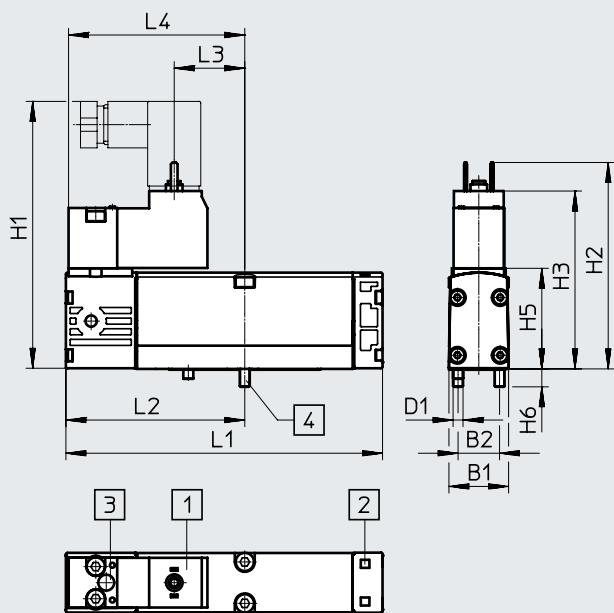

- [1] Connection sizes and connection for power supply to EN 175301-803, type C
- [2] Slot for inscription label
- [3] Manual override
- [4] Captive retaining screws

Type	B1	B2	D1	H1	H2	H3	H5	H6	L1	L2	L3	L4
VSVA-B-M52...C1	26.3	19	M4	89.2	71.2	62.6	39.3	7	113.1	63.1	29.8	61.6

Dimensions

Download CAD data → www.festo.com

5/2-way valve, single solenoid with M12 plug

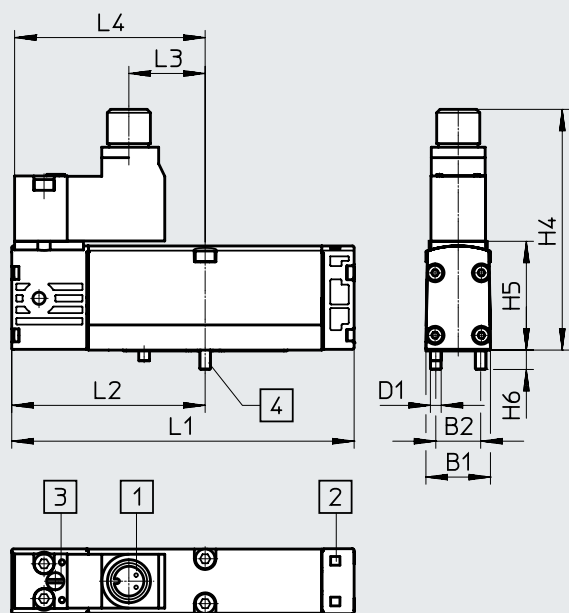

- [1] Connection sizes and connection for power supply, M12 plug
- [2] Slot for inscription label
- [3] Manual override
- [4] Captive retaining screws

Type	B1	B2	D1	H4	H5	H6	L1	L2	L3	L4
VSVA-B-M52...R3	26.3	19	M4	76.1	39.3	7	113.1	63.1	29.8	61.6

Datasheet – Valve size 26 mm

Dimensions

Download CAD data → www.festo.com

2x 2/2-way valve, 2x 3/2-way valve, 5/2-way valve double solenoid, 5/3-way valve

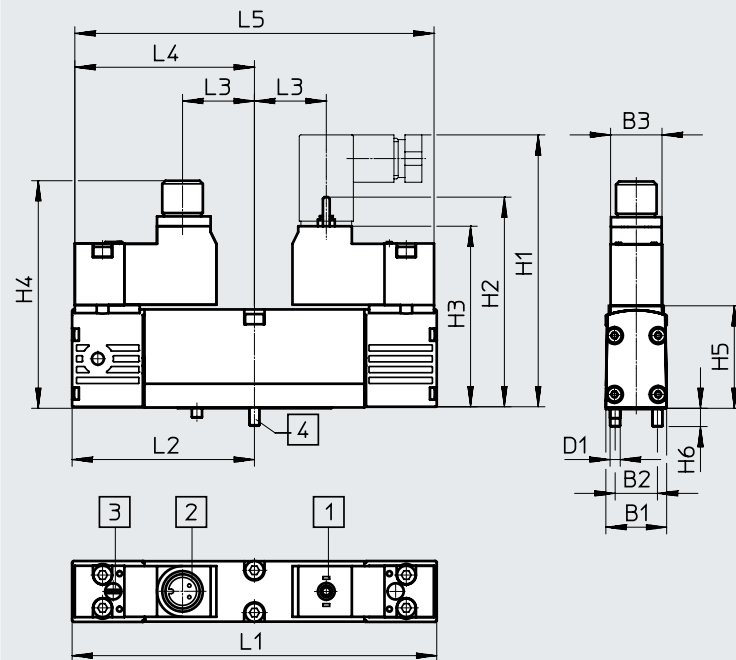

- [1] Connection sizes and connection for power supply to EN 175301-803, type C
- [2] Connection sizes and connection for power supply, M12 plug
- [3] Manual override
- [4] Captive retaining screws

Type	B1	B2	B3	D1	H1	H2	H3	H4	H5	H6	L1	L2	L3	L4	L5
VSVA-B-T22C	26.3	19	15.2	M4	89.2	71.2	62.6	76.1	39.3	7	126.2	63.1	29.8	61.6	123.2
VSVA-B-T32															
VSVA-B-B52															
VSVA-B-D52															
VSVA-B-P53															

Datasheet – Valve size 26 mm

Dimensions

Download CAD data → www.festo.com

Pilot valve with plug type C, VSCS-...C1

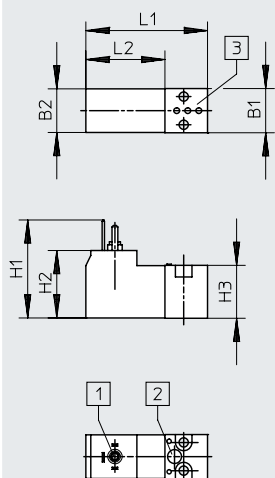

- [1] Connection sizes and connection for power supply to EN 175301-803, type C
- [2] Manual override
- [3] Pneumatic port pattern to ISO 15218

Type	B1	B2	D1	H1	H2	H3	L1	L2
VSCS-...C1	15.2	15	–	33.7	10.5	18.2	41.9	14.7

Dimensions

Download CAD data → www.festo.com

Pilot valve with M12 plug, VSCS-...R3

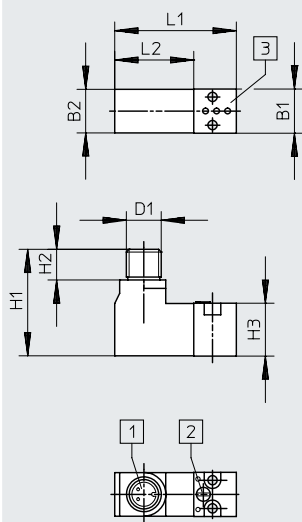

- [1] Connection sizes and connection for power supply, M12 plug
- [2] Manual override
- [3] Pneumatic port pattern to ISO 15218

Type	B1	B2	D1	H1	H2	H3	L1	L2
VSCS-...R3	15.2	15	M12	36.7	10.6	18.2	41.9	27.2

Datasheet – Valve size 26 mm

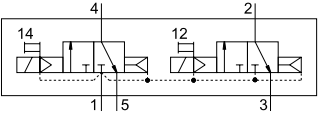
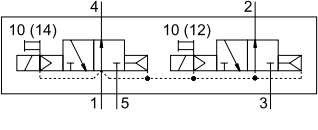
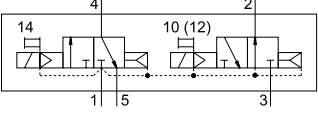
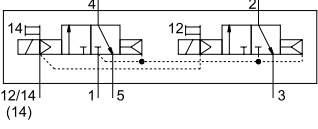
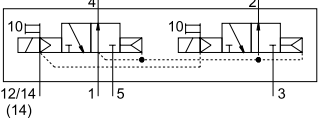
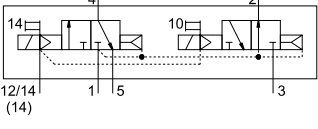
Ordering data – Pilot control fitted						
Code	Circuit symbol		Part no.	Type		
2x 2/2-way solenoid valve						
T22C	–	Order via online configurator	–	–		
2x 3/2-way solenoid valve, with pilot control with square plug, type C to EN 175301-803						
K		Normal position: 2x closed	Internal pilot air supply	24 V DC	546692	VSVA-B-T32C-AH-A1-1C1
				12 V DC	547128	VSVA-B-T32C-AH-A1-5C1
				230 V AC	547208	VSVA-B-T32C-AH-A1-3AC1
				110 V AC	547168	VSVA-B-T32C-AH-A1-2AC1
				24 V AC	547088	VSVA-B-T32C-AH-A1-1AC1
N		Normal position: 2x normally open	Internal pilot air supply	24 V DC	546694	VSVA-B-T32U-AH-A1-1C1
				12 V DC	547130	VSVA-B-T32U-AH-A1-5C1
				230 V AC	547210	VSVA-B-T32U-AH-A1-3AC1
				110 V AC	547170	VSVA-B-T32U-AH-A1-2AC1
				24 V AC	547090	VSVA-B-T32U-AH-A1-1AC1
H		Normal position: 1x normally closed 1x normally open	Internal pilot air supply	24 V DC	547066	VSVA-B-T32H-AH-A1-1C1
				12 V DC	547132	VSVA-B-T32H-AH-A1-5C1
				230 V AC	547212	VSVA-B-T32H-AH-A1-3AC1
				110 V AC	547172	VSVA-B-T32H-AH-A1-2AC1
				24 V AC	547092	VSVA-B-T32H-AH-A1-1AC1
K		Normal position: 2x normally closed	External pilot air supply	24 V DC	547068	VSVA-B-T32C-AZH-A1-1C1
				12 V DC	547148	VSVA-B-T32C-AZH-A1-5C1
				230 V AC	547228	VSVA-B-T32C-AZH-A1-3AC1
				110 V AC	547188	VSVA-B-T32C-AZH-A1-2AC1
				24 V AC	547108	VSVA-B-T32C-AZH-A1-1AC1
N		Normal position: 2x normally open	External pilot air supply	24 V DC	547070	VSVA-B-T32U-AZH-A1-1C1
				12 V DC	547150	VSVA-B-T32U-AZH-A1-5C1
				230 V AC	547230	VSVA-B-T32U-AZH-A1-3AC1
				110 V AC	547190	VSVA-B-T32U-AZH-A1-2AC1
				24 V AC	547110	VSVA-B-T32U-AZH-A1-1AC1
H		Normal position: 1x normally closed 1x normally open	External pilot air supply	24 V DC	547072	VSVA-B-T32H-AZH-A1-1C1
				12 V AC	547152	VSVA-B-T32H-AZH-A1-5C1
				230 V AC	547232	VSVA-B-T32H-AZH-A1-3AC1
				110 V AC	547192	VSVA-B-T32H-AZH-A1-2AC1
				24 V AC	547112	VSVA-B-T32H-AZH-A1-1AC1



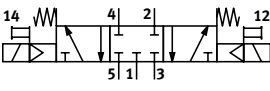
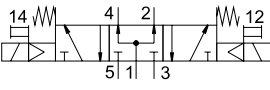
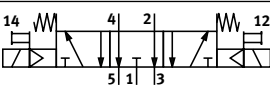
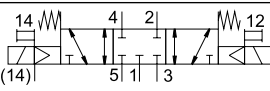
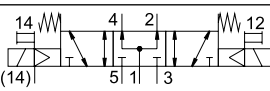
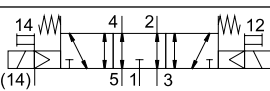

Datasheet – Valve size 26 mm

Ordering data – Pilot control fitted		Part no.	Type			
Code	Circuit symbol					
5/2-way valve, single solenoid, with pilot control with square plug, type C to EN 175301-803						
M		Pneumatic spring	Internal pilot air supply	24 V DC	546700	VSVA-B-M52-AH-A1-1C1
				12 V DC	547138	VSVA-B-M52-AH-A1-5C1
				230 V AC	547218	VSVA-B-M52-AH-A1-3AC1
				110 V AC	547178	VSVA-B-M52-AH-A1-2AC1
				24 V AC	547098	VSVA-B-M52-AH-A1-1AC1
O		Mechanical spring	Internal pilot air supply	24 V DC	546702	VSVA-B-M52-MH-A1-1C1
				12 V DC	547140	VSVA-B-M52-MH-A1-5C1
				230 V AC	547220	VSVA-B-M52-MH-A1-3AC1
				110 V AC	547180	VSVA-B-M52-MH-A1-2AC1
				24 V AC	547100	VSVA-B-M52-MH-A1-1AC1
M		Pneumatic spring	External pilot air supply	24 V DC	547078	VSVA-B-M52-AZH-A1-1C1
				12 V DC	547158	VSVA-B-M52-AZH-A1-5C1
				230 V AC	547238	VSVA-B-M52-AZH-A1-3AC1
				110 V AC	547198	VSVA-B-M52-AZH-A1-2AC1
				24 V AC	547118	VSVA-B-M52-AZH-A1-1AC1
O		Mechanical spring	External pilot air supply	24 V DC	547080	VSVA-B-M52-MZH-A1-1C1
				12 V DC	547160	VSVA-B-M52-MZH-A1-5C1
				230 V AC	547240	VSVA-B-M52-MZH-A1-3AC1
				110 V AC	547200	VSVA-B-M52-MZH-A1-2AC1
				24 V AC	547120	VSVA-B-M52-MZH-A1-1AC1
5/2-way valve, double solenoid, with pilot control with square plug, type C to EN 175301-803						
J		Dominant 1st signal	Internal pilot air supply	24 V DC	546696	VSVA-B-B52-H-A1-1C1
				12 V DC	547134	VSVA-B-B52-H-A1-5C1
				230 V AC	547214	VSVA-B-B52-H-A1-3AC1
				110 V AC	547174	VSVA-B-B52-H-A1-2AC1
				24 V AC	547094	VSVA-B-B52-H-A1-1AC1
D		Dominant at 14	Internal pilot air supply	24 V DC	546698	VSVA-B-D52-H-A1-1C1
				12 V DC	547136	VSVA-B-D52-H-A1-5C1
				230 V AC	547216	VSVA-B-D52-H-A1-3AC1
				110 V AC	547176	VSVA-B-D52-H-A1-2AC1
				24 V AC	547096	VSVA-B-D52-H-A1-1AC1
J		Dominant 1st signal	External pilot air supply	24 V DC	547074	VSVA-B-B52-ZH-A1-1C1
				12 V DC	547154	VSVA-B-B52-ZH-A1-5C1
				230 V AC	547234	VSVA-B-B52-ZH-A1-3AC1
				110 V AC	547194	VSVA-B-B52-ZH-A1-2AC1
				24 V AC	547114	VSVA-B-B52-ZH-A1-1AC1
D		Dominant at 14	External pilot air supply	24 V DC	547076	VSVA-B-D52-ZH-A1-1C1
				12 V DC	547156	VSVA-B-D52-ZH-A1-5C1
				230 V AC	547236	VSVA-B-D52-ZH-A1-3AC1
				110 V AC	547196	VSVA-B-D52-ZH-A1-2AC1
				24 V AC	547116	VSVA-B-D52-ZH-A1-1AC1

Datasheet – Valve size 26 mm

Ordering data – Pilot control fitted				Part no.	Type
Code	Circuit symbol				
5/3-way solenoid valve, with pilot control with square plug, type C to EN 175301-803					
G		Normal position: Closed	Internal pilot air supply	24 V DC	546708 VSVA-B-P53C-H-A1-1C1
				12 V DC	547146 VSVA-B-P53C-H-A1-5C1
				230 V AC	547226 VSVA-B-P53C-H-A1-3AC1
				110 V AC	547186 VSVA-B-P53C-H-A1-2AC1
				24 V AC	547106 VSVA-B-P53C-H-A1-1AC1
B		Normal position: Open	Internal pilot air supply	24 V DC	546704 VSVA-B-P53U-H-A1-1C1
				12 V DC	547142 VSVA-B-P53U-H-A1-5C1
				230 V AC	547222 VSVA-B-P53U-H-A1-3AC1
				110 V AC	547182 VSVA-B-P53U-H-A1-2AC1
				24 V AC	547102 VSVA-B-P53U-H-A1-1AC1
E		Normal position: Exhausted	Internal pilot air supply	24 V DC	546706 VSVA-B-P53E-H-A1-1C1
				12 V DC	547144 VSVA-B-P53E-H-A1-5C1
				230 V AC	547224 VSVA-B-P53E-H-A1-3AC1
				110 V AC	547184 VSVA-B-P53E-H-A1-2AC1
				24 V AC	547104 VSVA-B-P53E-H-A1-1AC1
G		Normal position: Closed	External pilot air supply	24 V DC	547086 VSVA-B-P53C-ZH-A1-1C1
				12 V DC	547166 VSVA-B-P53C-ZH-A1-5C1
				230 V AC	547246 VSVA-B-P53C-ZH-A1-3AC1
				110 V AC	547206 VSVA-B-P53C-ZH-A1-2AC1
				24 V AC	547126 VSVA-B-P53C-ZH-A1-1AC1
B		Normal position: Open	External pilot air supply	24 V DC	547082 VSVA-B-P53U-ZH-A1-1C1
				12 V DC	547162 VSVA-B-P53U-ZH-A1-5C1
				230 V AC	547242 VSVA-B-P53U-ZH-A1-3AC1
				110 V AC	547202 VSVA-B-P53U-ZH-A1-2AC1
				24 V AC	547122 VSVA-B-P53U-ZH-A1-1AC1
E		Normal position: Exhausted	External pilot air supply	24 V DC	547084 VSVA-B-P53E-ZH-A1-1C1
				12 V DC	547164 VSVA-B-P53E-ZH-A1-5C1
				230 V AC	547244 VSVA-B-P53E-ZH-A1-3AC1
				110 V AC	547204 VSVA-B-P53E-ZH-A1-2AC1
				24 V AC	547124 VSVA-B-P53E-ZH-A1-1AC1

Datasheet – Valve size 26 mm

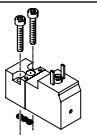
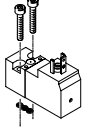
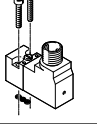
Ordering data – Pilot control separate			Part no.	Type	
2x 3/2-way valve without pilot valves					
	Internal pilot air supply	2x normally closed	546731	VSVA-B-T32C-A-A1-P1	
		2x normally open	546733	VSVA-B-T32U-A-A1-P1	
5/2-way single solenoid valve without pilot valve					
	Internal pilot air supply	Pneumatic	546739	VSVA-B-M52-A-A1-P1	
		Mechanical spring	546741	VSVA-B-M52-M-A1-P1	
5/2-way double solenoid valve without pilot valve					
	Internal pilot air supply	Dominant 1st signal	546735	VSVA-B-B52-A1-P1	
		Dominant at 14	546737	VSVA-B-D52-A1-P1	
5/3-way mid-position valve without pilot valves					
	Internal pilot air supply	Normally closed	546747	VSVA-B-P53C-A1-P1	
		Normally open	546743	VSVA-B-P53U-A1-P1	
		Normally exhausted	546745	VSVA-B-P53E-A1-P1	
Pilot valve to ISO 15218					
	Square plug, type C to EN 175301-803	12 V DC	Non-detenting manual override	546257	VSCS-B-M32-MH-WA-5C1
			Non-detenting/detenting manual override	571062	VSCS-B-M32-MD-WA-5C1
		24 V DC	Non-detenting manual override	546256	VSCS-B-M32-MH-WA-1C1
			Non-detenting/detenting manual override	571061	VSCS-B-M32-MD-WA-1C1
		24 V AC	Non-detenting manual override	546258	VSCS-B-M32-MH-WA-1AC1
			Non-detenting/detenting manual override	571063	VSCS-B-M32-MD-WA-1AC1
	Square plug, type C to EN 175301-803, With PE conductor	110 V AC	Non-detenting manual override	546259	VSCS-B-M32-MH-WA-2AC1
			Non-detenting/detenting manual override	571064	VSCS-B-M32-MD-WA-2AC1
		230 V AC	Non-detenting manual override	546260	VSCS-B-M32-MH-WA-3AC1
			Non-detenting/detenting manual override	571065	VSCS-B-M32-MD-WA-3AC1
	M12 round plug to IEC 61076-2-101	24 V DC	Non-detenting manual override	573214	VSCS-B-M32-MH-WA-1R3
			Non-detenting/detenting manual override	573215	VSCS-B-M32-MD-WA-1R3

Datasheet – Valve size 26 mm, valve with position detection

-  - Flow rate
max. 1400 l/min

-  - Voltage
24 V DC

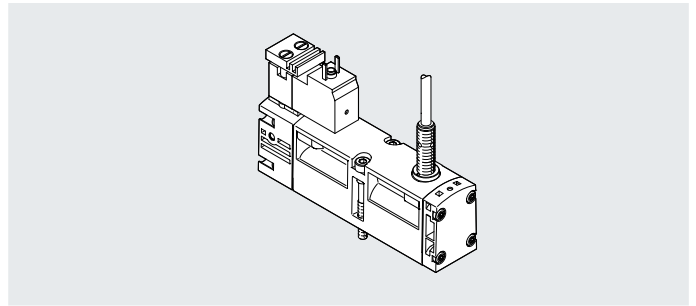

ISO valves with switching position sensing for safety-related pneumatic components

The 5/2-way single solenoid valve with spring return contains an inductive sensor that monitors the normal position of the piston spool valve.

This valve is not a safety device to the Machinery Directive 2006/42/EC.

For use in higher categories, the sensor signal from the valve must be evaluated by a control unit.

This valve is suitable for use in safety-related parts of control systems to EN ISO 13849-1. This valve is designed for installation in machines and automation systems and must only be used in industrial applications (high-demand mode).

The circuit diagram represents a valve with a proximity switch with a N/O switching output signal. In accordance with ISO 1219-1, this symbol is used both for normally open contacts and for normally closed contacts. The switching element function of the sensors used here is designed as an N/C contact.

General technical data

Valve function		5/2
Piston position sensing		Normal position with sensor
Stable position		Monostable
Reset method		Mechanical spring
Design		Piston spool
Overlap		Positive overlap
Sealing principle		Soft
Actuation type		Electrical
Type of control		Piloted
Pilot interface		To ISO 15218
Pilot air supply		External
Pilot air supply, exhaust air		Optionally ducted/not ducted
Flow direction		Any
Exhaust air function		Can be throttled, via throttle plate, via individual sub-base
Manual override		Concealed
Type of mounting		On sub-base
Mounting position		Any
Nominal size	[mm]	9
Valve size	[mm]	26
Ports on the sub-base	1, 2, 3, 4, 5 12, 14	G1/4 M5
Tightening torque for valve mounting	[Nm]	1.8 ... 2.2
Product weight	With 1x M8 plug [g] with open cable end [g]	289 332
Noise level	[dB (A)]	85
Conforms to		ISO 15407-1, VDMA 24563

Flow rates

Flow rate of valve	[l/min]	1400
Flow rate of valve on individual sub-base	[l/min]	1100
Flow rate of pneumatically linked valve	[l/min]	1100
Standard nominal flow rate	[l/min]	1100

Datasheet – Valve size 26 mm, valve with position detection

Switching times [ms]		Switching time on	Switching time off
5/2-way valve	Mechanical spring	21	41

Safety data	
CE marking (see declaration of conformity)	To EU EMC Directive ¹⁾
UKCA marking (see declaration of conformity) ¹⁾	To UK EMC regulations
KC marking	KC EMC
Max. positive test pulse with logic 0	[μs] 1000
Max. negative test pulse with logic 1	[μs] 800
Shock resistance	Shock test with severity level 2 in accordance with FN 942017-5 and EN 60068-2-27
Vibration resistance	Transport application test with severity level 2 to FN 942017-4 and EN 60068-2-6

1) For information about the area of use, see the EC declaration of conformity at: www.festo.com/catalogue/... → Support/Downloads.

If the devices are subject to usage restrictions in residential, commercial or light-industrial environments, further measures for the reduction of the emitted interference may be necessary.

Operating and environmental conditions	
Operating medium	Compressed air to ISO 8573-1:2010 [7:4:4]
Note on the operating/pilot medium	Lubricated operation possible (in which case lubricated operation will always be required)
Operating pressure	[MPa] -0.09 ... 1.6 [bar] -0.9 ... 16
Pilot pressure	[MPa] 0.3 ... 1 [bar] 3 ... 10
Ambient temperature	[°C] -5 ... +50
Temperature of medium	[°C] -5 ... +50
Relative humidity	[%] 0 ... 90
Certification	c UL us - Recognized (OL) C:Tick
Certificate-issuing authority	UL MH19482

Electrical data	
Electrical connection	Plug, square design according to EN 175301-803, type C, without PE conductor
Operating voltage	[V DC] 24 +10%/-15%
Characteristic coil data	[W] 1.8
Duty cycle	[%] 100
Signal status indication	Via accessories
Degree of protection to EN 60529	IP65, Nema 4 (in combination with plug socket)

Datasheet – Valve size 26 mm, valve with position detection

Electrical data – Sensor		VSVA-B-...P	VSVA-B-...C
Type		Plug, M8x1, 3-pin	Open cable end, 2.5 m
Operating voltage	[V DC]	10 ... 30	10 ... 30
Switching element function		N/C	N/C
Measuring principle		Inductive	Inductive
Sensor switching status indication		LED	LED
Reverse polarity protection		For all electrical connections	For all electrical connections
Short circuit current rating		Clocked	Clocked
No-load supply current	[mA]	max. 10	max. 10
Output current	[mA]	max. 200	max. 200
Switching frequency	[kHz]	max. 5	max. 5
Residual ripple	[%]	±10	±10
Voltage drop	[V]	max. 2	max. 2
Valve – Sensor switching time	On	60	60
	Off	11	11

Materials	
Housing	Die-cast aluminium, PA
Seals	FPM, NBR
Screws	Galvanised steel
Note on materials	RoHS-compliant
LABS (PWIS) conformity	VDMA24364-B1/B2-L

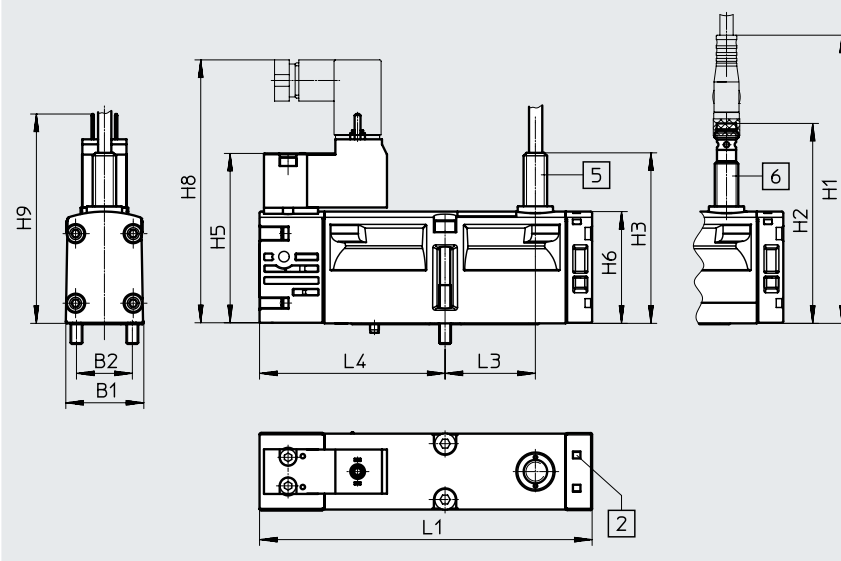

Dimensions

Download CAD data → www.festo.com

- [2] Slot for inscription label
- [5] Sensor with cable
- [6] Sensor with plug

	B1	B2	H1	H2	H3	H5	H6	H8	H9	L1	L3	L4
VSVA-B-M52-MZ-A1-1C1-A-...	26.2	19	98	68.2	58	57.8	38	89.6	71.2	113.1	30.7	63.1

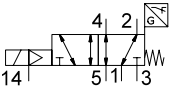
Datasheet – Valve size 26 mm, valve with position detection

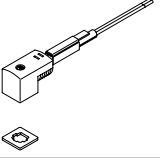
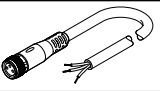
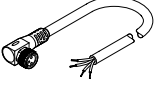
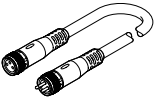
Ordering data – Pilot control fitted							
Code	Circuit symbol		Electrical connection for sensor	Part no.	Type		
5/2-way valve, single solenoid, with pilot control with square plug, type C to EN 175301-803							
SO		Inductive sensor with PNP output	Plug, M8x1, 3-pin	560726	VSVA-B-M52-MZ-A1-1C1-APP		
–			Open cable end, 2.5 m	560725	VSVA-B-M52-MZ-A1-1C1-APC		
SQ		Inductive sensor with NPN output	Plug, M8x1, 3-pin	560745	VSVA-B-M52-MZ-A1-1C1-ANP		
–			Open cable end, 2.5 m	560744	VSVA-B-M52-MZ-A1-1C1-ANC		
Ordering data – Accessories							
Code		Description		Part no.	Type		
Plug socket for plug pattern to EN 175301-803, type C							
–		Angled socket, type C, 3-pin, screw terminal	Cable fitting PG7	★ 151687	MSSD-EB		
			Cable fitting M12	539712	MSSD-EB-M12		
Illuminating seal for connection pattern to EN 175301-803, type C							
–		For plug socket MSSD, 12 ... 24 V DC		151717	MEB-LD-12-24DC		
Connecting cable for plug pattern to EN 175301-803, type C							
GG		Angled socket, type C, with LED Open end, 3-core	3-pin, cable sheath PVC	2.5 m	★ 151688	KMEB-1-24-2.5-LED	
GH				5 m	151689	KMEB-1-24-5-LED	
GJ				10 m	193457	KMEB-1-24-10-LED	
Connecting cable for electrical connection of the position detection sensor							
GM		Straight socket, M8x1, 3-pin Open end, 3-core		2.5 m	★ 541333	NEBU-M8G3-K-2.5-LE3	
GN				5 m	★ 541334	NEBU-M8G3-K-5-LE3	
GO		Angled socket, M8x1, 3-pin Open end, 3-core	–	2.5 m	★ 541338	NEBU-M8W3-K-2.5-LE3	
GP				5 m	★ 541341	NEBU-M8W3-K-5-LE3	
–				Rotatable socket	2.5 m	8001660	NEBU-M8R3-K-2.5-LE3
–					5 m	8001661	NEBU-M8R3-K-5-LE3
GQ		Straight socket, M8x1, 3-pin Straight plug M8x1, 4-pin		2.5 m	554037	NEBU-M8G3-K-2.5-M8G4	

Datasheet – Valve size 26 mm

-  - Flow rate
max. 924 l/min

-  - Voltage
24 V DC

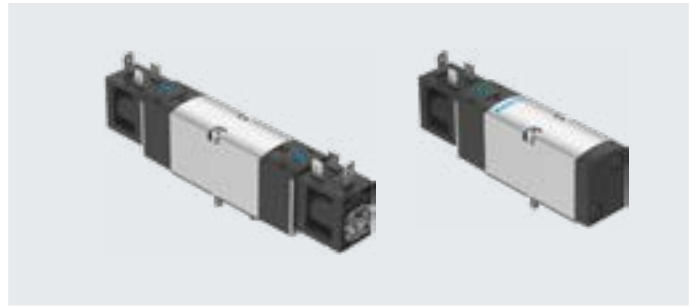

General technical data					
Valve function		5/2-way, single solenoid		5/2-way, double solenoid	5/3-way, exhausted
Reset method		Pneumatic spring	Mechanical spring	–	Mechanical spring
Design		Piston spool with sealing ring			
Overlap		Underlap			
Sealing principle		Soft			
Actuation type		Electrical			
Type of control		Piloted			
Pilot air supply		Internal			
Flow direction		Not reversible			
Exhaust air function		Can be throttled			
Manual override		Non-detenting; detenting			
Type of mounting		On sub-base			
Mounting position		Any			
Nominal size	[mm]	6.4			
Valve size	[mm]	26			
Pneumatic connection	1, 2, 3, 4, 5	Connecting plate size 26 mm to ISO 15407-1			
Port for venting hole		Not ducted			
b value		0.29	0.29	0.3	0.29
C value	[l/sbar]	3.94	3.98	3.92	3.99
Tightening torque for valve mounting	[Nm]	2.4			
Product weight	[g]	240	242	319	320
Conforms to		ISO 15407-1			

Flow rates					
Valve function		5/2-way, single solenoid		5/2-way, double solenoid	5/3-way, exhausted
Reset method		Pneumatic spring	Mechanical spring	–	Mechanical spring
Flow rate of valve	[l/min]	915	915	915	924
Flow rate of valve on individual sub-base	[l/min]	915	915	915	924
Flow rate of pneumatically linked valve	[l/min]	880	880	880	885
Standard nominal flow rate	[l/min]	900	900	900	900

Switching times					
Valve function		5/2-way, single solenoid		5/2-way, double solenoid	5/3-way, exhausted
Reset method		Pneumatic spring	Mechanical spring	–	Mechanical spring
Switching time on	[ms]	14.3	16.2	–	11.9
Switching time off	[ms]	25.2	22.8	–	36.2
Switching time changeover	[ms]	–	–	10.8	18.9

Datasheet – Valve size 26 mm

Safety data		
Max. positive test pulse with 0 signal	[μs]	2500
Max. negative test pulse with logic 1	[μs]	1100
Shock resistance		Shock test with severity level 2 in accordance with FN 942017-5 and EN 60068-2-27
Vibration resistance		Transport application test with severity level 2 to FN 942017-4 and EN 60068-2-6

Operating and environmental conditions		
Operating medium		Compressed air to ISO 8573-1:2010 [7:4:4]
Pilot medium		Compressed air to ISO 8573-1:2010 [7:4:4]
Note on the operating/pilot medium		Lubricated operation possible (in which case lubricated operation will always be required)
Operating pressure	[MPa]	0.3 ... 0.8
	[bar]	3 ... 8
Ambient temperature	[°C]	-5 ... +50
Temperature of medium	[°C]	-5 ... +50
Corrosion resistance class CRC ¹⁾		1 - Low corrosion stress

1) More information www.festo.com/x/topic/crc

Electrical data		
Electrical connection		Type B
		To industry standard (11 mm)
Nominal operating voltage	[V DC]	24
Characteristic coil data		24 V DC: 3.3 W
Permissible voltage fluctuations	[%]	±10
Duty cycle	[%]	100
Degree of protection		IP65
		With plug socket
		To IEC 60529
Signal status indication		Via accessories

Materials	
Housing	Wrought aluminium alloy
Seals	NBR, HNBR
Piston spool	Wrought aluminium alloy
Screws	Galvanised steel
Note on materials	RoHS-compliant
LABS (PWIS) conformity	VDMA24364 zone III

Datasheet – Valve size 26 mm

Dimensions

Download CAD data → www.festo.com

5/2-way single solenoid valve

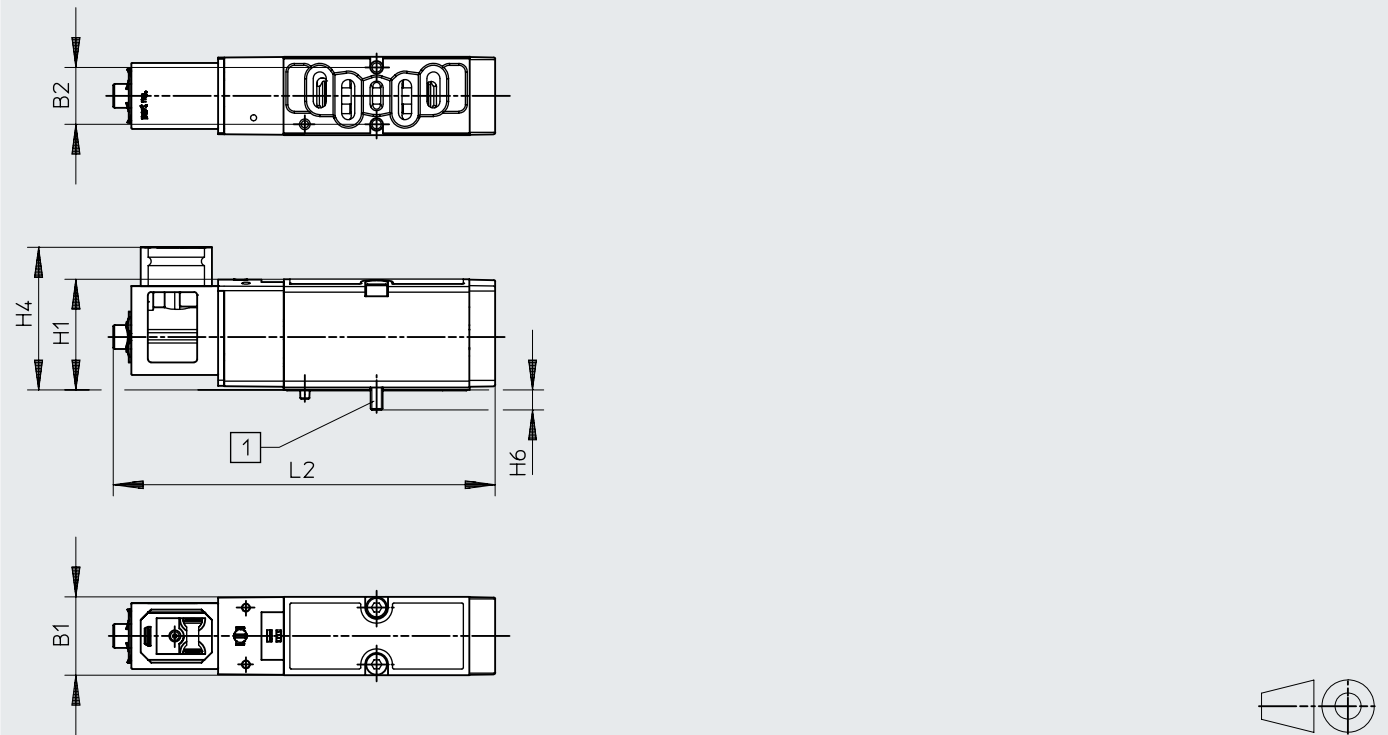

[1] Retaining screws M4

Type	B1	B2	H1	H4	H6	L1
VSVA-BK-M52...	26.2	19	37	47.7	6.7	127.7

Datasheet – Valve size 26 mm

Dimensions

Download CAD data → www.festo.com

5/2-way double solenoid valve and 5/3-way solenoid valve

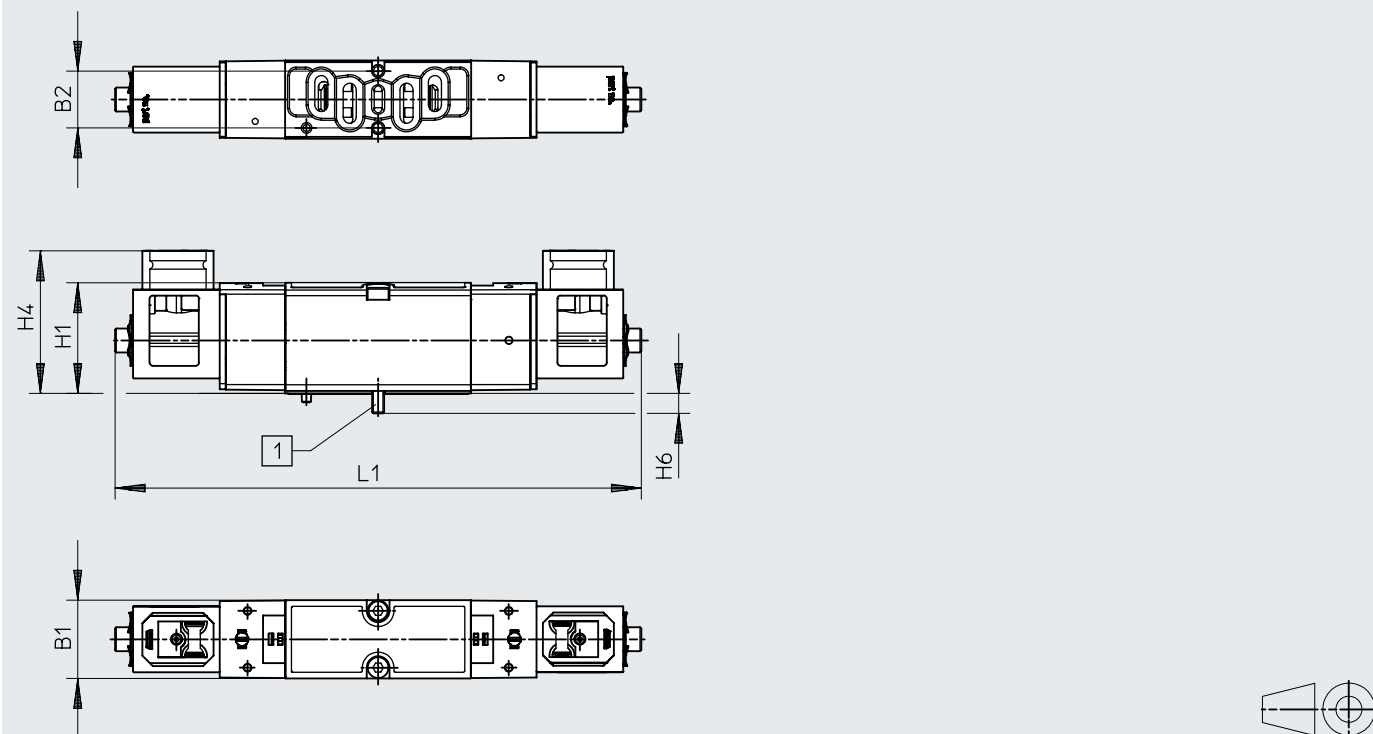

[1] Retaining screws M4

Type	B1	B2	H1	H4	H6	L1
VSVA-BK-B52...	26.1	19	37	47.7	6.7	176.1
VSVA-BK-P53...						

Ordering data

Code	Circuit symbol		Part no.	Type
5/2-way single solenoid valve				
-		Mechanical spring	Internal pilot air supply	8150869 VSVA-BK-M52-MD-A1-1B2
-		Pneumatic spring	Internal pilot air supply	8150870 VSVA-BK-M52-AD-A1-1B2
5/2-way valve, double solenoid				
-		-	Internal pilot air supply	8150871 VSVA-BK-B52-D-A1-1B2
5/3-way solenoid valve				
-		Normally exhausted	Internal pilot air supply	8150872 VSVA-BK-P53E-D-A1-1B2

Datasheet – Valve size 18 mm

-  - Flow rate
max. 750 l/min

-  - Voltage
24 V DC

**General technical data**

Valve function	2x 3/2-way valve	5/2-way valve	5/3-way valve	
Normal position	C ¹⁾ , U ²⁾ , H ⁴⁾	–	–	C ¹⁾ , U ²⁾ , E ³⁾
Stable position	Monostable		Bistable	Monostable
Pneumatic spring return	Yes	Yes	–	No
Mechanical spring return	No	Yes	–	Yes
Design	Piston spool			
Overlap	Positive overlap			
Sealing principle	Soft			
Actuation type	Electrical			
Type of control	Piloted			
Pilot air supply	Internal or external			
Flow direction	Not reversible	Reversible with external pilot air supply		
Exhaust air function	Can be throttled			
Manual override	Non-detenting			
Type of mounting	On sub-base			
Mounting position	Any			
Nominal size	[mm]	5		
Valve size	[mm]	18		
Ports on the sub-base	1, 2, 3, 4, 5 12, 14	G1/8 M5		
Tightening torque for valve mounting	[Nm]	0.9 ... 1.1		
Product weight	[g]	140		
Noise level	[dB (A)]	85		
Conforms to	ISO 15407-1, VDMA 24563			

1) C = Normally closed

2) U = Normally open

3) E = Normally exhausted

4) H = 2x 3/2-way valve in one housing with 1x normally closed and 1x normally open

Flow rates

Valve function	2x 3/2-way valve	5/2-way valve	5/3-way valve	
Flow rate of valve	[l/min]	600	750	650
Flow rate of valve on individual sub-base	[l/min]	450	550	500
Flow rate of pneumatically linked valve	[l/min]	400	550	450
Standard nominal flow rate	[l/min]	400	550	450

Switching times [ms]

	Switching time on	Switching time off	Switching time changeover	Switching time changeover (dominant)
2x 3/2-way valve	10	22	–	–
5/2-way valve	Pneumatic spring	20	25	–
	Mechanical spring	12	34	–
5/2-way valve, double solenoid	–	–	10	10
5/3-way valve	15	36	–	–

Datasheet – Valve size 18 mm

Safety data		
Type	VSVA-B-...-A2-1R...	VSVA-B-T32C-AZH-A2-1R2L VSVA-B-T32U-AZH-A2-1R2L VSVA-B-T32H-AZH-A2-1R2L VSVA-B-T32U-AH-A2-1R5L
CE marking (see declaration of conformity)	To EU EMC Directive ¹⁾	To EU EMC Directive ¹⁾
UKCA marking (see declaration of conformity) ¹⁾	To UK EMC regulations	–
	To UK RoHS regulations	–
Max. positive test pulse with logic 0	[µs] 500	500
Max. negative test pulse with logic 1	[µs] 500	500
Shock resistance	Shock test with severity level 2 in accordance with FN 942017-5 and EN 60068-2-27	Shock test with severity level 2 in accordance with FN 942017-5 and EN 60068-2-27
Vibration resistance	Transport application test with severity level 2 to FN 942017-4 and EN 60068-2-6	Transport application test with severity level 2 to FN 942017-4 and EN 60068-2-6

1) For information about the area of use, see the EC declaration of conformity at: www.festo.com/catalogue/... → Support/Downloads.

If the devices are subject to usage restrictions in residential, commercial or light-industrial environments, further measures for the reduction of the emitted interference may be necessary.

Operating and environmental conditions					
Valve function		2x 3/2-way valve	5/2-way valve	5/3-way valve	
Operating medium		Compressed air to ISO 8573-1:2010 [7:4:4]			
Note on the operating/pilot medium		Lubricated operation possible (in which case lubricated operation will always be required)			
Operating pressure	Internal pilot air supply	[MPa]	0.3 ... 0.8	0.3 ... 0.8	
		[bar]	3 ... 8	3 ... 8	
	External pilot air supply	[MPa]	0.3 ... 1	–0.09 ... 1	–0.09 ... 1
		[bar]	3 ... 10	–0.9 ... 10	–0.9 ... 10
Pilot pressure	[MPa]	0.3 ... 0.8	0.3 ... 0.8	0.3 ... 0.8	
	[bar]	3 ... 8	3 ... 8	3 ... 8	
Ambient temperature	[°C]	–5 ... +50			
Temperature of medium	[°C]	–5 ... +50			
Relative humidity	[%]	0 ... 90			
Corrosion resistance class CRC ¹⁾		2			
Certification		c UL us - Recognized (OL)			
		C-Tick			

1) More information www.festo.com/x/topic/crc

Electrical data		
Electrical connection		Central plug, round design, M8x1 4-pin or M12x1 3-pin
Characteristic coil data	Voltage	[V DC] 24±10% = 21.6 ... 26.4
	Power	[W] High-current phase: 2.4 Low-current phase: 1 ¹⁾
Duty cycle	[%]	100
Degree of protection to EN 60529		IP65 (in combination with plug socket)
Signal status indication		LED
Reverse polarity protection		For all electrical connections
Additional functions		Holding current reduction
		Safety shut-off
Protection against direct and indirect contact		PELV

1) Controlled by integrated current reduction

Datasheet – Valve size 18 mm

Materials	
Housing	Die-cast aluminium, POM
Seals	NBR
Note on materials	RoHS-compliant
LABS (PWIS) conformity	VDMA24364-B1/B2-L

Dimensions

Download CAD data → www.festo.com

Valve with central plug M8x1, VSVA-B-...-1R2L

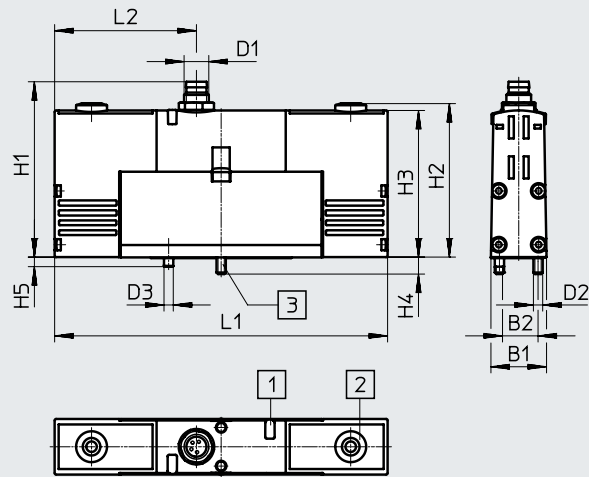

- [1] Light emitting diode
- [2] Manual override
- [3] Captive retaining screws

Valve with central plug M12x1, VSVA-B-...-1R5L

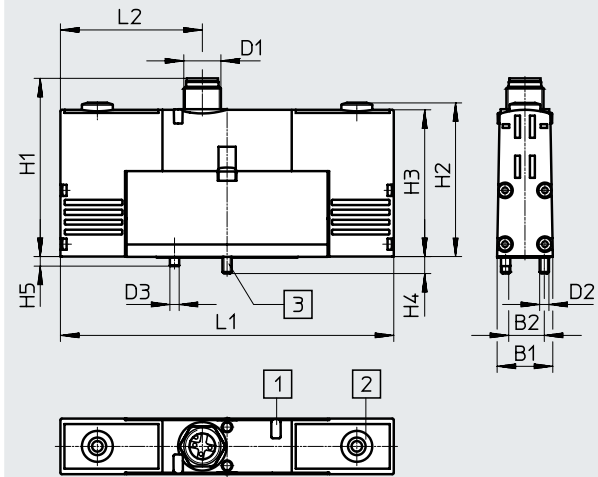

- [1] Light emitting diode
- [2] Manual override
- [3] Captive retaining screws

Type	B1	B2	D1	D2	D3	H1	H2	H3	H4	H5	L1	L2
VSVA-B-...-1R2L	18	12.5	M8x1	M3	3	54.4	49.8	47.6	5.4	3	107.8	46.9
VSVA-B-...-1R5L			M12x1			58.2						

Terminal allocation

M8x1

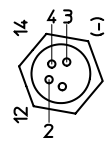

- 1 Unused
- 2 Signal (+) solenoid 12/10
- 3 com (-)
- 4 Signal (+) solenoid 14/10

M12x1

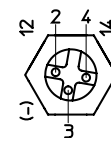

- 2 Signal (+) solenoid 12
- 3 com (-)
- 4 Signal (+) solenoid 14

Datasheet – Valve size 18 mm

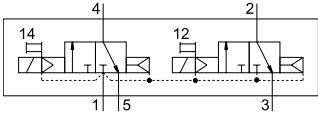
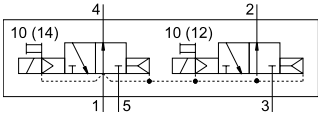
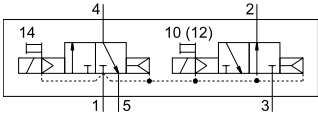
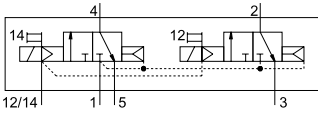
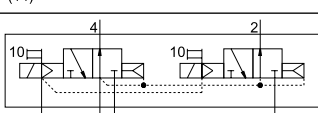
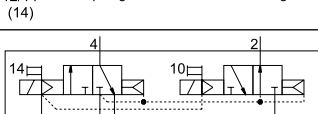
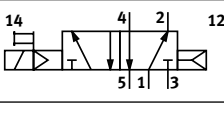
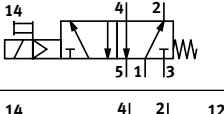
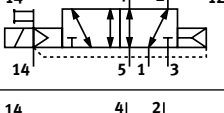
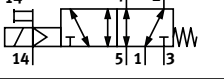
Ordering data				Part no.	Type	
Code	Circuit symbol					
2x 3/2-way solenoid valve						
K		Normal position: 2x normally closed	Internal pilot air supply	M8x1	534771	VSVA-B-T32C-AH-A2-1R2L
				M12x1	546764	VSVA-B-T32C-AH-A2-1R5L
N		Normal position: 2x normally open	Internal pilot air supply	M8x1	534772	VSVA-B-T32U-AH-A2-1R2L
				M12x1	546765	VSVA-B-T32U-AH-A2-1R5L
H		Normal position: 1x normally closed 1x normally open	Internal pilot air supply	M8x1	534773	VSVA-B-T32H-AH-A2-1R2L
				M12x1	546766	VSVA-B-T32H-AH-A2-1R5L
K		Normal position: 2x normally closed	External pilot air supply	M8x1	534781	VSVA-B-T32C-AZH-A2-1R2L
				M12x1	546774	VSVA-B-T32C-AZH-A2-1R5L
N		Normal position: 2x normally open	External pilot air supply	M8x1	534782	VSVA-B-T32U-AZH-A2-1R2L
				M12x1	546775	VSVA-B-T32U-AZH-A2-1R5L
H		Normal position: 1x normally closed 1x normally open	External pilot air supply	M8x1	534783	VSVA-B-T32H-AZH-A2-1R2L
				M12x1	546776	VSVA-B-T32H-AZH-A2-1R5L
5/2-way single solenoid valve						
M		Pneumatic spring	Internal pilot air supply	M8x1	534774	VSVA-B-M52-AH-A2-1R2L
				M12x1	546767	VSVA-B-M52-AH-A2-1R5L
O		Mechanical spring	Internal pilot air supply	M8x1	534775	VSVA-B-M52-MH-A2-1R2L
				M12x1	546768	VSVA-B-M52-MH-A2-1R5L
M		Pneumatic spring	External pilot air supply	M8x1	534784	VSVA-B-M52-AZH-A2-1R2L
				M12x1	546777	VSVA-B-M52-AZH-A2-1R5L
O		Mechanical spring	External pilot air supply	M8x1	534785	VSVA-B-M52-MZH-A2-1R2L
				M12x1	546778	VSVA-B-M52-MZH-A2-1R5L

Datasheet – Valve size 18 mm

Ordering data				Part no.	Type
Code	Circuit symbol				
5/2-way valve, double pilot					
J		Dominant 1st signal	Internal pilot air supply	M8x1	534776 VSVA-B-B52-H-A2-1R2L
				M12x1	546769 VSVA-B-B52-H-A2-1R5L
D		Dominant at 14	Internal pilot air supply	M8x1	534777 VSVA-B-D52-H-A2-1R2L
				M12x1	546770 VSVA-B-D52-H-A2-1R5L
J		Dominant 1st signal	External pilot air supply	M8x1	534786 VSVA-B-B52-ZH-A2-1R2L
				M12x1	546779 VSVA-B-B52-ZH-A2-1R5L
D		Dominant at 14	External pilot air supply	M8x1	534787 VSVA-B-D52-ZH-A2-1R2L
				M12x1	546780 VSVA-B-D52-ZH-A2-1R5L
5/3-way solenoid valve					
G		Normally closed	Internal pilot air supply	M8x1	534778 VSVA-B-P53C-H-A2-1R2L
				M12x1	546771 VSVA-B-P53C-H-A2-1R5L
B		Normally open	Internal pilot air supply	M8x1	534780 VSVA-B-P53U-H-A2-1R2L
				M12x1	546773 VSVA-B-P53U-H-A2-1R5L
E		Normally exhausted	Internal pilot air supply	M8x1	534779 VSVA-B-P53E-H-A2-1R2L
				M12x1	546772 VSVA-B-P53E-H-A2-1R5L
G		Normally closed	External pilot air supply	M8x1	534788 VSVA-B-P53C-ZH-A2-1R2L
				M12x1	546781 VSVA-B-P53C-ZH-A2-1R5L
B		Normally open	External pilot air supply	M8x1	534790 VSVA-B-P53U-ZH-A2-1R2L
				M12x1	546783 VSVA-B-P53U-ZH-A2-1R5L
E		Normally exhausted	External pilot air supply	M8x1	534789 VSVA-B-P53E-ZH-A2-1R2L
				M12x1	546782 VSVA-B-P53E-ZH-A2-1R5L

Solenoid valves VSVA, with central plug M8x1, M12x1

Datasheet – Valve size 26 mm

-  - Flow rate
max. 1400 l/min

-  - Voltage
24 V DC



General technical data

Valve function	2x 3/2-way valve			5/2-way valve		5/3-way valve		
	C ¹⁾	U ²⁾	H ⁴⁾	–	–	C ¹⁾	U ²⁾	E ³⁾
Normal position	C ¹⁾	U ²⁾	H ⁴⁾	–	–	C ¹⁾	U ²⁾	E ³⁾
Stable position	Monostable			Monostable	Bistable	Monostable		
Pneumatic spring return	Yes			Yes	–	No		
Mechanical spring return	No			Yes	–	Yes		
Design	Piston spool							
Overlap	Positive overlap							
Sealing principle	Soft							
Actuation type	Electrical							
Type of control	Piloted							
Pilot air supply	Internal or external							
Flow direction	Not reversible			Reversible with external pilot air supply				
Exhaust air function	Can be throttled, via throttle plate, via individual sub-base							
Manual override	Non-detenting							
Type of mounting	On sub-base							
Mounting position	Any							
Nominal size [mm]	9							
Valve size [mm]	26							
Ports on the sub-base	1, 2, 3, 4, 5 12, 14			G1/4 M5				
b value	0.25	–	–	0.25	–	0.24	–	0.3
c value [l/sbar]	4	–	–	4.5	–	4.35	–	2.9
Tightening torque for valve mounting [Nm]	1.8 ... 2.2							
Product weight [g]	270							
Conforms to	ISO 15407-1							

- 1) C = Normally closed
- 2) U = Normally open
- 3) E = Normally exhausted
- 4) H=2x 3/2-way valve in one housing with 1x normally closed and 1x normally open

Flow rates

Valve function	2x 3/2-way valve	5/2-way valve	5/3-way valve
Flow rate of valve [l/min]	1250	1400	1400
Flow rate of valve on individual sub-base [l/min]	1000	1100	1100
Flow rate of pneumatically linked valve [l/min]	900	1100	1000
Standard nominal flow rate [l/min]	900	1100	1000

Switching times [ms]

	Switching time on	Switching time off	Switching time changeover	Switching time changeover (dominant)
2x 3/2-way valve	20	33	–	–
5/2-way valve	Pneumatic spring	25	40	–
	Mechanical spring	20	52	–
5/2-way valve, double solenoid	–	–	15	25
5/3-way valve	20	52	–	–

Datasheet – Valve size 26 mm

Safety data		
CE marking (see declaration of conformity)		To EU EMC Directive ¹⁾
UKCA marking (see declaration of conformity) ¹⁾		To UK EMC regulations
		To UK RoHS regulations
Max. positive test pulse with logic 0	[μ s]	400
Max. negative test pulse with logic 1	[μ s]	100
Shock resistance		Shock test with severity level 2 in accordance with FN 942017-5 and EN 60068-2-27
Vibration resistance		Transport application test with severity level 2 to FN 942017-4 and EN 60068-2-6

1) For information about the area of use, see the EC declaration of conformity at: www.festo.com/catalogue/... → Support/Downloads.

If the devices are subject to usage restrictions in residential, commercial or light-industrial environments, further measures for the reduction of the emitted interference may be necessary.

Operating and environmental conditions			2x 3/2-way valve	5/2-way valve	5/3-way valve
Valve function					
Operating medium			Compressed air to ISO 8573-1:2010 [7:4:4]		
Pilot medium			Compressed air to ISO 8573-1:2010 [7:4:4]		
Note on the operating/pilot medium			Lubricated operation possible (in which case lubricated operation will always be required)		
Operating pressure	Internal pilot air supply	[MPa]	0.3 ... 0.8	0.3 ... 0.8	0.3 ... 0.8
		[bar]	3 ... 8	3 ... 8	3 ... 8
	External pilot air supply	[MPa]	0.3 ... 1	-0.09 ... 1.6	-0.09 ... 1.6
		[bar]	3 ... 10	-0.9 ... 16	-0.9 ... 16
Pilot pressure ¹⁾		[MPa]	0.3 ... 0.8	0.3 ... 0.8	0.3 ... 0.8
		[bar]	3 ... 8	3 ... 8	3 ... 8
Ambient temperature		[°C]	-5 ... +50		
Temperature of medium		[°C]	-5 ... +50		
Relative humidity		[%]	0 ... 90		
Corrosion resistance class CRC ²⁾			2		
Certification			c UL us - Recognized (OL)		
			RCM		

1) Pilot pressure dependent on operating pressure → graph

2) More information www.festo.com/x/topic/crc

Minimum pilot pressure p₁₂, p₁₄ as a function of operating pressure p₁ (external pilot air supply)

2x 3/2-way valve

5/2-way valve and 5/3-way valve

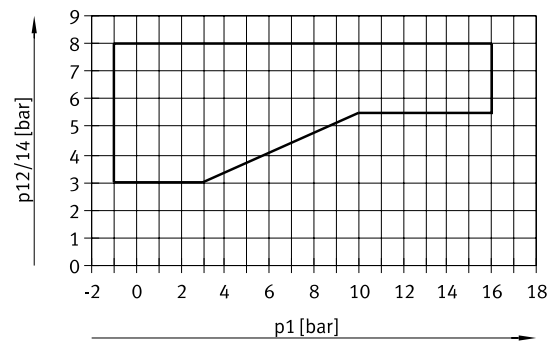
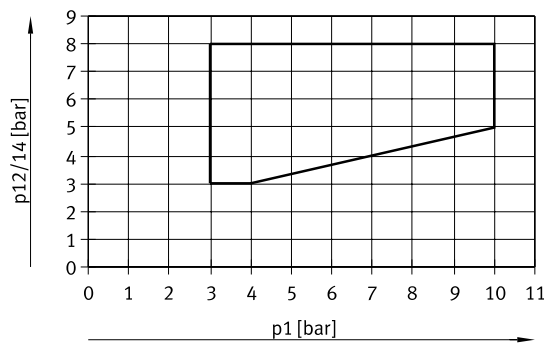

Datasheet – Valve size 26 mm

Electrical data		
Electrical connection		Central plug, round design, M8x1 4-pin or M12x1 3-pin
Characteristic coil data	Voltage	[V DC] 24±10% = 21.6 ... 26.4
	Power	[W] High-current phase: 2.4 Low-current phase: 1 ¹⁾
Nominal pick-up current per solenoid coil		[mA] 110 to 20 ms
Nominal current with current reduction		[mA] 30 after 20 ms
Duty cycle		[%] 100
Degree of protection to EN 60529		IP65, Nema 4 (in combination with plug socket)
Signal status indication		LED
Reverse polarity protection		For all electrical connections
Additional functions		Holding current reduction Safety shut-off
Protection against direct and indirect contact		PELV

1) Controlled by integrated current reduction

Materials	
Housing	Die-cast aluminium, POM
Seals	HNBR, NBR, FPM
Note on materials	RoHS-compliant
LABS (PWIS) conformity	VDMA24364-B1/B2-L

Dimensions Download CAD data → www.festo.com

Valve with central plug M8x1, VSVA-B-...-1R2L

[1] Light emitting diode [3] Captive retaining screws
[2] Manual override

Valve with central plug M12x1, VSVA-B-...-1R5L

[1] Light emitting diode [3] Captive retaining screws
[2] Manual override

Type	B1	B2	D1	D2	D3	H1	H2	H3	H4	H5	L1	L2	L3
VSVA-B-...-1R2L	26.3	19	M8x1	M4	3	63.3	59.2	56.6	6	3	112.5	110.7	46.5
VSVA-B-...-1R5L			M12x1			66.6							

Terminal allocation



M8x1

1 Unused
2 Signal (+) solenoid 12/10
3 com (-)
4 Signal (+) solenoid 14/10

M12x1

2 Signal (+) solenoid 12
3 com (-)
4 Signal (+) solenoid 14

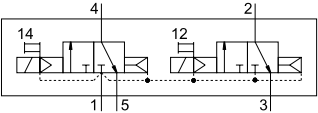
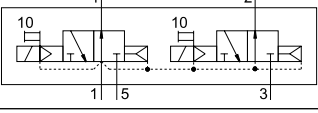
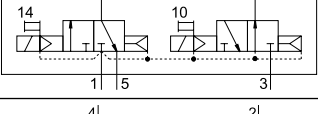
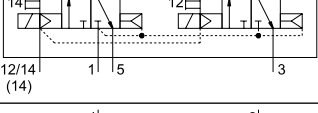
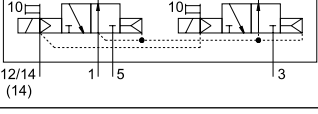
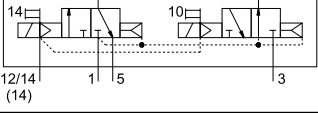
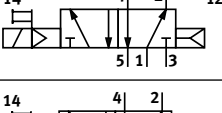
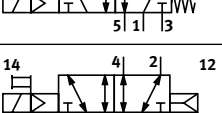
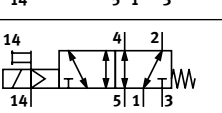
Datasheet – Valve size 26 mm

Ordering data				Part no.	Type	
Code	Circuit symbol					
2x 3/2-way solenoid valve						
K		Normal position: 2x normally closed	Internal pilot air supply	M8x1	534532	VSVA-B-T32C-AH-A1-1R2L
				M12x1	534552	VSVA-B-T32C-AH-A1-1R5L
N		Normal position: 2x normally open	Internal pilot air supply	M8x1	534533	VSVA-B-T32U-AH-A1-1R2L
				M12x1	534553	VSVA-B-T32U-AH-A1-1R5L
H		Normal position: 1x normally closed 1x normally open	Internal pilot air supply	M8x1	534534	VSVA-B-T32H-AH-A1-1R2L
				M12x1	534554	VSVA-B-T32H-AH-A1-1R5L
K		Normal position: 2x normally closed	External pilot air supply	M8x1	534522	VSVA-B-T32C-AZH-A1-1R2L
				M12x1	534542	VSVA-B-T32C-AZH-A1-1R5L
N		Normal position: 2x normally open	External pilot air supply	M8x1	534523	VSVA-B-T32U-AZH-A1-1R2L
				M12x1	534543	VSVA-B-T32U-AZH-A1-1R5L
H		Normal position: 1x normally closed 1x normally open	External pilot air supply	M8x1	534524	VSVA-B-T32H-AZH-A1-1R2L
				M12x1	534544	VSVA-B-T32H-AZH-A1-1R5L
5/2-way single solenoid valve						
M		Pneumatic spring	Internal pilot air supply	M8x1	534535	VSVA-B-M52-AH-A1-1R2L
				M12x1	534555	VSVA-B-M52-AH-A1-1R5L
O		Mechanical spring	Internal pilot air supply	M8x1	534536	VSVA-B-M52-MH-A1-1R2L
				M12x1	534556	VSVA-B-M52-MH-A1-1R5L
M		Pneumatic spring	External pilot air supply	M8x1	534525	VSVA-B-M52-AZH-A1-1R2L
				M12x1	534545	VSVA-B-M52-AZH-A1-1R5L
O		Mechanical spring	External pilot air supply	M8x1	534526	VSVA-B-M52-MZH-A1-1R2L
				M12x1	534546	VSVA-B-M52-MZH-A1-1R5L

Datasheet – Valve size 26 mm

Ordering data				Part no.	Type
Code	Circuit symbol				
5/2-way valve, double pilot					
J		Dominant 1st signal	Internal pilot air supply	M8x1	534537 VSVA-B-B52-H-A1-1R2L
				M12x1	534557 VSVA-B-B52-H-A1-1R5L
D		Dominant at 14	Internal pilot air supply	M8x1	534538 VSVA-B-D52-H-A1-1R2L
				M12x1	534558 VSVA-B-D52-H-A1-1R5L
J		Dominant 1st signal	External pilot air supply	M8x1	534527 VSVA-B-B52-ZH-A1-1R2L
				M12x1	534547 VSVA-B-B52-ZH-A1-1R5L
D		Dominant at 14	External pilot air supply	M8x1	534528 VSVA-B-D52-ZH-A1-1R2L
				M12x1	534548 VSVA-B-D52-ZH-A1-1R5L
5/3-way solenoid valve					
G		Normally closed	Internal pilot air supply	M8x1	534539 VSVA-B-P53C-H-A1-1R2L
				M12x1	534559 VSVA-B-P53C-H-A1-1R5L
B		Normally open	Internal pilot air supply	M8x1	534541 VSVA-B-P53U-H-A1-1R2L
				M12x1	534561 VSVA-B-P53U-H-A1-1R5L
E		Normally exhausted	Internal pilot air supply	M8x1	534540 VSVA-B-P53E-H-A1-1R2L
				M12x1	534560 VSVA-B-P53E-H-A1-1R5L
G		Normally closed	External pilot air supply	M8x1	534529 VSVA-B-P53C-ZH-A1-1R2L
				M12x1	534549 VSVA-B-P53C-ZH-A1-1R5L
B		Normally open	External pilot air supply	M8x1	534531 VSVA-B-P53U-ZH-A1-1R2L
				M12x1	534551 VSVA-B-P53U-ZH-A1-1R5L
E		Normally exhausted	External pilot air supply	M8x1	534530 VSVA-B-P53E-ZH-A1-1R2L
				M12x1	534550 VSVA-B-P53E-ZH-A1-1R5L

Datasheet – Valve size 18 mm

-  - Flow rate
550 ... 750 l/min

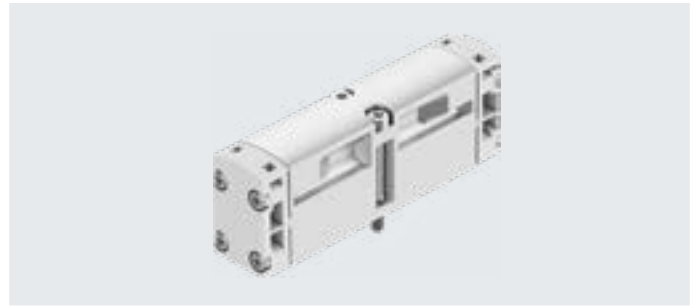

General technical data				
Valve function	2x 3/2-way valve	5/2-way valve		5/3-way valve
Normal position	C ¹⁾ , U ²⁾ , H ⁴⁾	–		C ¹⁾ , U ²⁾ , E ³⁾
Stable position	Monostable	Monostable	Bistable	Monostable
Pneumatic spring return	Yes	Yes	–	No
Mechanical spring return	No	Yes	–	Yes
Design	Piston spool			
Overlap	Positive overlap			
Sealing principle	Soft			
Actuation type	Pneumatic			
Type of control	Direct			
Flow direction	Not reversible	Reversible	Reversible	Reversible
Exhaust air function	Can be throttled			
Type of mounting	On sub-base			
Mounting position	Any			
Nominal size [mm]	5			
Valve size [mm]	18			
Ports on the sub-base	1, 2, 3, 4, 5 12, 14	G1/8		M5
Tightening torque for valve mounting [Nm]	0.9 ... 1.1			
Product weight [g]	80			
Conforms to	ISO 15407-1, VDMA 24563			

- 1) C = Normally closed
 2) U = Normally open
 3) E = Normally exhausted
 4) H=2x 3/2-way valve in one housing with 1x normally closed and 1x normally open

Flow rates				
Valve function	2x 3/2-way valve	5/2-way valve		5/3-way valve
		Single solenoid	Double solenoid	
Flow rate of valve [l/min]	600	750	750	650
Flow rate of valve on individual sub-base [l/min]	450	550	550	500
Flow rate of pneumatically linked valve [l/min]	400	550	550	450
Standard nominal flow rate [l/min]	400	550	550	450

Switching times [ms]				
	Switching time on	Switching time off	Switching time changeover	Switching time changeover (dominant)
2x 3/2-way valve	10	15	–	–
5/2-way valve	Pneumatic spring	11	20	–
	Mechanical spring	8	18	–
5/2-way valve, double solenoid	–	–	6	6
5/3-way valve	9	18	–	–

Datasheet – Valve size 18 mm

Operating and environmental conditions		2x 3/2-way valve	5/2-way valve Single solenoid	5/2-way valve Double solenoid	5/3-way valve
Valve function					
Operating medium		Compressed air to ISO 8573-1:2010 [7:4:4]			
Pilot medium		Compressed air to ISO 8573-1:2010 [7:4:4]			
Note on the operating/pilot medium		Lubricated operation possible (in which case lubricated operation will always be required)			
Operating pressure	With pneumatic spring [bar]	2 ... 10	2 ... 10	-0.9 ... 10	-
	With mechanical spring [bar]	-	-0.9 ... 10	-	-0.9 ... 10
Pilot pressure	With pneumatic spring [bar]	2 ... 10	2 ... 10	2 ... 10	-
	With mechanical spring [bar]	-	3 ... 10	-	3 ... 10
Ambient temperature	[°C]	-10 ... +60			
Temperature of medium	[°C]	-10 ... +60			
Relative humidity	[%]	0 ... 90			

Materials	
Housing	Die-cast aluminium
Seals	NBR
Screws	Galvanised steel
Note on materials	RoHS-compliant
LABS (PWIS) conformity	VDMA24364-B1/B2-L

Dimensions

Download CAD data → www.festo.com

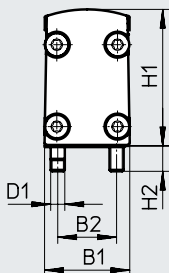
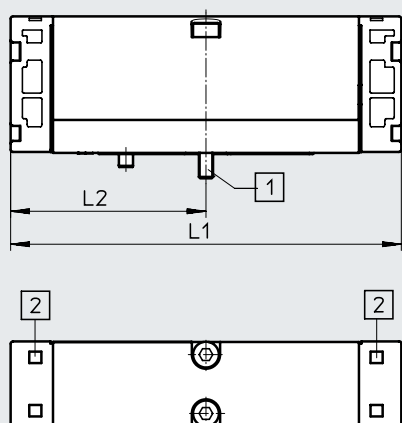

[1] Captive screws

[2] Slot for inscription label

Type	B1	B2	D1	H1	H2	L1	L2
VSPA-B	18	12.5	M3	29	5.4	83	41.5

Datasheet – Valve size 18 mm

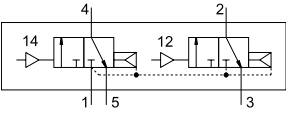
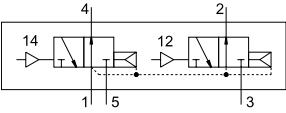
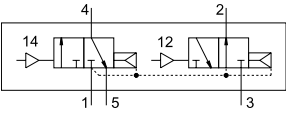
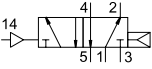
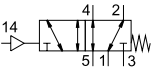
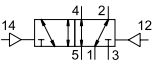
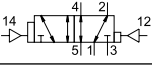
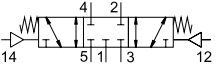
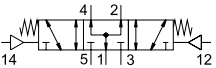
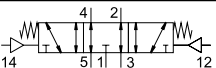
Ordering data		Part no.	Type
Code	Circuit symbol		
2x 3/2-way pneumatic valve			
K		2x normally closed	546721 VSPA-B-T32C-A2
N		2x normally open	546722 VSPA-B-T32U-A2
H		Normal position: 1x normally closed 1x normally open	546723 VSPA-B-T32H-A2
5/2-way pneumatic valve, monostable			
M		Pneumatic spring	546726 VSPA-B-M52-A-A2
O		Mechanical spring	546727 VSPA-B-M52-M-A2
5/2-way pneumatic valve, bistable			
J		Dominant 1st signal	546724 VSPA-B-B52-A2
D		Dominant at 14	546725 VSPA-B-D52-A2
5/3-way pneumatic valve			
G		Normally closed	546730 VSPA-B-P53C-A2
B		Normally open	546728 VSPA-B-P53U-A2
E		Normally exhausted	546729 VSPA-B-P53E-A2

Datasheet – Valve size 26 mm

 Flow rate
 1250 ... 1400 l/min



General technical data		2x 3/2-way valve		5/2-way valve		5/3-way valve	
Valve function							
Normal position		C ¹⁾ , U ²⁾ , H ⁴⁾		–		C ¹⁾ , U ²⁾ , E ³⁾	
Stable position		Monostable		Monostable		Bistable	
Pneumatic spring return		Yes		Yes		–	
Mechanical spring return		No		Yes		–	
Design		Piston spool					
Overlap		Positive overlap					
Sealing principle		Soft					
Actuation type		Pneumatic					
Type of control		Direct					
Flow direction		Not reversible		Reversible		Reversible	
Exhaust air function		Can be throttled					
Type of mounting		On sub-base					
Mounting position		Any					
Nominal size	[mm]	9					
Valve size	[mm]	26					
Ports on the sub-base		1, 2, 3, 4, 5		G1/4			
		12, 14		M5			
Tightening torque for valve mounting	[Nm]	1.8 ... 2.2					
Product weight	[g]	180					
Conforms to		ISO 15407-1, VDMA 24563					

- 1) C = Normally closed
- 2) U = Normally open
- 3) E = Normally exhausted
- 4) H=2x 3/2-way valve in one housing with 1x normally closed and 1x normally open

Flow rates		2x 3/2-way valve		5/2-way valve		5/3-way valve	
Valve function				Single solenoid		Double solenoid	
Flow rate of valve	[l/min]	1250		1400		1400	
Flow rate of valve on individual sub-base	[l/min]	1000		1100		1100	
Flow rate of pneumatically linked valve	[l/min]	900		1100		1000	
Standard nominal flow rate	[l/min]	900		1100		1000	

Switching times [ms]		Switching time on		Switching time off		Switching time changeover	
						Switching time changeover (dominant)	
2x 3/2-way valve		15		28		–	
5/2-way valve		Pneumatic spring		18		30	
		Mechanical spring		10		35	
5/2-way valve, double solenoid		–		–		10	
5/3-way valve		13		32		–	

Datasheet – Valve size 26 mm

Operating and environmental conditions			2x 3/2-way valve	5/2-way valve Single solenoid	5/2-way valve Double solenoid	5/3-way valve
Valve function						
Operating medium			Compressed air to ISO 8573-1:2010 [7:4:4]			
Pilot medium			Compressed air to ISO 8573-1:2010 [7:4:4]			
Note on the operating/pilot medium			Lubricated operation possible (in which case lubricated operation will always be required)			
Operating pressure	With pneumatic spring	[bar]	2 ... 10	2 ... 10	-0.9 ... 16	-
	With mechanical spring	[bar]	-	-0.9 ... 16	-	-0.9 ... 16
Pilot pressure	With pneumatic spring	[bar]	2 ... 10	2 ... 10	2 ... 10	-
	With mechanical spring	[bar]	-	3 ... 10	-	3 ... 10
Ambient temperature		[°C]	-10 ... +60			
Temperature of medium		[°C]	-10 ... +60			
Relative humidity		[%]	0 ... 90			

Materials

Housing	Die-cast aluminium
Seals	NBR
Screws	Galvanised steel
Note on materials	RoHS-compliant
LABS (PWIS) conformity	VDMA24364-B1/B2-L

Dimensions

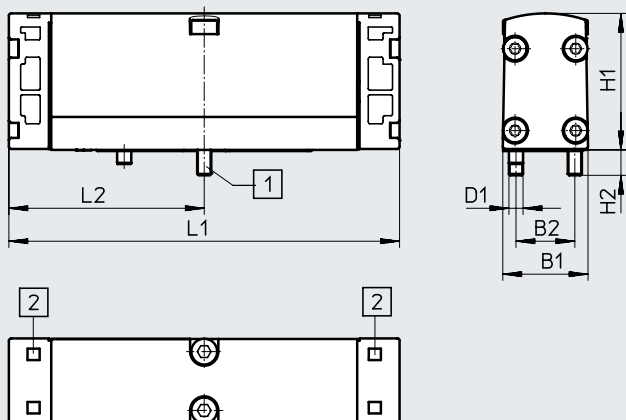
Download CAD data → www.festo.com

[1] Captive screws

[2] Slot for inscription label

	B1	B2	D1	H1	H2	L1	L2
VSPA-B	26.2	19	M4	38	7	100	50

Datasheet – Valve size 26 mm

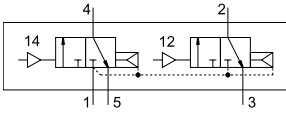
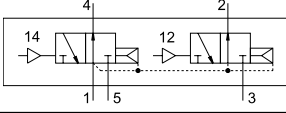
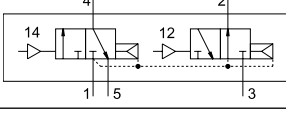
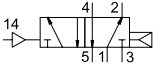
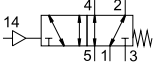
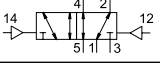
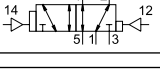
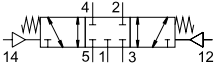
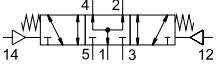
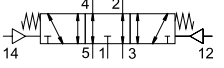
Ordering data		Part no.	Type
Code	Circuit symbol		
2x 3/2-way pneumatic valve			
K		2x normally closed	546711 VSPA-B-T32C-A1
N		2x normally open	546712 VSPA-B-T32U-A1
H		Normal position: 1x normally closed 1x normally open	546713 VSPA-B-T32H-A1
5/2-way pneumatic valve, monostable			
M		Pneumatic spring	546716 VSPA-B-M52-A-A1
O		Mechanical spring	546717 VSPA-B-M52-M-A1
5/2-way pneumatic valve, bistable			
J		Dominant 1st signal	546714 VSPA-B-B52-A1
D		Dominant at 14	546715 VSPA-B-D52-A1
5/3-way pneumatic valve			
G		Normally closed	546720 VSPA-B-P53C-A1
B		Normally open	546718 VSPA-B-P53U-A1
E		Normally exhausted	546719 VSPA-B-P53E-A1

Vertical stacking

Regulator plate

VABF-S3-2-R

VABF-S3-1-R

-  - Temperature range
-5 ... +50 °C

-  - Input pressure
0.5 ... 10 bar

Pressure regulation ranges:

- 0.05 ... 0.6 MPa
- 0.05 ... 0.85 MPa
- 0.2 ... 0.6 MPa
- 0.2 ... 0.85 MPa

Output pressure constant with secondary venting

Material:

Housing: Die-cast aluminium

Control section: PA

Note on materials:

RoHS-compliant

LABS (PWIS) conformity:

VDMA24364-B1/B2-L

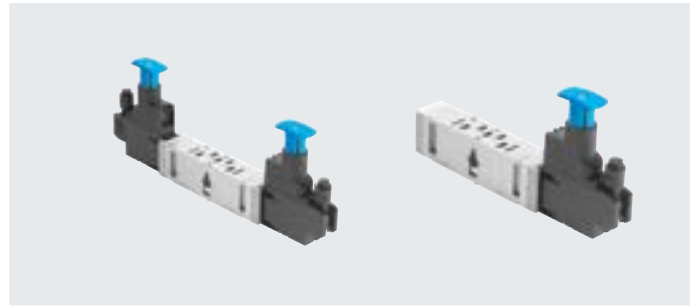

General technical data	
Based on norm	ISO 15407-1
Mounting position	Any
Regulator function	Output pressure constant With secondary exhausting
Type of mounting for vertical stacking	On manifold sub-base On individual sub-base
Optional pressure gauge	possible
Pressure gauge connection	With retaining clamp
Input pressure 1	[bar] 0.5 ... 10
Operating and environmental conditions	
Operating medium	Compressed air to ISO 8573-1:2010 [7:4:4]
Note on the operating/pilot medium	Lubricated operation possible (in which case lubricated operation will always be required)
Ambient temperature	[°C] -5 ... +50
Corrosion resistance class CRC ¹⁾	0 - no corrosion stress
Degree of protection	IP65 NEMA 4

1) More information www.festo.com/x/topic/crc

Vertical stacking

Dimensions

Download CAD data → www.festo.com

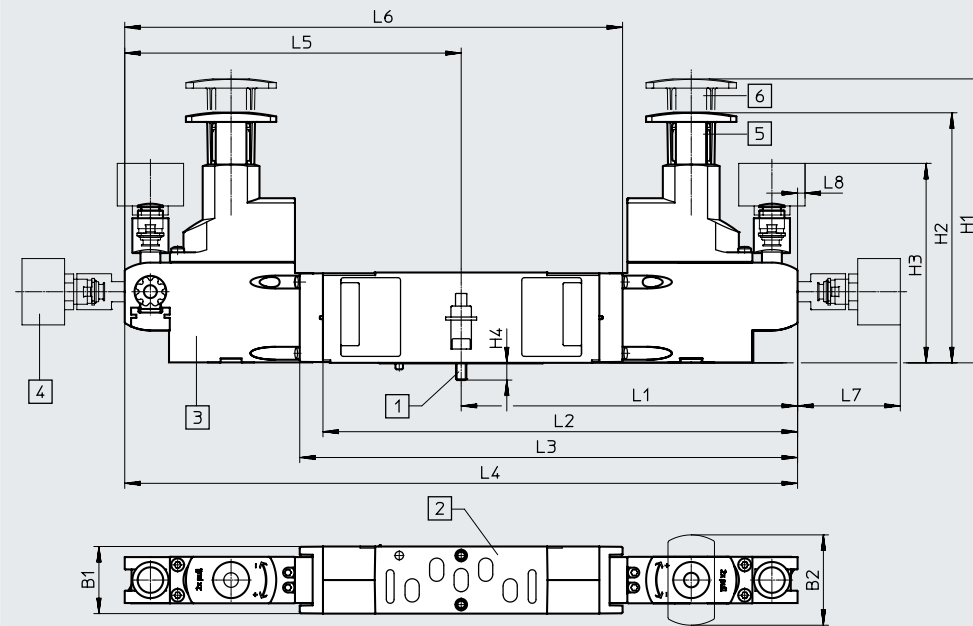

- [1] Captive screws
- [2] Port pattern to ISO 15407-1
- [3] Regulator
- [4] Pressure gauge
- [5] Regulator head, locked
- [6] Regulator head for adjusting the pressure

Dimensions when mounted → 77

Type	B1	B2	H1	H2	H3	H4	L1	L2	L3	L4	L5	L6	L7	L8
VABF-S3-2-R1	18	35	110	97	77.3	5.6	126.7	180.6	–	–	–	–	39.8	2.9
VABF-S3-2-R2							126.7	–	187.7	–	–	–		
VABF-S3-2-R3							–	–	–	–	126.7	187.7		
VABF-S3-2-R4							126.7	–	–	253.4	–	–		
VABF-S3-2-R5							126.7	–	–	253.4	–	–		
VABF-S3-2-R6							126.7	–	187.7	–	–	–		
VABF-S3-2-R7							–	–	–	–	126.7	187.7		
VABF-S3-1-R1	26	35	110	97	77.3	5.6	130.4	183.9	183.9	–	–	–	39.8	2.9
VABF-S3-1-R2							130.4	–	192.9	–	–	–		
VABF-S3-1-R3							–	–	–	–	130.4	192.9		
VABF-S3-1-R4							130.4	–	–	260.7	–	–		
VABF-S3-1-R5							130.4	–	–	260.7	–	–		
VABF-S3-1-R6							130.4	195	195	–	–	–		
VABF-S3-1-R7							–	–	–	–	130.4	192.9		

Vertical stacking

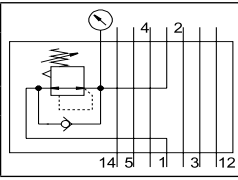
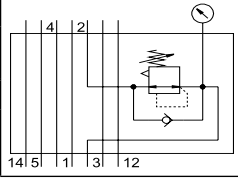
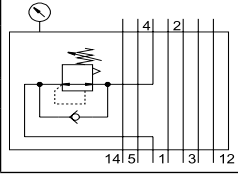
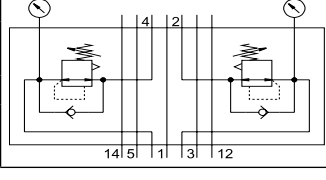
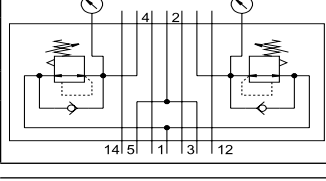
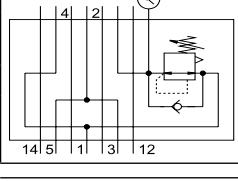
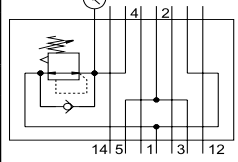
Ordering data						
Code	Circuit symbol	Control range	Valve size [mm]	Weight [g]	Part no.	Type
Pressure regulator for 1						
ZA		0.05 ... 0.85 MPa	18	370	543526	VABF-S3-2-R1C2-C-10
		0.5 ... 8.5 bar	26	305	543527	VABF-S3-1-R1C2-C-10
		7.25 ... 123.25 psi				
ZF		0.05 ... 0.6 MPa	18	370	543524	VABF-S3-2-R1C2-C-6
		0.5 ... 6 bar	26	305	543525	VABF-S3-1-R1C2-C-6
		7.25 ... 87 psi				
Pressure regulator for 2						
ZC		0.2 ... 0.85 MPa	18	245	543534	VABF-S3-2-R2C2-C-10
		2 ... 8.5 bar	26	305	543535	VABF-S3-1-R2C2-C-10
		29 ... 123.25 psi				
ZH		0.2 ... 0.6 MPa	18	245	543532	VABF-S3-2-R2C2-C-6
		2 ... 6 bar	26	305	543533	VABF-S3-1-R2C2-C-6
		29 ... 87 psi				
Pressure regulator for 4						
ZB		0.2 ... 0.85 MPa	18	245	543530	VABF-S3-2-R3C2-C-10
		2 ... 8.5 bar	26	305	543531	VABF-S3-1-R3C2-C-10
		29 ... 123.25 psi				
ZG		0.2 ... 0.6 MPa	18	245	543528	VABF-S3-2-R3C2-C-6
		2 ... 6 bar	26	305	543529	VABF-S3-1-R3C2-C-6
		29 ... 87 psi				
Pressure regulator for 2 and 4						
ZD		0.2 ... 0.85 MPa	18	370	543538	VABF-S3-2-R4C2-C-10
		2 ... 8.5 bar	26	430	543539	VABF-S3-1-R4C2-C-10
		29 ... 123.25 psi				
ZI		0.2 ... 0.6 MPa	18	370	543536	VABF-S3-2-R4C2-C-6
		2 ... 6 bar	26	430	543537	VABF-S3-1-R4C2-C-6
		29 ... 87 psi				
Pressure regulator for 2 and 4 reversible						
ZE		0.05 ... 0.85 MPa	18	245	543542	VABF-S3-2-R5C2-C-10
		0.5 ... 8.5 bar	26	430	543543	VABF-S3-1-R5C2-C-10
		7.25 ... 123.25 psi				
ZJ		0.05 ... 0.6 MPa	18	245	543540	VABF-S3-2-R5C2-C-6
		0.5 ... 6 bar	26	430	543541	VABF-S3-1-R5C2-C-6
		7.25 ... 87 psi				
Pressure regulator for 2 reversible						
ZL		0.05 ... 0.85 MPa	18	245	546788	VABF-S3-2-R6C2-C-10
		0.5 ... 8.5 bar	26	305	546789	VABF-S3-1-R6C2-C-10
		7.25 ... 123.25 psi				
ZN		0.05 ... 0.6 MPa	18	245	546786	VABF-S3-2-R6C2-C-6
		0.5 ... 6 bar	26	305	546787	VABF-S3-1-R6C2-C-6
		7.25 ... 87 psi				
Pressure regulator for 4 reversible						
ZK		0.05 ... 0.85 MPa	18	245	546792	VABF-S3-2-R7C2-C-10
		0.5 ... 8.5 bar	26	305	546793	VABF-S3-1-R7C2-C-10
		7.25 ... 123.25 psi				
ZM		0.05 ... 0.6 MPa	18	245	546790	VABF-S3-2-R7C2-C-6
		0.5 ... 6 bar	26	305	546791	VABF-S3-1-R7C2-C-6
		7.25 ... 87 psi				

Vertical stacking

Throttle plate

VABF-S3-2-F

VABF-S3-1-F

Material:

Housing: Die-cast aluminium



Note on materials:

RoHS-compliant

LABS (PWIS) conformity:

VDMA24364-B1/B2-L



-  Temperature range
-5 ... +50 °C
-  Operating pressure
-0.9 ... 10 bar

General technical data	
Based on norm	ISO 15407-1
Mounting position	Any
Pneumatic vertical stacking	Throttle plate, exhaust air flow control
Type of mounting for vertical stacking	On manifold sub-base On individual sub-base

Operating and environmental conditions	
Operating medium	Compressed air to ISO 8573-1:2010 [7:4:4]
Note on the operating/pilot medium	Lubricated operation possible (in which case lubricated operation will always be required)
Operating pressure [bar]	-0.9 ... 10
Ambient temperature [°C]	-5 ... +50
Corrosion resistance class CRC ¹⁾	0 - no corrosion stress
Degree of protection	IP65 NEMA 4

1) More information www.festo.com/x/topic/crc

Dimensions

Download CAD data → www.festo.com

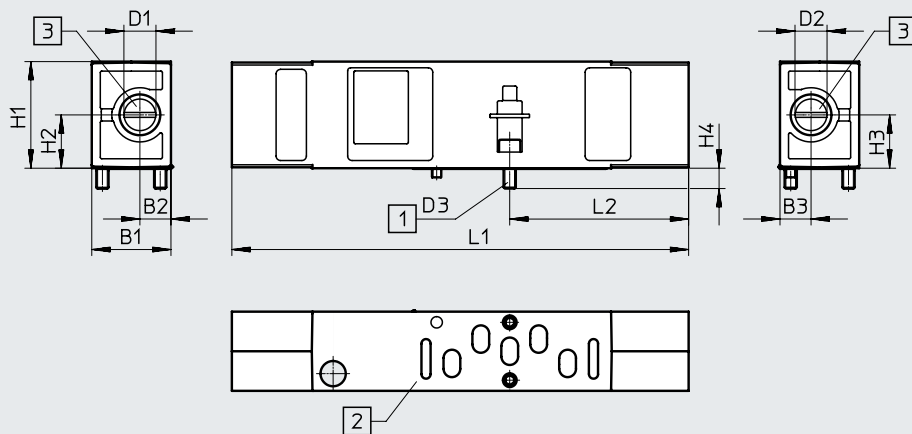

- [1] Captive screws
- [2] Port pattern to ISO 15407-1
- [3] Adjusting screws

Dimensions when mounted → 78

Type	B1	B2	B3	D1	D2	D3	H1	H2	H3	H4	L1	L2
VABF-S3-2-F1B1-C	18	6.5	6.5	9.3	9.3	M3x 12	35	12	12	5.6	130	43.3
VABF-S3-1-F1B1-C	26	10.2	10.2	11.2	11.2	M4x 12	35	17.5	17.5	6.7	150	58.8

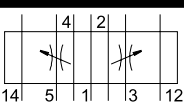
Ordering data		Description	Valve size [mm]	Weight [g]	Part no.	Type
Code	Circuit symbol					
X		For exhaust air flow control in ducts 3 and 5 on the valve	18	228	543603	VABF-S3-2-F1B1-C
			26	320	543604	VABF-S3-1-F1B1-C



Vertical stacking

Vertical supply plate
VABF-S3-2-P
VABF-S3-1-P

Material:
 Housing: Die-cast aluminium

Note on materials:
 RoHS-compliant

LABS (PWIS) conformity:
 VDMA24364-B1/B2-L

-  Temperature range
 -5 ... +50 °C
-  Operating pressure
 -0.9 ... +10 bar



General technical data

Based on norm	ISO 15407-1
Mounting position	Any
Pneumatic vertical stacking	Alternative compressed air supply for 1
Type of mounting for vertical stacking	On manifold sub-base On individual sub-base

Operating and environmental conditions

Operating medium	Compressed air to ISO 8573-1:2010 [7:4:4]
Note on the operating/pilot medium	Lubricated operation possible (in which case lubricated operation will always be required)
Operating pressure [bar]	-0.9 ... 10
Ambient temperature [°C]	-5 ... +50
Corrosion resistance class CRC ¹⁾	0 - no corrosion stress
Degree of protection	IP65 NEMA 4

1) More information www.festo.com/x/topic/crc

Dimensions

Download CAD data → www.festo.com

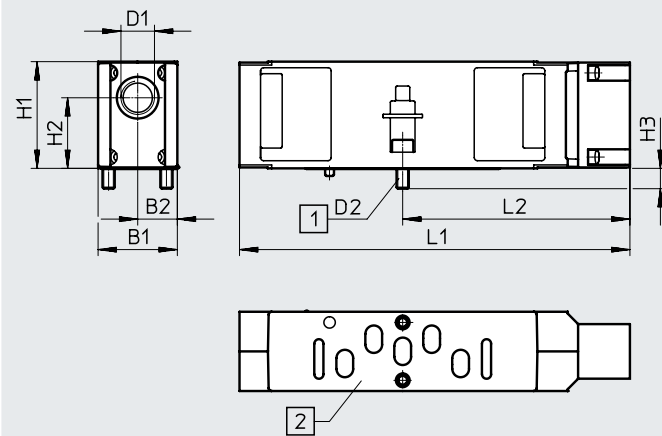

- [1] Captive screws
- [2] Port pattern to ISO 15407-1

Dimensions when mounted → 79

Type	B1	B2	D1	D2	H1	H2	H3	L1	L2
VABF-S3-2-P1A3-G18	18	9	G1/8	M3x 12	35	23.4	5.6	121.6	67.7
VABF-S3-1-P1A3-G14	26	13	G1/4	M4x 12	35	23.2	6.7	128.1	74.6

Ordering data

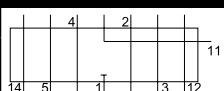
Code	Circuit symbol	Description	Valve size [mm]	Flow rate [l/min]	Weight [g]	Part no.	Type
ZU		For the independent supply of a valve	18	500	146	544435	VABF-S3-2-P1A3-G18
			26	1000	201	544434	VABF-S3-1-P1A3-G14

Vertical stacking

Vertical pressure shut-off plate

VABF-S3-2-L

VABF-S3-1-L

Material:

Housing: Die-cast aluminium



Note on materials:

RoHS-compliant

LABS (PWIS) conformity:

VDMA24364-B1/B2-L



-  Temperature range
-5 ... +50 °C
-  Input pressure
-0.9 ... +10 bar

General technical data	
Based on norm	ISO 15407-1
Mounting position	Any
Pneumatic vertical stacking	Shut-off for 1
Type of mounting for vertical stacking	On manifold sub-base On individual sub-base

Operating and environmental conditions	
Operating medium	Compressed air to ISO 8573-1:2010 [7:4:4]
Note on the operating/pilot medium	Lubricated operation possible (in which case lubricated operation will always be required)
Operating pressure [bar]	-0.9 ... 10
Ambient temperature [°C]	-5 ... +50
Corrosion resistance class CRC ¹⁾	0 - no corrosion stress
Degree of protection	IP65 NEMA 4

1) More information www.festo.com/x/topic/crc

Dimensions

Download CAD data → www.festo.com

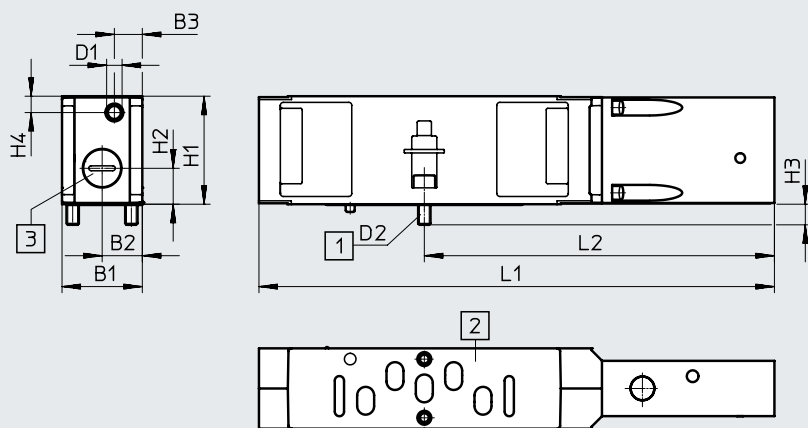

- [1] Captive screws
- [2] Port pattern to ISO 15407-1
- [3] Plug screw

Dimensions when mounted → 80

Type	B1	B2	B3	D1	D2	H1	H2	H3	H4	L1	L2
VABFS3-2-L1D1-C	18	9	5.1	M5	M3x 12	35	11.7	5.6	5.3	163.7	109.8
VABFS3-1-L1D1-C	26	13	9.1	M5	M4x 12	35	11.6	6.7	5.3	167	113.4

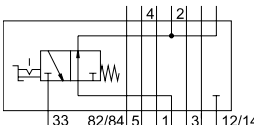
Ordering data								
Code	Circuit symbol	Description	Valve size [mm]	Flow rate [l/min]	Weight [g]	Part no.	Type	
ZT		For shutting off a valve from the supply pressure	18 26	400 800	212 286	543601 543602	VABF-S3-2-L1D1-C VABF-S3-1-L1D1-C	

Individual linking

Individual sub-base NAS

Materials:
Die-cast aluminium

LABS (PWIS) conformity:
VDMA24364-B1/B2-L



Operating and environmental conditions

Operating medium	Compressed air to ISO 8573-1:2010 [7:4:4]
Note on the operating/pilot medium	Lubricated operation possible (in which case lubricated operation will always be required)

Dimensions

Download CAD data → www.festo.com

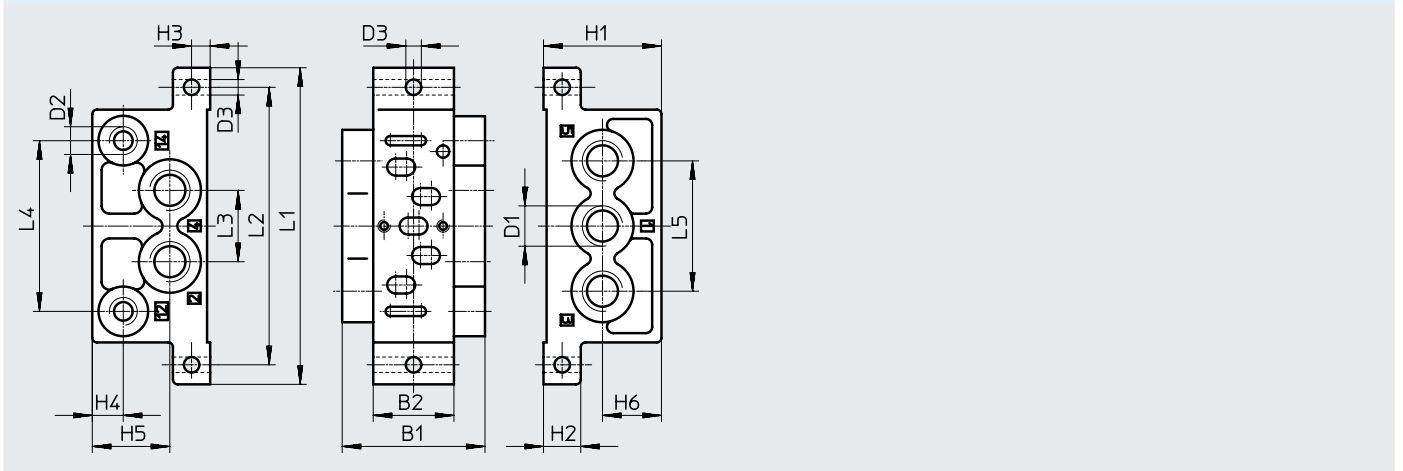

Type	B1	B2	D1	D2	D3	H1	H2	H3	H4	H5	H6	L1	L2	L3	L4	L5
NAS-1/8-02-VDMA	28.5	18	G1/8	M5	5.5	31	10	5	7	20	14.5	79	66.5	17	40	32
NAS-1/4-01-VDMA	46	26	G1/4	G1/8	5	38	12	6	10	25	19	102	89.4	23	55	42

Ordering data

Type of mounting	Valve size [mm]	Pneumatic connection		Weight [g]	Part no.	Type
		1, 2, 3, 4, 5	12, 14			
Two through-holes in the housing	18	G1/8	M5	67	161115	NAS-1/8-02-VDMA
	26	G1/4	G1/8	160	161109	NAS-1/4-01-VDMA

Horizontal stacking

Manifold sub-base NAW

Materials:
Die-cast aluminium

LABS (PWIS) conformity:
VDMA24364-B1/B2-L



General technical data						
Based on norm				ISO 15407-1		
Operating and environmental conditions						
Operating medium				Compressed air to ISO 8573-1:2010 [7:4:4]		
Note on the operating/pilot medium				Lubricated operation possible (in which case lubricated operation will always be required)		
Ordering data						
Manifold sub-base	Valve size [mm]	Pneumatic connection		Weight [g]	Part no.	Type
		2, 4	12, 14			
For solenoid valves	18	G1/8	–	130	161110	NAW-1/8-02-VDMA
	26	G1/4	–	225	161102	NAW-1/4-01-VDMA
For pneumatic valves	18	G1/8	M5	130	161111	NAW-1/8-02-VDMA-VL
	26	G1/4	M5	225	161103	NAW-1/4-01-VDMA-VL

Dimensions → 74

End plate kit NEV

Materials:
Die-cast aluminium

LABS (PWIS) conformity:
VDMA24364-B1/B2-L



Operating and environmental conditions						
Operating medium				Compressed air to ISO 8573-1:2010 [7:4:4]		
Note on the operating/pilot medium				Lubricated operation possible (in which case lubricated operation will always be required)		
Ordering data						
Scope of delivery	Valve size [mm]	Pneumatic connection		Weight [g]	Part no.	Type
		1, 3, 5	12, 14			
End plate left and right, screws, H-rail mounting, one isolating disc each for ports 1, 3, 5, 12 and 14	18	G3/8	G1/8	280	161112	NEV-02-VDMA
	26	G1/2	G1/8	445	161104	NEV-01-VDMA
End plate left 18 mm and right 26 mm, screws, H-rail mounting	18, 26	G3/8, G1/2	G1/8	372	191405	NEV-02-01-VDMA

Dimensions → 74

Horizontal stacking

Intermediate plate NZV

For combining manifold with valve sizes 18 mm and 26 mm

Materials:
Die-cast aluminium

LABS (PWIS) conformity:
VDMA24364-B1/B2-L

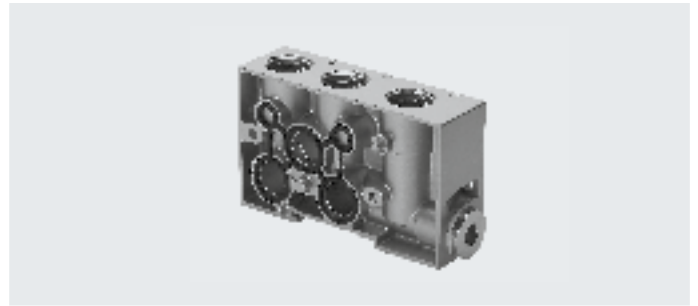

Operating and environmental conditions

Operating medium	Compressed air to ISO 8573-1:2010 [7:4:4]
Note on the operating/pilot medium	Lubricated operation possible (in which case lubricated operation will always be required)

Dimensions

Download CAD data → www.festo.com

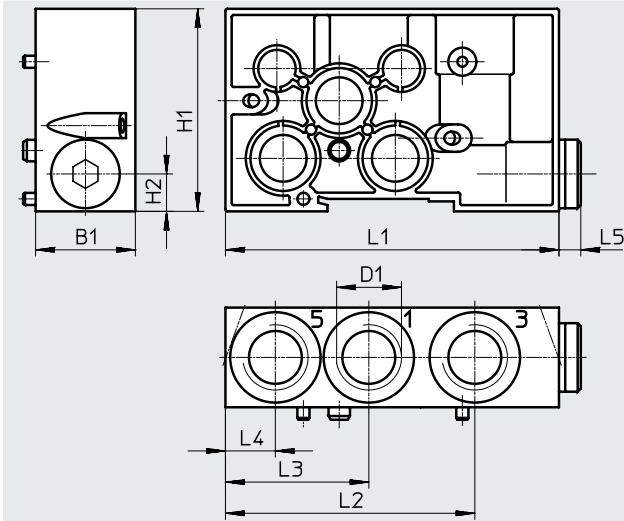

Type	B1	D1	H1	H2	L1	L2	L3	L4	L5
NZV-0 1/02-VDMA	32	G1/2	65	12	107	80	46	16	7

Ordering data

Description	Valve size [mm]	Pneumatic connection		Weight [g]	Part no.	Type
		1, 3, 5	12, 14			
Intermediate plate to combine manifold sub-bases of valve size 18 mm and 26 mm	18 and 26	G1/2	–	270	161108	NZV-01/02-VDMA

Datasheet

Dimensions – Manifold sub-bases without valves

Download CAD data → www.festo.com

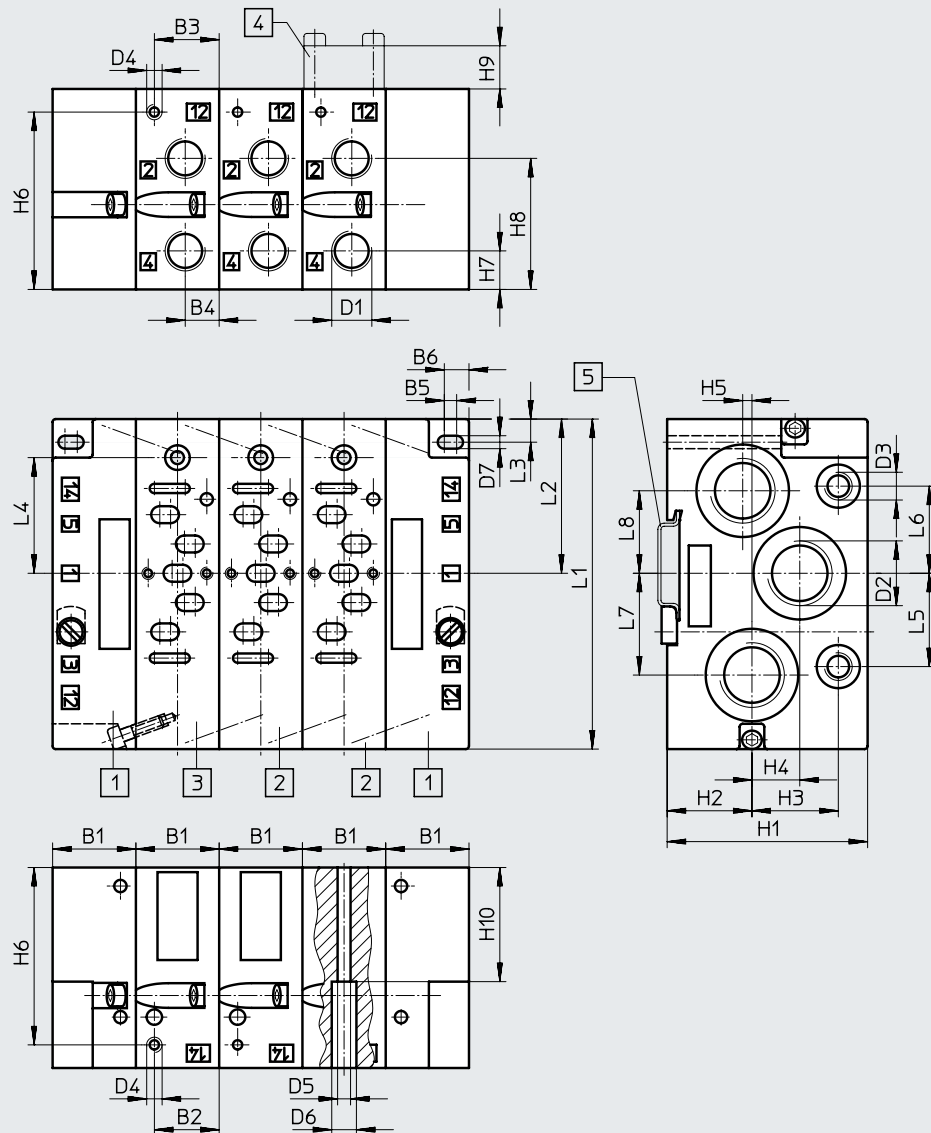

- [1] End plate kit
NEV...VDMA
→ 72
- [2] Manifold sub-base
NAW...-VDMA
→ 72
- [3] Manifold sub-base
NAW...-VDMA-VL
→ 72
- [4] Cover plate
NDV...-VDMA
→ 81
- [5] DIN mounting rail
NRH-35-2000
→ www.festo.com

Valve size [mm]	B1	B2	B3	B4	B5	B6	D1	D2	D3	D4	D5	D6	D7
18	19	6	13	7.5	1	4.5	G1/8	G3/8	G1/8	M5	3.3	6.3	4.3
26	27	21	21	11	4	8	G1/4	G1/2	G1/8	M5	4.2	8	4.2

Valve size [mm]	H1	H2	H3	H4	H5	H6	H7	H8	H9	H10	L1	L2	L3	L4	L5	L6	L7	L8
18	55	17	28.8	18.5	–	48	10.5	35.5	12	40	81	36.5	5.6	30.9	20	20	18	18
26	65	27.5	28	15.5	3	57.5	12.5	42.5	14	37	107	50	7.5	37.5	30.3	28.3	33	26.8

Datasheet

Dimensions – Manifold assembly, valve size 18 mm

Download CAD data → www.festo.com

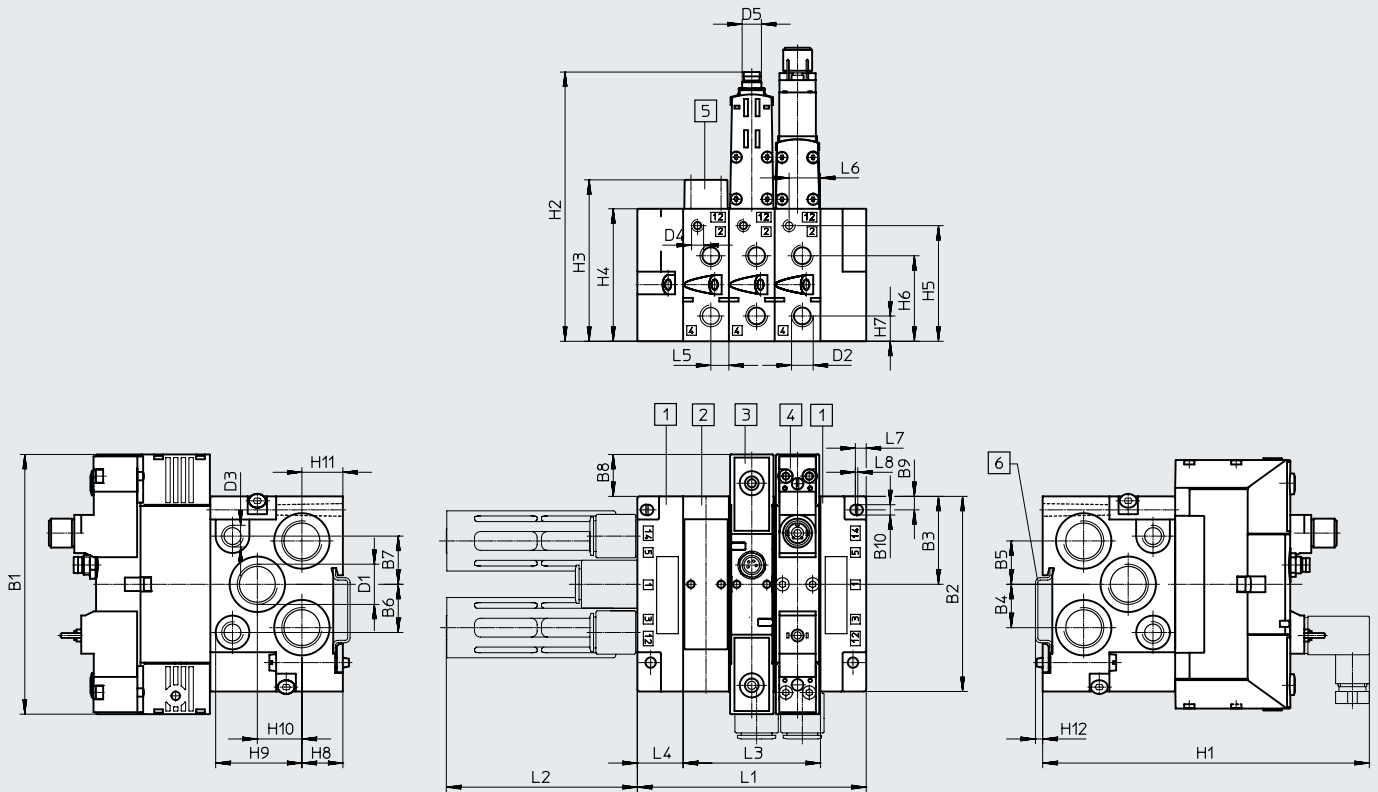

- [1] End plate kit type NEV-02-VDMA
- [2] Manifold sub-bases type NAW-1/8-02-VDMA
- [3] Solenoid valve with central plug
- [4] Solenoid valve with pilot interface to ISO 15218
- [5] Cover plate NDV-02-VDMA
- [6] DIN mounting rail NRH-35-2000

Type	B1	B2	B3	B4	B5	B6	B7	B8	B9	B10	D1	D2	D3	D4	D5	H1	H2	H3
VSVA-B-...A2	107.8	81	36.5	18	18	20	20	17.4	5.6	4.3	G3/8	G1/8	G1/8	M5	–	135.6	55	67
VSVA-B-M52-...A2	95.4	81	36.5	18	18	20	20	5	5.6	4.3	G3/8	G1/8	G1/8	M5	–	135.6	55	67
VSVA-B-...A2-R2L	107.8	81	36.5	18	18	20	20	17.4	5.6	4.3	G3/8	G1/8	G1/8	M5	M8	121.8	111.8	67
VSVA-B-...A2-R5L	107.8	81	36.5	18	18	20	20	17.4	5.6	4.3	G3/8	G1/8	G1/8	M5	M12	121.8	111.8	67

Type	H4	H5	H6	H7	H8	H9	H10	H11	H12	L1	L2	L3	L4	L5	L6	L7	L8
VSVA-B-...A2	55	48	35.5	10.5	17	35.9	18.5	17	3.5	38 + nx 19	79.1	nx 19	19	7.5	13	4.5	1
VSVA-B-M52-...A2	55	48	35.5	10.5	17	35.9	18.5	17	3.5	38 + nx 19	79.1	nx 19	19	7.5	13	4.5	1
VSVA-B-...A2-R2L	55	48	35.5	10.5	17	35.8	18.5	17	3.5	38 + nx 19	79.1	nx 19	19	7.5	13	4.5	1
VSVA-B-...A2-R5L	55	48	35.5	10.5	17	35.8	18.5	17	3.5	38 + nx 19	79.1	nx 19	19	7.5	13	4.5	1

Datasheet

Dimensions – Manifold assembly, valve size 26 mm

Download CAD data → www.festo.com

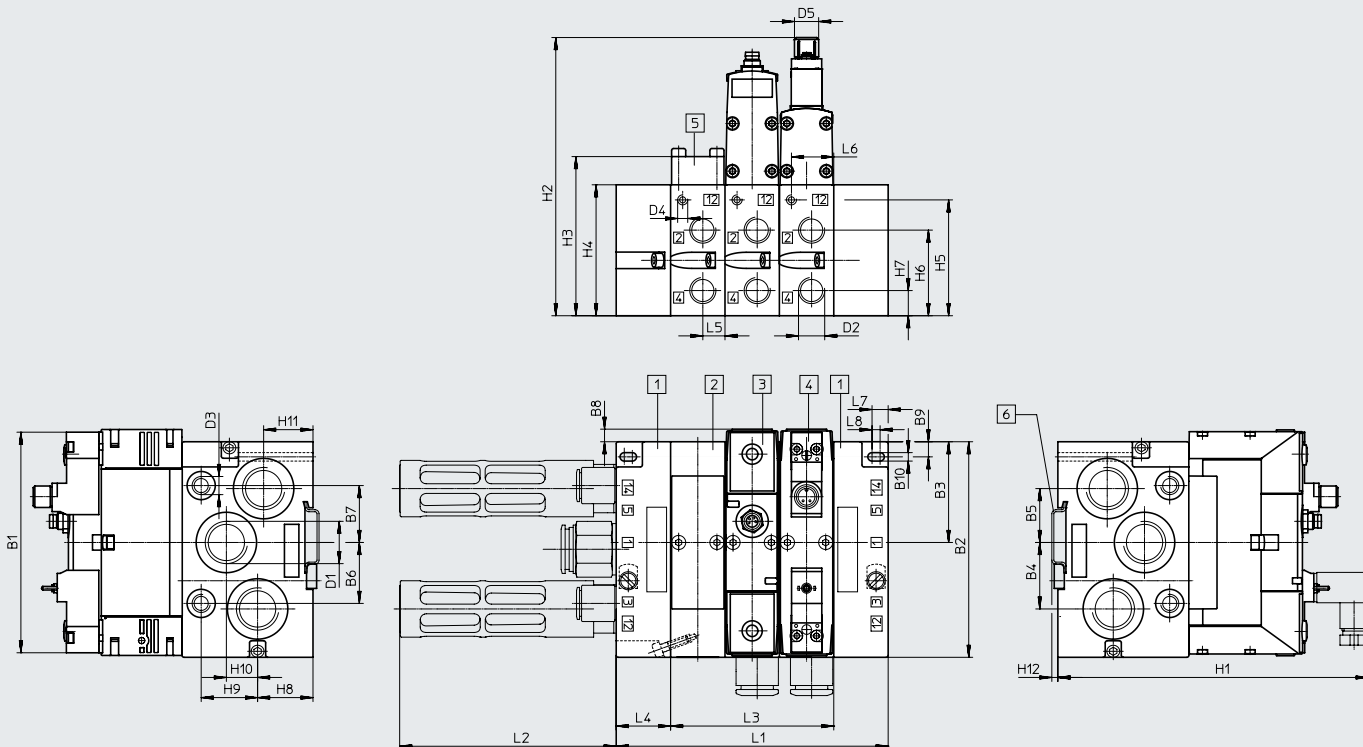

- [1] End plate kit type NEV-01-VDMA
- [2] Manifold sub-bases type NAW-1/4-01-VDMA
- [3] Solenoid valve with central plug
- [4] Solenoid valve with pilot interface to ISO 15218
- [5] Cover plate NDV-01-VDMA
- [6] DIN mounting rail NRH-35-2000

Type	B1	B2	B3	B4	B5	B6	B7	B8	B9	B10	D1	D2	D3	D4	D5	H1	H2
VSVA-B-...A1	113.1	107	50	33	26.8	30.3	28.3	13.1	7.5	4.2	G1/2	G1/4	G1/8	M5	–	154.2	65
VSVA-B-M52-...A1	126.2	107	50	33	26.8	30.3	28.3	13.1	7.5	4.2	G1/2	G1/4	G1/8	M5	–	154.2	65
VSVA-B-...A1-R2L	112.5	107	50	33	26.8	30.3	28.3	6.3	7.5	4.2	G1/2	G1/4	G1/8	M5	M8x 1	157	128.3
VSVA-B-...A1-R5L	112.5	107	50	33	26.8	30.3	28.3	6.3	7.5	4.2	G1/2	G1/4	G1/8	M5	M12x 1	157	131.6

Type	H3	H4	H5	H6	H7	H8	H9	H10	H11	H12	L1	L2	L3	L4	L5	L6	L7	L8
VSVA-B-...A1	79	65	57.5	42.5	12.5	27.5	28	15.5	24.5	3.5	54 + nx 27	107.5	nx 27	27	11	21	8	4
VSVA-B-M52-...A1	79	65	57.5	42.5	12.5	27.5	28	15.5	24.5	3.5	54 + nx 27	107.5	nx 27	27	11	21	8	4
VSVA-B-...A1-R2L	79	65	57.5	42.5	12.5	27.5	28	15.5	24.5	3.5	54 + nx 27	107.5	nx 27	27	11	21	8	4
VSVA-B-...A1-R5L	79	65	57.5	42.5	12.5	27.5	28	15.5	24.5	3.5	54 + nx 27	107.5	nx 27	27	11	21	8	4

Datasheet

Dimensions - Pressure regulator

Download CAD data → www.festo.com

Valve size 18 mm with manifold sub-base and solenoid valve with central plug

Valve size 18 mm with manifold sub-base and solenoid valve with central plug to ISO 15218

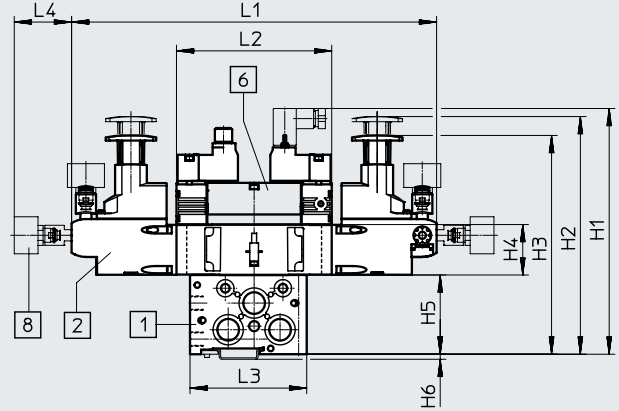
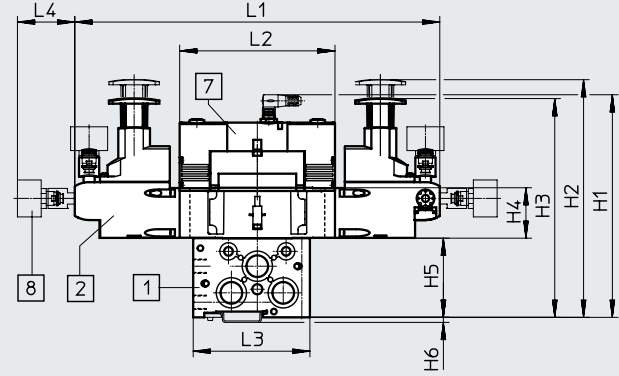

- [1] Manifold sub-base NAW
- [2] Regulator plate
- [7] Solenoid valve VSVA
- [8] Pressure gauge, freely position-able

- [1] Manifold sub-base NAW
- [2] Regulator plate
- [6] Solenoid valve VSVA
- [8] Pressure gauge, freely position-able

Valve size 26 mm with manifold sub-base and solenoid valve with central plug

Valve size 26 mm with manifold sub-base and solenoid valve with central plug to ISO 15218

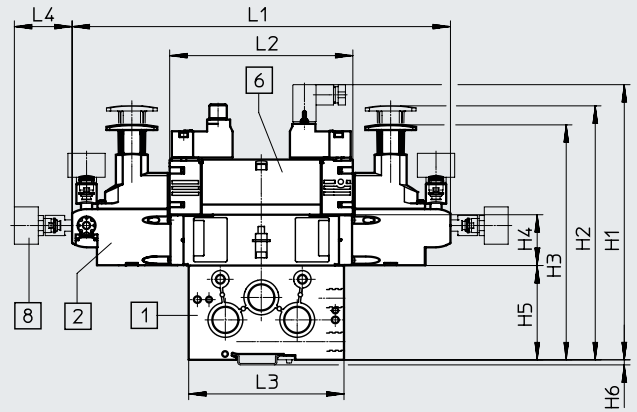
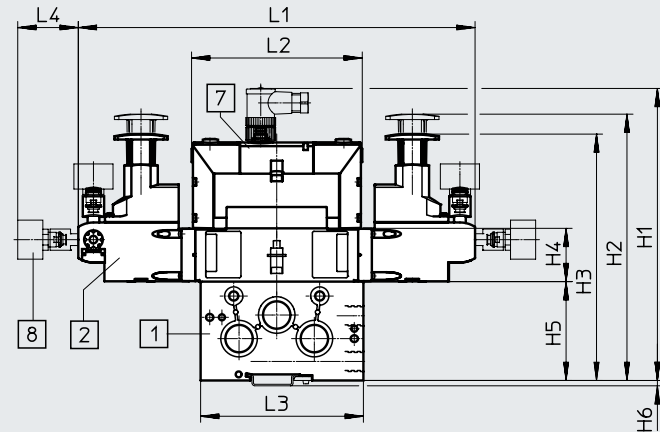

- [1] Manifold sub-base NAW
- [2] Regulator plate
- [7] Solenoid valve VSVA
- [8] Pressure gauge, freely position-able

- [1] Manifold sub-base NAW
- [2] Regulator plate
- [6] Solenoid valve VSVA
- [8] Pressure gauge, freely position-able

Valve size [mm]	Solenoid valve	H1	H2	H3	H4	H5	H6	L1	L2	L3	L4
18	With central plug	156.8	165	152	35	55	3.5	253.4	107.8	81	39.8
	With pilot interface to ISO 15218	170.6									
26	With central plug	192	175	162	35	65	3.5	260.7	112.5	107	39.8
	With pilot interface to ISO 15218	189.6							126.2		

Datasheet

Dimensions – Throttle plate

Download CAD data → www.festo.com

Valve size 18 mm with manifold sub-base and solenoid valve with central plug

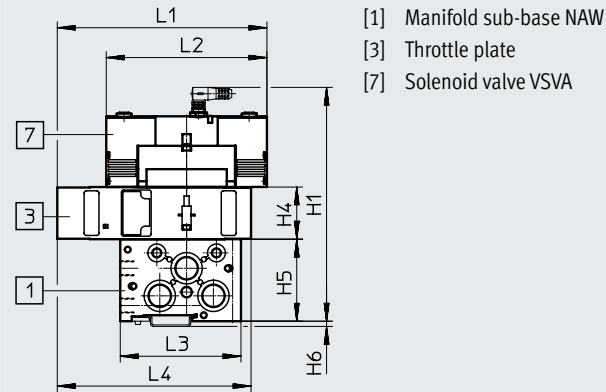

Valve size 18 mm with manifold sub-base and solenoid valve with central plug to ISO 15218

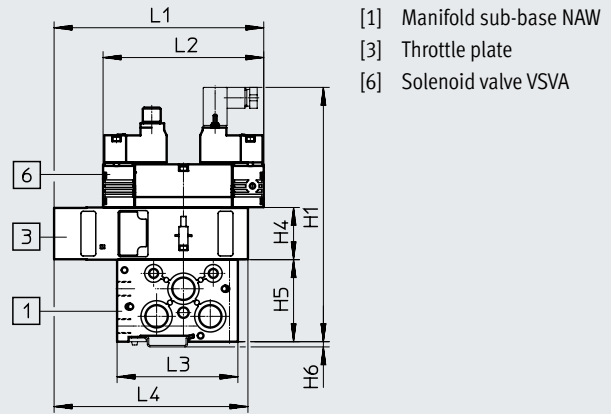

Valve size 26 mm with manifold sub-base and solenoid valve with central plug

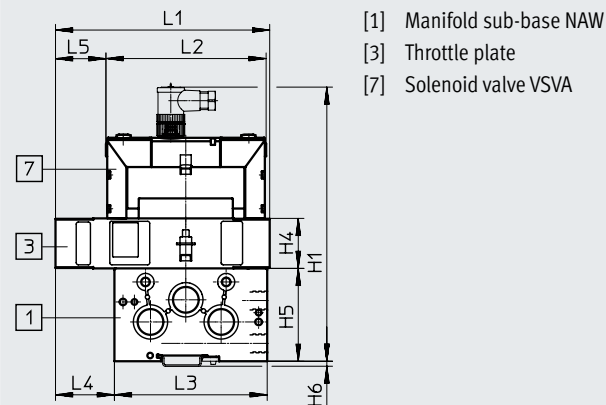

Valve size 26 mm with manifold sub-base and solenoid valve with central plug to ISO 15218

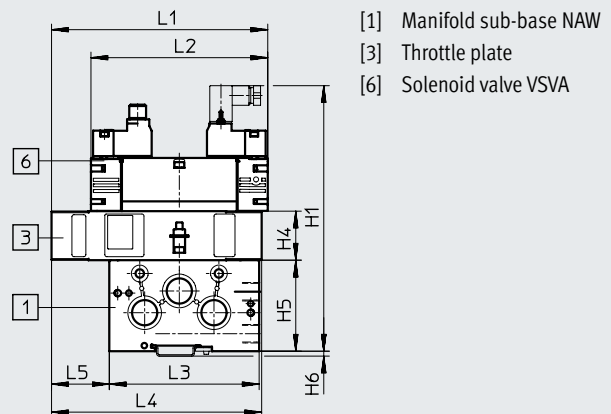

Valve size [mm]	Solenoid valve	H1	H4	H5	H6	L1	L2	L3	L4	L5
18	With central plug	156.8	35	55	3.5	140.8	107.8	81	130	-
	With pilot interface to ISO 15218	170.6								
26	With central plug	192	35	65	3.5	150	112.5	107	41.3	35
	With pilot interface to ISO 15218	189.6				154.4	126.2		150	41.3

Datasheet

Dimensions – Vertical supply plate

Download CAD data → www.festo.com

Valve size 18 mm with manifold sub-base and solenoid valve with central plug

Valve size 18 mm with manifold sub-base and solenoid valve with central plug to ISO 15218

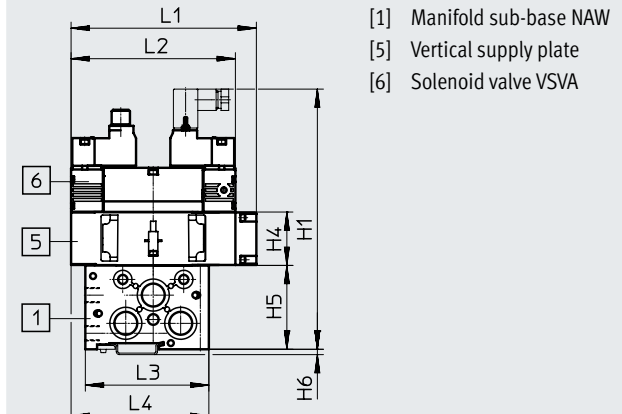
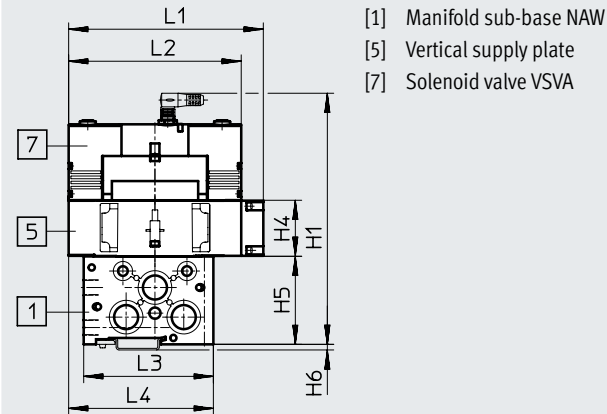

Valve size 26 mm with manifold sub-base and solenoid valve with central plug

Valve size 26 mm with manifold sub-base and solenoid valve with central plug to ISO 15218

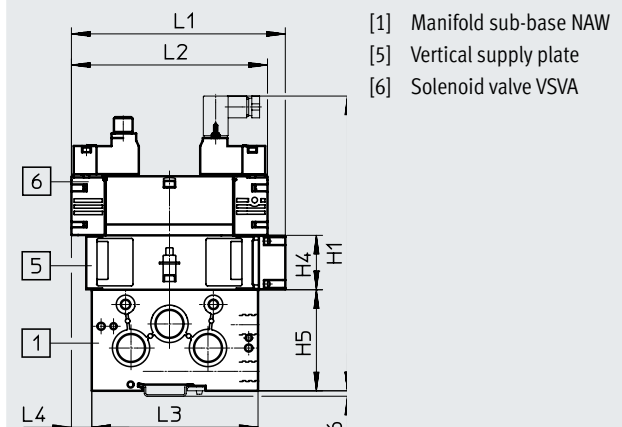
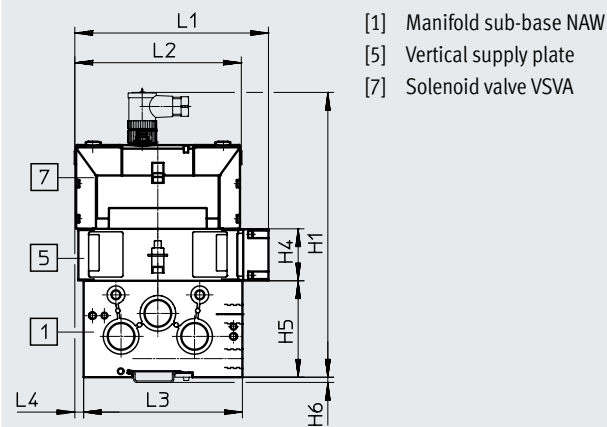

Valve size [mm]	Solenoid valve	H1	H4	H5	H6	L1	L2	L3	L4
18	With central plug	156.8	35	55	3.5	121.55	107.8	81	90.4
	With pilot interface to ISO 15218	170.6							
26	With central plug	192	35	65	3.5	130.8	112.5	107	6.3
	With pilot interface to ISO 15218	189.6				137.7			126.2

Datasheet

Dimensions – Vertical pressure shut-off plate

Download CAD data → www.festo.com

Valve size 18 mm with manifold sub-base and solenoid valve with central plug

Valve size 18 mm with manifold sub-base and solenoid valve with central plug to ISO 15218

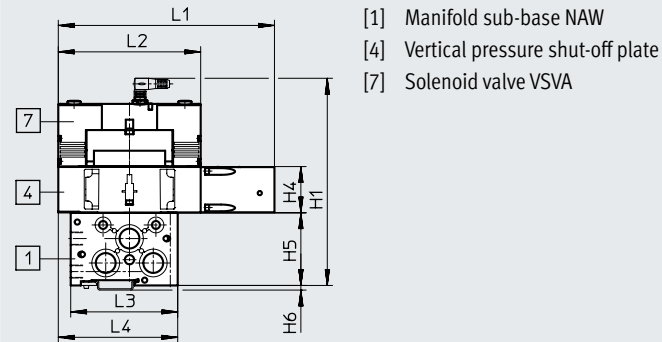

- [1] Manifold sub-base NAW
- [4] Vertical pressure shut-off plate
- [7] Solenoid valve VSVA

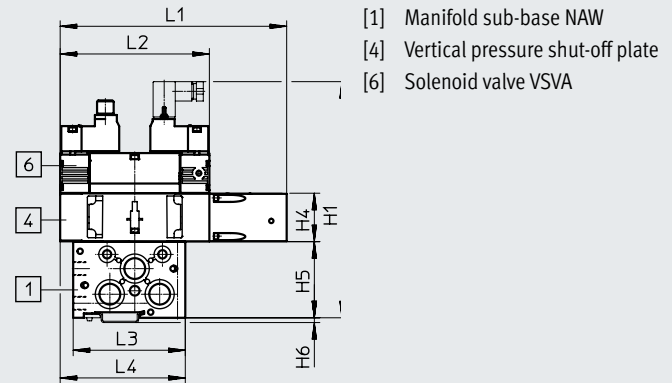

- [1] Manifold sub-base NAW
- [4] Vertical pressure shut-off plate
- [6] Solenoid valve VSVA

Valve size 26 mm with manifold sub-base and solenoid valve with central plug

Valve size 26 mm with manifold sub-base and solenoid valve with central plug to ISO 15218

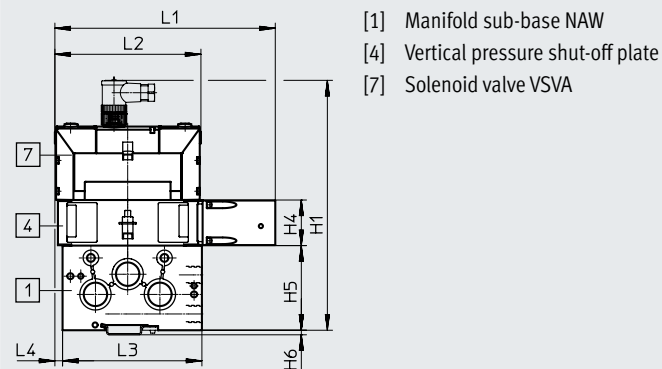

- [1] Manifold sub-base NAW
- [4] Vertical pressure shut-off plate
- [7] Solenoid valve VSVA

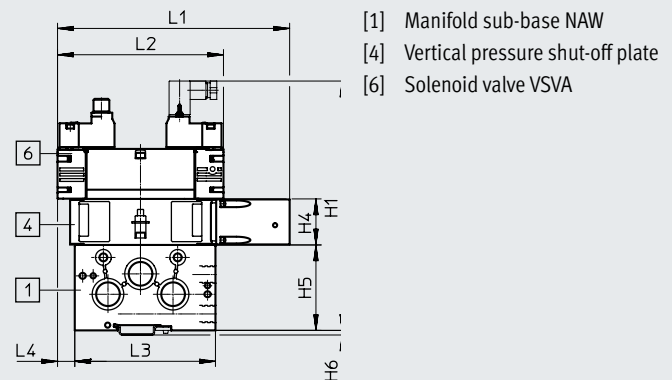

- [1] Manifold sub-base NAW
- [4] Vertical pressure shut-off plate
- [6] Solenoid valve VSVA

Valve size [mm]	Solenoid valve	H1	H4	H5	H6	L1	L2	L3	L4
18	With central plug	156.8	35	55	3.5	163.8	107.8	81	90.4
	With pilot interface to ISO 15218	170.6							
26	With central plug	192	35	65	3.5	169.7	112.5	107	6.3
	With pilot interface to ISO 15218	189.6				176.5	126.2		13.1

Accessories

Isolating disc NSC

Materials:
Aluminium

LABS (PWIS) conformity:
VDMA24364-B1/B2-L

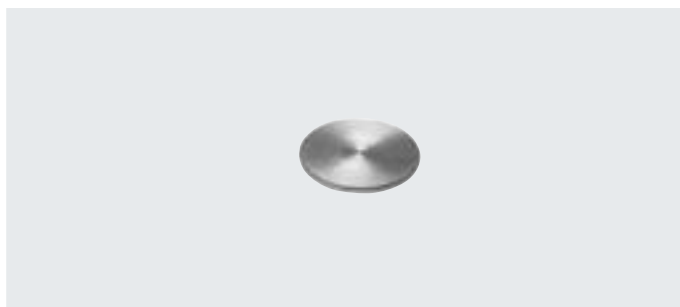

Operating and environmental conditions	
Operating medium	Compressed air to ISO 8573-1:2010 [7:4:4]
Note on the operating/pilot medium	Lubricated operation possible (in which case lubricated operation will always be required)

Ordering data				
Description	Valve size	Weight	Part no.	Type
	[mm]	[g]		
Isolating disc for ports 1, 3, 5 (solenoid/pneumatic valves)	18	2	161113	NSC-3/8-02-VDMA
	26	2	161105	NSC-1/2-01-VDMA
Isolating disc for ports 12, 14 (pneumatic valves)	18	2	161106	NSC-1/8-01-VDMA
	26	2	161106	NSC-1/8-01-VDMA

Cover plate NDV

Materials:
POM

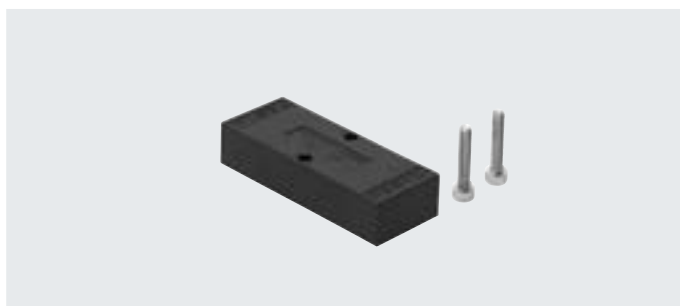

LABS (PWIS) conformity:
VDMA24364-B1/B2-L







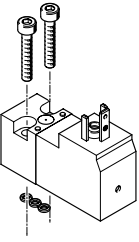
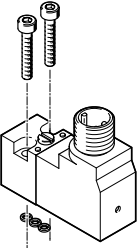

Operating and environmental conditions	
Operating medium	Compressed air to ISO 8573-1:2010 [7:4:4]
Note on the operating/pilot medium	Lubricated operation possible (in which case lubricated operation will always be required)

Ordering data				
Description	Valve size	Weight	Part no.	Type
	[mm]	[g]		
Cover plate to seal spare or vacant valve positions	18	22	161114	NDV-02-VDMA
	26	36	161107	NDV-01-VDMA



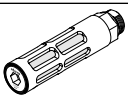
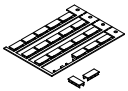

Accessories

Ordering data – Pilot valve to ISO 15218		Power		Voltage		Part no.	Type
		[W]	[VA]	[V DC]	[V AC]		
Square plug, type C EN 175301-803							
	Non-detenting manual override	1.8	–	12	–	546257	VSCS-B-M32-MH-WA-5C1
				24		546256	VSCS-B-M32-MH-WA-1C1
		–	3.1/2.3	–	24	546258	VSCS-B-M32-MH-WA-1AC1
					110	546259	VSCS-B-M32-MH-WA-2AC1
					230	546260	VSCS-B-M32-MH-WA-3AC1
	Non-detenting/detenting manual override	1.8	–	12	–	571062	VSCS-B-M32-MD-WA-5C1
				24		571061	VSCS-B-M32-MD-WA-1C1
		–	3.1/2.3	–	24	571063	VSCS-B-M32-MD-WA-1AC1
					230	571065	VSCS-B-M32-MD-WA-3AC1
					110	571064	VSCS-B-M32-MD-WA-2AC1
M12 plug IEC 61076-2-101							
	Non-detenting/detenting manual override	1.8	–	24	–	573215	VSCS-B-M32-MD-WA-1R3
	Detenting manual override	1.8	–	24	–	573214	VSCS-B-M32-MH-WA-1R3
Tool for manual override							
	For manual override, detenting, with pilot valve VSCS-B-M32-MT					157601	AHB-MEB

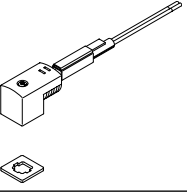
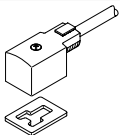

Accessories

Ordering data			Part no.	Type	
Pressure gauge Datasheets → Internet: pagn					
	With cartridge connection for regulator	0 ... 1 MPa		563736	PAGN-26-1M-P10
		0 ... 1.6 MPa		563735	PAGN-26-1.6M-P10
		0 ... 10 bar		543488	PAGN-26-10-P10
		0 ... 16 bar		543487	PAGN-26-16-P10
		0 ... 145 psi		563732	PAGN-26-145P-P10
		0 ... 232 psi		563731	PAGN-26-232P-P10
Cartridge for regulator plate					
	For tubing O.D.	4 mm	Pack of 10	172972	QSP10-4
Push-in fitting Datasheets → Internet: qs					
	Connecting thread M5 for tubing O.D.	4 mm	Pack of 10	★ 153315	QSM-M5-4-1
		6 mm	Pack of 10	★ 153317	QSM-M5-6-1
	Connecting thread G1/8 for tubing O.D.	6 mm	Pack of 10	★ 186096	QS-G1/8-6
		8 mm	Pack of 10	★ 186098	QS-G1/8-8
	Connecting thread G1/4 for tubing O.D.	8 mm	Pack of 10	★ 186099	QS-G1/4-8
		10 mm	Pack of 10	★ 186101	QS-G1/4-10
	Connecting thread G3/8 for tubing O.D.	12 mm	Pack of 10	★ 186103	QS-G3/8-12
		16 mm	Pack of 1	186347	QS-G3/8-16
	Connecting thread G1/2 for tubing O.D.	12 mm	Pack of 1	★ 186104	QS-G1/2-12
		16 mm	Pack of 1	186105	QS-G1/2-16
	Blanking plug Datasheets → Internet: b				
		For sealing ports that are not required	For M5 thread	Pack of 10	★ 3843
For G1/8 thread			Pack of 10	★ 3568	B-1/8
For G1/4 thread			Pack of 10	★ 3569	B-1/4
For G3/8 thread			Pack of 10	★ 3570	B-3/8
For G1/2 thread			Pack of 10	★ 3571	B-1/2
Silencer Datasheets → Internet: u					
	For reducing noise at exhaust ports	For G1/8 thread		6841	U-1/8-B
		For G1/4 thread		6842	U-1/4-B
		For G3/8 thread		6843	U-3/8-B
		For G1/2 thread		6844	U-1/2-B
Inscription label Datasheets → Internet: ibs					
	Inscription label, 9x20 mm, for valves	In frames	Pack of 24	18182	IBS-9x20
Inscription label holder Datasheets → Internet: ascf					
	Clip-on inscription label holder for valve cap, for pneumatic valves VSPA		Pack of 5	540888	ASCF-T-S6
Cover cap					
	For manual override, non-detenting or covered			8049538	VAMC-B10-20-CH2-S

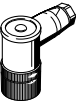
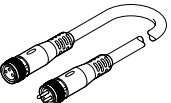
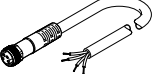
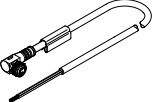
Accessories

Ordering data		Part no.	Type			
Plug socket for plug pattern to EN 175301-803, type C Datasheets → Internet: mssd						
	Via screw terminals	Cable fitting Pg7	★ 151687	MSSD-EB		
		Cable fitting M12	539712	MSSD-EB-M12		
	With insulation displacement connection	Cable fitting M14	192745	MSSD-EB-S-M14		
Plug socket for connection pattern type B, industry standard						
	Via screw terminals	Cable fitting M16	539710	MSSD-F-M16		
		Cable fitting Pg9	★ 34431	MSSD-F		
	With insulation displacement connection	Cable fitting M16	192746	MSSD-F-S-M16		
Connecting cable for plug pattern to EN 175301-803, type C Datasheets → Internet: kmeb						
	With LED signal status indication	24 V DC	2.5 m	★ 151688	KMEB-1-24-2.5-LED	
			24 V DC	5 m	151689	KMEB-1-24-5-LED
			24 V DC	10 m	193457	KMEB-1-24-10-LED
	Without signal status indication	Up to 240 V	2.5 m	151690	KMEB-1-230AC-2.5	
			Up to 240 V	5 m	151691	KMEB-1-230AC-5
Connecting cable for plug pattern type B, industry standard						
	With LED signal status indication	24 V DC	2.5 m	★ 30935	KMF-1-24DC-2.5-LED	
			5 m	30937	KMF-1-24DC-5-LED	
			10 m	193458	KMF-1-24-10-LED	
Illuminating seal Datasheets → Internet: meb-ld						
	Plug pattern to EN 175301-803, type C	12 ... 24 V DC	151717	MEB-LD-12-24DC		
		230 V AC	151718	MEB-LD-230AC		
	Plug pattern type B to industry standard	24 V DC	19143	MF-LD-12-24DC		
Plug sockets for valves, round plug M12x1 Datasheets → Internet: necu						
	Angled socket, 4-pin, type A, screw terminal	Cable fitting Pg7	12956	SIE-WD-TR		
Connecting cable for valves with round plug M8x1 Datasheets → Internet: nebu						
	Modular system for a choice of connecting cables → Internet: nebu	0.1 ... 30 m	–	NEBU-...		
	Straight socket, 4-pin Open cable end, 4-pin	2.5 m	541342	NEBU-M8G4-K-2.5-LE4		
		5 m	541343	NEBU-M8G4-K-5-LE4		
	Angled socket, 4-pin Open cable end, 4-pin	2.5 m	541344	NEBU-M8W4-K-2.5-LE4		
		5 m	541345	NEBU-M8W4-K-5-LE4		

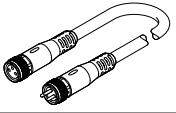
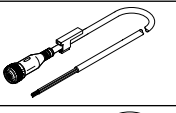
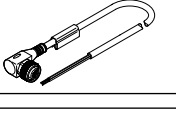
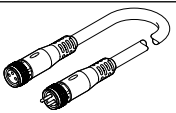
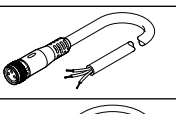
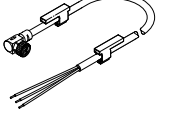
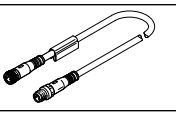
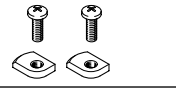
Accessories

Ordering data		Part no.	Type	
Connecting cable for valves with round plug M12x1				
Datasheets → Internet: nebu				
	Modular system for a choice of connecting cables → Internet: nebu	0.1 ... 30 m	-	
	Straight socket, 5-pin Open cable end, 4-core	2.5 m	★ 550326	
		5 m	★ 541328	
	Angled socket, 5-pin Open cable end, 4-core	2.5 m	550325	
		5 m	541329	
Connecting cable for electrical connection of the switching status sensor				
	Modular system for a choice of connecting cables → Internet: nebu	0.1 ... 30 m	-	
	Straight socket, M8x1, 3-pin Open end, 3-core	2.5 m	★ 541333	
		5 m	★ 541334	
	Angled socket, M8x1, 3-pin Open end, 3-core	-	2.5 m	★ 541338
			5 m	★ 541341
		Rotatable socket	2.5 m	8001660
			5 m	8001661
	Straight socket, M8x1, 3-pin Straight plug M8x1, 4-pin	2.5 m	554037	
H-rail mounting				
	For end plate, valve size 18 mm	Pack of 2	553996	
	For end plate, valve size 26 mm	Pack of 2	553995	
User documentation				
	Valve manifold assembly VTIA	German	538928	
		English	538929	
		French	538931	
		Spanish	538930	
		Italian	538932	